

Owner's Manual

8288 429 000

Model VR8000

Digital Multitrack Recorder

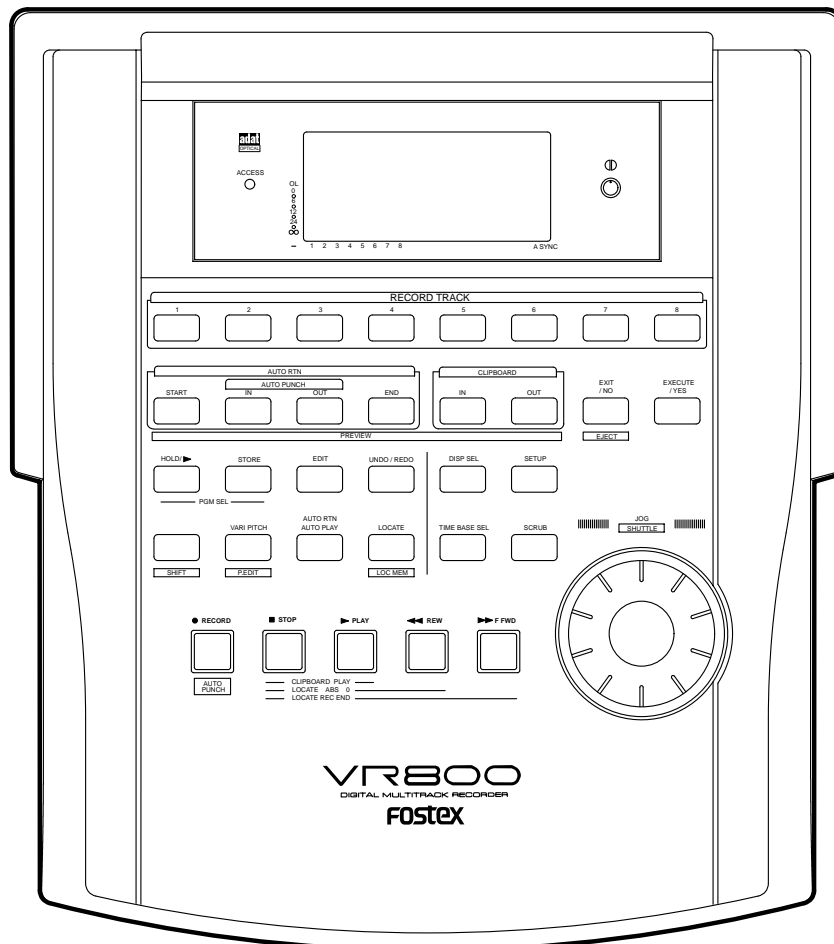

Fostex®

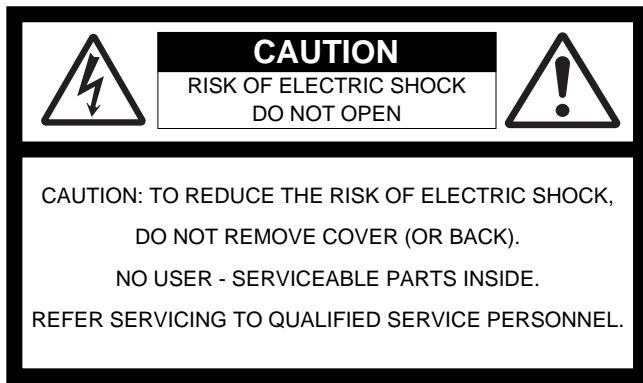

"WARNING"

"TO REDUCE THE RISK OF FIRE OR ELECTRIC SHOCK, DO NOT EXPOSE THIS APPLIANCE TO RAIN OR MOISTURE."

SAFETY INSTRUCTIONS

1. Read Instructions - All the safety and operating instructions should be read before the appliance is operated.
2. Retain Instructions - The safety and operating instructions should be retained for future reference.
3. Heed Warnings - All warnings on the appliance and in the operating instructions should be adhered to.
4. Follow Instructions - All operating and use instructions should be followed.
5. Water and Moisture - The appliance should not be used near water - for example, near a bathtub, washbowl, kitchen sink, laundry tub, in a wet basement, or near a swimming pool, and the like.
6. Carts and Stands - The appliance should be used only with a cart or stand that is recommended by the manufacturer.



An appliance and cart combination should be moved with care. Quick stops, excessive force, and uneven surfaces may cause the appliance and cart combination to overturn.

7. Wall or Ceiling Mounting - The appliance should be mounted to a wall or ceiling only as recommended by the manufacturer.
8. Ventilation - The appliance should be situated so that its location or position does not interfere with its proper ventilation. For example, the appliance should not be situated on a bed, sofa, rug, or similar surface that may block the ventilation openings; or, placed in a built-in installation, such as a bookcase or cabinet that may impede the flow of air through the ventilation openings.

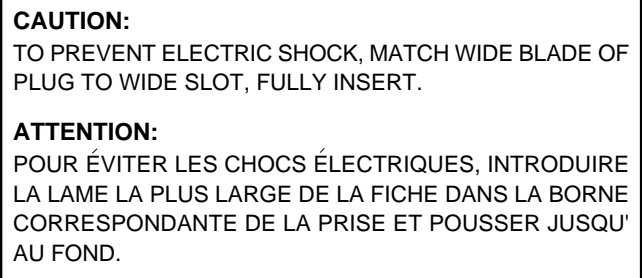

The lightning flash with arrowhead symbol, within an equilateral triangle, is intended to alert the user to the presence of uninsulated "dangerous voltage" within the product's enclosure that may be of sufficient magnitude to constitute a risk of electric shock to persons.



The exclamation point within an equilateral triangle is intended to alert the user to the presence of important operating and maintenance (servicing) instructions in the literature accompanying the appliance.

9. Heat - The appliance should be situated away from heat sources such as radiators, heat registers, stoves, or other appliances (including amplifiers) that produce heat.
10. Power Sources - The appliance should be connected to a power supply only of the type described in the operating instructions or as marked on the appliance.
11. Grounding or Polarization - The precautions that should be taken so that the grounding or polarization means of an appliance is not defeated.
12. Power Cord Protection - Power supply cords should be routed so that they are not likely to be walked on or pinched by items placed upon or against them, paying particular attention to cords at plugs, convenience receptacles, and the point where they exit from the appliance.
13. Cleaning - The appliance should be cleaned only as recommended by the manufacturer.
14. Nonuse Periods - The power cord of the appliance should be unplugged from the outlet when left unused for a long period of time.
15. Object and Liquid Entry - Care should be taken so that objects do not fall and liquids are not spilled into the enclosure through openings.
16. Damage Requiring Service - The appliance should be serviced by qualified service personnel when:
 - A. The power supply cord or the plug has been damaged; or
 - B. Objects have fallen, or liquid has been spilled into the appliance; or
 - C. The appliance has been exposed to rain; or
 - D. The appliance does not appear to operate normally or exhibits a marked change in performance; or
 - E. The appliance has been dropped, or the enclosure damaged.
17. Servicing - The user should not attempt to service the appliance beyond that described in the operating instructions. All other servicing should be referred to qualified service personnel.

Table of Contents

Introduction.....5	
Main features.....5	Rehearsing manual punch in/out recording.....40
Precautions.....6	Manual punch in/out Take.....41
Note on repair.....6	Undo/redo manual punch in/out recording.....42
About copyrights.....6	Recording to a Metronome Sound.....43
About damage.....6	Digital Recording.....45
Names and Functions.....7	Digital recording from an external digital device.....45
Top panel.....8	Digital recording to an external device.....46
Rear panel.....14	Storing a Locate Point (Edit Point).....48
Side panel.....15	Storing and editing the locate points
Display section.....16	to the memory keys49
Display when the power is turned on.....16	Storing in real-time.....49
Preset display.....16	Editing and storing locate data.....50
Display examples for time base selected via	Editing and storing data.....50
the TIME BASE SEL key.....17	Storing and editing LOCATE key.....51
Selecting time base using the DISP SEL key.....17	Storing in real-time.....51
The REMAIN display.....18	Editing and storing locate data.....52
Warning message.....19	Edit and re-store data that is already stored.....53
Before Starting.....20	Locate Function.....54
Time Base.....20	Direct Locate.....54
Recording method and REMAIN indicator.....21	Auto Play.....55
Managing songs by Program Change function.....22	Auto Return.....55
Real tracks and Additional tracks.....23	Auto Repeat.....56
Input monitoring and playback monitoring.....24	Cue & Review Function.....57
Audio file and event.....25	Cue & Review function using
Formatting a Disk.....27	the REWIND and F FWD button.....57
Recording mode.....27	Cue & Review function using the SHUTTLE feature.....57
Formatting the current drive (SCSI disk).....28	Digital scrubbing using the SCRUB function.....58
Formatting the current drive (E-IDE hard disk).....30	Preview Function.....59
Formatting a backup disk (SCSI disk).....30	Executing the Preview function.....59
Formatting a backup disk (fixed disk).....31	Trimming the sound while previewing.....60
Handling Programs.....32	Editing Tracks.....61
Creating a new Program.....32	Copy & Paste and Move & Paste.....61
Using a Program Change function.....33	Storing the edit points.....62
Deleting a Program.....34	Checking and adjusting the edit points.....62
Editing a Program title.....35	Executing Copy (or Move).....62
Punch In/Out Recording.....36	Checking the clipboard data.....62
What is Punch In/Out recording?.....36	Executing Paste.....63
Auto Punch In/Out.....36	Undo/redo Paste.....63
Preparation.....36	Erase.....64
Rehearsing auto punch in/out recording.....38	Storing the edit points.....65
Auto punch in/out Take.....39	Checking and adjusting the edit points.....65
Undo/redo auto punch in/out recording.....39	Executing Erase.....65
Manual Punch In/Out recording.....40	Undo/redo Erase.....65
preparation.....40	Track Exchange.....66
	Executing Track Exchange.....67

MIDI Sync function.....	68
MIDI clock sync system.....	68
MTC sync/MIDI Machine Control system.....	70
External MIDI equipment sync system by the slave mode.....	73
Saving and Loading Song Data.....	75
Outline of the save/load operation.....	75
Saving and loading data using a SCSI drive as the current drive.....	78
Saving/loading data using another SCSI drive.....	78
SCSI drive connection and preparation.....	78
Saving data.....	79
Loading data.....	80
Saving/loading via a DAT or adat.....	81
Saving and loading data using an 3.5-inch E-IDE hard disk as the current drive.....	82
Saving song data via a DAT or adat.....	82
DAT (or adat) connection and preparation.....	82
Saving data.....	83
Loading song data via a DAT or adat.....	84
DAT (or adat) connection and preparation.....	84
Loading data.....	85
Saving and loading song data via a SCSI drive.....	86
Quick Troubleshooting.....	87
Changing the Initial Settings (SETUP mode).....	88
Selecting SETUP mode.....	89
Setting a time signature.....	90
Setting a tempo.....	92
Setting the metronome function.....	93
Setting a preroll value.....	94
Setting MIDI sync output signal.....	95
Setting an MTC frame rate.....	96
Setting an MTC offset value.....	96
Setting MTC Offset mode.....	97
Setting the slave mode.....	98
Setting the slave type.....	99
Setting the Record Protect function.....	100
Setting digital input tracks.....	101
Setting digital output tracks.....	102
Setting BAR/BEAT resolution mode.....	103
Setting the MIDI device number.....	104
Checking the number of each track events.....	105
MIDI Implementation Chart.....	106
MMC Command List/Inquiry Message List.....	107
Fostex System Exclusive Message.....	108
Status Request.....	109
Data Type.....	111

Explanation on the command/mode list.....	113
The status request command.....	115
Explanation on the status reply.....	116
Maintenance/Specifications.....	118

Introduction

Thank you for purchasing the Fostex Model VR800. The VR800 is a 8-track digital multitrack recorder with sixteen additional tracks that employs a 3.5-inch E-IDE type removable hard disk, or external SCSI device (removable or fixed) as the recording media, instead of conventional type.

The VR800 is a digital multitrack recorder that is designed to connect to a digital mixing console using optical cables. For recording media, it uses 3.5-inch E-IDE hard disks, removable disks, such as SCSI Zip and MO drive disks, or fixed disks to provide you with a maximum of eight tracks of simultaneous recording and playback, along with 16 additional tracks.

The VR800 records uncompressed digital audio using 16-bit linear quantization, and a sampling frequency of 44.1kHz, which enables you to configure a completely digital recording system that combines various digital mixers. Adopting A.D.A.C (*) has expanded the disk recording capacity by a factor of four. You can select one of three recording modes, depending on the recording media and application.

You can back up data to DAT tapes or to an adat using a special adat back-up function. SCSI ports permit fast back-up.

Using an optional Model VC-8 (adat-analog converter) allows you to connect an analog mixer to the VR800. Please read this Owner's Manual and the Quick Operation Guide.

Main features

The VR800's recorder section uses a recording format called FDMS-3 (Fostex Disk Management System-3). It uses an 3.5-inch E-IDE hard disk, external SCSI device (stationary disk or removable disk) as the recording media.

- The VR800 features a 3.5-inch bay for easy installation of a 3.5-inch E-IDE hard disk. A SCSI connector enables you to connect a SCSI device (removable or fixed) as the current or back-up drive.
- The VR800 features non-destructive audio editing (a great advantage of digital recording) such as Copy & Paste, Move & Paste, Erase, etc. You can choose Time Base (ABS or MTC) or MIDI bar/beat/clock as the unit.
- A "Preview function" allows for an intuitive fine-adjustment of an editing point (locate point).

- An "Undo/Redo function" enables you to easily correct recording and editing mistakes.
- A "Vari Pitch function" allows you to fine-tune the pitch.
- The VR800 has a "digital input track setup" function that enables you to input S/P DIF or adat digital signals and record them on any two tracks or all eight tracks.
- The VR800 has a "digital output track setup" function that enables you to output digital data as S/P DIF or adat digital signals and record them on an external digital device (DAT, MD, adat, etc.).
- You can also use the DATA IN/OUT jacks to an external DAT or adat, and to save and load song data (audio data and SETUP mode settings) to and from the DAT or adat.
- High-speed SCSI Save/Load is also an option by connecting a non-DAT or adat SCSI backup drive.
- A maximum of 99 Locate Pointers can be programmed for a LOCATE only feature. Simply select the LOCATE number desired for swift location.
- MIDI clock and Song Position Pointer can be transmitted according to the internal programmable Tempo Map. You can set up a synchronization system with a sequencer or a rhythm machine without wasting a track.
- You can use the VR800 as a sync slave machine by sending MTC from a connected device.
- The VR800 supports MTC, MMC, and Fostex System Exclusive Message, which allows for advanced control and high-precision synchronization from external sequencing software. You can set the device number and MTC frame rate for MMC and Fostex System Exclusive Message. Also, "MTC Offset function" and "Offset Mode function" are useful for setting up a sync environment using an external sequencing software.
- Auto Punch In/Out and Manual Punch In/Out functions offer two modes: "Take" for a real recording, and "Rehearsal" for monitoring the part between the in and out points.
- The "Program Select function" enables you to select a song from up to 99 songs and name the songs.
- A "Bar/Beat Resolution function" is used to edit audio at the beginning of the beat (round up or round off to a beat).
- The "Metronome function" can be used as a rhythm guide for recording.
- Various edit functions using an edit point (locate point), such as Copy & Paste, Move & Paste, Erase, Auto Punch In/Out, Auto Locate, are available. You can also locate ABS 0 or REC END regardless of the edit point (locate point).
- You can set a preroll time of 0 to 10 seconds.
- A "Disk Remain Display function" offers a clear indication of available recording time and disk space (in mono track recording). You can choose the Time Base from ABS, MTC, and BAR/BEAT/CLK.

Precautions

- Be sure to connect the VR800 to the power supply specified in the Specifications section of this Owner's Manual. Do not use an AC outlet of any other voltage.
- Do not connect the VR800 to the same AC outlet to which devices that could generate noise (such as a large motor or dimmer), or the devices that consume a large amount of power (such as an air conditioning system or large electric heater) are connected.
- If you use the unit in an area with a different power voltage, first consult your dealer or the nearest FOSTEX service station. You can use the unit with a power frequency of 50Hz or 60Hz.
- It is very dangerous to use a power cord that is frayed or damaged. In such a case, stop using the unit immediately and ask your dealer to repair the cord.
- To avoid possible electric shock and damage to the VR800, avoid contact with water or other liquids, or do not handle the power plug while your hands are wet.
- To prevent possible electric shock and damage to the VR800, do not remove the main unit cover or reach the inside the unit.
- Do not let water or other liquid, or metal objects such as pins, accidentally enter the inside of the unit because this may lead to electric shock or damage. Should water enter the inside of the unit, remove the power plug from the AC outlet, and consult your dealer or the nearest FOSTEX service station.
- To prevent damage to the VR800, be sure to power on the connected devices first, then turn on the power to the VR800.
- Before turning the power off to the VR800, first quit Setup mode and make sure that the recorder section is stopped. Especially, never attempt to turn off the power to the unit while the hard disk is accessing data (the HD ACCESS LED is lit or flashing). Otherwise, not only will you lose recorded data, but you may damage to the unit. FOSTEX is not responsible for the data lost during operation of the unit.
- Before you change the location of the VR800, pack the unit in the shipping carton or an impact-resistant case. Make sure that the unit is kept free from external vibration or impact since the unit is very sensitive to vibration.
- Do not install the unit in locations subject to the following:
 - * Extremely high or low temperature, or significant changes in temperature.
 - * Excessive humidity or dust.
 - * Excessive changes in power supply voltage
 - * Unstable or significantly vibrating or shaking surfaces.
 - * Near a strong magnetic field (such as a TV or speaker).

- If you move the unit from a place with an excessively low temperature to a warm place, or if you use the unit in a room in which the temperature varies significantly during winter, condensation may occur on the hard disk or other parts. In such cases, leave the unit for about an hour in the new location before you turn on the power.

Note on repair

- This unit does not use any parts that users can repair easily. Contact your dealer or the nearest FOSTEX service station to ask about repairs.
- Use the packing carton designed for the VR800 when you transport the unit to the dealer for repair or return. If you have discarded the packing box, try to pack the unit completely using shock absorbing materials. Fostex is not responsible for malfunction or damage due to incomplete packaging or caused during transport.

About copyrights

- It is prohibited by law to use any part of a CD recording or video images or audio data for which copyright is possessed by a third party for commercial purposes such as contents, broadcasts, sales, or distribution- any purpose other than for your personal pleasure.

About damage

- FOSTEX is not responsible for any "direct damage" or "indirect damage" caused by using the VR800.

Names and Functions

Rear panel

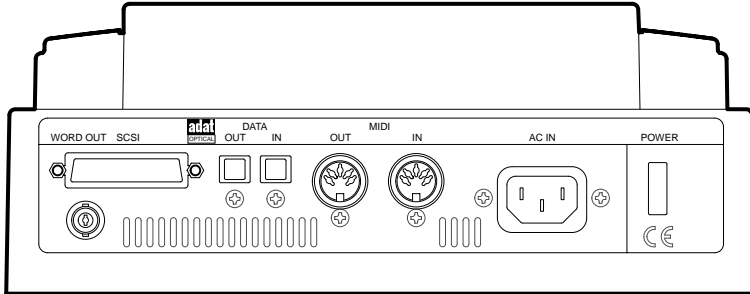

Top panel

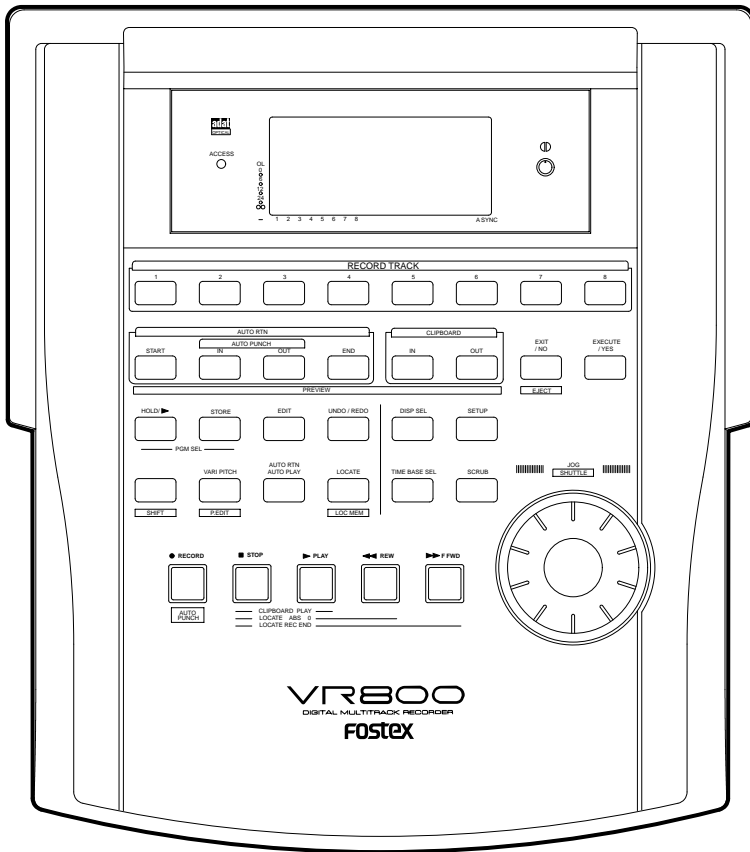

Side panel

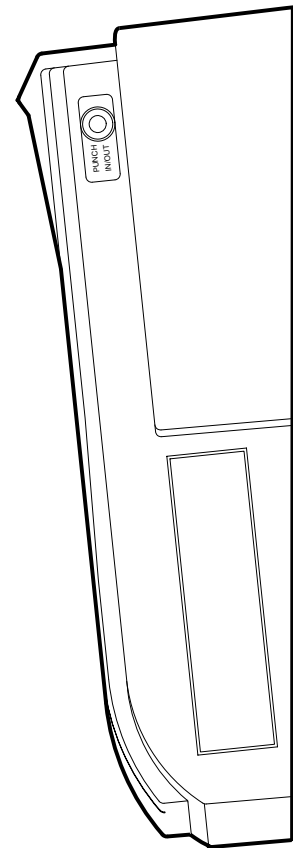

Top Panel Letters in brackets ([]) are labels on the panel.

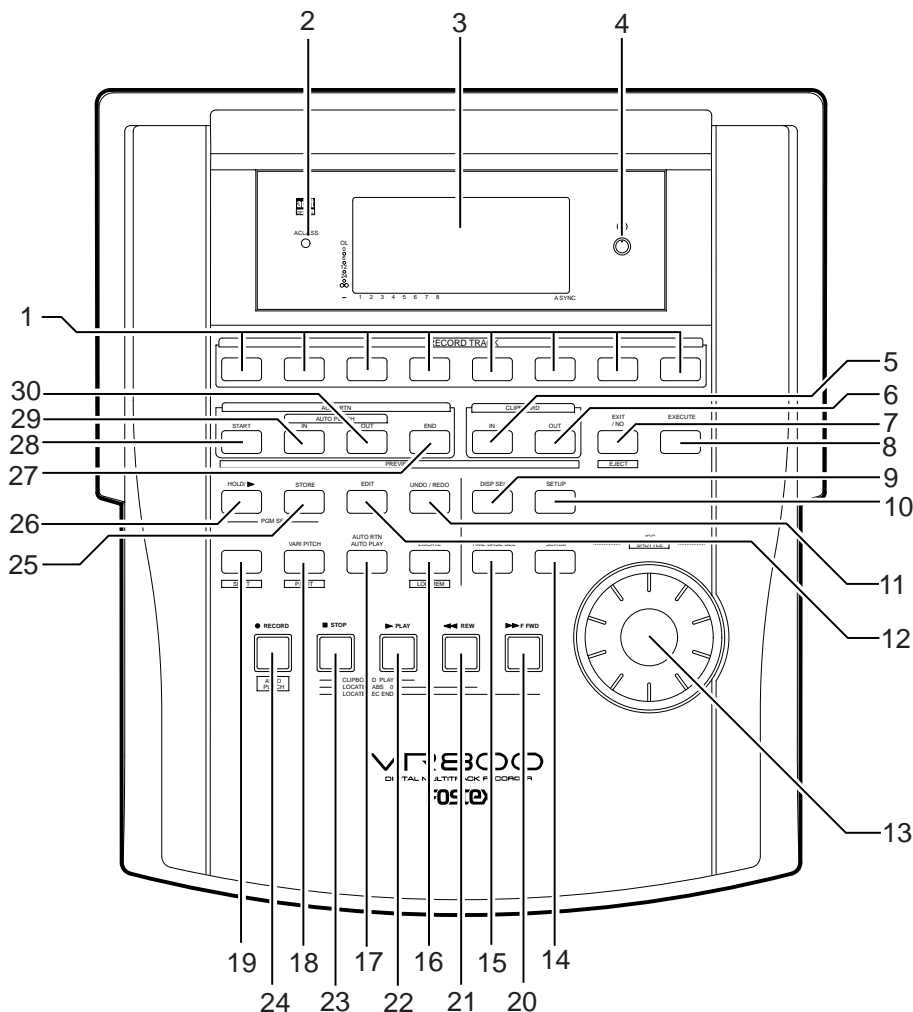

1. Record track select keys [RECORD TRACK (1 - 8)]

These keys enable you to select SAFE or READY for a recording track. Pressing the key once will cause the corresponding track to enter the READY mode, and the lamp of the key you pressed to flash. Pressing the key again will cause the corresponding track to enter the SAFE mode, and the lamp to turn off. When you start recording on a track in READY mode, the flashing lamp remain lit.

If you press only the RECORD button with a track in READY mode, you can monitor the signal input to the READY track so that you can adjust the recording level. To cancel this input monitoring status, press the RECORD button again. This puts the VR800 in playback monitoring mode.

You can also use these select keys to select tracks to Copy & Paste, Move & Paste, Erase and other editing features, as well as to execute the digital scrubbing.



Refer to page 24 for more information on playback monitoring and input monitoring.

2. Access LED [ACCESS]

This LED light up or flashes when data is being written to or read from an external SCSI current drive disk, or 3.5-inch internal E-IDE hard disk.



Note: Do not turn off the power to the VR800 when this LED lights up or flashes. Otherwise you may lose data on the hard disk connected to the VR800.

3. LCD

The LCD indicates signal levels and various settings.



Refer to "Display Section" on page 16 for more information on the display.



Note: You can record on real tracks 1–8 in real-time, but not on additional tracks 9–24. If you are using an MO drive as the current drive, you can record only two tracks simultaneously. If you try to record more than two tracks by setting them to READY mode, [Track Over !] appears and READY mode will cancel.

4. Contrast adjustment knob

Use this knob to adjust the contrast of the LCD. Turning this knob clockwise will increase the contrast, and turning it counter-clockwise will decrease the contrast.



Note: The display is not unreadable if you leave the knob counter-clockwise all the way.

5. Clipboard In key [CLIPBOARD IN/ [PREVIEW]]

Use this key to store the start point of audio data to be copied or moved. When you press this key, the VR800 displays data currently stored, and you can edit the data. After editing the data, press the STORE key, then press the CLIPBOARD IN key to store the edited data in this key. The stored data can be used as locate data.

If you press the CLIPBOARD IN key while holding down the SHIFT key when the recorder is stopped, you can preview the fade-in part at the stored CLIPBOARD IN point.



- * Refer to page 51 for more information on setting and editing the locate point.
- * Refer to page 61 for more information on the Copy & Paste/ Move & Paste functions.
- * Refer to page 59 for more information on previewing data at the CLIPBOARD IN point

6. Clipboard Out key [CLIPBOARD OUT/ [PREVIEW]]

Use this key to store the end point of audio data to be copied or moved. When you press this key, the VR800 displays currently-stored data, which you can edit. After editing the data, press the STORE key, then press the CLIPBOARD OUT key to store the edited data in this key. The stored data can be used as locate data.

If you press the CLIPBOARD OUT key while holding down the SHIFT key when the recorder is stopped, you can preview the fade-out part at the stored CLIPBOARD OUT point.



- * Refer to page 51 for more information on setting and editing the locate point.
- * Refer to page 61 for more information on the Copy & Paste/ Move & Paste functions.
- * Refer to page 59 for more information on previewing data at the CLIPBOARD OUT point

7. Exit/No key [EXIT/NO/ [EJECT]]

This key is the counterpart of the EXECUTE/YES key. Press this key to cancel an operation. When you use a removable SCSI disk, pressing this key while holding down the SHIFT key will eject the disk.

8. Execute/Yes key [EXECUTE/YES]

Press this key to confirm the edit operations, such as Copy & Paste, Move & Paste, and Erase, and to set the parameters of SETUP menus.

9. Display indication select key [DISP SEL]

Pressing this key each time will change the display indication as follows:

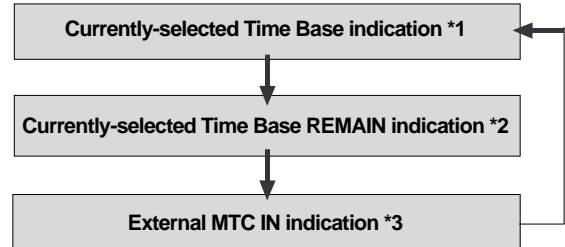

***1** The current position in terms of time base selected via the TIME BASE SEL key appears. ABS time, MTC time, or BAR/BEAT/CLK is used.

***2** Available recording time and space on the current SCSI disk will appear. The time indication uses the currently-selected time base (ABS, MTC, or BAR/BEAT/CLK). The space indication uses MB (Megabyte). (The values are based on mono track recording.)

***3** MTC being input from an external MIDI device to the VR800 appears. If no MTC is input, the display will show "00H 00M 00S 00F."

10. Setup key [SETUP]

Press this key to set the VR800 in SETUP mode to execute various menus. This key works only when the VR800 is stopped.



Refer to page 88 for more information on SETUP mode.

11. Undo/Redo key [UNDO/REDO]

If you wish to restore the status prior to editing, recording, or performing a punch in/out take, press the UNDO/REDO key. Pressing the UNDO/REDO key again will restore the status obtained before you pressed the UNDO/REDO key the first time.

When you undo the operation, [Undo!] will appear. When you redo the operation, [Redo!] will appear on the display.



Note: The Undo/Redo function works only when the VR800 is stopped.



Refer to pages 39, 42, 63, 65 and "Quick operation guide" for more information on the Undo/Redo function.

12. Edit key [EDIT]

Pressing this key enters the VR800 to the menu select mode for editing tracks, and displays the title of the menu you used last time. Press this key repeatedly or turn the JOG dial to select a menu. The edit menus appear in the following order. To execute a desired menu, select the menu, then press the EXECUTE/YES key.

To exit selection mode, press the EXIT/NO key.

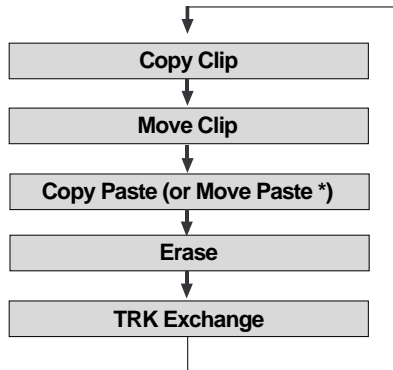

(*) After you execute copy clip, "Copy Paste" appears. After you execute move clip, "Move Paste" appears.



- * Refer to page 61 for more information on Copy & Paste and Move & Paste.
- * Refer to page 64 for more information on Erase.
- * Refer to page 66 for more information on Track Exchange.

13. JOG dial [JOG/SHUTTLE]

When the VR800 is stopped, use the JOG dial to perform a jog operation (forward or reverse) for audio scrubbing without pitch change. You can also use this dial to increase and decrease the numeric values or input alphabetical characters in edit mode.

Rotating the JOG dial while holding down the SHIFT key will enable you to perform the shuttle operation with different speeds ranging from normal speed to 64-times speed.



Refer to page 57 for more information on the cue/review function and the shuttle function.

14. Scrub key [SCRUB]

Pressing this key causes its lamp to light up as the VR800 will enter the digital scrub mode. At this point, press the desired RECORD TRACK select key to digitally scrub the selected track playback using the JOG dial.



Refer to page 58 for more information on Digital Scrub mode.

15. Time Base select key [TIME BASE SEL]

Pressing this key repeatedly will switch time base as follows:

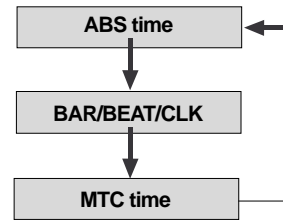

16. Locate key [LOCATE/LOC MEM]

Use this key to start the LOCATE feature.

Pressing this key after a memory key (CLIPBOARD IN/OUT, AUTO RTN START/END, AUTO PUNCH IN/OUT) locates the memory data programmed in each respective key (time mode or bar, beat, clock setting).

The data can be programmed by individually setting it with one of the 99 (01-99) locate numbers of the LOCATE key.

Note that the data of locate number 00 is available in addition to locate numbers 01-99. The last locate time setting (bar, beat, clock setting) constantly replaces the data stored in the LOCATE key as data in locate number 00. Therefore, it is possible to press this key alone to repeatedly locate the same point.

Pressing the LOCATE key while holding down the SHIFT key will cause the VR800 to enter edit mode, in which you can edit data stored in the LOCATE key.



- * Refer to page 54 for more information on the Locate function.
- * Refer to page 51 for more information on editing data using the LOCATE key.

17. Auto Return/Auto Play mode on/off key [AUTO RTN/AUTO PLAY]

Use this key to turn on and off auto return mode, auto play mode, and auto repeat mode. Each time you press the key, the mode will change and the following indication displayed.

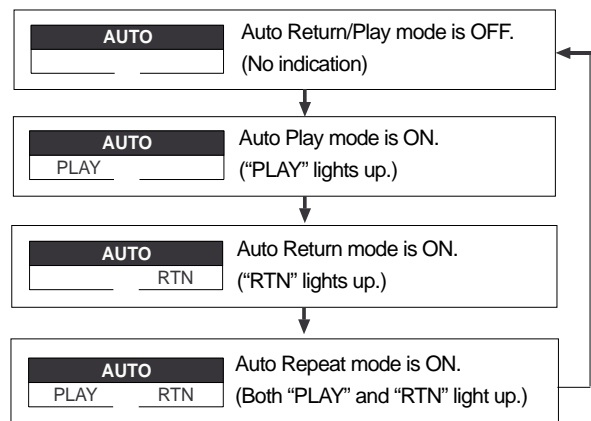

* Auto Play mode

The VR800 locates a point and starts playing from the locate point.

*** Auto Return mode**

When the AUTO RTN END point is reached while the recorder section is playing, the VR800 automatically locate the AUTO RTN START point. This mode is effective only if the AUTO RTN START point and the AUTO RTN END point have already been specified.



Note: The auto return function is enabled only when the VR800 is playing. While the VR800 is recording, the VR800 will not locate the START point after it reaches the AUTO RTN END point.

***Auto Repeat mode**

This mode is effective only when auto play mode and auto return mode are turned on. The VR800 will play the part between the AUTO RTN START point and the AUTO RTN END point repeatedly. This mode is also effective only if the AUTO RTN START point and the AUTO RTN END point have already been specified.



Refer to page 54 for more information on each mode.

18. Vari Pitch key [VARI PITCH/ [P.EDIT]]

This key toggles vari pitch mode on and off. When vari pitch mode is on, the "VARI PITCH" indicator lights up on the display, and the VR800 plays using the current pitch data. Pressing the VARI PITCH key while holding down the SHIFT key will cause the VR800 to enter edit mode, in which you can change pitch data in real-time. To exit edit mode, press the EXIT/NO key.



Refer to Quick operation guide for more information on playing with Vari Pitch and editing Vari Pitch data.

19. Shift key [[SHIFT]]

Press a key, button, or turn the dial while holding down the SHIFT key to activate the following "shift-invoked" functions.

You can audition the data at edit points (locate points) stored in the memory keys. (For more information, refer to "Preview function" on page 59.)

The removable SCSI disk is ejected. (Refer to "Formatting a disk" on page 31.)

The SHUTTLE function is activated. (Refer to "Cue & review function using the SHUTTLE function" on page 57 for more information.)

Auto punch mode turned on and off. (Refer to "Punch In/Out" on page 36.)

You can edit Vari Pitch data. (Refer to Quick operation guide for more information on "Playback in Vari Pitch mode".)

You can edit locate data stored in the LOCATE key. (Refer to "Storing an edit point (locate point)" on page 48 for more information.)

20. Fast forward button [F FWD]

Pressing this button while the VR800 is stopped will start fast forwarding at low speed at first, then gradually accelerate to 30-times speed. If you press this button while the VR800 is playing, cueing (fast forwarding with sound) starts at three-time speed. Pressing this button while holding down the STOP button will activate the "LOCATE REC END" operation, which will locate the end point of the recording on the real track in the current program. You can also use this button to locate an edit point in edit mode.



Refer to the "STOP button" section and page 48 for more information on the "LOCATE REC END" operation.

21. Rewind button [REWIND]

Pressing this button while the VR800 is stopped will start rewinding at low speed at first, and then gradually increase speed up to 30-times speed. If you press this button while the VR800 is playing, cueing (rewinding with sound) starts at three-times speed. Pressing this button while holding down the STOP button will activate the "LOCATE ABS 0" operation, which will locate the beginning of the current program (ABS time: 00m 00s 00f). You can also use this button to locate an edit point in edit mode.



Refer to the "STOP button" section and page 48 for more information on the "LOCATE ABS 0" operation.

22. Play button [PLAY]

Pressing this button causes the recorder section to play back. Pressing this button while holding down the RECORD button when a track is in READY mode will cause the VR800 to start recording on the READY track. Pressing only this button during the recording operation will punch-out (cancel) recording. Pressing this button while holding down the STOP button will cause the "CLIPBOARD PLAY" operation to start.



- * Refer to the "STOP button" section and page 62 for more information on the "CLIPBOARD PLAY" operation.
- * Refer to page 41 for more information on the Punch Out operation using the PLAY button.

23. Stop button [STOP]

Pressing this button during the playback, recording, fast forward, or rewind operation will stop the recorder transport operation. Pressing this button while the VR800 is in SETUP mode will cause the unit to exit SETUP mode. Pressing the PLAY, REWIND, or F FWD button while holding down the STOP button will start the following operations. If you wish to rehearse the manual Punch In/Out operation using the foot switch, press the foot switch while holding down this button to enter the rehearsal mode.

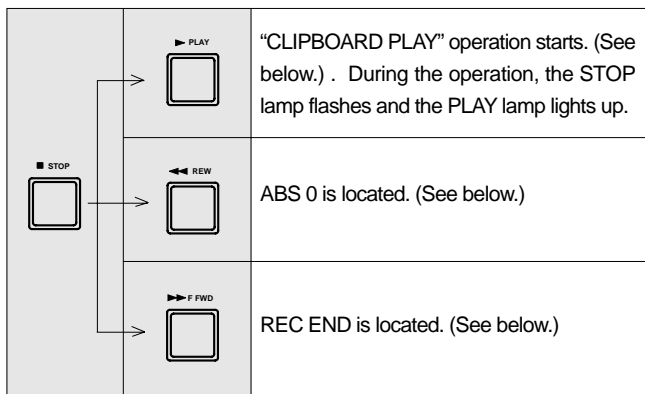

*** CLIPBOARD PLAY operation**

The CLIPBOARD PLAY operation plays back data on the clipboard. (If the clipboard does not contain any data, the display shows [Void Data !] and nothing happens.). During this operation, the display indicates the type of the data ("Copy Clip" for copy data, and "Move Clip" for move data), and the duration. The indicator of the copy source or move source track will flash. This way, you will know which track the currently playing data comes from and why the data is on the clipboard.

*** ABS 0 locate operation**

This operation locates the beginning of the current program (ABS time: 00m 00s 00f).

*** REC END locate operation**

This operation locates the end of the audio recording (REC END) on the real track in the current program.



- * Refer to page 54 for more information on these operations.
- * Refer to page 40 for more information on the Punch In/ Out operation using a foot switch.

24. Record button [RECORD/ AUTO PUNCH]

Pressing the PLAY button while holding down this button will start the VR800 recording any READY tracks.

The flashing lamp of the RECORD TRACK select key for the corresponding READY track will light steadily, and the PLAY lamp and the RECORD lamp light.

If you press only the RECORD button, a READY real track enters input monitoring mode (The RECORD lamp flashes.). At this time, pressing the RECORD button again will cancel the input monitoring mode, and the track will return to the playback monitoring mode.

Pressing the RECORD button while holding down the SHIFT key will toggle between AUTO PUNCH on and off.



- * Refer to page 36 for more information on AUTO PUNCH mode.
- * Refer to page 24 for more information on input monitoring and playback monitoring.

25. Store key [STORE]

This is the key for registering (storing) the time (or BAR/BEAT/CLK figures) for ABS or MTC into any memory key or LOCATE key. The key lamp will be lit when this is pressed and together with a display of [Press LOC:], the locate number will blink. When registering time data in a memory key such as AUTO PUNCH IN, any memory key can be pressed by ignoring this [Press LOC:] display, when registering in the LOCATE key, specify any locate number (01~99) while [Press LOC:] is displayed, then press the LOCATE key. In either case, the STORE key lamp will be extinguished simultaneous with the completion of time data registering, and return to the original time base display. After pressing this key, if you wish to cancel the store operation, press the EXIT/NO key, or STOP button.

Press the STORE key, and press the CLIPBOARD IN key.

The CLIPBOARD IN point will be stored.
This data can be used as locate data.

Press the STORE key, and press the CLIPBOARD OUT key.

The CLIPBOARD OUT point will be stored.
This data can be used as locate data.

Press the STORE key, and press the AUTO PUNCH IN key.

The AUTO PUNCH IN point will be stored.
This data can be used as locate data.

Press the STORE key, and press the AUTO PUNCH OUT key.

The AUTO PUNCH OUT point will be stored.
This data can be used as locate data.

Press the STORE key, and press the AUTO RTN START key.

The AUTO RTN START point will be stored.
This data can be used as locate data.

Press the STORE key, and press the AUTO RTN END key.

The AUTO RTN END point will be stored.
This data can be used as locate data.

Specify locate number and press LOCATE key

The specified locate number will be stored as locate data.
A maximum 99 locate numbers can be registered.

If you press the STORE key and the HOLD/> key simultaneously while the recorder is stopped, the VR800 will enter the program select mode, in which you can select a program or set up a new one.



- * Refer to page 54 for more information on the Locate function.
- * Refer to page 48 for more information on storing edit points (locate points).
- * Refer to page 32 for more information on the Program Select function.

26. Hold/> key [HOLD/>]

Pressing the HOLD/> key while the recorder is operating will cause the VR800 to capture the time when you pressed it (or bar/beat/clock value), display it, and then enter edit mode. (If you press the HOLD/> key while the recorder section is stopped, the VR800 enter edit mode directly.)

To cancel edit mode, press the STOP button, DISP SEL key, or the EXIT/NO key.

In edit mode, you can use this key to select a digit of the value to edit (edit point). You can select a digit which flashes on the display) in the following order.

ABS or MTC is used as time base:
 First, "S" (second) flashes. Each time you press the HOLD/> key, the flashing characters change in this order: F -> SF -> H -> M -> S.

BAR/BEAT/CLK is used as time base:
 First, "BAR" flashes. Each time you press the HOLD/> key, the flashing indicator changes in this order: ♪ -> CLK -> BAR.

If you press the HOLD/> key and the STORE key simultaneously while the recorder is stopped, the VR800 will enter the program select mode, in which you can select a program or set up a new one.



- * Refer to page 48 for more information on editing memory.
- * Refer to page 32 for more information on the Program Select function.

27. Auto Return End key [AUTO RTN END/ PREVIEW]

Use this key to store the start point (AUTO RTN END point) for the auto return function and the auto repeat function. When you press this key, the VR800 will display currently-stored data, which you can edit. After editing the data, press the STORE key, then press the AUTO RTN END key to store the edited data in this key. The stored data can be used as locate data.

If you press the AUTO RTN END key while holding down the SHIFT key when the recorder is stopped, you can preview the fade-out part at the stored AUTO RTN END point.



- * Refer to page 48 for more information on setting and editing the locate point.
- * Refer to page 54 for more information on the Auto Return and Auto Repeat functions.
- * Refer to page 59 for more information on previewing data at the AUTO RTN END point.

28. Auto Return Start key [AUTO RTN START/ PREVIEW]

Use this key to store the start point (AUTO RTN START point) for the auto return function and the auto repeat function. When you press this key, the VR800 displays the currently-stored data, which you can edit. After editing the data, press the STORE key, then the AUTO RTN START key to store the edited data in this key. The stored data can be used as locate data.

This memory is reset to the factory default value when you turn off the power to the VR800.

If you press the AUTO RTN START key while holding down the SHIFT key when the recorder is stopped, you can preview the fade-in part at the stored AUTO RTN START point.



- * Refer to page 48 for more information on setting and editing the AUTO RTN START point.
- * Refer to page 54 for more information on the Auto Return and Auto Repeat functions.
- * Refer to page 59 for more information on previewing data at the AUTO RTN START point.

29. Auto Punch In key [AUTO PUNCH IN/ PREVIEW]

Use this key to store the punch in (recording start) point for the auto punch In/Out function. The stored data is also used as a paste start point (for Copy & Paste, Move & Paste) and as an erase start point.

When you press this key, the VR800 will display currently-stored data, which you can then edit. After editing the data, press the STORE key, then the AUTO PUNCH IN key to store edited data in this key. The stored data can be used as locate data.

If you press the AUTO PUNCH IN key while holding down the SHIFT key when the recorder is stopped, you can preview the fade-out part at the stored AUTO PUNCH IN point.



- * Refer to page 48 for more information on setting and editing the locate point.
- * Refer to page 36 for more information on the Auto Punch In/Out functions.
- * Refer to page 59 for more information on previewing data at the AUTO PUNCH IN point.

30. Auto Punch Out key [AUTO PUNCH OUT/ PREVIEW]

Use this key to store the punch out (recording end) point for the auto punch In/Out function. The stored data is also used as an erase end point.

When you press this key, the VR800 will display currently-stored data, which you can then edit. After editing the data, press the STORE key, and then the AUTO PUNCH OUT key to store the edited data in this key. The stored data can be used as locate data.

If you press the AUTO PUNCH OUT key while holding down the SHIFT key when the recorder is stopped, you can preview the fade-in part at the stored AUTO PUNCH OUT point.



- * Refer to page 48 for more information on setting and editing the locate point.
- * Refer to page 36 for more information on the Auto Punch In/Out functions.
- * Refer to page 59 for more information on previewing data at the AUTO PUNCH OUT point.

Rear Panel

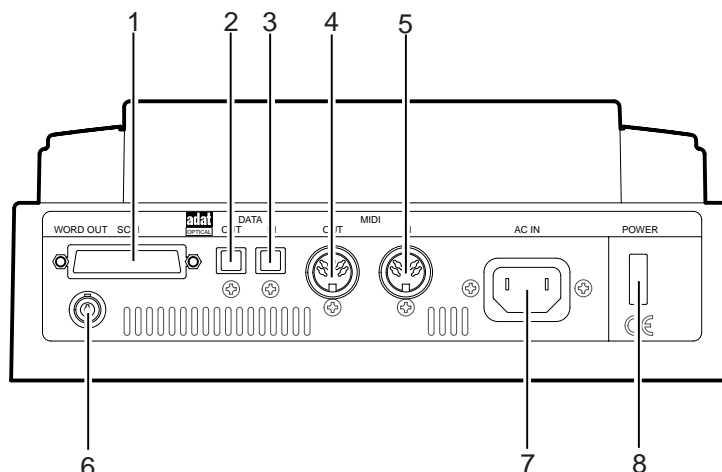

1. SCSI connector [SCSI] (Connector: D-SUB 25-pin)

Connect a SCSI device as a current drive or backup device to SAVE/LOAD data. Up to two SCSI devices can be connected to the SCSI connector. This means the current drive and backup SCSI equipment can be connected in a chain.

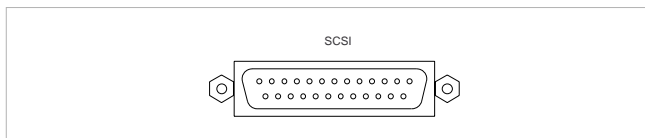

- * Refer to the "Quick Operation Guide" for information on connecting an external SCSI drive.
- * Refer to page 75 for more details on SAVE/LOAD using a SCSI device.

2. Data output jack [DATA OUT] (Connector: OPTICAL)

This is connected to the OPTICAL digital input of the external digital mixer. This is also connected to the OPTICAL digital input (or adat in) of the external digital equipment in use when digital recording in external digital equipment (MD, DAT, CD-R, etc.) from the VR800 or when saving song data in external DAT or adat.

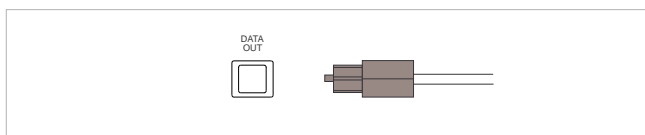

- * Refer to the "Quick Operation Guide" for more information on connecting the external digital mixer.
- * Refer to page 45 for more information on digital recording to external digital device.
- * Refer to page 75 for more information on saving and loading song data.



Note: You can save the data recorded on the current drive formatted in [Master 8ch] mode and [Master 4ch] mode to a DAT. You cannot save data recorded in [ADAC 8ch] mode. You can save only the data recorded on the current drive formatted in [Master 8ch] mode to a adat.

3. Data input jack [DATA IN] (Connector: OPTICAL)

This is connected to the OPTICAL digital output of the external digital mixer. This is also connected to the OPTICAL digital output (or adat out) of any external digital equipment in use when digitally recording on the VR800 from external digital equipment (MD, DAT, CD, adat, etc.).

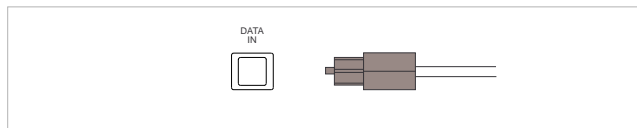

- * Refer to the "Quick Operation Guide" for more information on connecting the external digital mixer.
- * Refer to page 45 for more information on digital recording to external digital device.
- * Refer to page 75 for more information on saving and loading song data.



Note: You can load the data recorded on the current drive formatted in [Master 8ch] mode and [Master 4ch] mode from a DAT. You cannot load data recorded in [ADAC 8ch] mode from a DAT. You can load only the data recorded on the current drive formatted in [Master 8ch] mode from a adat.

4. MIDI OUT jack [MIDI OUT] (Connector: DIN 5-pin)

Connect this jack to the MIDI IN jack of an external MIDI device. This jack transmits MTC (MIDI timecode), MIDI clock & Song Position Pointer, MMC (MIDI Machine Control) command, response, and FEX (Fostex System Exclusive Message) response.

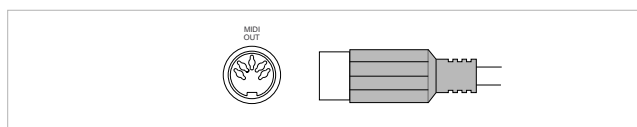

Refer to page 68 for more information on the example of using the MIDI OUT jack.

5. MIDI IN jack [MIDI IN] (Connector: DIN 5-pin)

Connect this jack to the MIDI OUT jack of an external MIDI device. You can control the VR800 remotely by inputting MMC (MIDI Machine Control) command or FEX (Fostex System Exclusive Message) here.

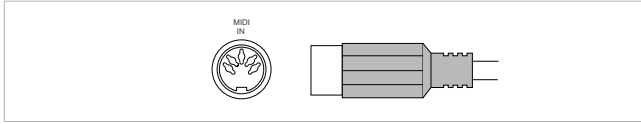

Refer to page 68 for more information on using the MIDI IN jack.

7. AC IN connector

The power cable packaged with this recorder is connected here.



Note: Always plug the power cable to the recorder before plugging the cable into the wall outlet.

8. Power switch [POWER]

This switch turns power on and off to the VR800.

6. Word Out jack [WORD OUT] (Connector: BNC)

Word clock signal from the VR800 is output here. This jack and WORD IN of the external digital equipment must be connected if the WORD IN connector is provided in the external digital equipment (digital mixer, etc.) which is connected to the VR800.



Refer to the separate "Quick Operation Guide" for operating procedures.

Side Panel

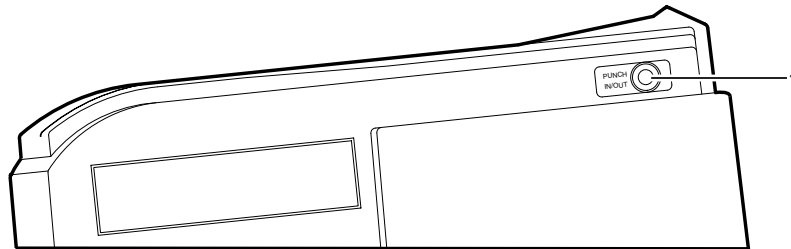

1. Punch in/out jack [PUNCH IN/OUT] (Connector: phone)

Using an optional foot switch connected to this jack enables you to perform the manual punch In/Out operation (including rehearsal) using your foot. Connect an optional Fostex foot switch, Model 8051.

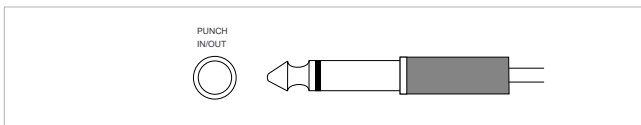

Refer to page 40 for more information on using the PUNCH IN/OUT jack.



Note: Be sure to use an "unlatch type" foot switch if you use a foot switch other than the Model 8051. Otherwise, a malfunction could occur.

Display Section

The VR800 uses a liquid crystal display which integrates a 9-digit/35-dot message section, 7-segment display section, and level meters. The level meters indicate the output level of tracks 1-8.

The time display shows various information in different units, such as ABS time (absolute time), MTC (MIDI timecode), BAR/BEAT/CLK (bar/beat/clock), and makes it easy to check the recorder's current time. The message display shows various messages required to operate the VR800, and offers interactive operation. This section describes display functions along with examples.

Display when the power is turned on

When you turn on the power to the VR800 and the connected external SCSI drive (a formatted removable disk or hard disk), the display shows the [Initial...] message, [Current Dr], the name of the connected current drive, then recording mode (Master 8ch, Master 4ch, or ADAC 8ch), and finally the top position of the disk in the time base (ABS, MTC, or BAR/BEAT/CLK) used in the last program before you turned the power off.

The following example indicates that the VR800 started with the ABS time base used in program 1.



When the VR800 recognizes the current drive, the [SCSI] indicator lights up in the [DRIVE] section of the display if the current drive is a SCSI device. The [IDE] indicator lights up if the current drive is an E-IDE hard disk.

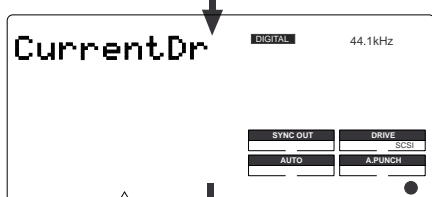

The name of the SCSI drive (The name is different, depending on the type of device.)

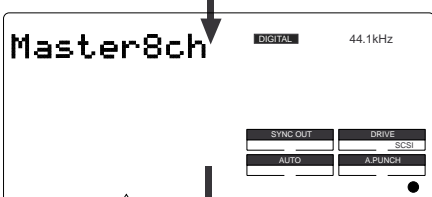

Indicating a recording mode used during formatting.

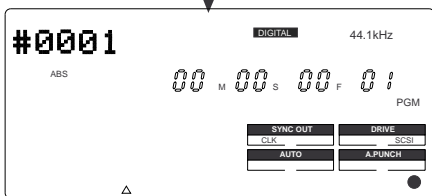

Indicating time base ABS 0 (top of the disk)

Preset display

The display below shows all preset items for explanation purposes.

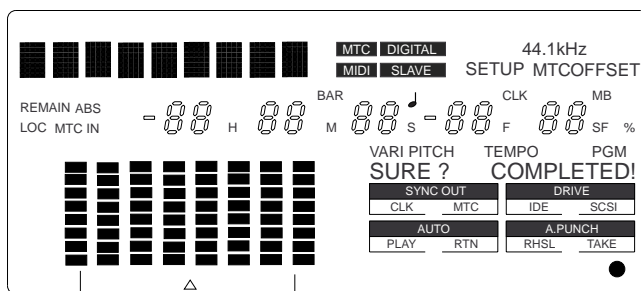

The level meter shows the recorder output level and the recording level for tracks 1-8.

ABS	Lights up when ABS is selected as time base.
MTC	Lights up when MTC is selected as time base.
REMAIN	Lights up to indicate available recording time and space on the disk.
SETUP	Lights up when the VR800 enters SETUP mode.
COMPLETED !	Lights up when an edit operation (copy, move, paste, or erase) is completed.
SURE ?	Lights up to confirm or cancel the operation when you are making settings or edits.
MTC OFFSET	Lights up when the MTC Offset menu is selected in SETUP mode.
PGM	Lights up to indicate the current program number.
TEMPO	Lights up when the tempo setting menu is selected in SETUP mode.
VARI PITCH	Lights up when vari pitch mode is turned on.
44.1kHz	The VR800 displays the sampling frequency. If the sampling frequency of the program is different from the setting for the incoming signal, the indicator flashes. If the sampling frequency of the incoming S/P DIF digital signal is different from the setting, both [DIGITAL] and [44.1kHz] flash.
MTC IN	Lights up to indicate that MTC is input from an external MIDI device to the VR800.
LOC	Lights up when the VR800 enters locate point (edit point) edit mode.

DIGITAL	When you set a digital input track in SETUP mode and the correct digital signal is input, the indicator lights up. If the signal is incorrect or the connection is faulty, the indicator flashes. It also flashes if no external digital devices are connected to the VR800.
SLAVE	Flashes when slave mode in SETUP mode is turned on. When a signal is locked, the flashing indicator lights up steadily.
MIDI	Lights up when the VR800 is receiving effective MIDI messages (MMC or FEX) from an external device.
MTC	Lights up when the VR800 receives MTC (MIDI Time Code) from an external device.
%	Lights up when the VR800 enters vari pitch data edit mode.
MB	Indicates available disk space on the disk in megabytes when the REMAIN indicator appears.
H, M, S, F, SF	Lights up to indicate a time value when ABS or MTC is used as time base.
BAR, ↓, CLK	Lights up to indicate a bar/beat/clock value when BAR/BEAT/CLK is selected as time base.
■■■■■	Indicates a program title, edit parameters, and SETUP mode parameters.
SYNC OUT	Indicates the "SYNC OUT settings" in SETUP mode.
AUTO	Indicates the AUTO PLAY/AUTO RTN mode settings.
DRIVE	The current drive that the VR800 recognizes (SCSI or ID) appears on the display. (See the following note.)
A.PUNCH	Indicates the AUTO PUNCH mode settings.
●	The indicator lights up when the digital-in clock is set to [ASYNc] (asynchronous). It turns off when the digital-in clock is set to [SYnc] (synchronous). The default setting is [ASYNc] (indicator on).

Note: If only a SCSI drive is connected to the VR800, [SCSI] lights up. If an 3.5-inch internal E-IDE hard disk has been installed but no external SCSI device is connected as the current drive, [IDE] lights up. If a SCSI drive is connected, turned on, and specified as the current drive, and an internal hard disk is also connected, only [SCSI] will light up.

Display examples for time base selected via the TIME BASE SEL key

You can use the TIME BASE SEL key to select ABS, BAR/BEAT/CLK, or MTC as time base. The following examples show the displays when you select a time base at the beginning of the disk of program 1.

Time base is ABS.

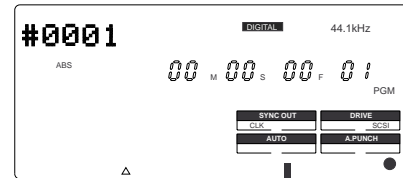

Time base is BAR/BEAT/CLK.

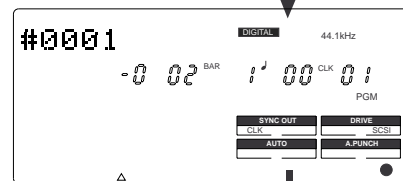

Time base is MTC.

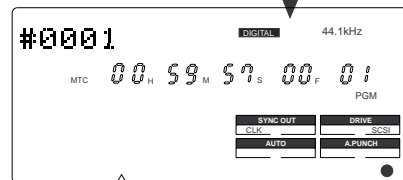

Selecting time base using the DISP SEL key

When you press the DISP SEL key after you select a time base using the TIME BASE SEL key, the display changes as follows:

Time base is ABS.

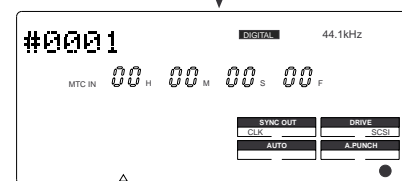
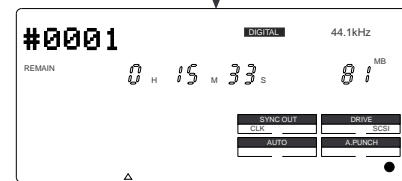
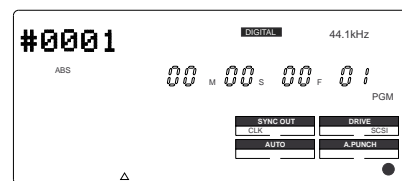

Time base is BAR/BEAT/CLK.

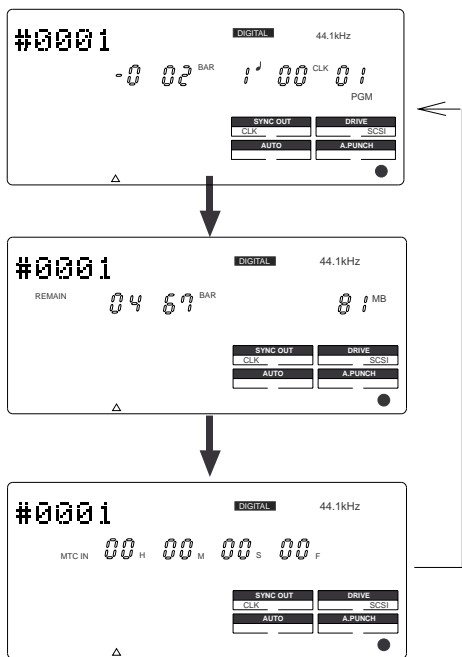

Time base is MTC.

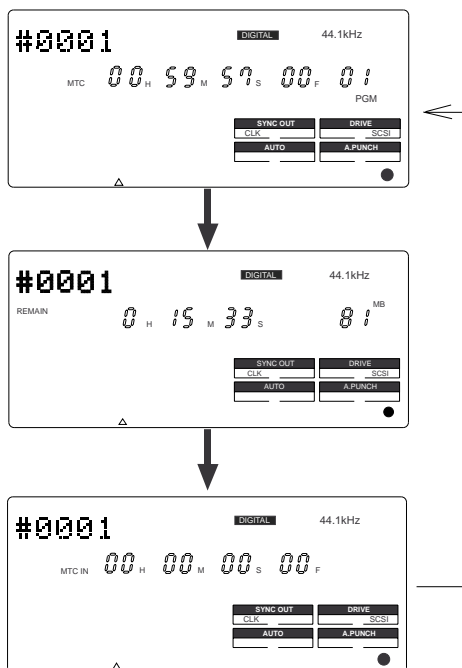

The REMAIN display

The REMAIN display usually shows available recording space and time on the disk, calculated based on mono track recording. That is, it indicates how much space and time are available for recording on a track. Therefore, if you wish to know how much time is available for multiple-track recording, you need to divide the REMAIN value by the number of tracks you wish to record. The value calculation includes all data from real tracks and additional tracks. If some data exists on the additional tracks, but not on the real tracks, the space and time consumed by the additional tracks are considered during the calculation. For more information on the REMAIN display, please refer to "Recording method and REMAIN display" in the "Before Starting" chapter on page 21.

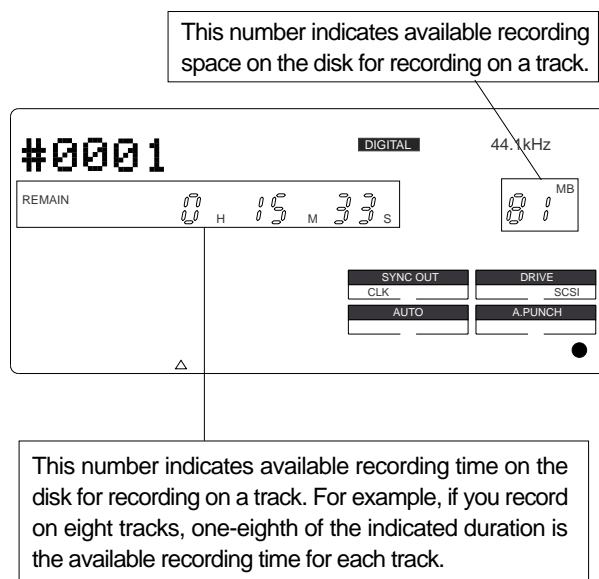

Warning messages

The following warnings are shown operating mistakes are made, an unsuitable editing point (= locate point) is input, or when errors occur. If any of these warnings appear, refer to information detailed below.

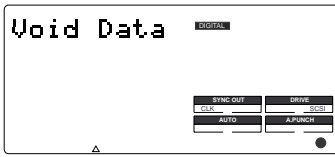

<Void Data> message

This means registered data necessary for the selected operation is incorrect.

Action to take: Re-register the correct data.



<Void Out !> message

This means the registered in/out point is wrong.

Action to take: Re-register the correct data.

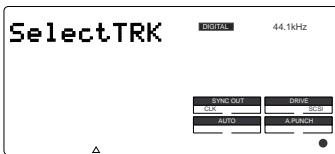

<Select Trk> message

This means a track has not been specified.

Action to take: Select any one track with the RECORD TRACK select key.

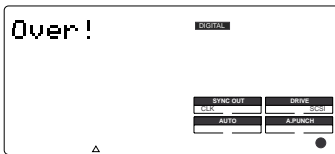

<Over !> message

This means there is insufficient disk space necessary for recording and editing.

Action to take: Before proceeding to the next operation, temporarily data in order to source empty space necessary for the next operation.

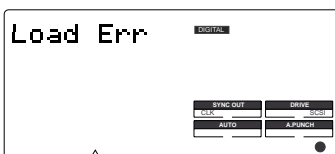

<Load Err > message

This means that loading is impossible because there is an error in data applied to the DATA IN connector from the external DAT, or adat.

Action to take: Check the external DAT or adat connected to the DATA IN connector and be sure there is no problem with the DAT, or adat tape. Then, try loading again.



<Unformat !> message

An unformatted or crashed SCSI disk. After a few seconds of this display, the VR800 automatically enters the SETUP mode [Format ?] menu.

Action to take: Press the EXECUTE/YES key while pressing the RECORD button.

Note: Any sound data recorded up to this point on the disk will be lost.



<Track Over> message

This message appears when trying to record more than 2 tracks of signals simultaneously using a MO drive/disk as a Current Drive.

Action to take: The MO drive only allows to record up to 2 tracks at a time. After changing the RECORD TRACK select key setting, please record signals.

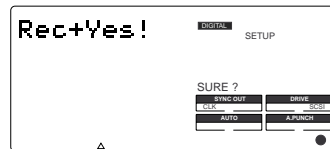

<Rec + Yes !> message

This is displayed when formatting. This means press the EXECUTE/YES key while pressing the RECORD button.

Action to take: Press the EXECUTE/YES key while pressing the RECORD button.



<Protected> message

This means the disk inserted in the drive cannot be used because it is write-protected. The disk will be ejected automatically.

Action to take: Release the write-protect and re-insert it.

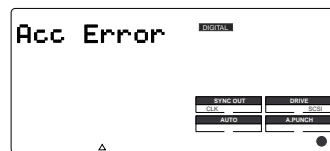

<Acc Error> message

This message indicates that an error occurs when accessing the disk. With this message, no keys and buttons do not function at all.

Action to take: If this message appears, please use the following procedures.

1. Leave the disk inside the SCSI drive and turn off the power to the VR800 and all connected devices.
2. Turn on the power to the SCSI drive.
3. Make sure that the orange LED on the SCSI drive lights up in green and that the disk is not being accessed. Then, turn on the power to the VR800.

Before Starting

This chapter describes some basic items that you need to know before you start operating the VR800. All users, including those who are familiar with using tape-based multitrackers and those who are new to multitrackers, should read this chapter thoroughly to understand the functions of the VR800.

1. Time Base
2. Recording method and REMAIN indicator
3. Managing songs by Program Change function
4. Real tracks and Additional tracks
5. Input monitoring and playback monitoring
6. Audio file and Event

Time Base

The word “Time Base” appears frequently in this manual. The concept of Time Base is similar to a “tape counter” on a conventional tape-based multitracker in that it indicates the precise position of the recorder transport section (the current position).

The VR800 offers three types of Time Base: ABS (Absolute type), MTC (MIDI time code), and BAR/BEAT/CLK (bar/beat/clock). ABS indicates an absolute time on the disk. MTC indicates a relative time that is obtained by adding a certain value (MTC offset value) to the ABS value. BAR/BEAT/CLK indicates the position in a song created in the internal Tempo Map according to MIDI clock and Song Position Pointer. The following diagrams depict the relationship among these three types of the Time Base.

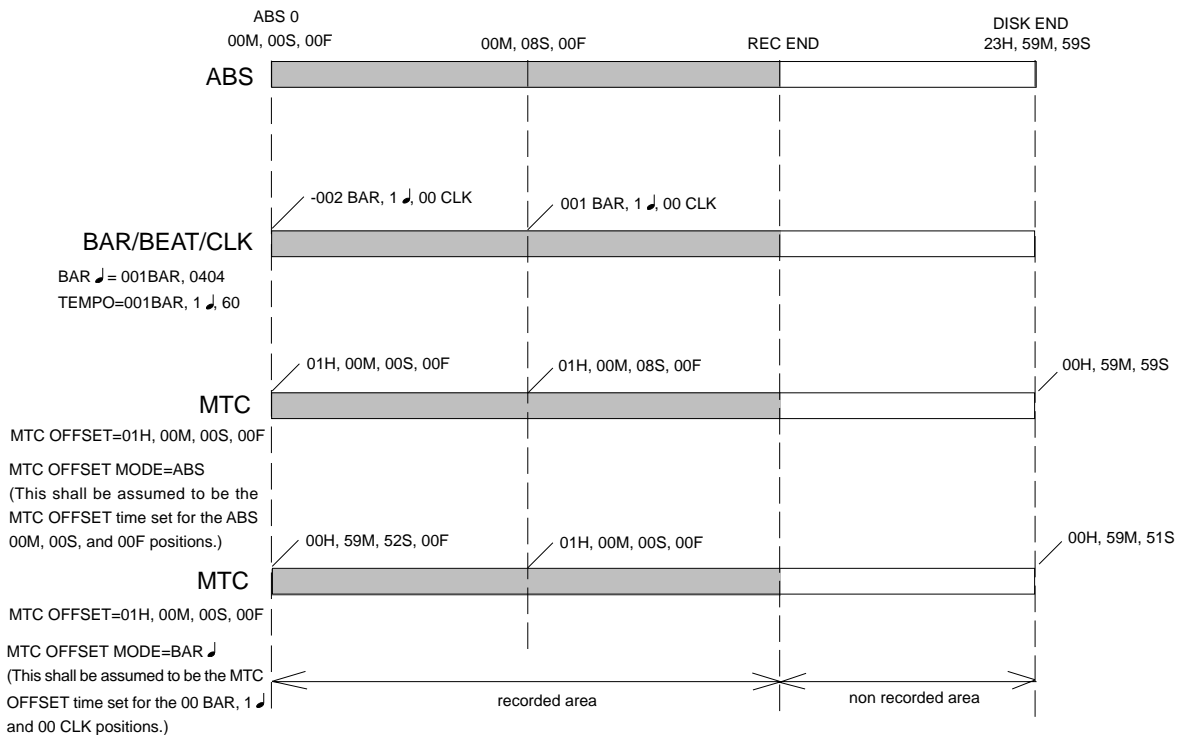

You can switch between these three types of Time Base to suit your purpose. (Refer to the explanation in “Display Section” on page “17” for more information on switching Time Base.)



Note: As shown in the figure, the ABS 0 position (top of the disk) is [-2BAR, 1BEAT, 00CLK] (Time Base - BAR/BEAT/CLK). You can change this position in the range of -9 BAR to -2 BAR in the “Setting the time signature” menu. Refer to the “Setting the time signature menu” section on page 91.

Recording method and REMAIN indicator

Recording method

The VR800 uses a E-IDE hard disk, SCSI removable disk (such as an MO disk, zip disk etc.), or fixed disk instead of a cassette tape. You can start recording sound sources from any point on a formatted disk as long as the point is within the range of 24 hours in ABS time, as described in the previous "Time Base" section. (Refer to the following diagram.)

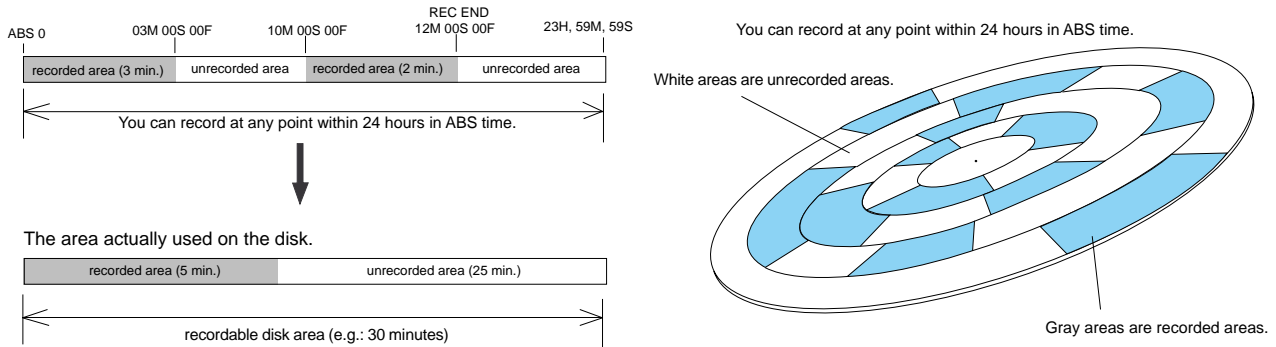

For example, if you record three minutes of data starting from ABS 0 (top of the disk) to ABS 03m 00s 00f on a disk that has a recordable space of thirty minutes, as shown in the diagram, then if you record two minutes starting at the 10-minute point in ABS time (ABS 10m 00s 00f) to ABS 12m 00s 00f, the recording end point (REC END) is 12 minutes (ABS 12m 00s 00f) in ABS time. However, this does not mean that the entire recording duration is 12 minutes. The disk space actually used for recording is five minutes (3 minutes + 2 minutes).

That is, the area between three minutes and ten minutes (that corresponds to 25 minutes of recording space) in terms of ABS time is still unrecorded.

When you try to play or fast forward this unrecorded area, the time counter on the display will count, but the VR800 will not access the disk. However, MTC will be output when you try to play this area.

On the VR800, the top of the disk is called "ABS 0" and the recording end point is called "REC END."

REMAIN indicator

The REMAIN indicator displays available recording time expressed in time value (ABS or MTC) or bar/beat/clock (BAR/BEAT/CLI) value, depending on the currently selected Time Base. It also indicates the available disk space. Right after you format the disk, the REMAIN indicator will show the maximum recordable time and space on the disk. The following example shows that the disk had about 20 minutes or 100MB recordable space after the disk format operation, and has recorded data of 4 minutes 27 seconds (or 19MB).

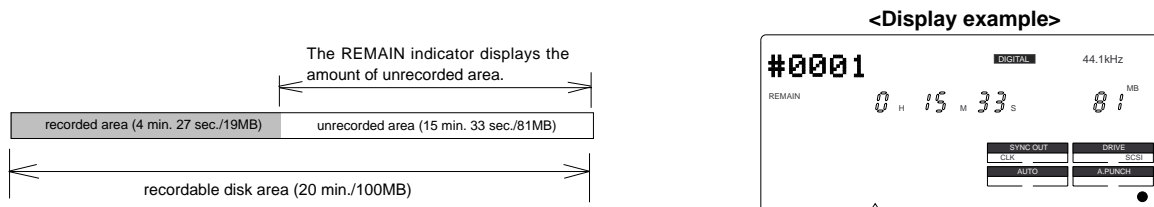

The REMAIN value is calculated on a mono-track basis. That is, the value indicates available recording time and space if you record on one mono track.

For example, if you wish to know how much you can record on four tracks, you need to divide the current REMAIN value by eight.

The REMAIN value is also calculated by deducting the time and space of all data on the Real tracks and Additional tracks from the original available recording time and space. Therefore, even if there is no recording on Real tracks, but there is data on Additional tracks, the REMAIN time will consider the time and space used by the data to calculate available time and space.

As described in "Managing the song by Program," the VR800 can set up as many as 99 Programs on the disk. Setting up a Program requires a small amount of disk space. In other words, disk space is used not only for storing recorded data but also for storing all setup data. Therefore, make sure that you have enough space on the disk before you start recording to avoid running out of space (the [OVER !] message flashes in that case).

Managing songs by Program Change function

The VR800 features Program Select function, which enables you to set up to 99 Programs on the disk. When you format a disk, one Program will be automatically created on the disk. You may create more Programs, if necessary. You may also delete unnecessary Programs.

The VR800 also features Program Change function that enables you to select one of the Programs set on the disk. Programs on the disk are something like independent containers. You can record, play, and edit each container without affecting other containers. You can also name Programs, which is useful for managing songs.

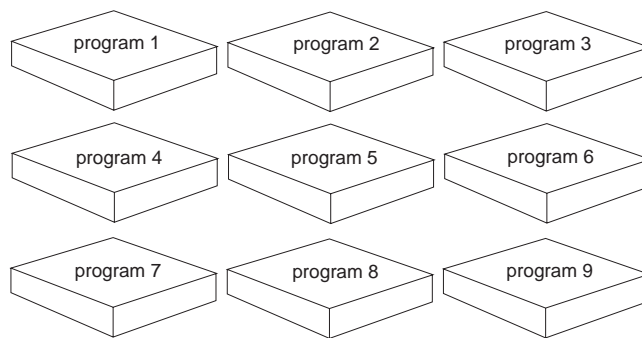

You can set up to 99 programs (independent containers).

You can name a program.
This example shows a "temporary title" automatically named to program 1 right after you format the disk.

This indicates the number of the currently selected program.
In this example, Program 1 selected.

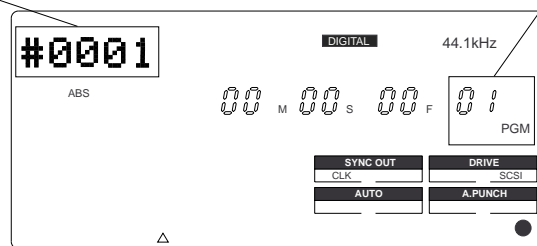

Refer to page "33" for more information on the program select function.



Refer to page "34" for more information on the program delete function.



Refer to page "35" for more information on the editing a program title.



Note: Total available recording time is always the maximum available recording time on the disk, regardless of the number of Programs you set on the disk. That is, if you use up the maximum recording time for one Program, you will not be able to record any data in other Programs.



Note: As described in the "REMAIN indicator," creating additional Programs will consume a small amount of disk space.

Real tracks and Additional tracks

The VR800 features eight Real tracks (1-8) and sixteen Additional tracks (9-24), for a total of twenty-four tracks. Real tracks are used to record sound sources in real-time. Additional tracks are used to temporarily store the sound recorded in the Real tracks. This is useful since you can move data from Real tracks to Additional tracks to clear tracks for fresh recording. The Track Exchange function of the VR800 handles this operation. This function allows you to swap data freely between twenty-four mono tracks. You can also swap data between multiple Real tracks and Additional tracks as an eight-track unit.

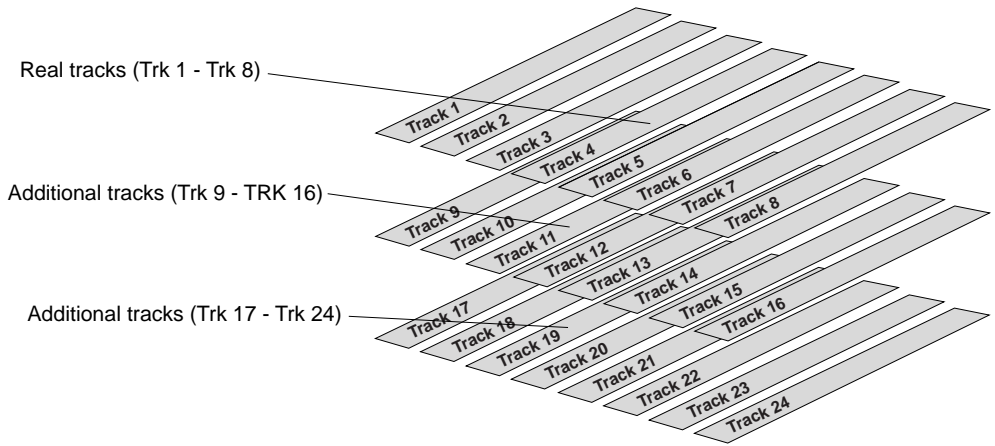

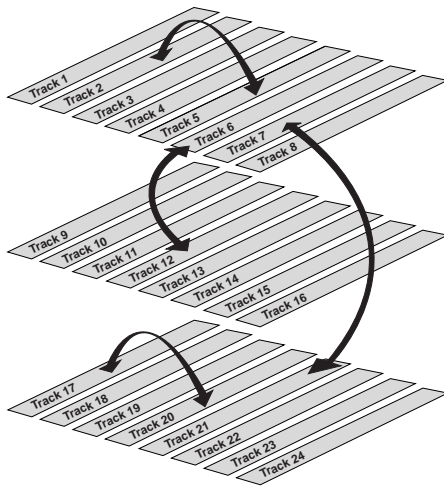

You can swap data between twenty-four mono tracks.



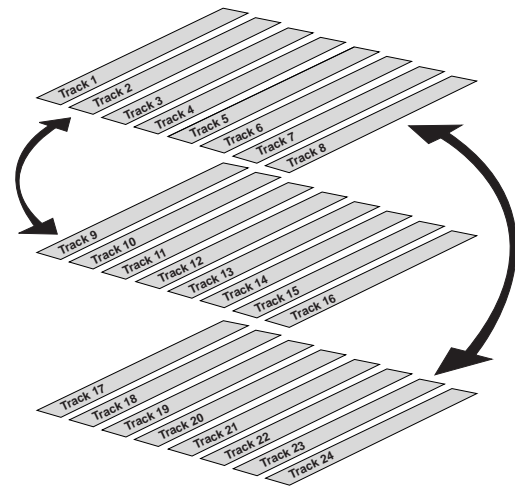

You can also swap data between Real tracks and Additional tracks in units of eight tracks.



 **Note:** Data on the Additional tracks also affects the REMAIN value. If Real tracks contain no data, but Additional tracks contain data, the amount of data (time and space) will be reflected in the REMAIN value.

 **Note:** You cannot record data on Additional tracks in real-time. Also, you cannot play back data on Additional tracks as is in real-time. If you wish to play back data on an Additional track, first use the Track Exchange function to move the data to a Real track. Also, you need to move the data to a Real track if you wish to check the REC END point of a song on an Additional track.

 **Note:** If the record time of the data existing on the additional track is longer than the data on the real track and all tracks are saved on an external DAT or adat, then the data of the additional track can only be saved for the time equal to the real track, and the remaining data is not saved. This is because the ABS 0 to REC END of the real track is automatically recognized and saved. There is a need to exchange the track using the track exchange function in this case, as well.

 Refer to page "66" for more information on the Track Exchange function.

Input monitoring and playback monitoring

There are two methods for monitoring track sound (only on the Real tracks): input monitoring and playback monitoring. They are defined as follows:

Input monitoring

Input monitoring means to monitor via track output the recording signal sent to the Real tracks of the recorder. That is, you are monitoring a post-recorder signal, not a pre-recorder signal. The VR800 enters input monitoring status when you perform one of the following operations.

• **When you set a track to recording mode**

To set a track to recording mode, press the RECORD TRACK select key to set the track READY, then press the PLAY button while holding down the RECORD button.

When recording starts on the READY track, the VR800 automatically enters input monitoring status.

• **When you set a track to recording stand-by mode**

To set a track to recording stand-by mode, press the RECORD TRACK select key to set the track READY, then press only the RECORD button. (Pressing the RECORD button again will cause the VR800 to enter playback monitoring mode.)

Under this condition, only the READY track enters input monitoring mode, on stand-by for recording.

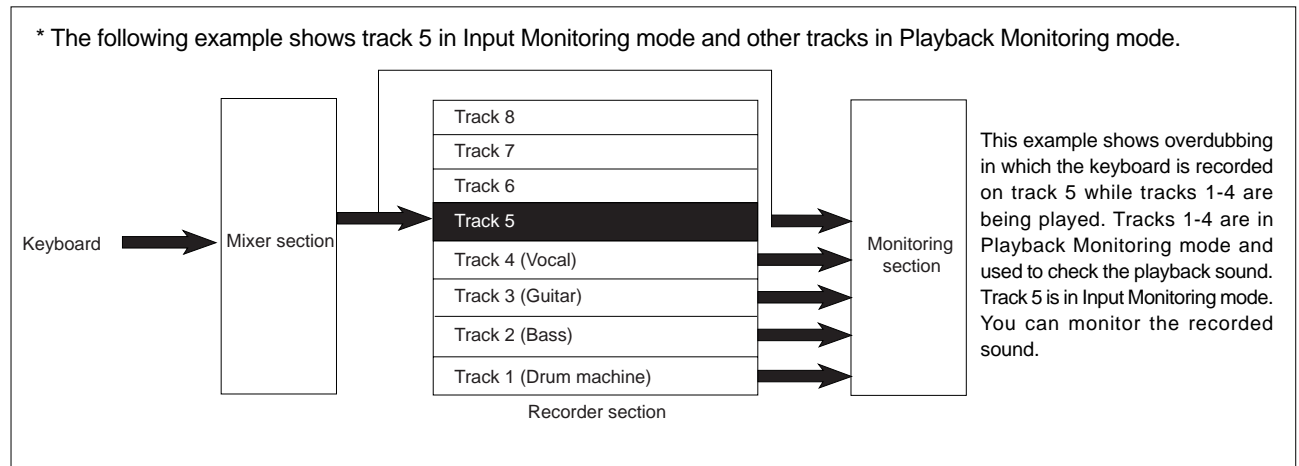

Playback monitoring

“Playback monitoring” means to monitor the playback sound of the tracks (only Real tracks).

That is, you are monitoring the playback sound on the track, not the sound being recorded to the track.

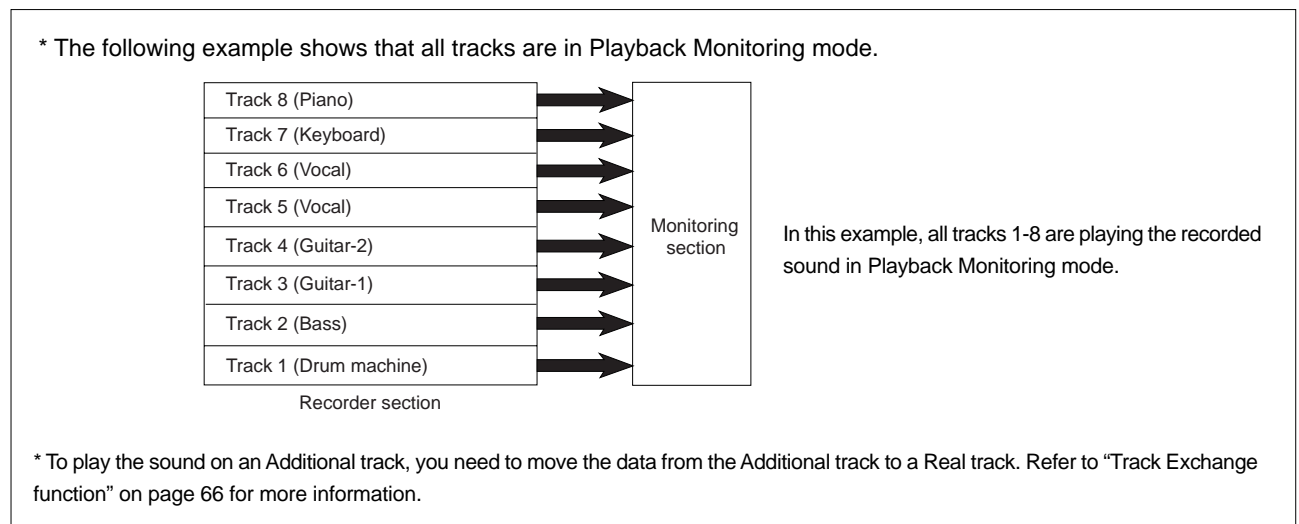

Audio file and event

<About an audio file>

During recording, the VR800 consecutively records an independent audio file (recorded area) in each track of each Program. However, you can record data on the VR800 at any point within 24 hours of ABS time, and you can intentionally create silence between two audio files. In this case, a silent part is counted as a 0 file.

Therefore, audio files and 0 files are consecutively created as shown in the diagram below.

The total number of these audio files and 0 files is called "the number of events." The maximum number of events is 512 per track (tracks 1-24). After the number of events reaches 507, new data will not be recorded.

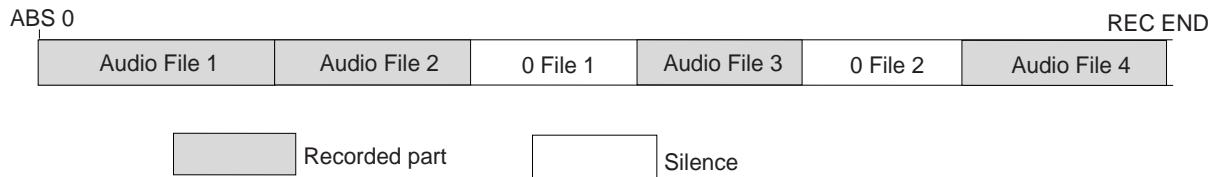

Usually, an event is created by one recording or edit. The number of events increases or decreases depending on the number of edit points or the amount of disk free space. (VR800 disk management operates in such way that the number of events will decrease.) The number of events does not affect usual music production. However, if a small amount of single-track data is written in many different sections on the disk, the maximum number of events may be reached. To avoid this "event number overflow," you need to check the number of events for each track. The VR800 provides an event check menu in Setup mode for this purpose.

<Notes on digital recording>

During S/P DIF and adat digital recording, the VR800 records "data 0" (this is called "mute recording"). When one second of consecutive data 0 is input to the VR800, it creates a "0 file" and limits the consumption of disk space. However, repeating this operation will eventually increase the number of events, leading to "event number overflow."

What is an event?

As shown in the diagram below, the number of events can be eleven or more if partial recordings are made. This is because an unrecorded part is regarded as an event, and a recorded part is also regarded as an event(s). The duration of each event can vary from 740 msec to 23 hours 59 minutes 59 seconds (FS = 44.1kHz).

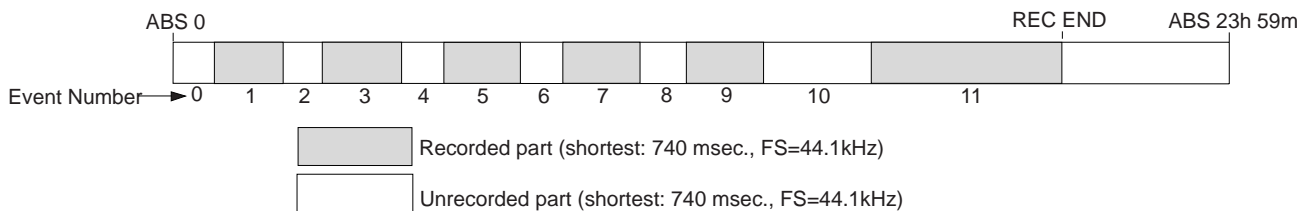

An unrecorded part (zero file) is always regarded as one even, regardless of its duration.

However, a recorded part can consist of a group of multiple audio file, as shown in the diagram below. More precisely, one audio file will be divided into multiple audio files if perform many editing operations (such as , copy & paste, move & paste, etc.) on this audio file. Multiple audio files created in this way are regarded as events. (If you do not edit the data at all, the audio file remains in one piece and is regarded as one event.)

In this example, one recorded area consists of six consecutive audio files. This means that this part consists of six events.

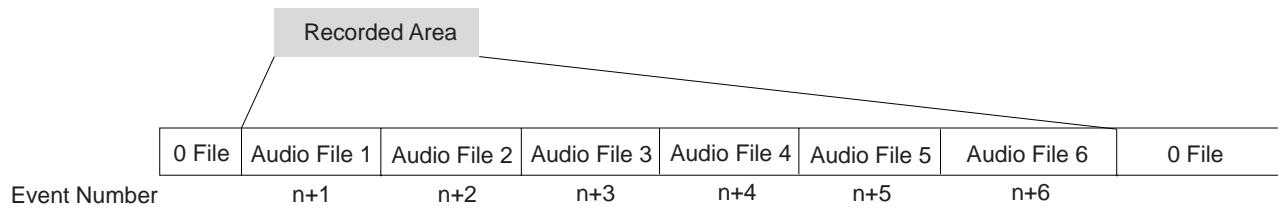

This is because when you perform a copy & paste, move & paste, or Auto Punch In/Out, the event is split at the edit point. Also, if a continuous long recording is made, the recorded data might scatter to different locations on the hard disk, thus dividing the data unto multiple events.

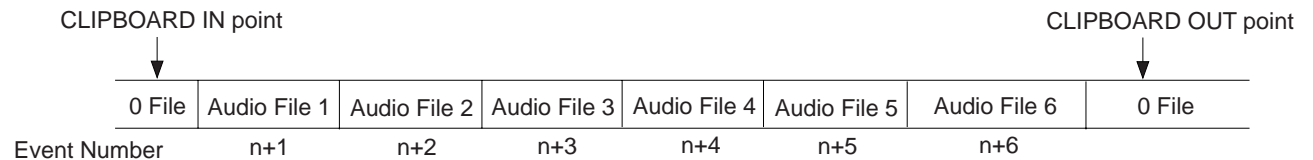

Countermeasures against accumulating too many events due to a long recording plus many editing operations:

One solution is to save and re-load the data to and from a DAT, adat, or SCSI device. (If the song is too long, you may not be able to save the data to a DAT or adat.)

In this way, multiple consecutive audio files are optimized into one continuous audio file in some cases. Set the Clipboard In point and the Clipboard Out points within an unrecorded range to copy the area (the area that contains multiple audio files and you wish to optimize) between them, then paste the data starting from the same Clipboard In point. Multiple audio files within this range will become a single audio file.

<Hints>

Make sure that you set the Clipboard In/Out points within zero files, and that you paste the area starting from the same Clipboard In point.

* In any case, bear in mind that you cannot reduce the excessive number of events if the target range contains a zero file.

Formatting a Disk

The “Quick Operation Guide” and the “Saving and Loading Song Data” chapter of this book describe how to format a disk. This chapter explains how to format an unformatted disk and how to re-format a formatted disk. Formatting a disk refers to both formatting the current drive disk and formatting a backup disk. You will use the [Format ?] and the [Bk Format?] menus in Setup Mode.

Recording mode

There are four recording Modes: “Master 8ch” mode, “Master 4ch” mode, “ADAC 8ch” mode, and “Backup” mode. Master 8ch mode, Master 4ch mode and ADAC 8ch mode are used to format a disk as the current drive disk. Backup mode is used to format a SCSI disk (removable or fixed) for saving and loading song data.

For use	Recording mode for current drive			Recording mode for backup
Record mode	ADAC 8ch mode	Master 8ch mode	Master 4ch mode	Backup mode
Sampling Rate	44.1kHz	44.1kHz	44.1kHz	44.1kHz
Quantumize	A.D.A.C. (*)	16bit liner	16bit liner	
Available recording time	Approx. 67 minutes/100MB (converted to one track)	Approx. 17 minutes/100MB (converted to one track)	Approx. 17 minutes/100MB (converted to one track)	
Compatible media	MO disk, Zip cartridge, Fixed hard disk, 3.5 inch E-IDE hard disk	Fixed hard disk, 3.5 inch E-IDE hard disk	MO disk, Zip cartridge, Fixed hard disk, 3.5 inch E-IDE hard disk	MO disk, Zip cartridge, Fixed hard disk, DVD RAM disk
Record function	* Simultaneous 8 track recording by adat digital input is possible. Note: Simultaneous recording by MO disk is a maximum two tracks.	* Simultaneous 8 track recording by adat digital input is possible.	* Simultaneous 4 track recording by adat digital input is possible. (ch1~ch4) Note: Simultaneous recording by MO disk is a maximum two tracks.	This is a special backup disk format for saving and loading data. You cannot use a disk in this format for real-time recording/playback.
Save/Load function	Save/load is possible only with external SCSI drives. Save/load is not possible with DAT and adat.	Save/load is possible only with external SCSI drive, DAT or adat.	Save/load is possible only with external SCSI drive and DAT. Save/load is not possible with adat.	You can save and load data between the backup disk and a current drive disk formatted in any mode.

(*) A.D.A.C. is the next generation digital audio coding technique maximized for multitrack recording, which has been developed by joint research of Matsushita Electric Industry Corporation and Fostex Corporation.

Note: Available recording time varies depending on the disk capacity and type. For actual available time for a particular disk, please refer to the “List of the drives with guaranteed operation” in the Owner's Manual.

Note: You cannot save programs in different formats to the same back-up disk. Be aware of this when you are using a fixed disk as the back-up disk.

Note: You can format a fixed disk or a 3.5-inch E-IDE hard disk with any ID number other than “6” in [Master 8ch] mode. If you are using a removable SCSI disk as the current drive, format it in [Master 4ch] mode or [ADAC 8ch] mode. Formatting a removable SCSI disk in [Master 8ch] mode will not provide enough recordable space.

Note that data recorded on a disk formatted in [ADAC 8ch] mode cannot be saved or loaded using a DAT or adat. Only the data recorded on the [Master 8ch] mode disk can be saved or loaded to/from a DAT or adat.

Set the ID number of a SCSI drive (fixed or removable) that will be used as a back-up disk to “6.” When you use the [Format ?] menu in SETUP mode, the VR800 recognizes SCSI drives or 3.5-inch E-IDE hard disks with any ID number other than “6.” When you use the [Bk Format ?] menu, the VR800 automatically recognizes SCSI drives with the ID number “6.”

Formatting a current drive disk (SCSI disk)

The VR800 supports SCSI removable and fixed disks and 3.5-inch E-IDE hard disks as the current drive. This section explains how to format a SCSI removable (or fixed) disk. To format a SCSI disk, the [SCSI] indicator in the [DRIVE] section of the display should be lit. If a 3.5-inch E-IDE hard disk is also connected, make sure that the [SCSI] indicator is lit as shown below.



<The display when no disk is set in the current drive.>

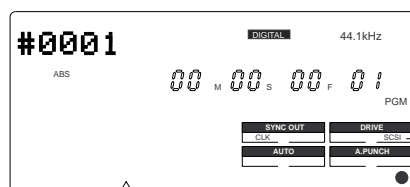

<The display when disk is set in the current drive.>

Formatting a new disk

The following procedure explains how to format a new SCSI disk, and assumes that a SCSI drive (removable or fixed hard disk) is connected to the VR800 as the current drive.

1. Turn on the power to the VR800 and the current drive.

The [Initial...] message, then [No Disk] message appears on the display. (If a fixed hard disk is connected, the [Initial...] message, then the [Un Format !] message appears and the VR800 enters SETUP mode. Skip to Step 3 below.)

2. Insert a new removable disk into the current drive.

The VR800 displays the "UnFormat!" message, then automatically enters SETUP mode, and displays the "Format ?" menu. At this time, the ID number (e.g., [ID-2]) of the connected SCSI drive (or fixed disk) will appear and [SURE ?] will blink on the display.

3. Make sure that the ID number is correct and the [SURE ?] message appears, then press the EXECUTE/YES key.

The VR800 displays [Pls Wait !], then immediately displays the recording mode menu, with [ADAC 8ch] (ADAC 8ch mode) and [SURE ?] flashing.

4. Turn the JOG dial to select the desired recording mode.

Turn the JOG dial to select [ADAC 8ch], [Master 8ch], or [Master 4ch], according to the media or your application.

Note: If you are using a removable MO or Zip disk as the current drive, select [ADAC 8ch] or [Master 4ch]. Note that you cannot save or load data via a DAT or adat if you recorded the data on a disk formatted in [ADAC 8ch] mode.

5. Press and hold the RECORD button and press the EXECUTE/YES key.

The VR800 starts formatting in selected recording mode. [REMAIN] lights up on the display, and a negative value of the unformatted disk area size will count down as the format operation progresses. Please wait a while. When formatting is complete, [COMPLETED !] lights up on the display, and the VR800 stops spinning the disk.

6. Press the EXIT/NO key or the STOP button to exit SETUP mode.

Formatting will automatically create one Program 1 on the disk. The Time Base will change to ABS 0.

7. Press the DISP SEL key to change to the REMAIN display and check the available recording time.

Press the DISP SEL key again to return to the Time Base display.

Press the EXIT/NO key while holding down the SHIFT key to eject the removable disk from the drive.

If you wish to format another removable disk, insert the disk and repeat the procedure described above.

Re-formatting a formatted disk

This section explains how to re-format a current drive or backup disk as the current disk.

You need to use the [Format ?] menu in SETUP mode to reformat a disk. In the following procedure, we assume that a SCSI drive is connected to the VR800 and that the power to the VR800 and the SCSI drive is turned on. (The same procedure also applies to a fixed disk or 3.5-inch E-IDE hard disk.)

1. Insert a formatted disk into the SCSI drive.

The VR800 displays the recording mode of the disk (ADAC 8ch, Master 8ch, or Master 4ch), then displays ABS 0 of Program 1. If you are using a disk formatted for backup, the VR800 displays [Bk Format], then the Time Base indication.

2. Press the SETUP key to enter SETUP mode and turn the JOG dial to select [Format ?].

3. Press the EXECUTE/YES key.

The ID number of the connected SCSI drive appears and [SURE ?] flashes on the display.

4. Press the EXECUTE/YES key again.

Turn the JOG dial to select [ADAC 8ch], [Master 8ch], or [Master 4ch], according to the media or your application.

5. Use the JOG dial to select the desired recording mode. Press and hold down the RECORD button and press the EXECUTE/YES key.

The VR800 starts formatting the disk in selected recording mode.

[REMAIN] lights up on the display, and the negative value of the unformatted disk area size will count down as the format operation progresses. Please wait a while.

When formatting is complete, [COMPLETED !] lights up on the display, and the VR800 stops spinning the disk.

6. Press the EXIT/NO key or the STOP button to exit SETUP mode.

Formatting will automatically create one Program 1 on the disk, and the Time Base will change to ABS 0.

7. Press the DISP SEL key to change to the REMAIN display and check the available recording time.

Press the DISP SEL key again to return to the Time Base display.

Note: Before re-formatting a formatted disk, first make sure that the disk does not contain data you want to keep. Otherwise, you may lose your important archives.

To cancel the format operation, press the EXIT/NO key or the STOP button prior to Step 5 above to return to the previous level in the menu hierarchy and exit SETUP mode.

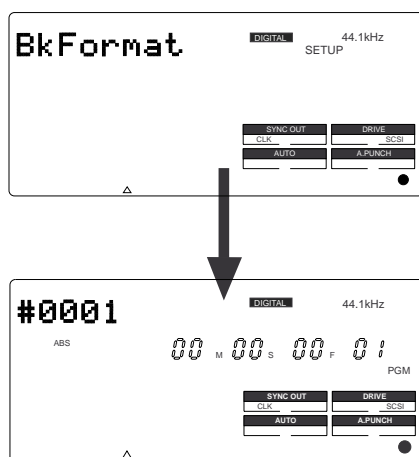

<Notes on re-formatting a disk>

When you re-format a backup disk to be a current drive disk, inserting the disk in the current drive displays [Bk Format] followed by the ABS 0 Time Base.

Although the ABS 0 Time Base appears, the disk cannot be used in its present condition as the current drive disk to perform real-time playback/recording.

Formatting a current drive disk (3.5-inch E-IDE hard disk)

When you format or re-format a 3.5-inch E-IDE hard disk, make sure that the [IDE] indicator is lit in the [DRIVE] section of the display (see the "Note" below) and follow the steps explained in the "Formatting a SCSI drive" and "Re-formatting a SCSI drive" sections.

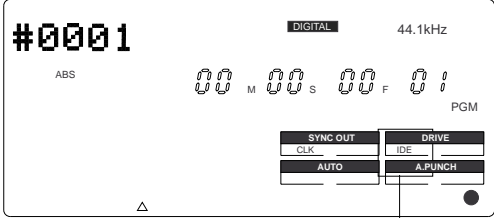

The diagram shows the VR800 display with the following elements: '#0001' at the top left, 'DIGITAL' and '44.1kHz' at the top right, 'ABS' below the first number, '00 M 00 S 00 F 0!' in the center, and 'PGM' at the bottom right. Below the display is a control panel with buttons for 'SYNC OUT', 'CLK', 'DRIVE', 'AUTO', 'IDE', and 'A.PUNCH'. The 'IDE' button is lit, and a line points to it with the text '[IDE] lights up'.

<Note on formatting a 3.5-inch E-IDE hard disk>

The [IDE] indicator appears on the display if you turn on the power to the VR800 under the following circumstances:

- when only the 3.5-inch hard disk is connected, or
- when both SCSI and E-IDE disks are connected but only the E-IDE disk is turned on.

This means that the VR800 recognizes the 3.5-inch hard disk as the current drive. Before formatting a connected 3.5-inch E-IDE hard disk, make sure that the [IDE] indicator is lit.

Formatting a backup disk (SCSI disk)

Song data you recorded in the current drive (SCSI drive, fixed disk, or 3.5-inch E-IDE hard disk) can be saved to a backup SCSI drive disk, as well as a DAT or adat, and can be re-loaded later. To use a backup SCSI drive, you need to set the SCSI ID number of the backup drive to "6" and format it in backup recording mode.

The VR800 does not indicate the connected backup disk on the display (unlike the current drive). You need to use [Bk Format?] menu in SETUP mode to format a backup disk while the current drive is on. However, if the disk has not yet been formatted, you may format it during the save/load operation.

For more information on formatting an unformatted disk for saving and loading song data, refer to "Saving and Loading Song Data" on page 75.

The following procedure assumes that a current drive (SCSI drive, fixed disk, or 3.5-inch E-IDE hard disk) is connected to the VR800, and a Program on the current drive disk is selected.

Formatting an unformatted disk for backup

This procedure enables you to format a new disk for backup, and assumes that a disk has been installed in the current drive.

1. Insert a new disk into the backup drive.

The display remains showing the Time Base indication for the current drive disk.

2. Press the SETUP key to enter SETUP mode, and turn the JOG dial to select the [Bk Format ?] menu.

3. Press the EXECUTE/YES key.

The VR800 displays [UnFormat] and [SURE?] flashes. This means that the disk with the ID number "6" is ready for formatting.

If you turn the JOG dial, [Eject] appears, and pressing the EXECUTE/YES key will eject the disk.

4. Press and hold the RECORD button and press the EXECUTE/YES key.

The VR800 starts formatting [REMAIN] lights up on the display, and the negative value of the unformatted disk area size will count down as the format operation progresses. Please wait a while.

When formatting is complete, [COMPLETED !] lights up on the display, and the VR800 stops spinning the disk. At the same time, the VR800 shows the maximum recordable space. (To check the REMAIN time and space, refer to the next page following <Memo>.)

5. Press the EXIT/NO key or the STOP button.

The display will change from the REMAIN indication for the backup disk to the Time Base indication for the current drive.

<Memo>

To check the REMAIN time for the backup disk after formatting it, eject the disk, then replace it with the disk in the current drive. Then press the DISP SEL key to show the REMAIN display. You can check the REMAIN time of the backup disk in this way. However, you cannot perform another operation using the backup disk at this time. Attempting to do so will cause the VR800 to display [Viod Cmd! (Void Command!)] and ignore your operation.

To eject the disk from the backup drive or the current drive after the format operation, follow the procedure below:

- * To eject a disk from the backup drive: **Press the Eject button on the drive.**
- * To eject a disk from the current drive: **Press and hold the SHIFT key and press the EXIT/NO key.**

Re-formatting a formatted disk for backup

This section explains how to re-format a backup or current drive disk as a backup disk. The following procedure assumes that a disk has been installed in the current drive.

1. Insert a formatted disk into the backup drive.

The display continues to show the Time Base for the current drive.

2. Press the SETUP key to enter SETUP mode, and turn the JOG dial to select the [Bk Format ?] menu.

3. Press the EXECUTE/YES key.

The VR800 displays the recording mode that corresponds to the disk format. The [SURE ?] message flashes. A different message appears depending on the type of format used by the disk as shown below. If you turn the JOG dial, [Eject] appears, and pressing the EXECUTE/YES key ejects the disk.

Type of format	Message
Backup mode	[Bk Format]
ADAC 8ch mode	[ADAC 8ch]
Master 8ch mode	[Master 8ch]
Master 4ch mode	[Master 4ch]
Others	[Un Format]

4. Press and hold the RECORD button and press the EXECUTE/YES key.

The VR800 starts formatting.

[REMAIN] lights up on the display, and the negative value of the unformatted disk area will count down as the format operation progresses. Please wait a while.

When formatting is complete, [COMPLETED !] lights up on the display, and the VR800 stops spinning the disk. At the same time, the VR800 shows the maximum recordable space. (To check the REMAIN time and space, refer to the <Memo> on the previous page.)

5. Press the EXIT/NO key or the STOP button.

The display will change from the REMAIN indication for the backup disk to the Time Base indication for the current drive.

Note: Before re-formatting a formatted disk, first make sure that the disk does not contain data that you want to keep. Otherwise, you may lose your important archives. To cancel the format operation, press the EXIT/NO key or the STOP button prior to Step 4 above to return to the previous level in the menu hierarchy and exit SETUP mode.

Formatting a backup disk (fixed disk)

You can also use a fixed disk by setting its ID number to "6."

The formatting procedure described above also applies to formatting a fixed disk as a backup disk.

Handling Programs

This chapter explains how to handle Programs. It covers the following topics:

1. Creating a new Program
2. Using a Program Change function
3. Deleting a Program
4. Editing a Program title

Creating a new Program

You can manage individual songs by setting multiple programs on the disk as explained in the “Managing songs by program change function” section of the “Before Starting” chapter. Up to 99 programs can be created as long as disk space is available. When you format a disk, one program will be automatically created. Follow the steps below to create a new program (in addition to the Program created on the disk during the format operation).

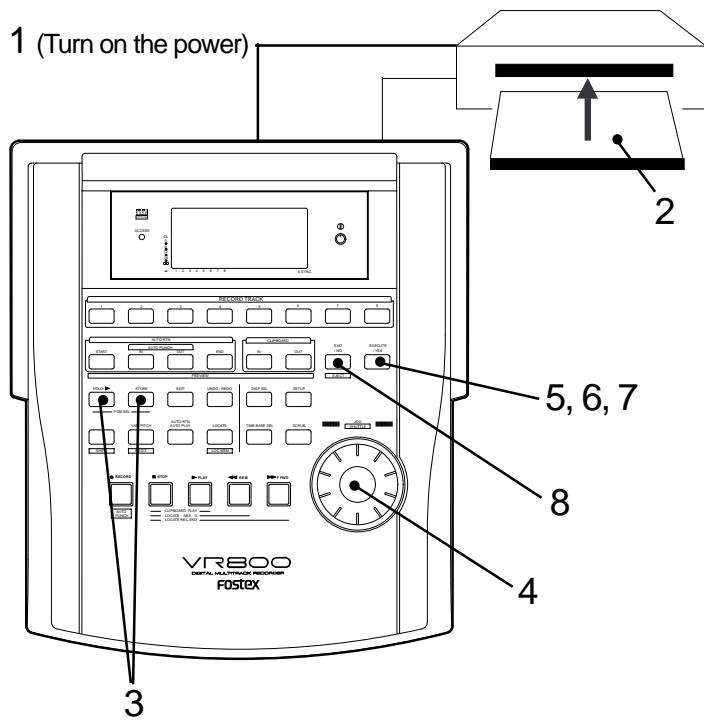

1. Turn on the power to the VR800 and a connected SCSI drive.

2. Insert a formatted disk into the SCSI drive.
 The VR800 will display [Initial.], [(SCSI drive name and ID number)], [(Recording mode, such as [ADAC 8ch])], then the top of ABS time base (ABS 0).
 The current program is [PGM 01]. [#0001] is the default name of PGM 01.

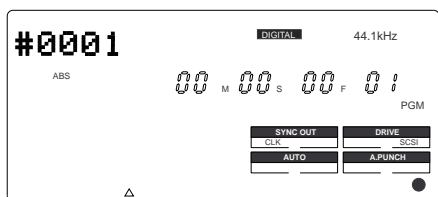

3. While holding down the HOLD/> key, press the STORE key.
 [Select PGM] appears on the display briefly, then changes to a flashing “01” ([#0001 of PGM 01] and [SURE?] flash. ([#0001] is the default name of PGM 01.)

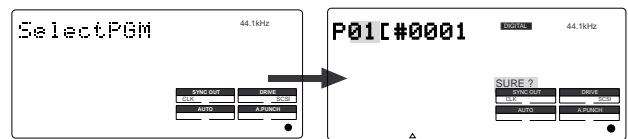

4. Turn the JOG dial clockwise.
 The question marks “?” of [New PGM ?] and [SURE?] flash. This indication asks you if you wish to set a new program (program 2).



5. Press the EXECUTE/YES key.
 The VR800 will automatically enter [Title Edit ?] menu in SETUP mode. You can enter a title for program 2. ([#] and [?]) flash alternately.)
 If you prefer the default name, press the EXIT/NO key.

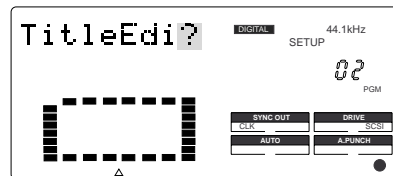

6. Press the EXECUTE/YES key again.
 A default title (#0002) appears on the display, with [#] and [SURE?] flashing. This means that you can enter a name for the new program.
 If you wish to name the program, continue the steps below. In either case, you can change the title later, as explained in “Editing a program title.”

To enter a title:

- Turning the JOG dial will enter a character or number at the location of the flashing cursor. You can enter up to 16 characters, nine of which will appear on the display.
- To move the flashing cursor, press the HOLD/> key, the REWIND button, or the F FWD button. The F FWD button is the most convenient.
- You can enter the following characters and numbers:

```

# $ % & ' ( ) * + , - . / 0 1 2 3 4
5 6 7 8 9 : ; < = > ? @ A B C D E F
G H I J K L M N O P Q R S T U V W X
Y Z [ \ ] ^ _ ` a b c d e f g h i j
k l m n o p q r s t u v w x y z { |
} ~ € _ ! "
    
```

7. When you finish entering the title, press the EXECUTE/YES key.

Program 2 (PGM 02) and its title are set. The display shows the ABS time base indication of the program.

<Important!>

- Whenever you create a new program by selecting the [New PGM ?] menu, a new program is created with an increment number. That is, if only one program exists, the next one will be named program 2. If programs 1-5 already exist, the new program number will be 6.
- If there is insufficient recording space on the disk, you cannot create the new program. Each time you create a new program, the recordable area on the disk will decrease.

Using a Program Change function

If multiple programs exist on the disk, you need to select a program to record, play, or edit. This section describes how to select a program.

Note: You cannot use the program change function if the VR800 is in SETUP mode.

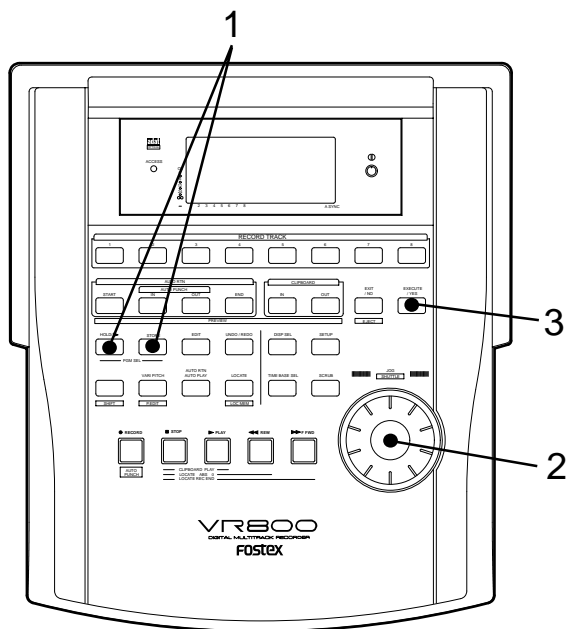

1. When the VR800 is stopped, press the STORE key while holding down the HOLD/> key.

[Select PGM] will appear on the display briefly, and then change to a flashing "01" ([#0001 of PGM 01) and [SURE?] flash. ([#0001] is the default name of PGM 01.)

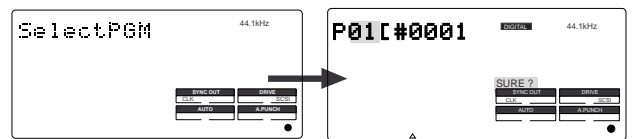

2. Turn the JOG dial to select the desired program number (flashing).

Rotating the JOG dial counter-clockwise decreases the number. Rotating it clockwise increases the number. If you turn the JOG dial clockwise all the way, [New PGM?] will be selected. Select [New PGM ?] to create a new program as mentioned in the previous section.

For example, you can select one of seven programs as follows:

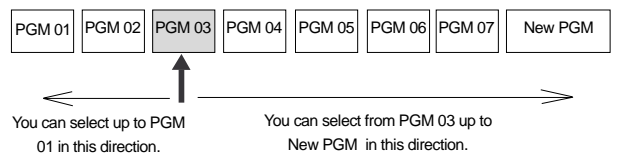

3. Press the EXECUTE/YES key.

The ABS time base indication for the selected program appears. In this way, you can be sure to select a program before you start working.

Deleting a Program

This section explains how to delete a program.

Deleting an unnecessary program will expand the recordable area, making your work flow more smoothly, since recording or editing requires free space on the disk. Use the [Del. PGM ?] menu in SETUP mode to delete a program.

<Notes on deleting a Program>

- You can delete only the currently-selected program. Refer to the previous section, "Using a program change function," for information on how to select the desired program before you proceed to delete the program.

- <IMPORTANT> If only one program exists and you try to delete it, data contained in the program will be deleted, but the program itself will remain. For example, assume that PGM 01 -07 exist and you try to delete PGM 05. Program number 05 will remain, but the data inside PGM 05 will be replaced with the data of PGM 06. The subsequent programs' data will move in the same way. Therefore, it will appear that PGM 07 has been deleted. If you delete the last program (PGM 07 in this example), PGM 07 will be completely deleted.

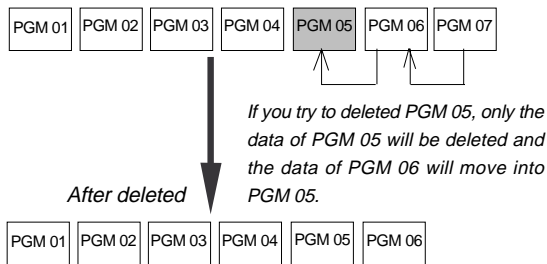

Note: You cannot use the Undo/Redo function to delete programs. Make sure that you delete the correct program.

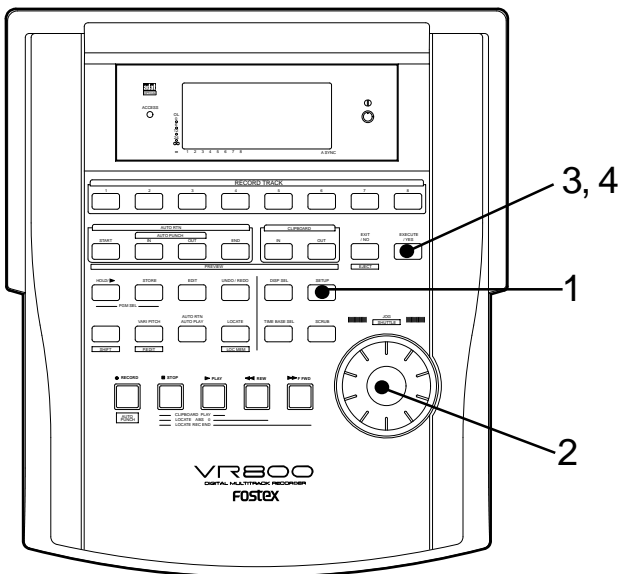

1. Press the SETUP key while the VR800 is stopped.

The VR800 will enter the SETUP mode, and display the first hierarchy of the SETUP menu that was displayed before you turned off the power.

The default setting is [Sign. Set ?] menu (setting a time signature).

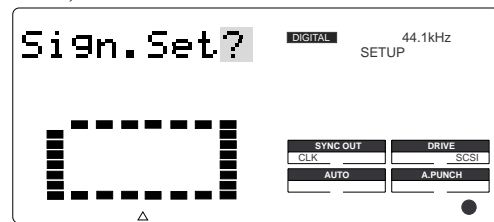

2. Turn the JOG dial to select the first hierarchy of the [Del. PGM ?] (deleting a Program) menu.

Or, you can use the HOLD/> key, the REWIND button, or the F FWD button.

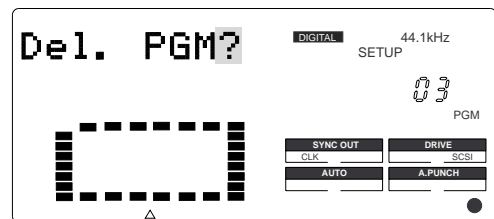

3. Press the EXECUTE/YES key.

The number of the program to be deleted appears and [SURE ?] flashes.

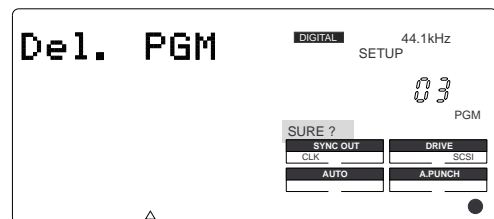

To cancel the delete operation, press the EXIT/NO key while [SURE ?] is flashing. Each time you press the button or key, the VR800 will return to a higher level in the hierarchy, and finally exit the SETUP mode.

4. Press the EXECUTE/YES key again.

When the VR800 displays [Deleting...] and finishes deleting the program, the data of the next program number moves in, and its ABS time appears.

- To check the REMAIN time and free space, press the DISP SEL key to display the [REMAIN] indication after the program is deleted.

Editing a Program title

You can name the program as explained in the "Creating a new program" section. You can also change the title later by using the [Title Edit ?] menu in SETUP mode.

Note: You can edit the title of the selected program before you select SETUP mode. You cannot select a program after the VR800 enters SETUP mode. Be sure to select the desired program using the steps explained in the "Using the program change function" section.

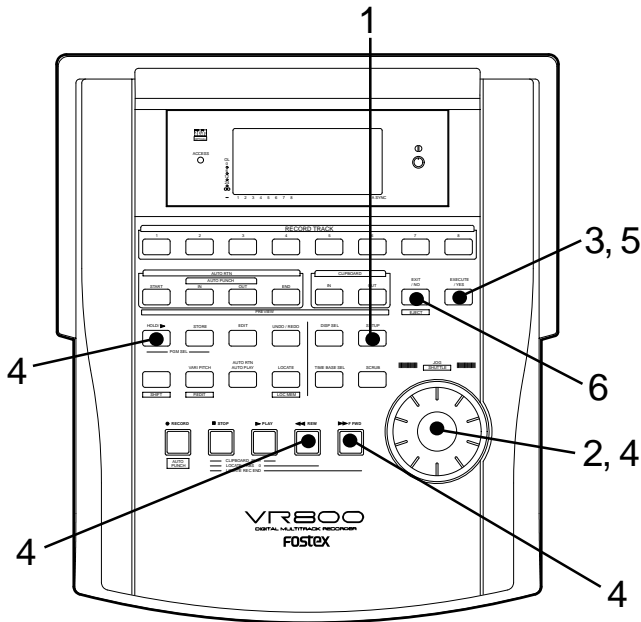

- 1. Press the SETUP key while the VR800 is stopped.**
The VR800 will enter the SETUP mode and display the first hierarchy level of the SETUP menu that was selected before you turned off the power.

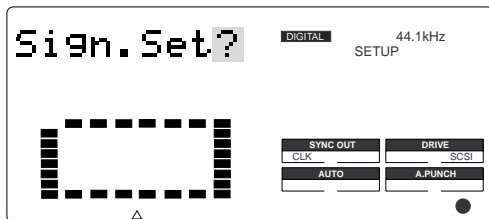

- 2. Turn the JOG dial to select the first hierarchy level of the [Title Edit ?] menu.**

The symbols [t] and [?] will flash alternately. The currently-selected program number will also appear. You can also use the HOLD/> key, the REWIND button, or the F FWD button to select the first hierarchy level display.

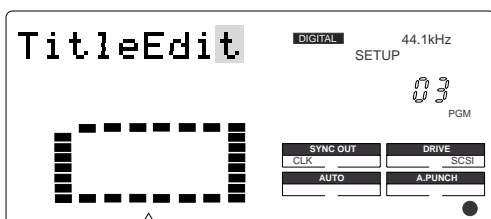

- 3. Press the EXECUTE/YES key.**

The currently-selected program title will appear with the left-most character flashing.

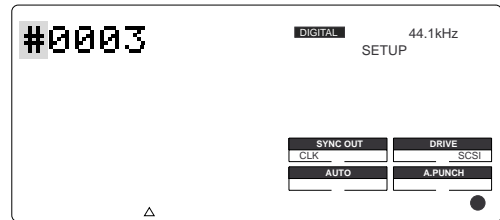

- 4. Press the HOLD/> key, the REWIND button, or the F FWD button to move the flashing cursor, and use the JOG dial to enter characters or numbers.**

To move the flashing cursor, press the HOLD/> key, the REWIND button, or the F FWD button. The F FWD button is the most convenient.

You can enter up to 16 characters, nine of which will appear on the display.

You may enter the following characters and numbers:

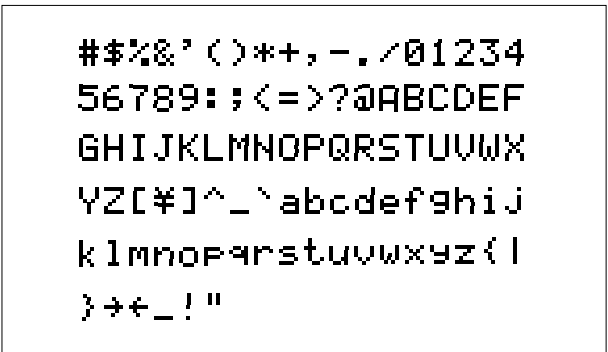

- 5. After you enter the title, press the EXECUTE/YES key.**

The new title will be confirmed, and the ABS time value of the program will appear.

Punch In/Out Recording

What is Punch In/Out recording?

Punch In/Out recording enables you to record over previously-recorded parts. See the diagram below. For example, using the Punch In/Out function allows you to change an unsatisfactory guitar solo. The VR800 offers two types of Punch In/Out functions. One is called Auto Punch In/Out, in which you automatically re-record a specified part. The other is called Manual Punch In/Out, in which you record data manually (using your foot to operate an optional foot switch, model 8051). Both functions feature “Rehearsal mode” to enable you to practice repeatedly until you are ready.

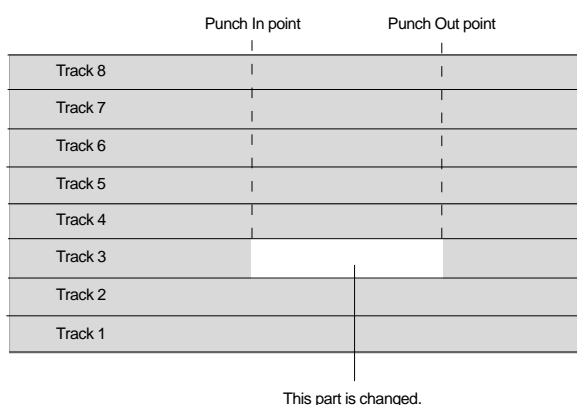

- Select a Program for Punch In/Out recording.
- Initialize the VR800.

Note: You can use the Punch In/Out recording only for Real tracks 1-8. If you wish to use Punch In/Out recording for data on an Additional track, first move the data to the Real tracks.

Auto Punch In/Out

To perform Auto Punch In/Out recording, you need to specify the Auto Punch In point (recording start point) and the Auto Punch Out point (recording end point).

Preparation

Storing the edit points

1. Refer to “Storing the edit points” to set the Auto Punch In/Out points.

Store the Auto Punch In point to the AUTO PUNCH IN key, and the Auto Punch Out point to the AUTO PUNCH OUT key.

- Refer to page “48” for more information on storing the edit points.

Note: Make sure that you specify an Auto Punch In point that precedes the Auto Punch Out point. If the Auto Punch Out point precedes the Auto Punch In point, [Void Out !] appears and you will be unable to perform Auto Punch In/Out recording.

Previewing and trimming the edit points

You can check the stored edit points by pressing the corresponding memory keys to display them on the LCD. You can also change the points if necessary. In this example, use the Preview function to fine-tune the point while previewing.

1. While the VR800 is stopped, hold down the SHIFT key and press the memory key.

Pressing the AUTO PUNCH IN key enables you to listen to the sound at the AUTO PUNCH IN point (“previewing the sound rise [fade-out]”). Pressing the AUTO PUNCH OUT key enables you to listen to the sound at the AUTO PUNCH OUT point (“previewing the sound fall [fade-in]”).

2. Trim the edit point while auditioning the sound.

- Refer to page “59” for more information on the Preview function.

When you finish storing and adjusting the respective edit points, you can proceed to the Auto Punch In/Out operations. In this example, we will re-record part of the guitar phrase on track 3, chosen from all the recordings on tracks 1-8. Prior to proceeding with this operation, check to see that an external digital mixer is connected to VR800 as shown in the figure. then confirm that the guitar to record on track 3 is connected to the input jack of the digital mixer.

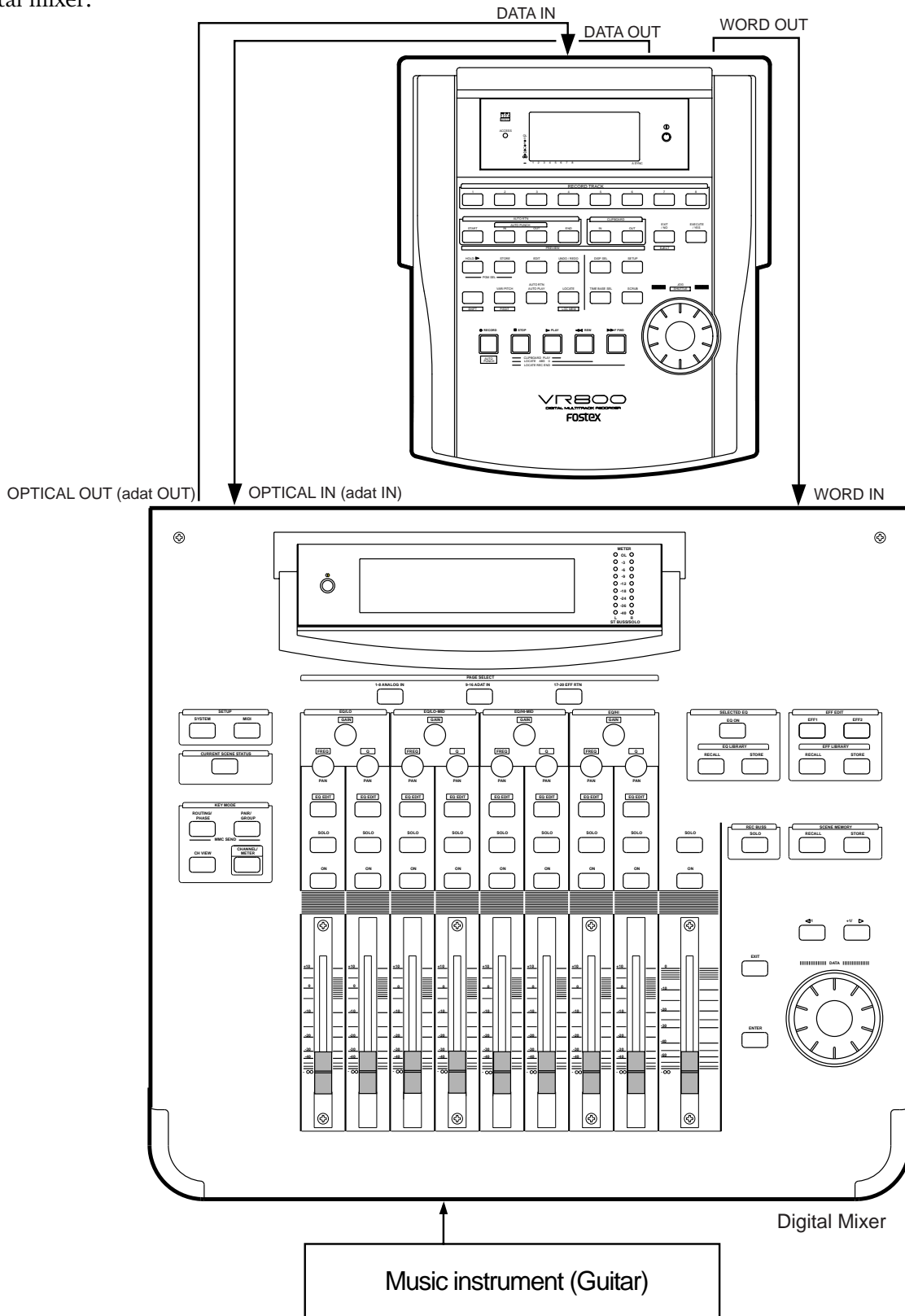

Rehearsing Auto Punch In/Out recording

In Rehearsal mode, the READY track assumes input monitoring mode between the Auto Punch In and Out points, and the sound is not recorded. You can practice Auto Punch In/Out operation repeatedly before you proceed to actual recording. Locate the recording start position slightly before the Auto Punch In point.

<Tips for rehearsal>

Set the preroll value while referring to the "Changing the Initial Settings (SETUP Mode)" chapter. In this way, the VR800 can locate a point that precedes the Auto Punch In point by the specified preroll value. This enables you to start playback slightly before the Punch In point. (Refer to page 94 for more information on "Changing the Initial Settings.") The VR800 will repeat playback data between the AUTO RTN START point and the AUTO RTN END point if you set the AUTO RTN START point before the Auto Punch In point and the AUTO RTN END point after the Auto Punch Out point. This allows you to repeat rehearsal. See the "Hint-2."

1. Press the RECORD button while holding down the SHIFT key.

The [RHSL] indicator flashes in the A.PUNCH mode indication area of the display. This means that Auto Punch mode is turned on.



2. Set the track for Auto Punch In/Out to READY.

Press the RECORD RACK select key [3] to set track 3 to READY.

3. Start playback of the VR800 from a point slightly before the Auto Punch In point.

The VR800 operates as shown in the figure below during rehearsal operations.

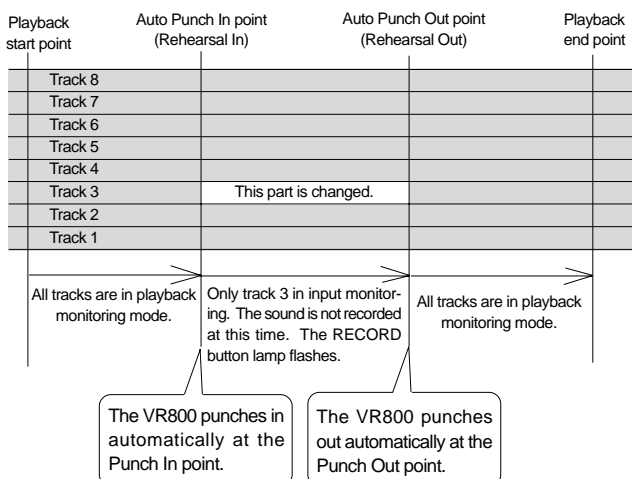

4. Play the guitar accompanying the playback sound from tracks 1 - 8 for rehearsal, while adjusting the recording level.

You will hear the guitar performance between the Auto Punch In and Out points. Otherwise, you will hear the recorded guitar sound.

5. When you are satisfied with your rehearsal, press the STOP button.

<Hint 1>

Locating a point slightly before the Auto Punch In point

To locate the playback start point for rehearsal, press the AUTO PUNCH IN key, then press the LOCATE key.

The VR800 displays the time (position) stored in the AUTO PUNCH IN key, and locates the point and stops.

Press the REWIND button to go backward. If you have set the preroll time as described on page "94," you can locate a point that precedes the Auto Punch In point by the specified preroll value.

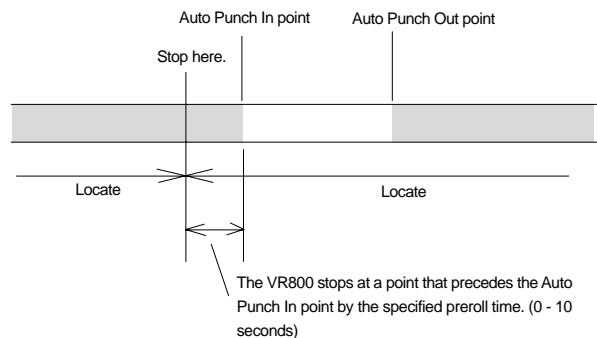

<Hint 2>

Quick and easy operation for repeated rehearsal

Using the Auto Return function and the Auto Play function enables you to rehearse repeatedly.

As shown below, set the AUTO RTN START and END points for Auto Return and Auto Play. In this way, you can repeat rehearsal easily, while checking the recording level and concentrating on your performance.

Refer to page "48" for more information on setting the AUTO RTN START/END points.

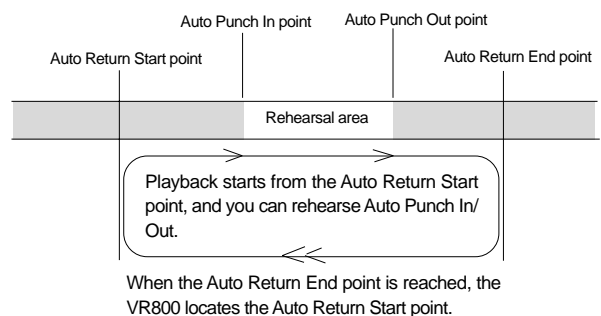

Note: If the VR800 display [Over!] when you turn on Auto Punch mode, the disk does not have enough free space for Auto Punch In/Out. You need to erase part of the Program data, then try again.

Auto Punch In/Out Take

After you are satisfied with your rehearsal, you can proceed to an actual take of Auto Punch In/Out. You can undo or redo Auto Punch In/Out recording if you change your mind. The control panel settings are the same as those for rehearsal.

1. Press the RECORD TRACK select key [3] to set track 3 to READY.

2. Locate a point slightly before the Auto Punch In point.

3. Confirm that Auto Punch mode is turned on.

Press the RECORD button while holding down the SHIFT key to turn on the function, if it is not already on.

4. Press the RECORD button while holding down the PLAY button.

The flashing [RHSL] on the display changes to an illuminated [TAKE], and recording starts.



The VR800 operates as follows.

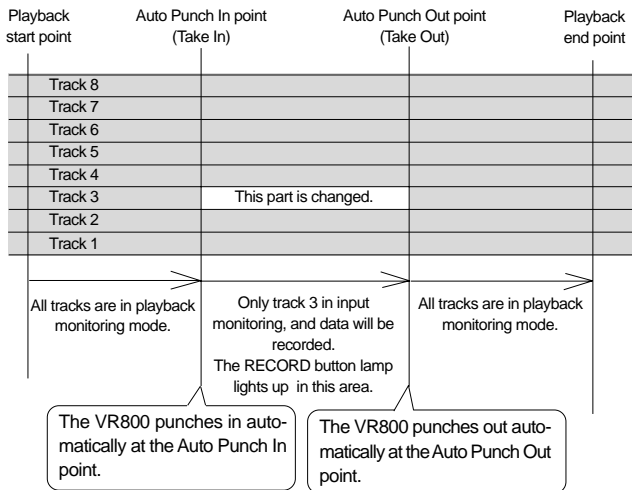

- The lamp of RECORD TRACK select key will only light up between the AUTO PUNCH IN/OUT point, and will flash in any other case.
- When the Auto Punch Out point is passed, the VR800 cancels Auto Punch mode automatically, and nothing appears in the A. PUNCH display area.

<Caution after Punch Out>

At "Take" of punch out, the punch-in recording track will not immediately enter the repro monitor mode from the input monitor mode enter the repro monitor mode about two seconds after mute playback. This is a functional feature of VR800 and not a malfunction.

5. When you finish recording, press the STOP button.

6. Play track 3 to check the result of the Auto Punch In/Out operation.

If you fail with AUTO PUNCH IN/OUT and are not satisfied, repeat the process by performing the AUTO PUNCH IN/OUT undo operations described in the next section.

Undo/Redo Auto Punch In/Out recording

You can undo or redo Auto Punch In/Out recording.

Press the UNDO/REDO key after recording is complete to restore the conditions that existed prior to the recording.

Press the UNDO/REDO key again to restore the conditions that existed after the recording.

Follow the notes below:

Note-1: The Undo/Redo function is effective only when the VR800 is stopped.

Note-2: The Undo/Redo is not effective if you perform one of the following operations after you finish recording:

- When a new recording is made.
- While a new editing is executed (such as Copy & Paste, Move & Paste, or Erase).
- When in the AUTO PUNCH ON mode, when the AUTO PUNCH IN point is passed in the PLAY (or RECORD) mode.
- When the power is momentarily switched off.
- When the program is changed.
- When ejecting a removable SCSI disk that is the current drive.

Manual Punch In/Out

This section explains how to perform Manual Punch In/Out using a foot switch (optional Model 8051). You do not need to specify the Punch In/Out points. Instead, you press the foot switch at the Punch In/Out point. Manual Punch In/Out also offers rehearsal and actual takes. You can repeat rehearsal until you are ready. As an example, replace a part of the recorded guitar solo on track 3.

- Initialize the VR800.
- Select a desired Program for Punch In/Out.

Preparation

Check to see that the guitar is connected to the input jack of the mixer, as required for [AUTO PUNCH IN/OUT] mentioned earlier.

Connect an optional foot switch (Model 8051) to the PUNCH IN/OUT jack on the side panel.

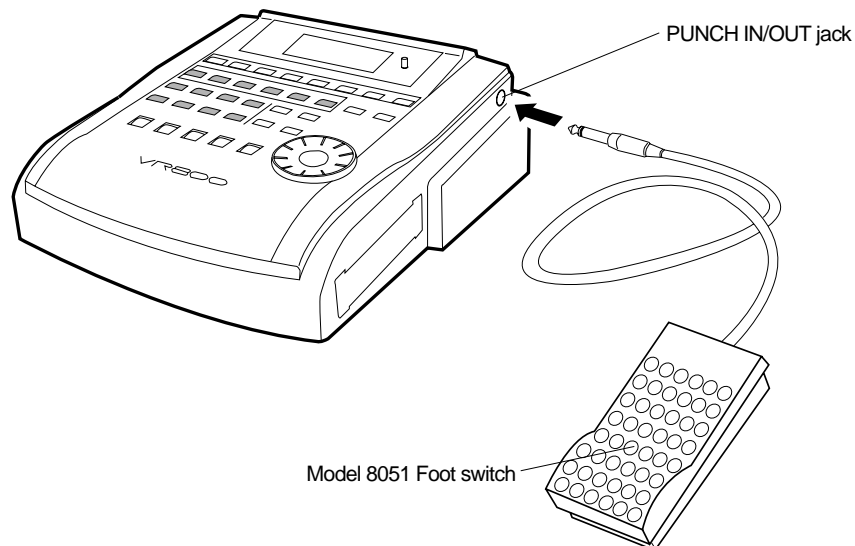

Rehearsing Manual Punch In/Out recording

In Rehearsal mode, the READY track enters input monitoring mode between the Punch In and Out points (the points at which you press the foot switch), and the sound is not recorded. You can practice the Punch In/Out operation repeatedly before you proceed to actual recording.

1. Press the foot switch while holding down the STOP button.

[Rehearsal On] will appear on the display for about 1 second, then rehearsal mode will appear and the [RHSL] flashes in the A. PUNCH display.



2. Press the RECORD TRACK select key [3] to set track 3 to READY.

3. Press the PLAY button to play back from a point slightly before the Punch In point.

4. Play the guitar accompanying the playback of tracks 1 to 8.

The recording level and monitor volume is adjusted on the mixer in the same manner as done for [AUTO PUNCH IN/OUT] described earlier.

5. Press the foot switch once at the desired Punch In point, then press the foot switch again at the desired Punch Out point.

The rehearsal mode will operate as shown in the figure. Between the Punch In and Out points the current performance of the guitar will be played as the guitar monitor sound. The previous recording is heard in any other case. The RECORD button lamp lights up when Punching In and turn off when Punching Out. (the [RHSL] remains flashing)

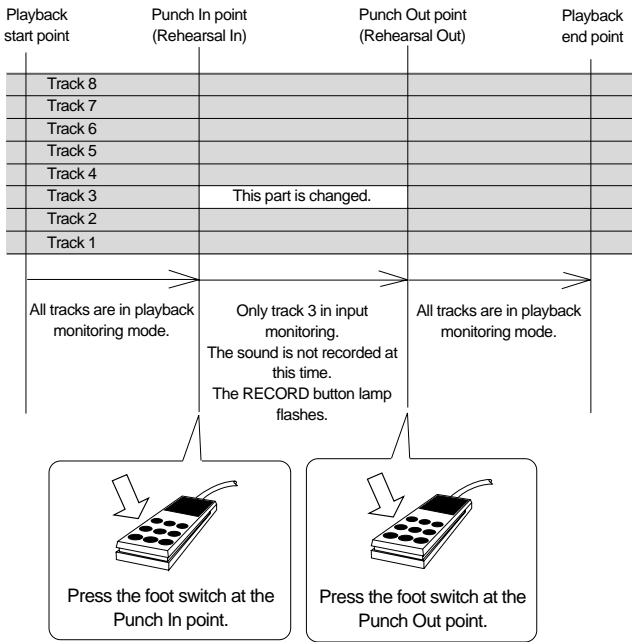

6. When you finish rehearsing, press the STOP button. If you are still unsatisfied, repeat steps 3-5.

Cancelling Rehearsal mode

1. While holding down the STOP button, press the foot switch.

[Rehsl Off] appears for a second, the flashing [RHSL] indicator in the A.PUNCH display area disappears, and Rehearsal mode is cancelled.

<Hint>

To rehearse repeatedly, set the AUTO RTN START point slightly before the Punch In point, and the AUTO RTN END point slightly before the Punch Out point.

This will help you concentrate on your performance or check the recording level easily (especially since Manual Punch In/Out involves operating the foot switch operation as well as the VR800). (See <Hint-2> in the "Rehearsing Auto Punch In/Out recording" for more information.)

Manual Punch In/Out take

You can proceed to record if you are satisfied with the recording level, foot switch timing, and rehearsal.

Note: You cannot record a second take during the Manual Punch In/Out operation without stopping the VR800. That is, the VR800 will continue playing after you finish recording a take, but you cannot record another take by pressing the foot switch.

1. Confirm that Rehearsal mode is cancelled, and start playing the VR800 from a point slightly before the desired Punch In point.
2. Play the guitar, accompanying the playback of tracks 1 to 8.
3. Press the foot switch at the desired Punch In point. Press the foot switch again at the desired Punch Out point.
The VR800 will operate as follows. The VR800 enters recording mode at the Punch In point, and cancels recording mode at the Punch Out point.
4. Press the STOP button.
5. Play track 3 and check the result of Punch In/Out.

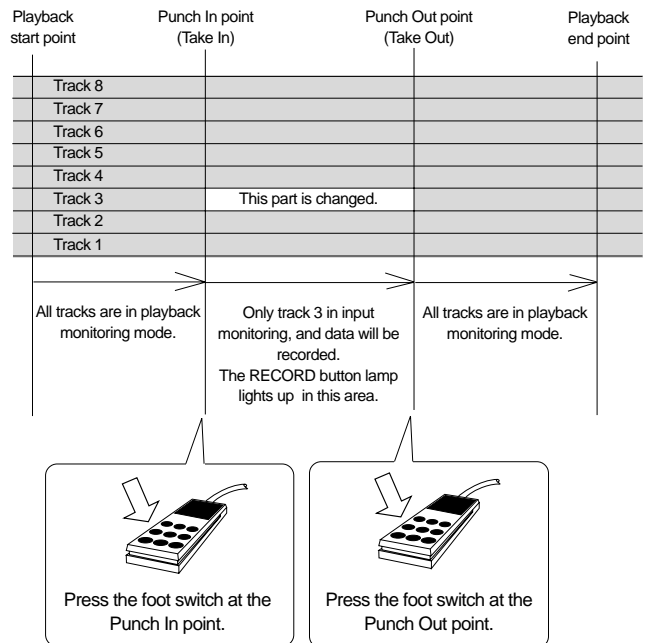

<Caution after Punch Out>

At "Take" of punch out, the punch-in recording track will not immediately enter the repro monitor mode from the input monitor mode enter the repro monitor mode about two seconds after mute playback. This is a functional feature of VR800 and not a malfunction.

<Hint>

You can use the PLAY button and the RECORD button, instead of using the foot switch. Follow the steps below.

This method also does not allow you to record another take unless you stop the VR800 first.

Procedure:

1. Press the PLAY button to start playback from a point slightly before the Punch In point.
 2. Press the RECORD button while holding down the PLAY button at the desired Punch In point. (Punch In recording starts.)
 3. Press the PLAY button at the desired Punch Out point. (Recording is punched out.)
- If you press only the RECORD button in both steps 2 and 3, you can rehearse Punch In/Out.

Undo/Redo Manual Punch In/Out recording

You can undo or redo Manual Punch In/Out recording.

Press the UNDO/REDO key after recording is complete to restore the conditions that existed prior to the recording.

Press the UNDO/REDO key again to restore the conditions that existed after the recording. Follow the notes below:

Note-1: The Undo/Redo function is effective only when the VR800 is stopped.

Note-2: The Undo/Redo is ineffective if you perform one of the following operations after you finish recording.

- When a new recording is made.
- While a new editing is executed (such as Copy & Paste, Move & Paste, or Erase).
- When in the AUTO PUNCH ON mode, when the AUTO PUNCH IN point is passed in the PLAY (or RECORD) mode.
- When the power is momentarily switched off.
- When the program is changed.
- When ejecting a removable SCSI disk that is the current drive.

Recording to a Metronome Sound

This chapter explains how to record your performance while you are playing an instrument accompanied by a metronome based on the time signature and tempo specified in the Tempo Map. The metronome sound is output from track 8.

- Initialize the VR800 before the operation.
- If multiple Programs exist, first select the desired Program.

<Notes>

- * When you finish using the Metronome function, turn the function off in SETUP mode.
- * When the Metronome function is on, you cannot record data on track 8, or you cannot play data recorded on track 8.

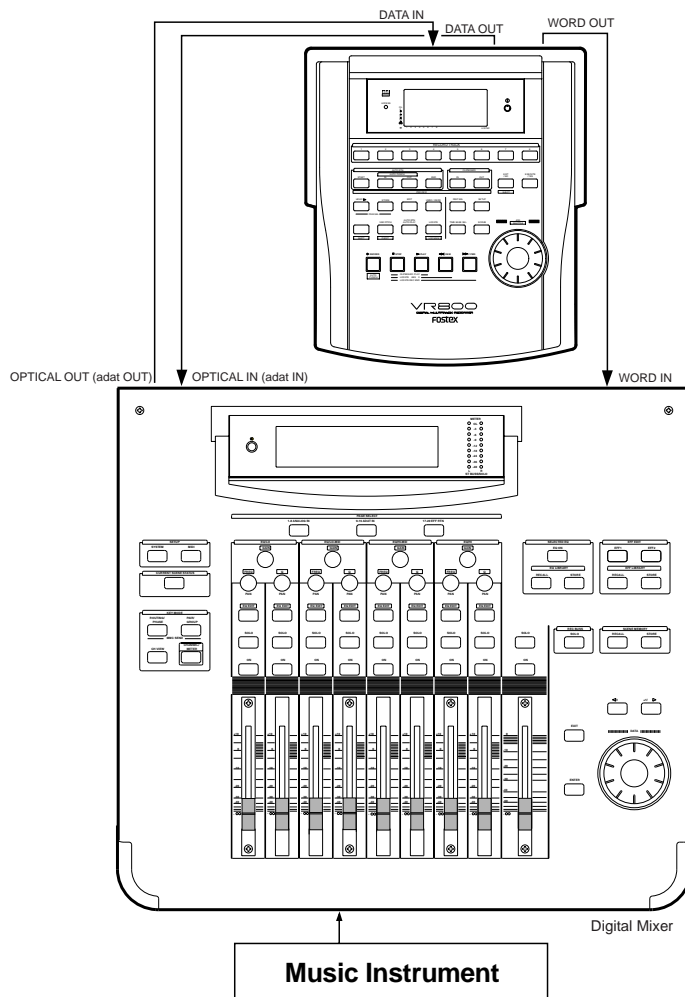

Creating a Tempo Map

- * **Set the time signature using the “Setting a time signature” menu in SETUP mode.**
Refer to the “Setting a time signature” section on page 90.
- * **Set a tempo for a given point using the “Setting a tempo” in SETUP mode.**
Refer to the “Setting a tempo” section on page 92.

Turning the Metronome function on

- * **Turn the Metronome function on using the “Setting the Metronome function” menu in SETUP mode.**
Refer to the “Setting the Metronome function” section on page 93.

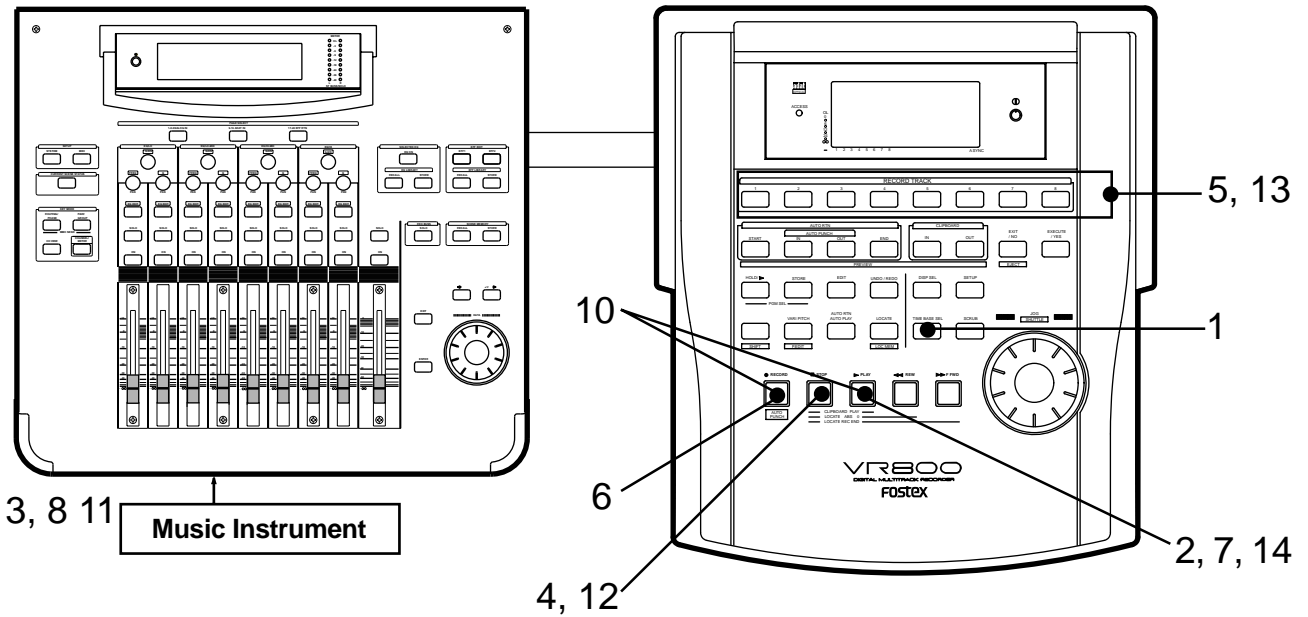

Checking the metronome sound

1. Select the BAR/BEAT/CLK time base using the TIME BASE SEL key.
2. Start playback from the beginning of the Program.
Even if the selected Program does not have any recorded data, track 8 outputs the metronome sound and the VR800 counts time.
3. Adjust the system so the sound output from track 8 can be monitored with the mixer.
You will hear the metronome sound output from track 8 using the Tempo Map created earlier.
4. After confirming the metronome sound, stop the recorder section and return to the top Program.

Adjusting monitor/record level of the musical instrument

5. Press the RECORD TRACK select key of the track to record the musical instrument on, and then put that track in the READY mode.
6. Press the RECORD button.
The lamp of the RECORD button will flash and the READY track will go to the input monitor mode.
7. Press the PLAY button and playback the Program from the top.
Only the READY track will go to the input monitor mode (recording does not take place), and all other tracks will be in the reproduction monitor mode, therefore track 8 plays back the metronome sound.

8. Play the musical instrument in time with the metronome and adjust the recording level of the track to be recorded on the mixer.
9. After adjusting the recording level, stop the recorder and return to the top of the Program.

Starting recording

10. Hold down the RECORD button and press the PLAY button to start recording.
The READY track will go to the input monitor mode just as when the recording level was adjusted. The time the level that was actually adjusted with the mixer will be recorded.
11. Play the musical instrument in time with the metronome.

Quitting recording

12. Press the STOP button to stop the recorder.

Checking the recorded sound

13. Turn OFF the ready track RECORD TRACK select key .
14. Locate the top of the Program and start playback.
Adjust and monitor the track playback sound recorded on the mixer. Since the metronome function still remains ON at this time, you can hear the metronome sound during playback of the recorded sounds when you turn up the track 8 monitor volume.

Digital Recording

Digital recording from an external digital device

This section explains how to record digital data from a device equipped with S/P DIF digital in/out (CD, MD, DAT, etc.) or a device equipped with adat digital in/out.

To record S/P DIF digital signal or adat digital signal, use the “Setting input tracks” menu in SETUP mode to assign the input track. You can record digital data to the current program. The digital input track setting is applied to all programs.

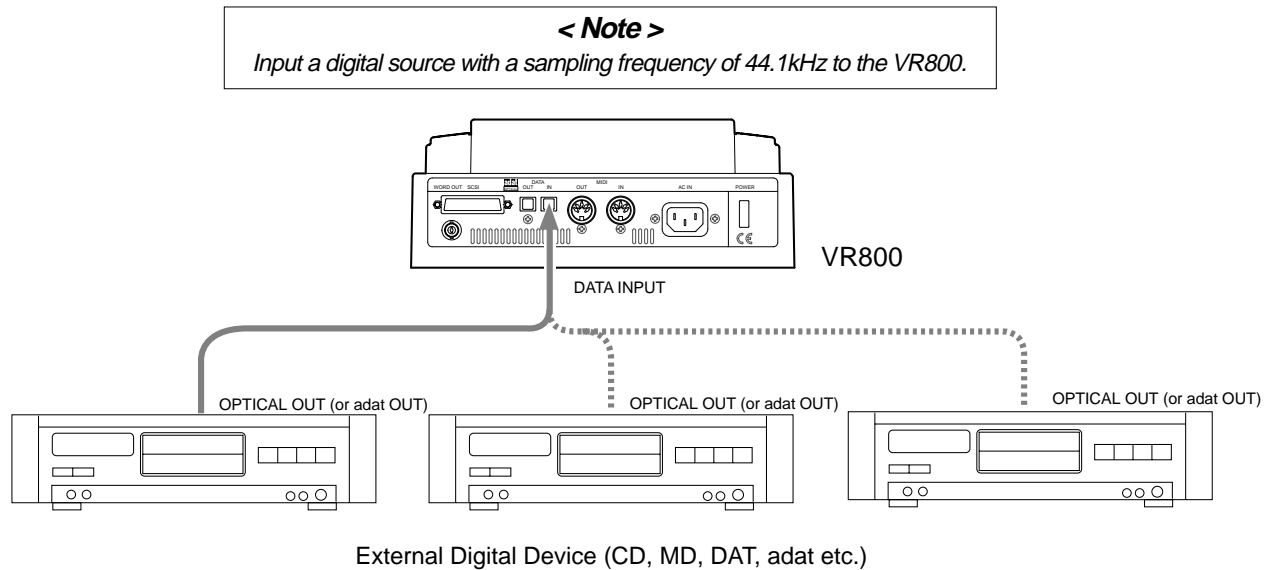

Connecting an external digital device

- * Connect the DATA IN jack of the VR800 with the OPTICAL OUT jack of an external digital device using an optical cable.

If the digital device has only the COAXIAL (RCA pin) jack as a digital output, use a Fostex COP-1 (an optional optical/coaxial converter).

Note: To avoid digital looping, remove the optical cable connected to the DATA OUT connector on the VR800.

Selecting a Program to record

- * If multiple Programs exist, first select the desired Program using the Program Change function.

• See page 33 for more information on Program Change.

Assigning tracks and setting the digital-in clock

- * Use the “Setting a digital input track” menu to assign tracks and set the digital-in clock.

To record adat signals, set the digital input track to [AdAt] and set the digital-in clock to [SYnC] (synchronous mode). To record S/P DIF signals, set the digital input track to any two tracks other than [AdAt], and set the digital-in clock to [SYnC] (synchronous mode).

• See page 101 for more information on Digital input track setting.

When you finish setting the parameters in SETUP mode, be sure to press the EXIT/NO key or the STOP key to exit SETUP mode.

Caution: Do not connect or disconnect an optical cable to or from the DATA IN jack of the VR800 while a track is assigned as digital input. Otherwise, noise may be induced to the VR800, affecting the connected digital device.

Note: When setting up the digital input track, the tracks to be assigned to L and R cannot be the same, such as [L: 4] and [R: 4]. If setup is executed by mistakenly selecting the same track numbers for L and R, the number setup for the L channel will be given priority and " - " (no assign) will be setup automatically.

Note: The [DIGITAL] indicator lights up on the display if the selected digital input track setting (AdAt or any two tracks) matches the type of the incoming digital signal (adat or SP DIF) and if the signal is correctly input. The [DIGITAL] indicator flashes to warn you if the track setting does not match the signal type or if the signal is not input correctly. In this case, check the connection and settings before you start recording.

Selecting a recording track

1. Press the RECORD TRACK select key of the recording track to set that track in ready mode.

Note: You may record four tracks simultaneously on the current drive if it was formatted in [Master 4ch] mode. If you try to record adat digital signals by setting the digital input track to [AdAt], only the RECORD RACK select keys of tracks 1-4 are enabled. (The RECORD TRACK select keys of tracks 5-8 will not function.) That is, only channels 1-4 of the adat digital signals will be recorded. If you are using an MO disk as the current drive, you may record up to two tracks simultaneously, regardless of the record mode of the drive.

Starting and quitting recording

1. Locate the top of the Program.

2. Make sure this [DIGITAL] indicator lights up on the display. Hold down the RECORD button and press the PLAY button to start recording on the VR800.

3. Start playback on the external digital device.

Check to see if the level meter of the VR800 is moving, responding to the input signal.

4. When recording is complete, stop the VR800 and the external digital device.

Digital recording to an external device

This chapter describes how to digitally record data from an external MD, DAT, CD-R or adat that is connected to the VR800 containing the recorded songs. Two voluntary tracks from real tracks 1-8 can be freely assigned to the L and R of the digital output for digital output to an external device. Further, the data of all 8 tracks can also be output (when [adat] is selected). The current program is the program that can be digitally recorded. Note that the "Digital Output Track Setting" is effective for all programs though there may be several programs set at the time.

Note: Data in the additional track cannot be directly digital recorded externally. In order to digital output the data in the additional track, it must first be transferred to a real track (use the track exchange function). For an explanation of the track exchange function, refer to page 66.

< Note >

Output a digital signal with a sampling frequency of 44.1kHz from the VR800.

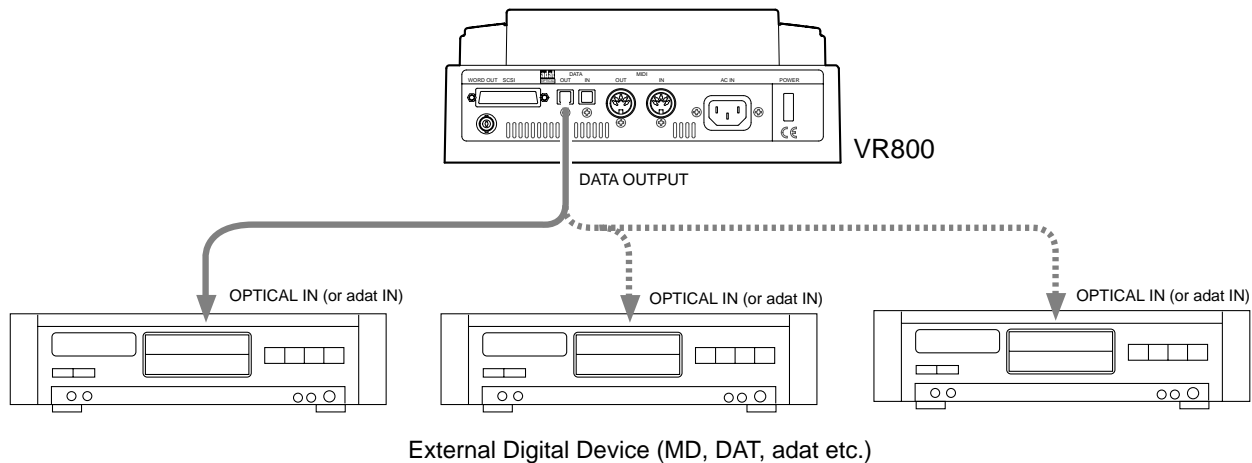

Connecting an external digital device

- * Connect the DATA OUT jack of the VR800 with the OPTICAL IN jack of an external digital device using an optical cable.

If the digital device has only the COAXIAL (RCA pin) jack as a digital output, use an optional COP-1 (optical - coaxial converter).

Note: The VR800 switches the DATA OUTPUT connector between an S/P DIF digital signal (Optical) and an adat digital signal during setting of the digital input track in Setup mode. Both signals use the same connector configuration, but carry different data.

Note: To avoid digital looping, remove the optical cable connected to the DATA IN connector on the VR800.

Selecting a playback program

- * If multiple Programs exist, first select the desired Program using the Program Change function.

• See page 33 for more information on Program Change.

Setting a digital output track

1. Select the desired track using the “Setting digital output tracks” menu in SETUP mode.

You can select any two track (S/P DIF digital signal) from tracks 1–8, or all eight tracks (adat digital signal). Refer to “Setting digital output tracks” in the “Changing the Initial Settings (SETUP Mode)” chapter on page 103 for more information on setting a digital output track. When you finish setting the parameters in SETUP mode, be sure to press the EXIT/NO key or the STOP key to exit SETUP mode.

Note: When setting up the digital output track, the tracks to be assigned to L and R cannot be the same, such as [L: 4] and [R: 4]. If setup is executed by mistakenly selecting the same track numbers for L and R, the number setup for the L channel will be given priority and “–” (no assign) will be setup automatically for R. In other words, L channel will be setup to the specified track and R channel will be setup to no assign.

Note: You may play four tracks simultaneously from disks formatted in Master 4ch mode. Even if you set the digital output track to [AdAt], only tracks 1-4 will be output, and tracks 5-8 will be ignored.

Starting and quitting recording

1. Locate the top of the Program.
2. Start recording on the external digital device.
3. Press the PLAY button on the VR800 to start playback.
Digital data is output from the selected track and recorded on the external digital device.
4. When recording is complete, stop the VR800 and the external digital device.

Storing a Locate Point (Edit Point)

You can store specific individual time data (time, bar/beat/clock) in each memory key (*). The time data stored is used as an "Editing Point" to execute "Locate Point" or Auto Punch In/Out, Copy & Paste, Move & Paste or Erase. You can also store 99 (Locate Number 01-99) time data in the LOCATE key, in addition to the Memory key, to enable locate only features. This chapter will describe how to store specific data in the memory key and how to edit and re-store data is already stored in the memory key. The data stored in each memory are used for the following operations.

*** Memory key**

When you set the IN/OUT points for Auto Punch In/Out, IN/OUT points for Copy & Clip/Move & Clip, and START/END points for Auto Return/Auto Repeat, END points.

AUTO PUNCH IN key	<ul style="list-style-type: none"> * Locating the AUTO PUNCH IN point. * Recording start point for the Auto Punch In/Out operation. * Paste start point for the Copy & Paste or Move & Paste operation. * Erase start point for the Erase operation.
AUTO PUNCH OUT key	<ul style="list-style-type: none"> * Locating the AUTO PUNCH OUT point. * Recording end point for the Auto Punch In/Out operation. * Erase end point for the Erase operation.
CLIPBOARD IN key	<ul style="list-style-type: none"> * Locating the CLIPBOARD IN point. * Copy start point for copying or moving data to the clipboard during the Copy & Paste or Move & Paste operation.
CLIPBOARD OUT key	<ul style="list-style-type: none"> * Locating the CLIPBOARD OUT point. * Copy end point for copying or moving data to the clipboard during the Copy & Paste or Move & Paste operation.
AUTO RTN START key	<ul style="list-style-type: none"> * Locating the AUTO RTN START point. * Locate end point from AUTO RTN END in Auto Return or Auto Repeat modes.
AUTO RTN END key	<ul style="list-style-type: none"> * Locating the AUTO RTN END point. * Locate start point to AUTO RTN START in Auto Return or Auto Repeat modes.

<Note on storing the locate point>

When you set the IN/OUT points for Auto Punch In/Out, IN/OUT points for Copy & Clip/Move & Clip, and START/END points for Auto Return/Auto Repeat, make sure that IN points precede the OUT points and START points precede the END points.

You can also store time data in the LOCATE key, in addition to each memory key explained above. You can store up to 99 individual time data in the LOCATE key for locate only features. Store the data by specifying Locate Number to locate the intended time data. Note that the LOCATE key always stores the last located time data in real-time. This Locate Number is stored as 00, and does not require a Locate Number specification to locate it.

Simply pressing the LOCATE key directly, will locate that data. This becomes an advantage since it is possible to repeatedly locate the last located point.

You can edit the data stored in the LOCATE key, as so with the data stored in the Memory key. For more details refer to page 57.

* You can store locate points for each Program. (You need to select a Program first.)

* The data can be also saved or loaded even after the Song data is saved or loaded.

* All locate points stored in the memory keys will be maintained after you turn off the VR800.

Storing and editing the locate points to the memory keys

- Select the desired Time Base using the TIME BASE SEL key and if you wish to use a Time Base other than ABS.
- The stored or edited locate points are used only in the currently-selected Program.

Storing in real-time

You can store the locate point (in the ABS, MTC, or BAR/BEAT/CLK Time Base) in real-time while the VR800 is playing.

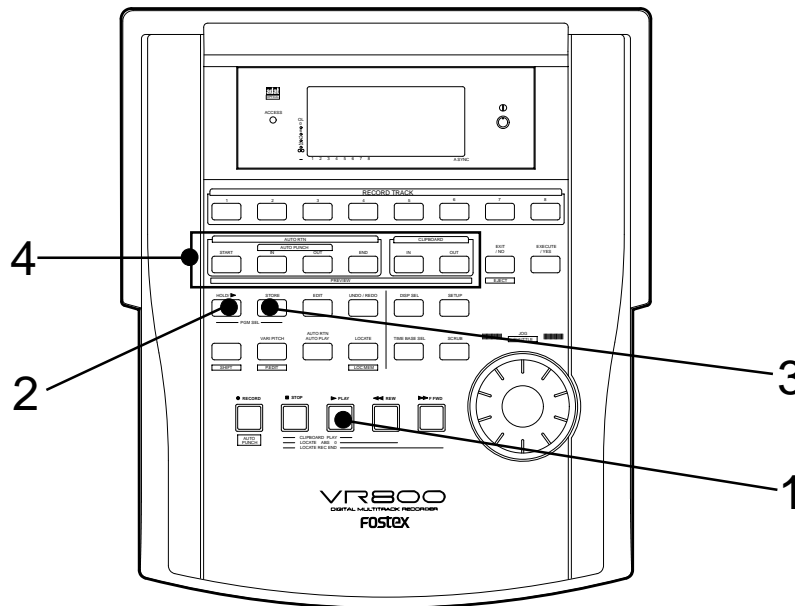

1. Press the PLAY button to play back data.

2. When the point you wish to store is reached, press the HOLD/> key.

The time value or bar/beat/clock value of the point is captured. The VR800 enters data edit mode.

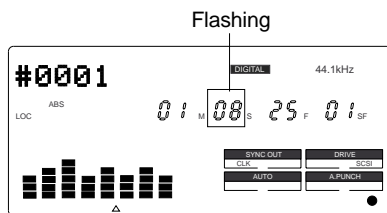

3. Press the STORE key.

The STORE key lamp lights up.

Note: The following menu (##=number from 00-99) appears when pressing the STORE key. This menu is used to store data in the LOCATE key, described later. Ignore this menu and go to the next step when storing data in the memory key.

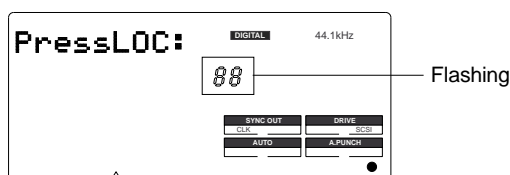

4. Press the desired memory key.

The STORE key lamp turns off.

The captured time value (or bar/beat/clock value) is stored in the memory key. After the data is stored, the VR800 displays the previous Time Base and continues playback.

- You can omit Step 2 to speed operation.

5. Press the STOP button.

- If you set "BAR/BEAT Resolution mode" in SETUP mode to ON, the VR800 will round off the CLK value of the captured bar/beat/clock value. That is, the locate point will be at the beginning of the beat (00). Refer to page 103 for more information.

Editing and storing locate data

If you know the position of the desired locate point, follow the steps below.

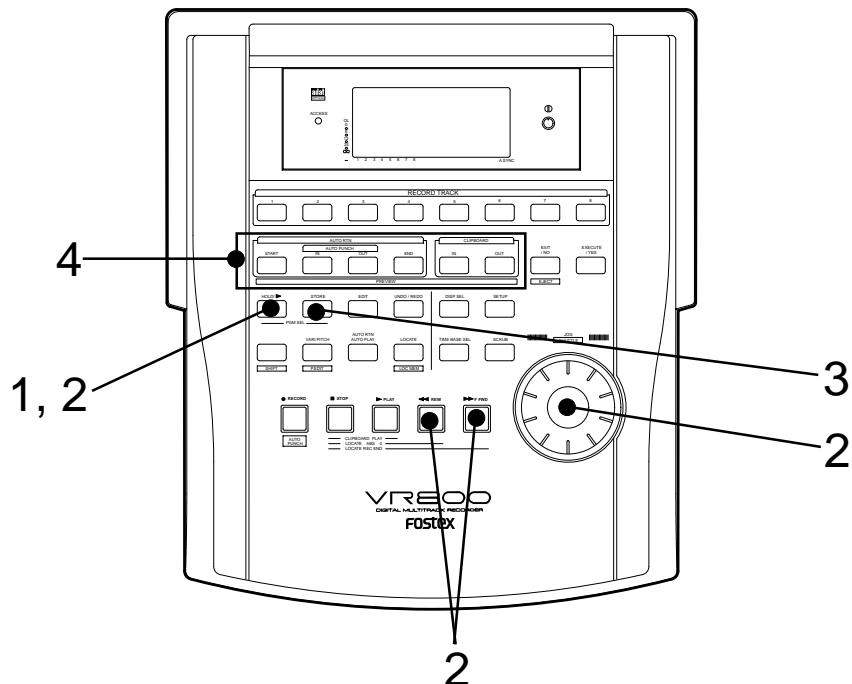

- 1. Press the HOLD/> key while the VR800 is stopped.**
The currently-displayed time value (or bar/beat/clock value) is captured and the VR800 enters data edit mode.

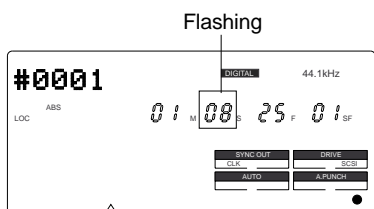

- 2. Press the HOLD/> key, REWIND button, or the F FWD button to move the flashing cursor on the time value digit, and use the JOG dial to increase or decrease the value.**

- 3. Press the STORE key.**
The [Press LOC:] menu will appear as indicated before. Ignore this go to the next step.

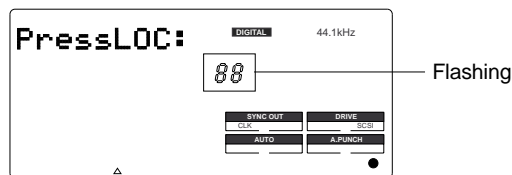

- 4. Press the desired memory key.**
The STORE key lamp will turn off. The input time value (or bar/beat/clock value) is stored in the corresponding memory key.

Editing and storing data

You can recall data stored in the memory key, edit it, and store it. again

- 1. While the VR800 is stopped, press the memory key that stores the data you wish to edit.**
The stored data appears on the display and the VR800 enters data edit mode.
- 2. Press the HOLD/> key, REWIND button, or the F FWD button to move the flashing cursor on the time value digit, and use the JOG dial to increase or decrease the value.**
- 3. Press the STORE key.**
The [Press LOC:] menu will appear as indicated before. Ignore this go to the next step.
- 4. Press the memory key that you pressed in Step 1 again.**
The STORE key lamp will turn off. The edited data is stored, and the VR800 displays the previous Time Base indication.

- You can store the edited data in a memory key other than the one you pressed when you recalled the data. For example, you can recall the AUTO PUNCH IN point data, edit it, and store it to the AUTO PUNCH OUT key.
 - * Refer to page 36 for more information on Auto Punch In/Out.
 - * Refer to page 61 for more information on Copy & Paste, Move & Paste, and Erase.
 - * Refer to page 54 for more information on Auto Return and Auto Repeat.
- You can also use the Preview function to edit the stored locate points (edit points). Refer to "Preview Function" on page 59 for more information.

Storing and editing LOCATE key

You can store up to 99 individual time data in the LOCATE key for Locate only operations. The time data stored can also be assigned with a specific locate number from 01-99. This means the desired locate number can be specified to locate that specific time data. The memory data of the LOCATE key can also be edited in the same manner as the data in the Memory key. After editing the data the LOCATE key can locate that point, or even be re-stored as data for other Memory keys.

<Note>

- * The last data located with the Memory key or LOCATE key is constantly stored as LOCATE number 00. However, this data is constantly replaced after every LOCATE command. Therefore, do not use Locate Number 00 for independent Locate data.
- * You cannot preview the data stored in the LOCATE key, though it is possible to preview data stored in other Memory keys.
- * If you use a time base that is not an ABS time, there is a need to priority switch to the desired time base using the TIME BASE SEL key.
- * Any editing or storing of data for the LOCATE point is valid only for the program that is currently started up.

Storing in real-time

You can store the locate point (in the ABS, MTC, or BAR/BEAT/CLK Time Base) in real-time while the VR800 is playing.

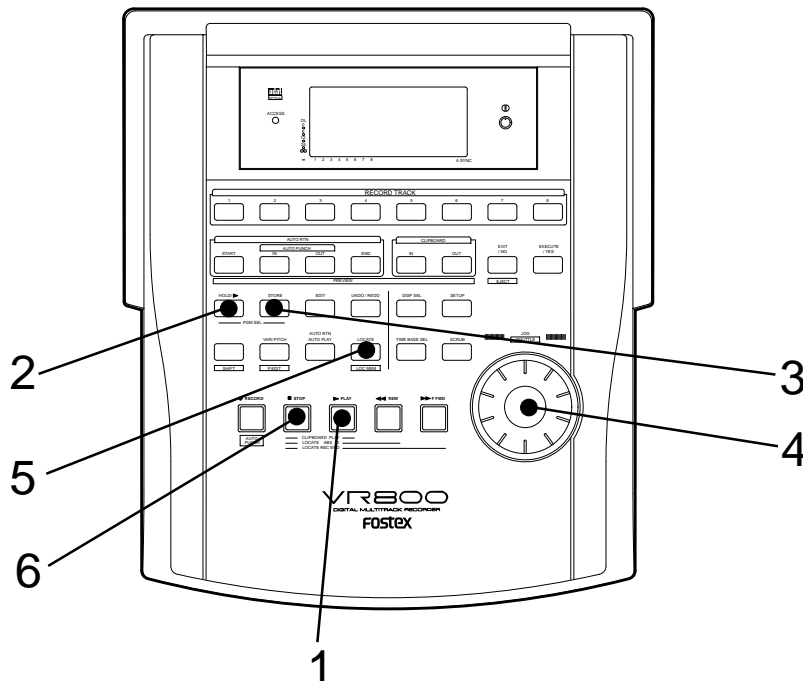

1. Press the PLAY button to start playback.

2. Press the HOLD/> key in the store location.

When you press the HOLD/> key the time base (or bar/beat/clock) will return to the edit mode of the data put on hold.

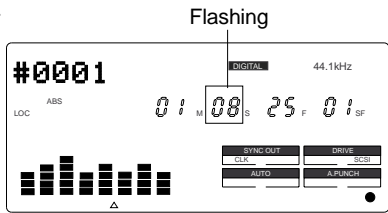

3. Press the STORE key. (the STORE key lamp lights up)

The memory number selection menu will appear, as follows.

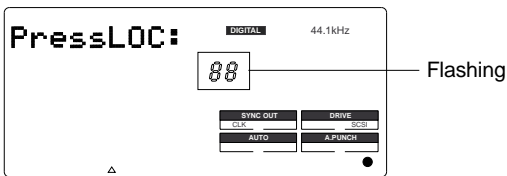

4. Select the LOCATE number desired using the JOG dial.

LOCATE number from 00-99 are selectable. However, select a number other than 00.

5. Next press the LOCATE key.

The time base (or bar/beat/clock) put on hold is stored as data in the LOCATE number selected. The system will return to the original time base when the storage process is completed, and playback is resumed.

6. After completing the store process, press the STOP button to stop the recorder section.

- You can omit Step 2 to speed operation.

- If you set "BAR/BEAT Resolution mode" in SETUP mode to ON, the VR800 will round off the CLK value of the captured bar/beat/clock value. That is, the locate point will be at the beginning of the beat (00). Refer to page 103 for more information.

Editing and storing locate data

If you know the position of the desired locate point, follow the steps below.

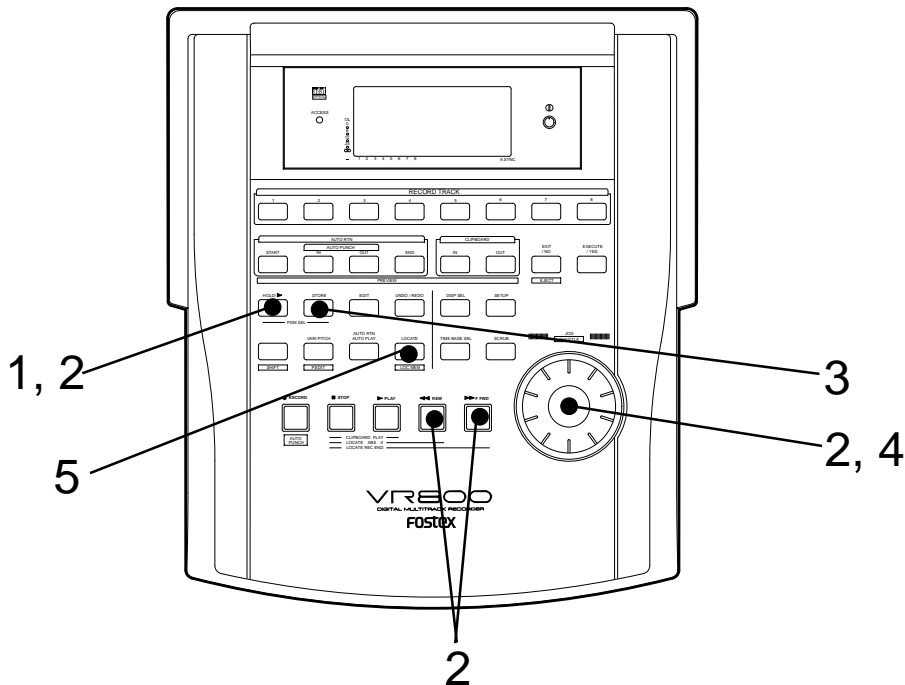

1. Press the HOLD/> key while the VR800 is stopped.

The currently-displayed time value (or bar/beat/clock value) is captured and the VR800 enters data edit mode.

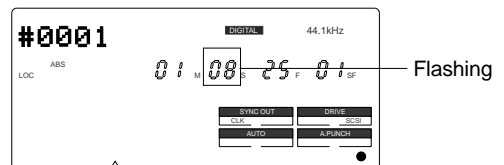

2. Press the HOLD/> key, REWIND button, or the F FWD button to move the flashing cursor on the time value digit, and use the JOG dial to increase or decrease the value.
3. Press the STORE key. (the STORE key lamp lights up.)
4. Select the LOCATE number desired using the JOG dial.
5. Press the LOCATE key.
The edit time data is stored as the time data for the selected LOCATE number.

Edit and re-store data that is already stored

RECALL the desired time data already stored in the LOCATE key, edit that data and re-store it.

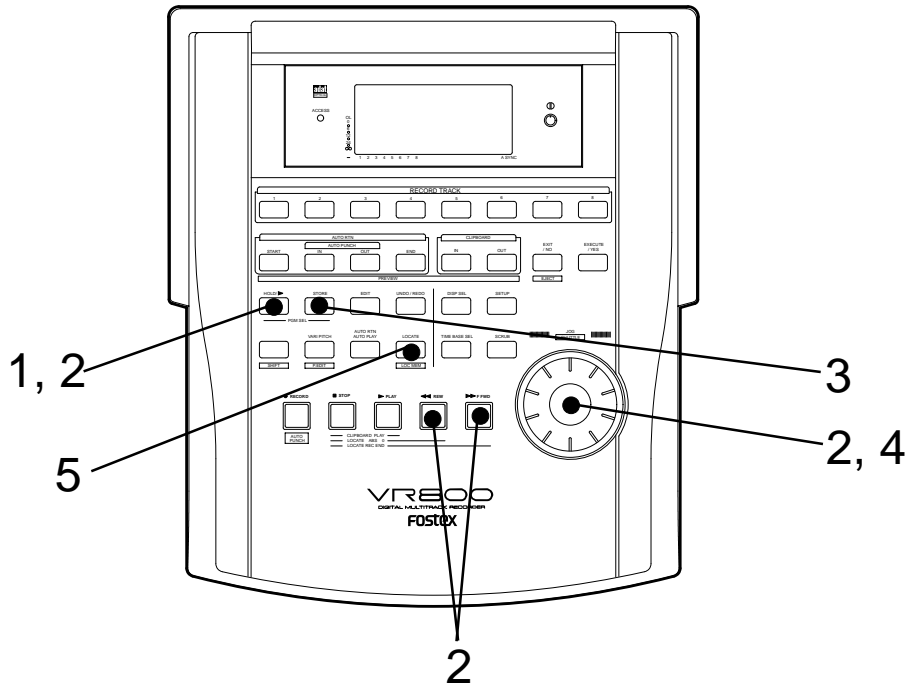

1. Press the LOCATE key, while holding down the SHIFT key, while the VR800 is stopped.
The menu to select the LOCATE number will appear.

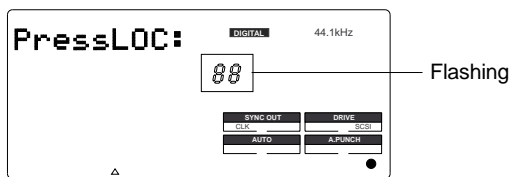

•If the STORE key is press instead of the LOCATE key at this stage, it becomes possible to directly LOCATE the time data of the selected LOCATE number. For more details refer to the next section on "Location Functions."

2. Turn the JOG dial to select the desired LOCATE number, then press the LOCATE key.
The data edit mode will appear when the data stored in the selected LOCATE number appears.

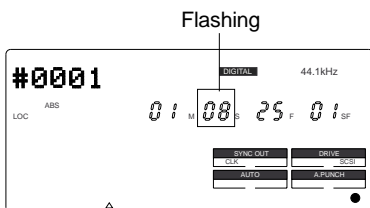

5. You can use the JOG dial to input the desired LOCATE number.
6. Press the LOCATE key.
The edit time data is stored as the time data for the selected LOCATE number.

Locate Function

The VR800 swiftly locates (it moves the current location of the recorder section) the desired point when necessary. Locate include edit points (in ABS time, MTC time, or in bar/beat/clock) that are stored for the Copy, Move, Paste, Erase, or Auto Punch In/Out operations.

They also include Locate by specifying a voluntary time, and Locate specifying a voluntary Locate Number (01-99), as well as Locate directly to the recording end point in a Program (REC END). An application of the Locate function includes auto functions such as Auto Play, Auto Return and Auto Repeat.

Direct Locate

The Direct Locate function enables you to locate the following points:

• Locate the beginning of the Program (LOCATE ABS 0)

Press the REWIND button while holding down the STOP button.

The VR800 will immediately locate the beginning of the currently-selected Program.

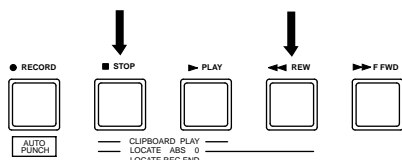

• Locate the recording end point of the Program (LOCATE REC END)

Press the F FWD button while holding down the STOP button.

The VR800 will immediately locate the end point of the currently-selected Program.

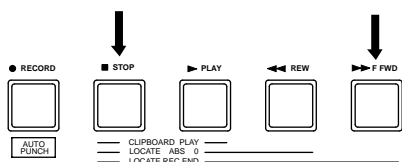

• Locate the position stored in one of the memory keys

Press the desired memory key, then press the LOCATE key.

The VR800 will locate the point (edit point) stored in the corresponding memory key immediately.

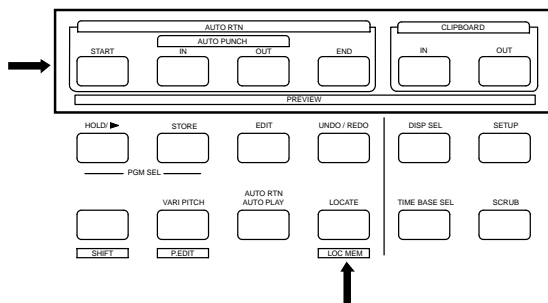

The located time data is always stored as time data in locate number "00."

• Specify the locate number to locate data

1. Press the LOCATE key, while holding down the SHIFT key.

The locate number selection menu appears.

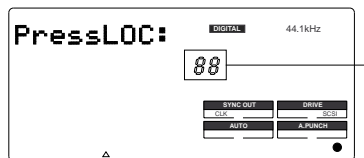

2. Turn the JOG dial or press the LOCATE key, while holding down the SHIFT key to select the desired number.

3. Press the LOCATE key once.

The time stored in the selected locate number appears.

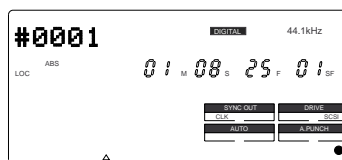

4. Press the LOCATE key again.

The time data of the selected locate number is swiftly located. The located time data is constantly stored as time data in locate number "00."

• Locate a specified point

Refer to "Editing and storing locate data" in the chapter "Storing a Locate Point (Edit Point)" for information on how to edit the data and on pressing the LOCATE key instead of the STORE key. The point at specified time value (or bar/beat/clock value) will be located immediately.

• Locate the last-located point

Directly press the LOCATE key.

The time data of Locate number 00 is located. Locate number 00 is always update with the last data located (excluding LOCATE ABS 0 and LOCATE REC END). Therefore, you will locate the data in memory number 00 every time you directly press the LOCATE key.

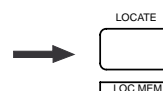

Auto Play

The Auto Play function allows the VR800 to start play back automatically from the located point. AUTO PLAY mode should be turned on before you execute the Direct Locate function described above.

Note: This function is effective within 24 ABS hours. Therefore, if playback continues over the recording end point, the VR800 will still continue counting the time. Also, when the VR800 locates ABS REC END, it will continue counting the time from the recording end point. (However, the VR800 does not access the disk after reaching the recording end point.)

<Example: Operation at locating to the AUTO PUNCH IN point.>

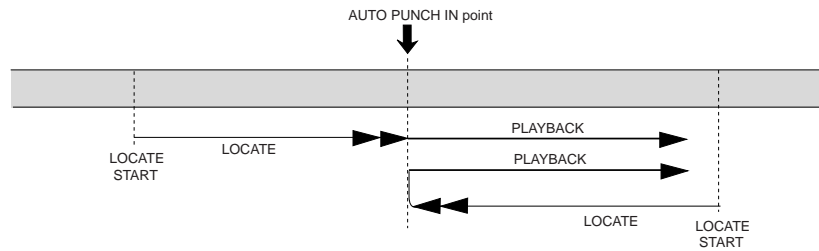

1. Press the **AUTO RTN/AUTO PLAY** key to turn on the **[PLAY]** indicator on the bottom of the display.



2. Press the **LOCATE** key, or memory key.

The VR800 locates the point and plays as shown in the diagram.

- You can set a preroll time in the [Preroll Time ?] menu in SETUP mode so that the VR800 will start playback preroll time before the locate point. You can set the preroll time from 0 to 10 seconds. Refer to the chapter "Changing the Initial Settings (SETUP Mode)" on page 94.

3. Press the **STOP** button to stop the VR800.

Auto Return

This function allows the VR800 to play data up to the AUTO RTN END point, then automatically locate the AUTO RTN START point as shown in the diagram below. To enable this function, AUTO RTN mode should be on and the AUTO RTN START point and AUTO RTN END point should already be set.

<Operation of the Auto Return mode.>

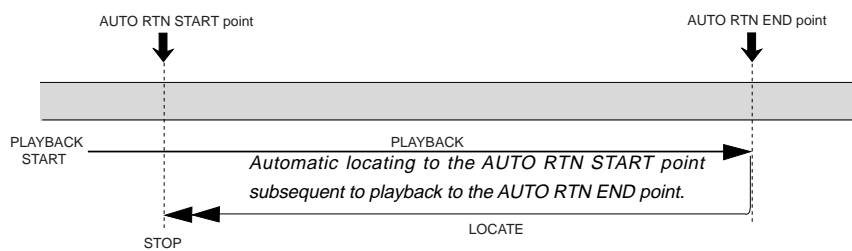

1. Store the **AUTO RTN START** and **AUTO RTN END** points.

Refer to the chapter "Storing a Locate Point (Edit Point)" on page 48 for information on storing the desired points in the AUTO RTN START key and the AUTO RTN END key.

2. Press the **AUTO RTN/AUTO PLAY** key to turn on the **[RTN]** indicator on the bottom of the display.



3. Start playback a little before the **AUTO RTN END** point.

The VR800 operates as shown in the diagram.

- You can set a preroll time in the [Preroll Time ?] menu in SETUP mode so that the VR800 will start playback preroll time before the locate point. You can set the preroll time from 0 to 10 seconds. Refer to the chapter "Changing the Initial Settings (SETUP Mode)" on page 94.

Auto Repeat

The Auto Repeat function allows the VR800 to repeat playback up to the AUTO RTN END point, automatically locate the AUTO RTN START point, then play up to the AUTO RTN END point until you cancel the function by pressing the STOP button. To enable this function, both AUTO PLAY mode and AUTO RTN mode should be turned on, and the AUTO RTN START point and the AUTO RTN END point should already be set.

Using this function will facilitate the Auto Punch In/Out and Manual Punch In/Out rehearsal. See “Hint” after the following section.

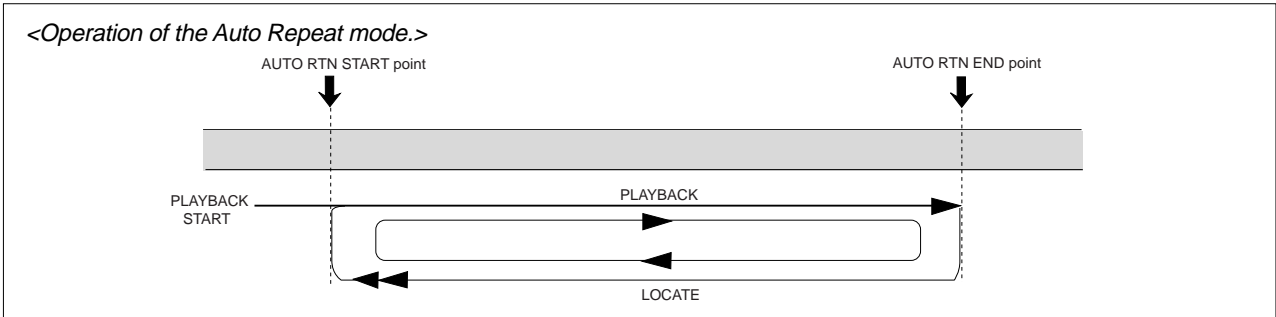

1. Store the AUTO RTN START and AUTO RTN END points.

Refer to the chapter “Storing a Locate Point (Edit Point)” on page 48 for information on storing the desired points in the AUTO RTN START key and the AUTO RTN END key.

2. Press the AUTO RTN/AUTO PLAY key to turn on the [PLAY] and [RTN] indicator on the bottom of the display.

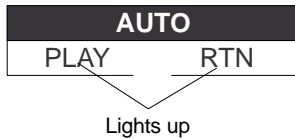

3. Start playback a little before the AUTO RTN START point.

The VR800 operates as shown in the diagram, and stops at the AUTO RTN START point.

- You can set a preroll time in the [Preroll Time?] menu in SETUP mode so that the VR800 will start playback preroll time before the locate point. You can set the preroll time from 0 to 10 seconds. Refer to the chapter “Changing the Initial Settings (SETUP Mode)” on page 94.

<Hint>

You can make repeated Auto Punch In/Out rehearsal much easier and quicker by using the Auto Repeat function. Set the AUTO RTN START point prior to the AUTO PUNCH IN point, and set the AUTO RTN END point after the AUTO PUNCH OUT point. The recorder will repeat the operation automatically so you can concentrate on your rehearsal. Cancel Auto Repeat mode before you record a take.

The VR800 will play this range repeatedly for rehearsal, which makes it easy for you to check the recording level and practice your performance.

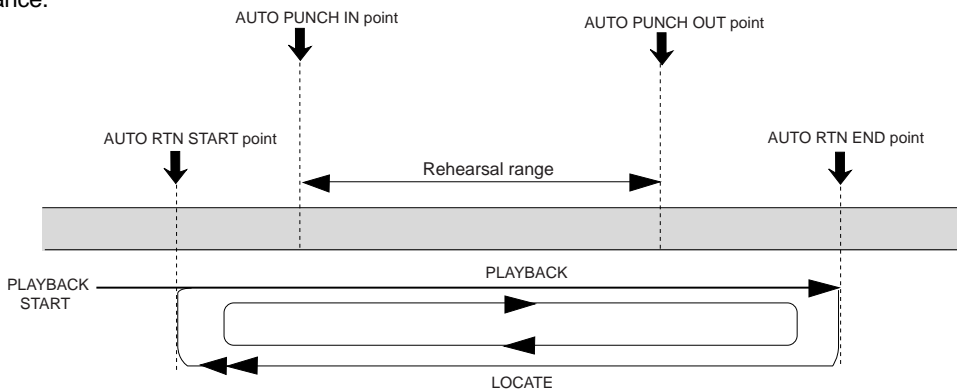

Cue & Review Function

This chapter explains how to use the “Cue & Review” function with the REWIND button, the F FWD button, and the SHUTTLE function, and also explains “Digital Scrubbing” with the scrub mode function. During Cue/Review and Digital Scrubbing you will hear the sound recorded on the disk, which makes it easy for you to swiftly locate the desired point without failure while listening to the sounds.

The prerequisite of the following operation is that the time base is ABS, however, the operation can be executed in any time base. To execute this function with a non-ABS time base there is a need to priory switch over to the desired time base.

Cue & Review function using the REWIND and F FWD buttons

You may cue & review the audio data at three-times speed while the recorder is playing.

1. Press the PLAY button to play the audio data.

2. Press the F FWD button during playback.

[FWD>] appears on the display, and the VR800 cues in the forward direction at three-times speed.

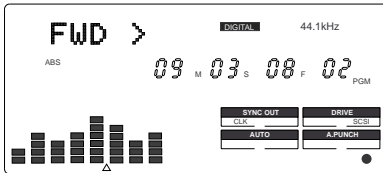

3. Adjust the monitor sound of the track to monitor on the mixer.

4. Press the PLAY button again to restore the original play back speed.

5. Press the REWIND button instead of the F FWD button.

[<RWD] appears on the display, and the VR800 cues in the reverse direction at three-times speed.

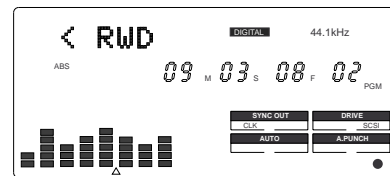

6. Press the PLAY button to restore the original playback speed.

Cue & Review function using the SHUTTLE feature

You can use the SHUTTLE mode for 1-time~64-times Cue/Review while playing back the recorder section.

1. Press the PLAY button to start playback.

2. Hold down the SHIFT key and turn the JOG dial clockwise or counter-clockwise.

Turning the JOG dial clockwise will change the cueing speed. Turning the JOG dial counter-clockwise will change the reviewing speed.

The VR800 displays the selected cue or review speed, which you can select from normal, two-times, four-times, eight-times, 16-times, 32-times, and 64-times speed.

As long as you are holding down the SHIFT key, playback continues at the selected speed.

3. Adjust the monitor sound of the track to monitor on the mixer.

4. Release the SHIFT key to cancel the cue and review operation.

The VR800 resumes playback at the original speed.

Display of 16-times review

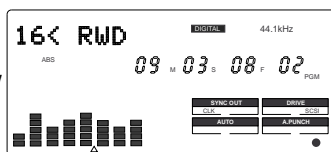

Display of 32-times cue

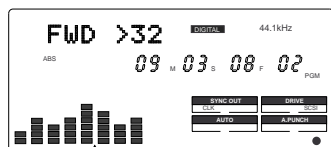

Note: The cue and review operation does not affect pitch. Because the VR800 performs this function by skipping part of data during playback.

Note: When the beginning of the disk is reached during the review operation, the VR800 starts normal playback, even if you are still holding down the SHIFT key. When the end of the disk (ABS time: 23H 59M 59S) is reached during the cue operation, the VR800 stops and the PLAY button lamp flashes.

Digital scrubbing using the SCRUB function

You may perform digital scrubbing using the “SCRUB Function” of the VR800 while the recorder section is stopped. The scrub function allows digital scrubbing for each track recorded. The display will show the envelope indication of the track selected.

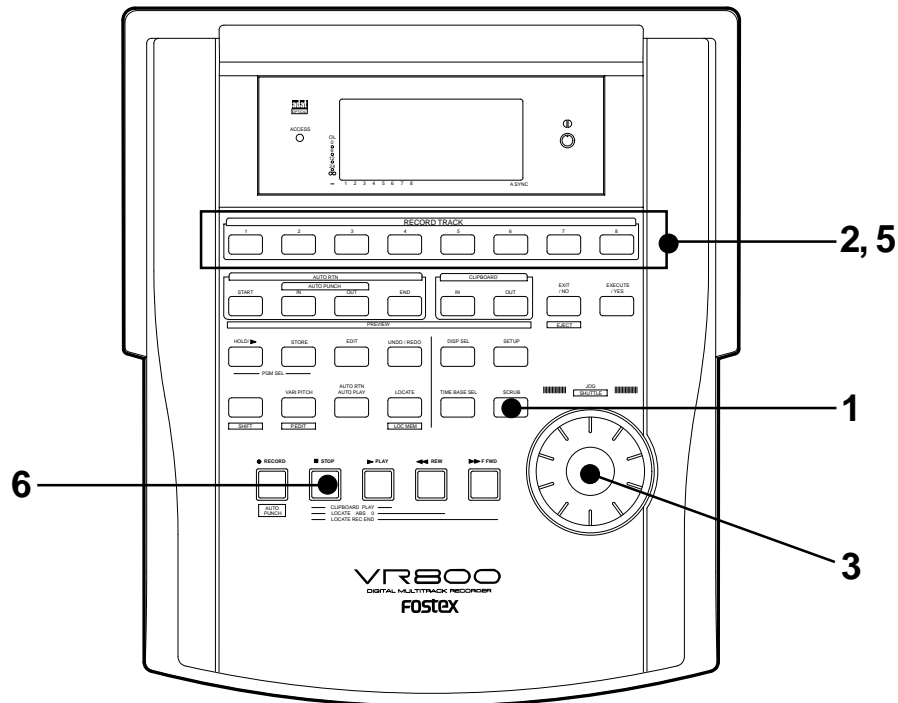

1. Press the SCRUB key while the VR800 is stopped.

The SCRUB key's lamp lights up. The VR800 enters scrub mode and displays [Select TRK], instructing you to select the desired track.

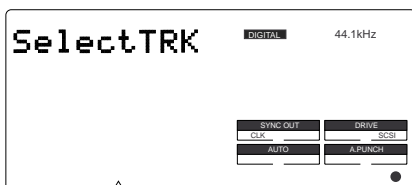

Note: You can select one track at a time. If you try to select two or more RECORD TRACK select key, the VR800 will ignore your operation.

2. Press the desired RECORD TRACK select key to select a track for digital scrubbing.

The screen changes, indicating that the VR800 is in “STILL” status (Scrub mode is “still”). The selected RECORD TRACK select key's lamp flashes.

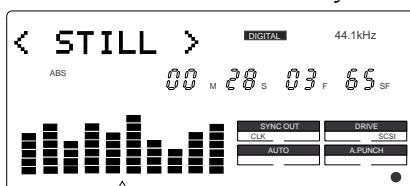

3. Turn the JOG dial to perform digital scrubbing.

The envelope of data recorded on the selected track appears during digital scrubbing.

<Turning the JOG dial in the forward direction>

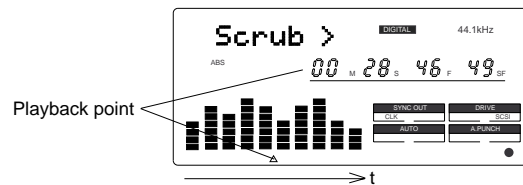

<Turning the JOG dial in the reverse direction>

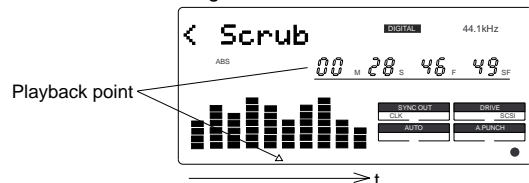

4. Adjust the monitor sound of the selected track so that it can be monitored on the mixer.

5. Press the RECORD TRACK select key of the desired record track to select another track.

[Please Wait!] will briefly appear and then go to the envelope indication of the selected track.

6. Press the STOP button to stop the digital scrubbing.

Doing so will turn OFF the scrub mode. The VR800 will return to the time base indication prior to turning the envelope function ON.

Preview Function

The preview function enables you to repeatedly audition the rise (fade in) or the fall (fade out) of the sound data at a locate point (edit point) that is stored in the AUTO PUNCH IN/OUT, AUTO RTN START/END, or CLIPBOARD IN/OUT key. This is also called “point rehearsal.” With this function, you can check the locate points in real-time. You can also use this function to fine-tune the position of the locate points while previewing the sound. This function is effective only when the VR800 is stopped.

Executing the Preview function

Previewing the rise of the sound (fade in)

1. While holding down the **SHIFT** key, press the **AUTO RTN START** key, the **AUTO PUNCH OUT** key, or **CLIPBOARD IN** key.

The VR800 repeats playback the “rise sound” at the locate point (edit point).

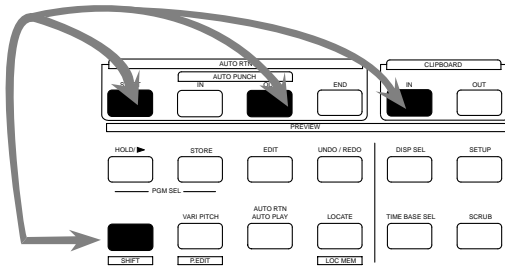

Previewing the fall of the sound (fade out)

1. While holding down the **SHIFT** key, press the **AUTO END START** key, the **AUTO PUNCH IN** key, or the **CLIPBOARD OUT** key.

The VR800 repeats playback of the “fall sound” at the locate point (edit point).

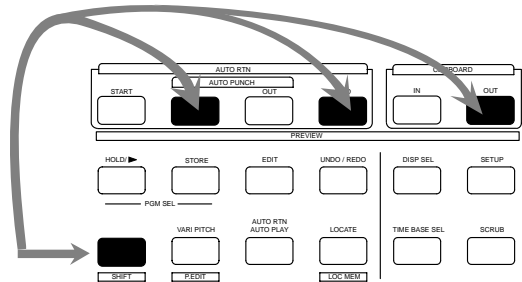

<Display indication during the Preview operation>

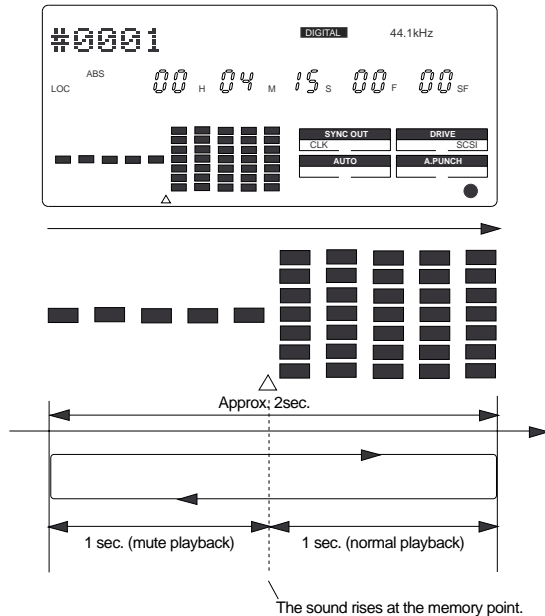

As shown in the diagram, one-second of data prior to the locate point is muted during playback. The mute is off (fade in) at the locate point and the sound is played back for one second.

The VR800 will repeat this operation until you quit the Preview function.

<Display indication during the Preview operation>

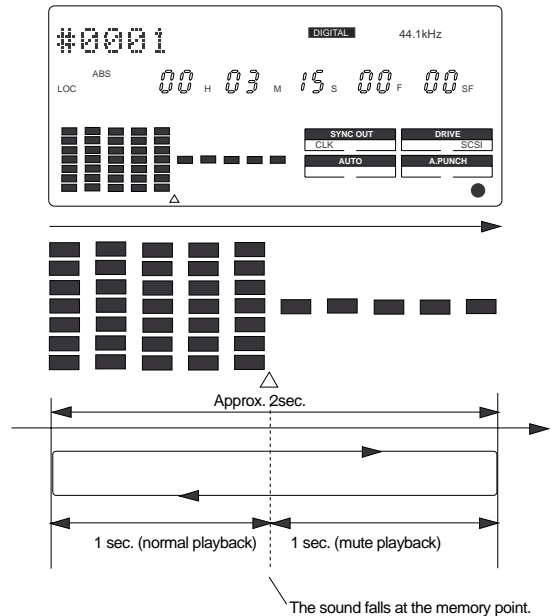

As shown in the diagram, one-second of data prior to the locate point is played back, then muted (fade out) at the locate point. The muted playback continues for one second. The VR800 will repeat this operation until you quit the Preview function.

2. To adjust the monitor sound of the selected track so that it can be monitored on the mixer.

3. Press the STOP button or the EXIT/NO key.

Note: If data stored in each memory key is in the initial state, all memory keys will be in ABS time 00H 00M 00S. In other words, the program head value is in the memory. Should fade out preview be executed in this condition, the [Void Data !] message and memory data [00H 00M 00S] will alternately flash in the display as a warning. However, for fade in preview, this will function as the memory data [00H 00M 00S] point.

Trimming the sound while previewing

You can trim the position of the locate point (edit point) using the JOG dial while you preview the sound. At this time, you can also adjust the size of the trimming steps (the amount of offset controlled by the JOG dial). Trimming allows you to fine-tune the position of the locate point stored in the memory keys while previewing the sound.

Use this function to change the Auto Punch In/Out points, the start point of Copy & Paste and Move & Paste, and the start and end points of the Erase function.

- <Notes>**
- You can audition the result of trimming during the next preview. That is, if you trim the position while previewing the sound for the first time, you can check the result when you preview the sound next time.
 - If the locate point is shifted outside the range of the preview playback as a result of trimming, [Void Data!] and the locate point indication appear alternately. In this case, you cannot use the Preview function. Trim the position again so that it will be within the playback range.
 - When Auto Punch mode is turned on and you trim the Auto Punch In or Auto Punch Out point while previewing the sound with [Void Data!] indicated on the display, Auto Punch mode will be cancelled.

1. Start previewing the sound by following the steps described on the previous page.

3. To change the unit of trimming, press the HOLD/> key, the REWIND button, or the F FWD button.

2. Use the JOG dial to trim the position.

These buttons will change the trimming unit as follows:

When previewing starts, the unit of JOG trimming flashes on the screen. For example, value of SF (sub-frame) flashes if ABS Time Base or MTC Time Base is selected. CLK (clock) flashes if BAR/BEAT/CLK is selected. The flashing value also indicates the position you can trim.

	Time Base	
	ABS or MTC	BAR/BEAT/CLK
HOLD/> key or F FWD button		
REWIND button		

Example: Time Base is ABS (value of SF flashes.)

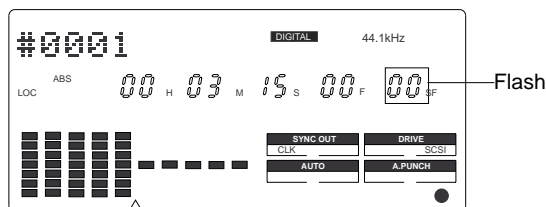

Example: Time Base is BAR/BEAT/CLK (CLK flashes.)

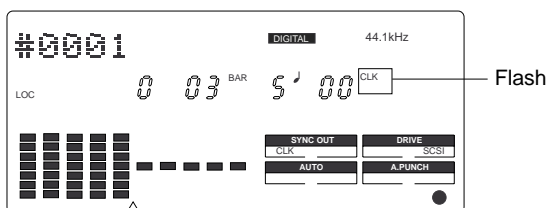

4. Trim the position at the selected unit (digit).

5. Press the STOP button or the EXIT/NO key.

The trimmed locate point (edit point) data will be stored in the corresponding memory key.

Editing Tracks

The VR800 features speedy, non-linear, non-destructive editing of independent audio tracks and uses a zip, MO disk, fixed hard disk or 3.5-inch E-IDE hard disk as the recording media. The following edit functions enable you to edit tracks. Press the EDIT key on the control panel to access the edit menu.

<Edit functions>

Copy & Paste

You can copy a specific range of data from a specific track and paste it to the same or a different track.

Move & Paste

You can move a specific range of data from a specific track and paste it to the same or a different track.

Erase

You can erase a specific range of data from a specific track or from all tracks.

Track Exchange

You can swap data between tracks. Monaural track data can be swapped between Real tracks 1–8 and Additional tracks 9–24. Multiple-track data can be swapped between Real tracks 1–8 and Additional tracks 9–16, and Additional tracks 17-24 by eight-track unit.

Note: These edit functions are available for the currently-selected Program. You can perform Copy & Paste, Move & Paste, and Erase operations (except for Track Exchange) for data recorded in the Real tracks. If the disk contains multiple Programs, you need to select the desired Program first to perform the track edit operation. Do not select another Program until you finish the edit operation. Otherwise, you may lose or incorrectly edit another Program.

Copy & Paste and Move & Paste

Copy & Paste and Move & Paste might seem like the same function. However, they are different, as shown in the diagram. Remember this difference when you start using these functions.

• Copy & Paste

Using the Copy & Paste function enables you to copy a specific range of data from a specific track to the clipboard as shown below (this is called [Copy Clip] operation on the VR800), then paste the data at a specific point in a specific track. The number of copy source tracks and the number of destination tracks are the same. That is, if you copy mono track data, you can paste it to a mono track. If you copy adjacent odd/even tracks (e.g., track 1 and track 2), you can paste it to adjacent odd/even tracks. The data on the clipboard remains as it is. You can paste it as many times as you wish.

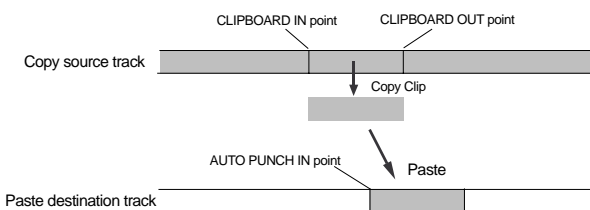

• Move & Paste

Move & Paste is almost the same as Copy & Paste. As shown in the figure, it allows you to move a specific range of data from a specific track to the clipboard (this is called [Move Clip] on the VR800), and paste it to a destination track. The difference from Copy & Paste is that the data on the source track and the clipboard will be erased when you paste the data to the destination. That is, you cannot paste the moved data repeatedly.

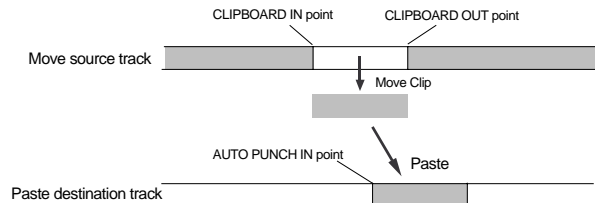

As shown in the drawing, points for copy or move are called the CLIPBOARD IN point for the copy (or move) starting point, and CLIPBOARD OUT point for the ending point, and the paste starting point is called the AUTO PUNCH IN point.

Follow the steps below to perform the Copy & Paste or Move & Paste operation.

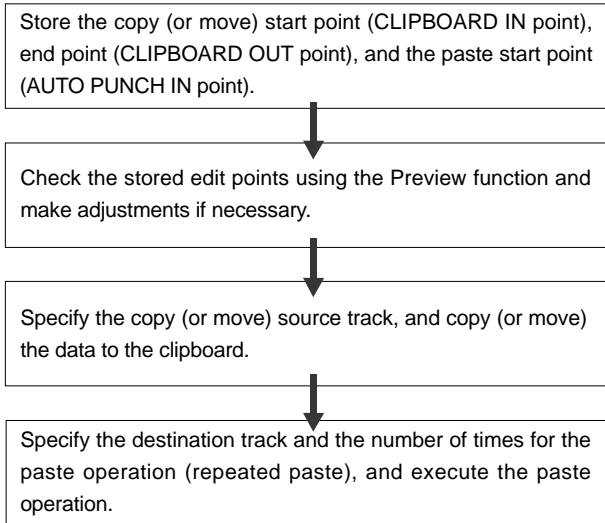

Storing the edit points

1. Refer to the “Storing and editing the locate points to the memory keys” section for information on storing the copy (or move) start and end points, and the paste start point.

Store the copy (or move) start point to the CLIPBOARD IN key, the end point to the CLIPBOARD OUT key, and store the paste start point to the AUTO PUNCH IN key.

• See “Storing and editing the locate points to the memory keys” on page 48.

Checking and adjusting the edit points

After you store the edit points, you can check them on the display by pressing the corresponding keys. You may also adjust the points. This section explains how to preview and fine-tune the edit points using the Preview function.

1. While the recorder section is stopped, press and hold down the SHIFT key and press the memory key for which you wish to check the edit point.

You can preview “fade in” at the CLIPBOARD IN point, “fade out” at the CLIPBOARD OUT point, and “fade out” at AUTO PUNCH IN point.

2. Trim the edit point while previewing.

• Refer to “Preview Function” on page 59 for more information.

Executing Copy (or Move)

1. Press the RECORD TRACK select key of the copy (or move) source track to set it READY.

Select from mono tracks or adjacent odd-even tracks (1-2, 3-4, 5-6, 7-8).

Note: If you select non-adjacent tracks, such as tracks 1 and 3, or tracks 1, 2, and 4, the copied (or moved) data will be pasted back to the copy (or move) source tracks.

2. Press the EDIT key repeatedly until [Copy Clip (or [Move Clip]) flashes on the display.

Select [Copy Clip] to execute Copy & Paste.
Select [Move Clip] to execute Move & Paste.

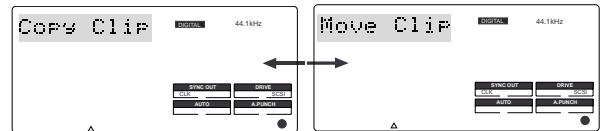

3. Press the EXECUTE/YES key.

The copy or move operation will complete immediately. The display briefly indicates [COMPLETED !], then flashes the [Copy Paste] message (or the [Move Paste] message). The VR800 enters standby mode for the paste operation. The lamps of the selected RECORD TRACK select keys continue to flash.

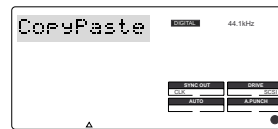

This is indicated after copy/clip.

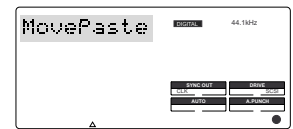

This is indicated after move/clip.

Note: Pressing the EXECUTE/YES key without selecting a track in Step 1 will cause the display to indicate an alarm message [Select TRK !]. Select a track, then press the EXECUTE/YES key.

Now the sound data to be pasted has been copied (or moved) to the clipboard, you can check the data on the clipboard by following the steps below. If there is no problem with the data, you can proceed to the paste operation.

Checking the clipboard data

- * Hold down the STOP button and press the PLAY button. The VR800 indicates whether the sound data on the clipboard is a copied data or moved data ([Copy Clip] or [Move Clip]) and plays the data (this is called clipboard playback). Monitor the playback sound through the mixer channels that correspond to the copied (or moved) tracks. During clipboard playback, the lamp of the RECORD TRACK select key for the copied (or moved) track will flash.
- * Press the EDIT key again to get ready for the paste operation. [Copy Paste] or [Move Paste] flashes on the display.

Executing Paste

4. Press the EXECUTE/YES key again.

The display indication enables you to set the number of the paste operations. The number and [SURE ?] flash. At this time, the flashing RECORD TRACK select key's lamp becomes continuously lit.

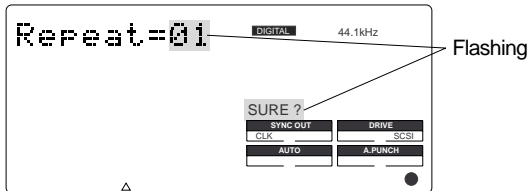

5. Select a destination track to paste data.

All selected tracks' lamps light up.

You can select only mono tracks as the destination of a copied or moved mono track. If you copied or moved adjacent odd-even tracks, you can select only adjacent odd-even tracks as the destination.

If you do not select any tracks, the data will be pasted back to the copy or move source track.

6. Turn the JOG dial to enter the number of repeats (Repeat=**).

You can enter up to 99. However, this is automatically limited by the available recording space on the disk. That is, if the disk has enough free space, you can set up to 99 repeats. If the disk has only a small amount of free space, the JOG dial allows you to set a lower number of repeats.

7. Press the EXECUTE/YES key.

[Copy Paste] (or [Move Paste]) flashes and the duration of the pasted data appears as a negative number on the display. This number will count down as the paste operation proceeds.

When the paste operation is complete, the flashing [Copy Paste] (or [Move Paste]) lights up continuously, and [COMPLETED !] is displayed.

Note: If you try to execute the paste operation by pressing the EXECUTE/YES key when the disk has insufficient free space, [Over !] appears on the display and edit mode is cancelled. In this case, you need to delete unnecessary data or Programs. Refer to the following section, "Erase," and to "Deleting a Program" on page 34 for more information on erasing.

8. Press the STOP button or the EXIT/NO key.

The VR800 exits edit mode and displays the previous Time Base indication.

9. Turn off the RECORD TRACK select key of the copy (or move) source track.

Undo/Redo Paste

You can undo or redo a Copy & Paste and Move & Paste operation.

- To restore the data that existed prior to the paste operation, press the UNDO/REDO key.
- To restore the pasted data after you undo the paste operation, press the UNDO/REDO key again.

Note: The Undo/Redo function is effective only when the VR800 is stopped.

Note: If you perform one of the following operations after you use the Copy & Paste or Move and Paste operation, the Undo/Redo function will no longer be effective.

1. When a new recording is made.
2. When a new editing is executed (such as Copy & Paste, Move & Paste, Erase).
3. While in the AUTO PUNCH ON mode, when the AUTO PUNCH IN point is passed in the PLAY (or RECORD) mode.
4. When the power is momentarily switched off.
5. When the program is changed.
6. When ejecting a removable SCSI disk that is the current drive..

Erase

There are two methods for erasing data. Understand the difference between these methods before you use the Erase function.

* If multiple Programs are set on the disk, first select the desired Program. Do not select another Program until you finish the erase operation.

• Erasing a specified part of the data between ABS 0 and REC END

You may erase a specified part of the data between ABS 0 and REC END (the end point of the recording) in the currently-selected Program. (The erased part is replaced with silence.) You can erase data on a mono real track or multiple real tracks. To erase data on an additional track, you need to move the data to a real track, then erase it. As shown below, the REC END point (the end point of recording) is not affected. The erased area is replaced with silence. As a result, the REMAIN time and space will increase. (You will have more recordable space on the disk.)

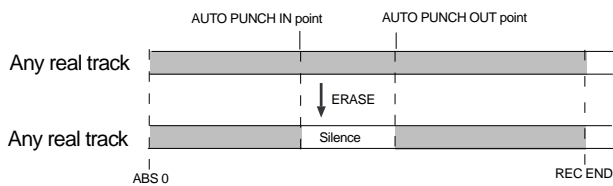

• Erasing data from a specified point to REC END

You may erase all data in the range from a specified point to REC END in the currently-selected Program. You can erase data on a mono real track or multiple real tracks. To erase data on an additional track, you need to move the data to a real track, then erase it. When you erase all tracks' data, the REC END point will move backward. However, if you erase data on a mono track or multiple tracks (but not all tracks), the REC END point may not be affected. (Refer to the note below.) After the erase operation, the REMAIN time and space will increase.

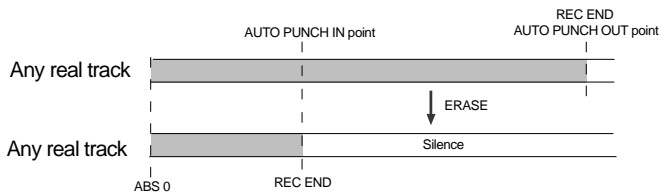

Note: If all real tracks contain data as shown below, erasing data on tracks 1 and 2 will not affect the position of REC END. On the other hand, if all Real tracks contain data as shown below, erasing data on tracks 3 - 8 will move up REC END to the end point of tracks 1 and 2.

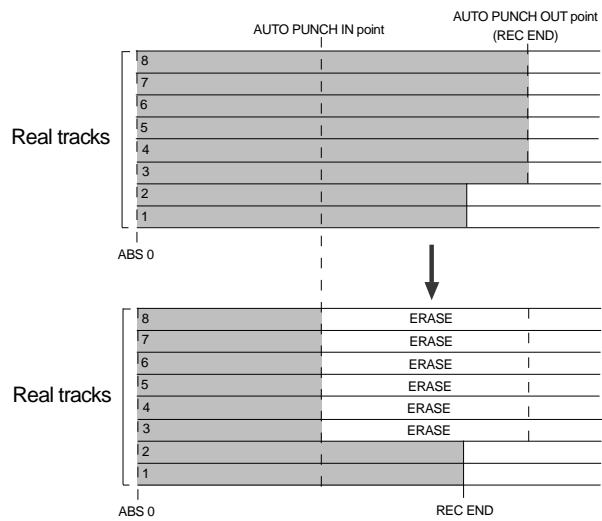
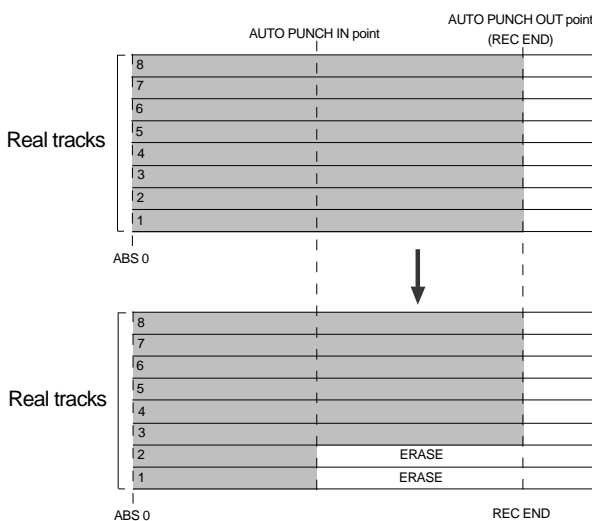

Follow the steps below to erase data:

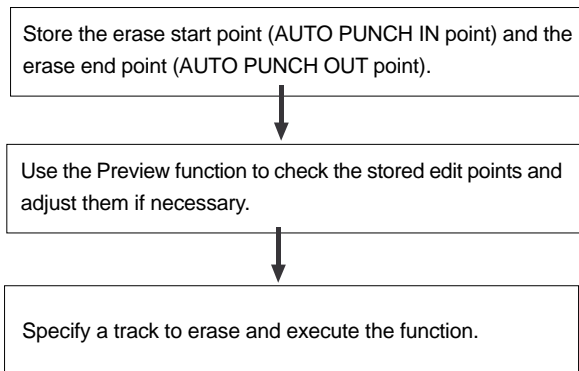

Storing the edit points

1. Refer to the “Storing and editing the locate points to the memory keys” section for information on storing the erase start and end points.

Store the erase start point to the AUTO PUNCH IN key, and the end point to the AUTO PUNCH OUT key.

- If you wish to erase the data from a specific point, store the REC END or later point as the erase end point. Refer to the <Note> for information on storing the REC END point.
- See “Storing and editing the locate points to the memory keys” on page 48.

Checking and adjusting the edit points

After you store the edit points, you can check them on the display by pressing the corresponding keys.

You may also adjust the points.

1. While the recorder section is stopped, press and hold down the SHIFT key and press the memory key for which you wish to check the edit point.

You can preview “fade-out” at the AUTO PUNCH IN point and “fade-in” at AUTO PUNCH OUT point.

2. Trim the edit point while previewing.

- Refer to “Preview Function” on page 59 for more information.

Executing Erase

1. Press the RECORD TRACK select key of the track to erase to set it READY.

You can select a mono track, multiple tracks, or all tracks.

2. Press the EDIT key repeatedly until [Erase] flashes on the display.

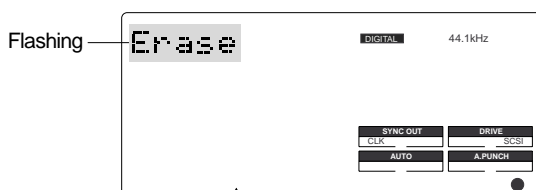

3. Press the EXECUTE/YES key.

The flashing [Erase] message lights up steadily, and [SURE ?] flashes.

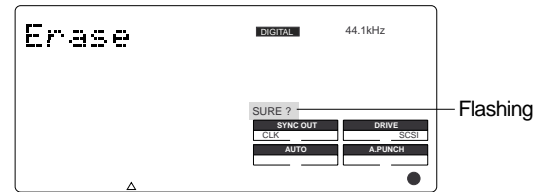

To cancel the erase operation, press the STOP button or the EXIT/NO key while [SURE ?] flashes on the display.

4. Press the EXECUTE/YES key again.

The VR800 starts erasing the data and [Erase] flashes. When the erase operation is completed, [COMPLETED !] lights up.

5. Press the STOP button or the EXIT/NO key.

The VR800 exits edit mode and displays the previous Time Base indication.

- To erase the data in its entirety from the tracks, you can also use the Program Delete function to erase the entire Program. In either case, you can expand the recordable area on the disk. Use either one of the erase operations to erase unnecessary data if the VR800 displays an alarm message indicating insufficient recordable space for Auto Punch In/Out, Copy & Paste, or Move & Paste.
- Refer to “Deleting a Program” on page 34 for more information on the Program Delete function.

Undo/Redo Erase

You can undo or redo the Erase operation.

- To restore the data that existed before you erased it, press the UNDO/REDO key.
- To restore the data after you undo the Erase operation, press the UNDO/REDO key again. When you press the UNDO/REDO key, the VR800 will undo or redo the operation immediately, and display [Undo!] or [Redo !] and [COMPLETED !].

Note: The Undo/Redo function is effective only when the VR800 is stopped.

Note: If you perform one of the following operations after you use the Copy & Paste or Move and Paste operation, the Undo/Redo function will no longer be effective.

1. When a new recording is made.
2. When a new editing is executed (such as Copy & Paste, Move & Paste, Erase).
3. While in the AUTO PUNCH ON mode, when the AUTO PUNCH IN point is passed in the PLAY (or RECORD) mode.
4. When the power is momentarily switched off.
5. When the program is changed.
6. When ejecting a removable SCSI disk that is the current drive.

Track Exchange

The Track Exchange function enables you to swap mono track data or multiple track data of the current Program between Real tracks and Additional tracks in units of single or multiple tracks.

You can swap mono track data between Real tracks, Additional tracks, or between a Real track and an Additional track. You can swap multiple track data between eight Real tracks (1-8) and Additional tracks (9-16 or 17-24). Refer to the diagrams below for information on how data on the tracks can be moved using this function.

The Track Exchange function also enables you to move Real track data to an empty Additional track (to empty the original Real track) so that you can use the Real track for a new recording. This capability lets you use tracks more flexibly.

You need to move data on an Additional track back to a Real track to audition the data, since data on an Additional track cannot be played in real-time.

You can also use this function when you wish to check the REC END point of an Additional track, as described in the "Erase" section.

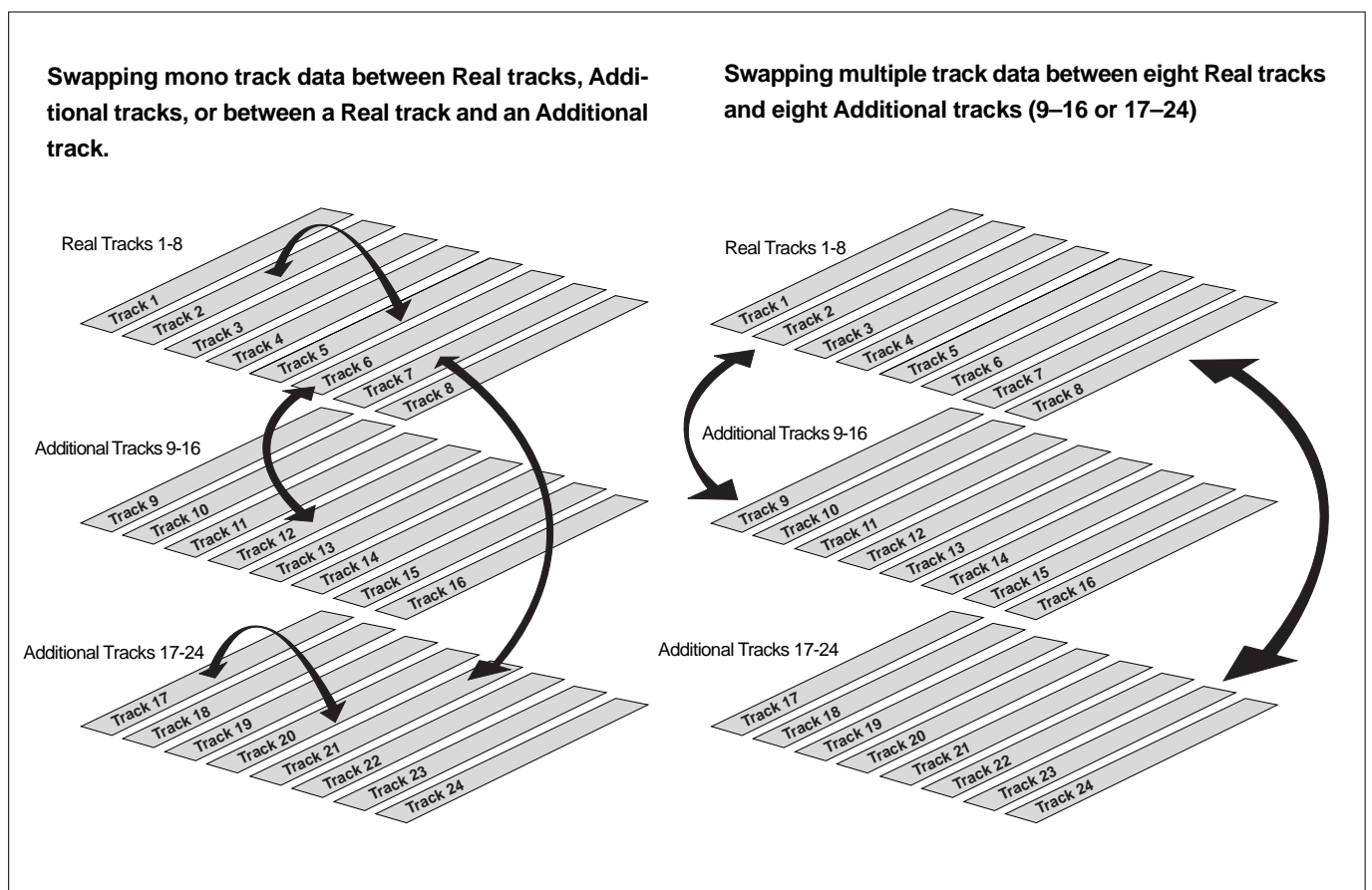

Executing Track Exchange

1. While the VR800 is stopped, press the EDIT key repeatedly until [TRK Exchg] flashes on the display. Alternatively, you can press the EDIT key, then use the JOG dial.

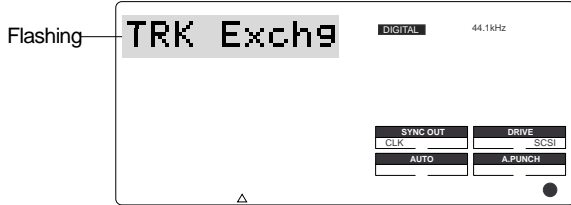

2. Press the EXECUTE/YES key.

The display shows the track selection. The current display shows that you can swap eight-track data between Real tracks 1-8 and Additional tracks 9-16. If you wish to select other tracks, follow the steps below.

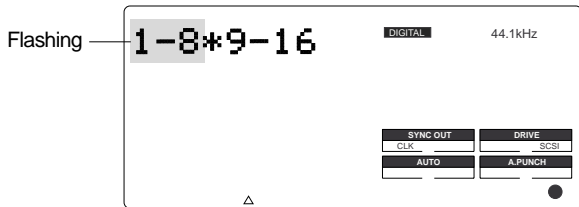

3. Select the tracks to swap data.

- Selecting Real tracks 1-8 and Additional tracks 17-24:

1. Press the HOLD/> key, the REWIND button, or the F FWD button to move a flashing cursor on [1-8] (left) to [9-16](right).

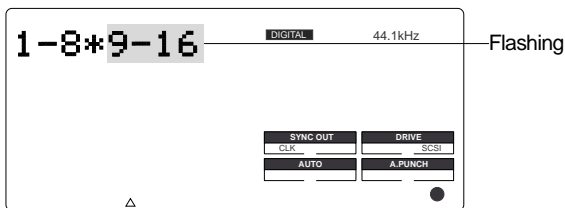

2. Turn the JOG dial to change flashing [9-16] to flashing [17-24].

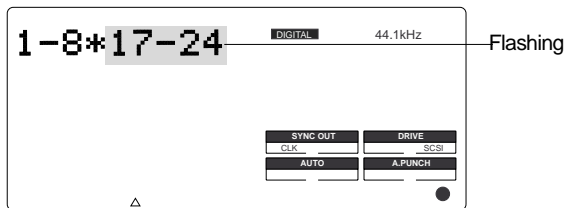

- Swapping mono track data between any two tracks

1. When [1-8] is flashing, turn the JOG dial.

Turning the JOG dial allows you to select a mono track from [1], [2], [3], [4]..... [24] in the left column. The right column continues a mono track. For example, if you select [4] in the left column, the display indicates [4<>1], meaning you can swap data between tracks 4 and 1.

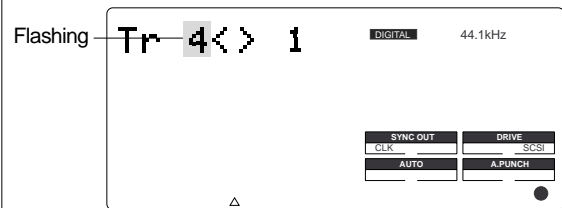
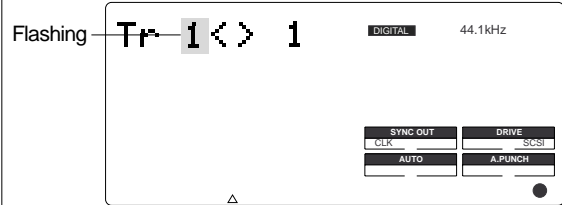

2. To select a number in the right column, press the HOLD/> key, the REWIND button, or the F FWD button to move the flashing cursor to the right column, then use the JOG dial to select the desired number.

* When you swap data between mono tracks, the indications [4<>1] and [1<>4], for example, mean the same thing — swapping data between tracks 1 and 4.

Note: If you select the same tracks for swapping mono track data, the setting is ignored. The VR800 will indicate [Select Err] for a short moment, then return to the previous display.

4. Press the EXECUTE/YES key.

[Exchange] lights up and the swapping operation is completed immediately. The VR800 indicates [COMPLETED !], then returns to the previous Time Base display.

Data on the additional tracks, as it stands, cannot be played back or its REC END confirmed. To do this, the data must be temporarily moved to a real track. If the additional track data, which is longer than the real track (1~8) data is to be saved to DAT or adat, the longer time data must be replaced to the real track. Please refer to "Save/load" for details.

MIDI sync function

The following are examples concerning general types of systems using MIDI related functions contained in the VR800.

MIDI clock sync system

By setting any desired meter at any desired point of the programmable tempo map contained in the VR800, and by output of a MIDI clock and song position pointer according to the setting, a hardware type MIDI sequencer can be synchronized as a MIDI clock slave. Consequently, in this system, the VR800 will be the master and the MIDI sequencer the slave.

- * Restore the default settings on VR800.
- * Check for the correct program and proper sampling frequency.

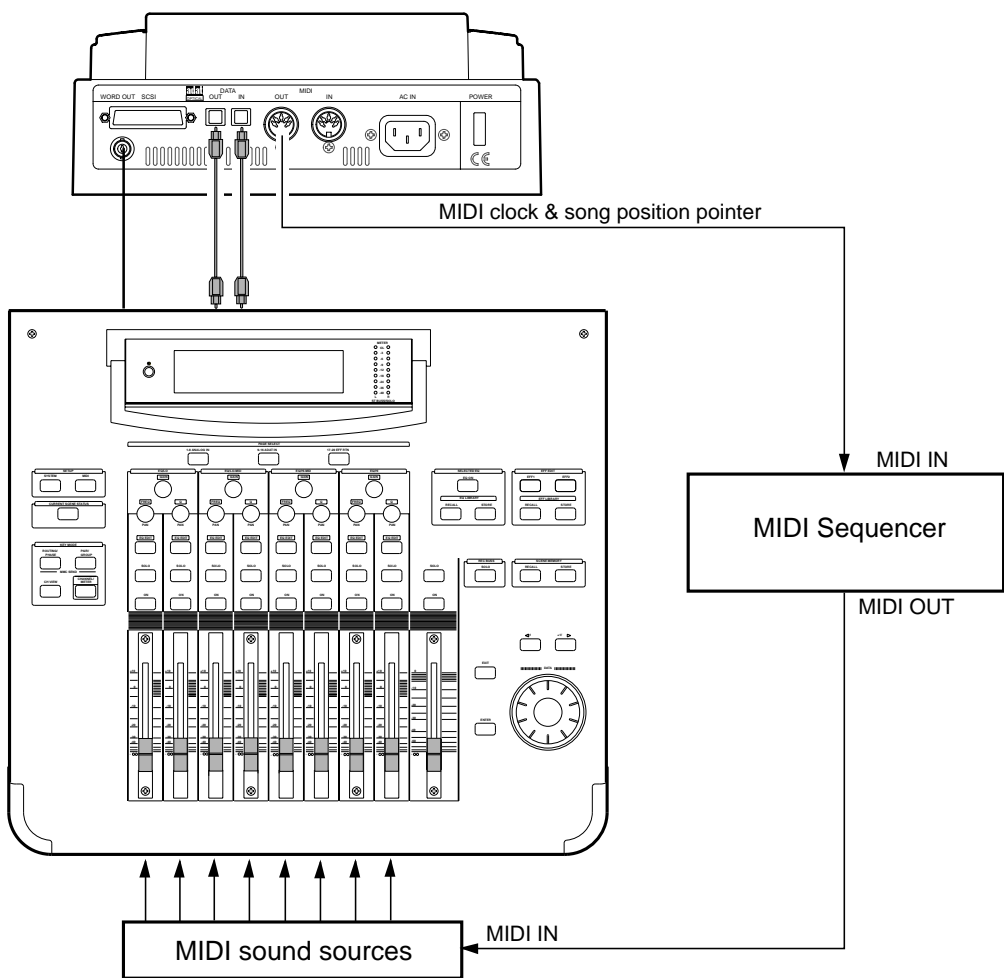

Connecting external equipment (Refer to connecting schematic)

1. Connect the VR800 MIDI OUT to MIDI IN of the MIDI sequencer.
2. Set the MIDI sequencer for "external sync mode (EXTERNAL SYNC) by MIDI clock."
 * Refer to the Owners Manual of the equipment in use for details.

Setup of VR800

1. Because the MIDI clock and song position pointer will be output from the VR800, set the SETUP mode "MIDI sync signal output setting" to "cLK."

- * Initial setting: cLK
- * Permissible setting: cLK (MIDI clock and song position pointer:"CLK")
Mtc (MIDI time code: "MTC")
oFF (No output of MIDI sync signal)
- * This item can be setup for each program.
- * The setting can be saved/loaded as song data.
- * This setting will be held even though power is switched OFF.

Refer to page "95", SETUP mode "MIDI sync signal output setting" for correct operating procedures.

2. The meter in the desired bar can be set by "Time signature setting" of the SETUP mode.

- * Initial setting: 001 bar, 4/4 signature.
- * Permissible bar setting: 001~999
- * Permissible meter setting: 1/4, 2/4, 3/4, 4/4, 5/4, 1/8, 3/8, 5/8, 6/8, 7/8, 8/8, -- -- (Elimination of signature)
- * Permissible setting of maximum number of points: 64 points
- * This item can be set for each program.
- * The setting can be saved/loaded as song data.
- * This setting will be held even though power is switched OFF.

Refer to page "90", SETUP mode "Time Signature Setting" for operating procedure.

3. Tempo in the desired bar can be set by "Tempo setting" of the SETUP mode.

Tempo map is made in steps 2 and 3.

- * Initial setting: 001 bar, 1st meter, Tempo120.
- * Permissible bar setting: Follows the previous "Setup of the time signature."
- * Permissible signature setting: Follows the previous "Setup of the time signature."
- * Permissible setting of tempo: Quarter note=30~250 (Tempo elimination)
- * Permissible setting of maximum number of points: 64 points
- * This item can be set for each program.
- * The setting can be saved/loaded as song data.
- * This setting will be held even though power is switched OFF.

Refer to page "92", SETUP mode "Tempo Setting" for operating procedure.

4. Set the SETUP mode "Metronome setting" to ON if click sound is to be output according to the setup tempo map.

- * Initial setting: oFF
- * Permissible setup item: oFF, on
- * This item can be set for each program.
- * The setting cannot be saved/loaded as song data.
- * This setting will be held even though power is switched OFF.

Refer to page "93", SETUP mode "Metronome setting" for operating procedure.

5. Press the TIME BASE SEL key, and then change the time base display to BAR/BEAT/CLK.

Confirming the MIDI clock sync

During recording and at playback following the recording, the time base (BAR/BEAT/CLK) is displayed in accordance to the setup tempo map, and the MIDI clock and song position pointer is also output. Confirm that the travel position (BAR/BEAT/CLK) of the VR800 and the travel position of the synchronized MIDI sequencer are matched.

* If correct sync cannot be obtained, re-check the connections/cables and setting of both equipment.

Note: In the VR800, the "ABS 0" position is set at "-002BAR/1BEAT /00CLK (default setting value)."
 This setting is made in consideration of the time required (it will not sync immediately) for a MIDI sequencer, etc. to enter into sync. As a result, if the VR800 is played back from ABS 0 (LOCATE ABS 0), sync will be completed by the time it reaches the first bar, and will thus synchronize from the head of the tune. A BAR value of -002BAR/1BEAT/00CLK can be setup in the range of -009 ~ -002. Please refer to "Time signature setting" in SETUP mode for details.

Execution of recording

Various ways of recording can be conducted while synchronizing the VR800 and the MIDI sequencer with the MIDI clock.

MTC sync/MIDI machine control system

The following will explain synchronization by the MTC (MIDI time code) output and the computer controlling system using MMC (MIDI machine control). In this system, the VR800 will be the master and the computer (with sequence software) will be the slave. The VR800 will attach any desired offset (time difference) against ABS time (absolute time) and output it as MTC in any desired frame rate.

It can also carry out the proper operation upon receiving an MMC and Fostex System Exclusive Message from outside. In this case, because the VR800 can setup a DEVICE ID number by the SETUP mode "MIDI Device ID Setting" menu, a multiple number of VR800's can be separately controlled by changing the DEVICE ID numbers in the transmitted message from the computer. In regards to the corresponding content for MMC, refer to the "MMC list" on page "107" and on the Fostex System Exclusive Message, the "Fostex Exclusive List" on page "108."

- * Set VR800 in the initial state.
- * Confirm the program and sampling frequency of the digital mixer.

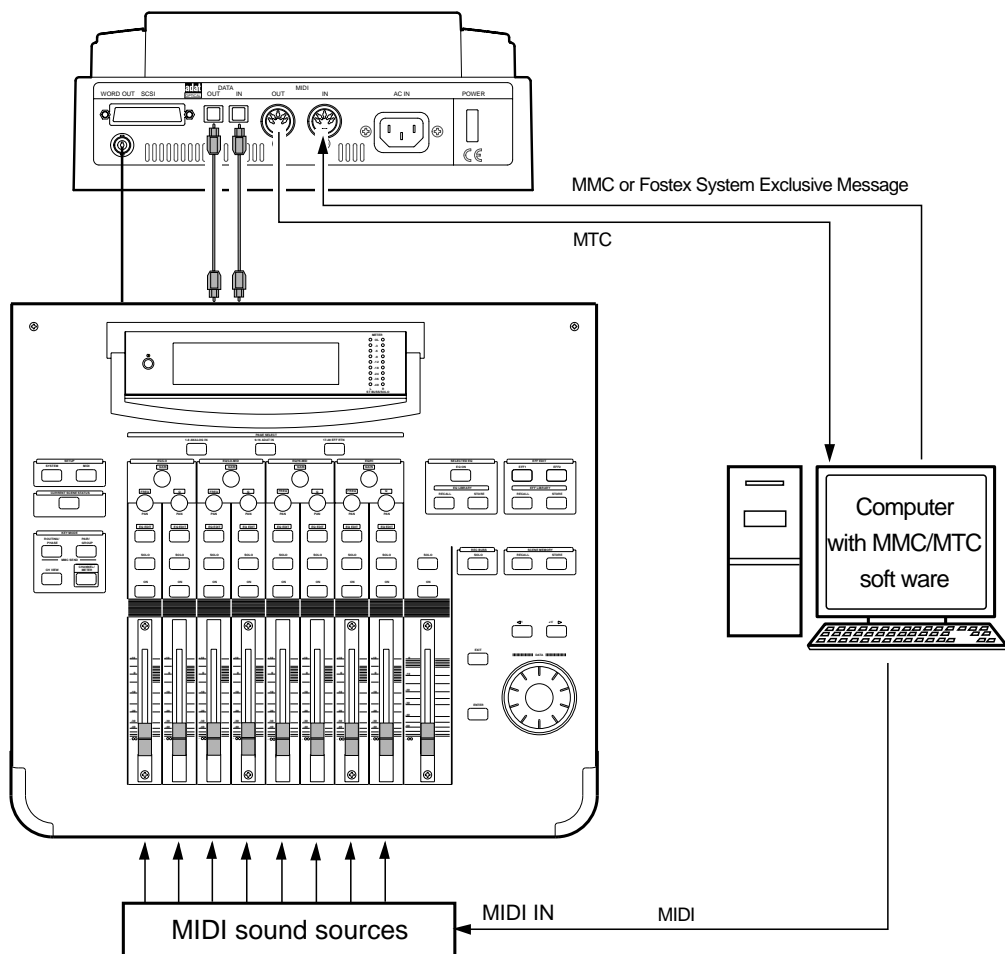

Connecting to external equipment

Connect the VR800 MIDI IN/OUT to the computer (with MIDI interface) MIDI IN/OUT (MMC/MTC complied sequence software is activated in the computer).

Setup of external equipment

Setup the following in the sequence software.

- * Set to MTC external sync mode (EXTERNAL SYNC).
- * Set for output of MMC.
- * Set to the desired MTC read out frame rate.
- * Set start time of the tune (which MTC time is to be the first bar). Refer to precaution in regards to MTC offset, farther on.

For details, refer to Owners Manual of the external equipment.

Setup of VR800

1. Because MTC will be output from VR800, set to "MTC" the SETUP mode "MIDI sync signal output setting."

Refer to page "95", SETUP mode "MIDI sync signal output setting" for operating procedure.

2. Set a random offset time by the SETUP mode "MTC offset time setting."

- * Initial setting: 00H (Hour) 59M (Minute) 57S (Second) 00F (Frame) 00SF (Sub Frame)
- * Permissible setup time: 00H 00M 00S 00F 00SF ~ 23H 59M 59S 29F 99SF
- * This item can be set for each program.
- * The setting can be saved/loaded as song data.
- * This setting will be held even though power is switched OFF.

Refer to page "96", SETUP mode "MTC offset time setting" for operating procedure.

3. In the SETUP mode "MTC offset mode setting," whether the MTC offset time setup in Step 2 should be output (ABS) at the ABS 00m 00s 00f 00sf position or at the 001BAR 1BEAT 00CLK (bar, signature) must be selected.

- * Initial setting: ABS
- * Permissible setup item: ABS, Bar 
- * This item can be setup for each program.
- * The setting can be saved/loaded as song data.
- * This setting will be held even though power is switched OFF.

Refer to page "97", SETUP mode "MTC offset mode setting" for operating procedure.

4. Setup to the same frame rate as that setup by the sequence software by "MTC Frame rate setting" of the SETUP mode.

- * Initial setting: 25 frames
- * Permissible setup of frame rate: 24, 25, 29.97nd, 29.97df, 30nd, 30df
- * This item can be setup for each program.
- * The setting can be saved/loaded as song data.
- * This setting will be held even though power is switched OFF.

Refer to page "96", SETUP mode "MTC Frame rate setting" for operating procedure and details.

5. Set to the same figure as the sequence software MMC device number (and Fostex System Exclusive Message device number) by the SETUP mode "MIDI device ID setting."

When the sequence software transmits by "7F," it means "ALL DEVICE" and therefore, it need not be setup.

- * Initial setting: 00
- * Permissible setup ID: 00 ~ 99
- * This item will be the setting common to all programs.
- * This setting cannot be saved/loaded as song data.
- * This setting will be held even though power is switched OFF.

Refer to page "104", SETUP mode "MIDI device ID setting" for operating procedure and details.

6. Press the TIME BASE SEL key to show time base in the MTC display.

<Notes on MTC related setups>

By "MTC offset time setting" and "MTC offset mode setting," at what position (ABS 0 or 001BAR/1BEAT/00CLK) should the setup MTC (MTC offset time) is to be output is set. When setting the start time of the tune in the sequence software by these setups, be careful of the following points.

* **Offset mode: For ABS**

If playback is started from ABS 0, since MTC will be output starting from the MTC offset time that has been set, the start time of the tune set by the sequence software must be set about 3 seconds later from the MTC offset time that was setup. This will provide time because the sequence software cannot sync immediately after MTC is output. For example, if the initial setting of 00H 59M 57S 00F 00SF" is used, set the start time of the tune to "01H 00M 00S 00F." If playback is thus started from ABS 0 (LOCATE ABS 0), sync will be obtained by the time it reaches the first bar and therefore it can be made to sync from the head of the tune.

* **Offset mode: For BAR/BEAT**

As mentioned before, because the "ABS 0" position is set at the "-002BAR / 1BEAT / 00CLK" (default value) position, the setup MTC offset time can be set to the head of the tune without taking into account the time until reaching sync, as mentioned above. The length of the time two bars beforehand will change in accordance to the first bar setting for "signature" and "tempo." For example, it will be long if the tempo is set slow. This mode can be effectively applied when using the MIDI clock and MTC in parallel, and when using MTC for the sync signal while controlling the VR800 with time base BAR/BEAT/CLK.

Confirming MTC sync/MMC

1. During recording and at playback after recording, time base MTC is displayed according to the setting and MTC is output at the same time.

Check that the VR800 traveling position (MTC) and the traveling position of the sequence software in sync are matched.

2. Send MMC commands such as PLAY, STOP and LOCATE from the sequence software to see that the VR800 will be properly controlled.

When a correct MIDI command (MMC or FEX) is received, "MIDI" in the display will be lit for about 40msec. There is no setting in the VR800 to receive MMC or FEX but it will operate if a correct MIDI signal is input.

* If sync and control cannot be done correctly, re-check connections/cables and the setting of both equipment.

Execution of recording

Carry out various recordings while synchronizing a VR800 and a MIDI sequencer with the MIDI clock.

External MIDI equipment sync system by the slave mode

Up to this point, synchronization with external MIDI equipment has been explained with the VR800 as the master and MIDI equipment as the slave but depending on the slave mode setting, the MIDI equipment can be set as the master and VR800 as the slave.

<Note>

External MIDI equipment which can be used as the master is limited to those which can output MTC.

* Initialize VR800.

* Confirm the program and sampling frequency.

* In the following, the explanation will be on the assumption that a computer (with sequence software) is used.

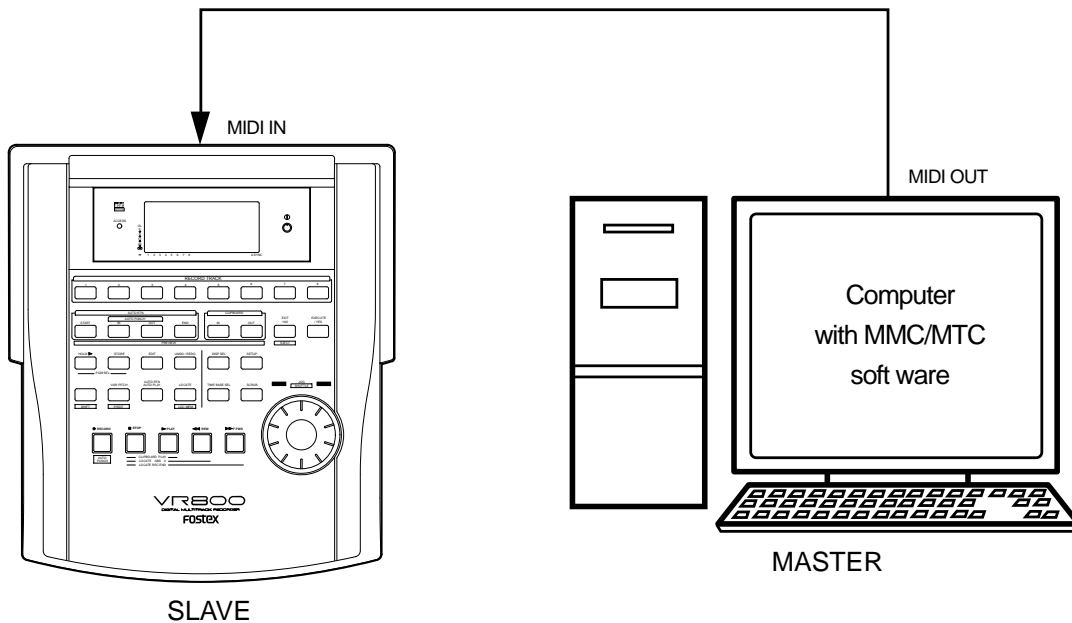

Connection to external equipment

Connect MIDI OUT of the computer (with MIDI interface) with MIDI IN of VR800. The computer sequence software complying to MMC/MTC must be activated.

Setup of external equipment

Sequence software is setup as follows.

- * Set for output of MTC.
- * Set frame rate of the MTC to be output.
- * Confirm start time of the tune.

Refer to Owners Manual of the respective equipment for details.

Setup of VR800

1. Set to same frame rate as the sequence software by the SETUP mode "MTC Frame rate setting."

Refer to page "96", SETUP mode "MTC Frame rate setting" for operating procedure and details.

2. Set to the desired mode by the SETUP mode "MTC offset mode setting."

Refer to page "97", SETUP mode "MTC offset mode setting" for operating procedure and details.

3. A random offset time can be set by the SETUP mode "MTC offset time setting."

Refer to page "96", SETUP mode "MTC offset time setting" for operating procedure and details.

4. Set slave mode to "On" by the SETUP mode "Slave mode setting," and the slave type to "Vari" by the SETUP mode "Slave mode type setting."

Refer to page "98", SETUP mode "Slave mode setting", and page "99", SETUP mode "Slave mode type setting", for operating procedure and details.

5. Press the TIME BASE SEL key to change the time base display to MTC.

<Precautions at MTC related setups>

The position (ABS 0 or 001BAR/1BEAT/00CLK) when the setup MTC (MTC offset time) should be output was setup by the "MTC offset time setting" and "MTC offset mode setting." In accordance to start time of the tune set by the sequence software, setup as explained below.

Offset mode: For ABS

Set the MTC offset time about three seconds prior to the start time of the tune set by the sequence software. Because the VR800 cannot immediately chase lock after input of MTC, in order to sync the VR800 from head of the tune, set the preroll using the sequence software, and playback from before the actual head of the tune to allow the VR800 to enter into sync by the time it arrives at the head of the tune.

Offset mode: For BAR/BEAT

The MTC offset time can be set to the same time as the start time of the tune set by the sequence software. Because the "ABS 0" position is set at the "-002BAR/1BEAT/00CLK" (default value) position in the VR800, as mentioned before, the preceding time required for sync is already set. The preceding time of two bar lengths could change in length depending on the first bar's "signature setting" and "tempo setting" mentioned before. For example, it will be longer if the tempo is slowed down.

Confirming chase lock

1. When the sequence software is played, "MTC" of the VR800 will light, "SLAVE" in the display will change from blinking to lit and the chase lock will be completed.

Check that the MTC output by the sequence software and MTC time displayed in the VR800 are the same.

2. When the sequence software stops, MTC will be interrupted and the VR800 will also stop.

"SLAVE" in the display will change from lit to blinking.

3. During FF/REW of the sequence software, VR800 will remain stopped but upon starting to record, the VR800 will immediately chase lock.

<Note>

Chase lock of the VR800 by MTC only is permissible when speed difference of the MTC from the master is within +/- 5.6%. Against the MTC within this range, variable pitch will be constantly applied internally for chasing. Chase lock, however, will not function against MTC at a speed difference outside this range. Also, when the master speed difference is large, it is advised to let VR800 learn the master speed by entering PLAY prior to recording. By doing so, it will be lock faster from the second and later sessions.

* Should it not be possible to chase lock, re-check connections / cables and all settings.

Execution of recording

Carry out various recordings while the VR800 is chase locked to the sequence software.

<One Point Advice>

Sync signal "Free" of the "Slave mode setting" menu:

When the VR800 is made to chase lock by MTC only, variable pitch will be constantly applied by external MTC. If a digital signal is output to an external digital equipment from the VR800, it will not be able to follow the speed difference (MTC speed difference of the master) of the VR800 and the external digital equipment, in some cases, may not be able to input a continuous digital signal.

As a counter measure, the sync signal should be set to "Free" by the "Slave mode setting" menu. Using this setting, the VR800 will enter self operation by the internal clock, after completion of chase lock, and it will be possible to supply a stable digital signal to the external equipment.

Under this setting, when MTC drift between the master unit and slave unit exceeds 10 frames, the VR800 will assume that chase lock has been disengaged and the slave unit will carry out position matching again with the master unit (re-chase operation). During the re-chase operation, sound output will be muted and the digital signal will also be interrupted. If it is within 10 frames, the slave unit will continue to run while admitting this drift.

Saving and Loading Song Data

Outline of the save/load operation

The VR800 has a Save/Load function for song data, which enables you to save the recorded song data (including SETUP data) to a connected backup media, such as a DAT machine, back-up SCSI disk or adat. You can also load the saved data from a DAT, back-up SCSI disk or adat to the current drive disk in the VR800. You can save and load one Program at a time to and from a DAT, adat, or SCSI drive.

The following diagram shows different methods (depending on the current drive type) for saving data to connected media, and how to load data to the VR800. Select the appropriate connections depending on the type of connected media.

Using a SCSI drive as the current drive:

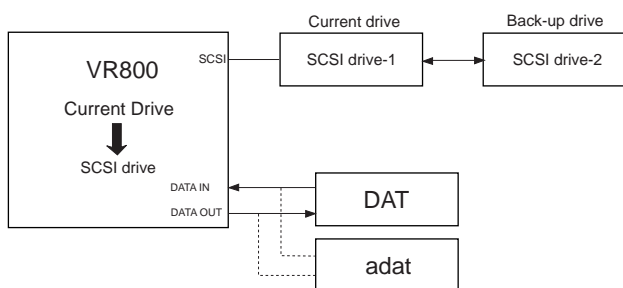

Note: You can save and load data between two SCSI drives, regardless of the recording mode used for the disks. When saving a multiple number of program data in one disk, they must definitely be of the same format.

Note: You can save and load data to and from a DAT or adat only if the current drive is a SCSI fixed disk and it has been formatted in Master 8ch mode. You cannot perform the save/load operation if the disk has been formatted in Master 4ch mode or ADAC 8ch mode. (However, only in the case of save/load by DAT, the master 4ch mode disk can also be used.)

The connection should follow one of these cases:

- * Transferring data between SCSI drive-1 and SCSI drive-2
- * Transferring data between SCSI drive-1 and a DAT (See "Note.")
- * Transferring data between SCSI drive-1 and an adat (See "Note.")

Note: Be sure to set the ID number for a backup SCSI drive to "6."

Using an 3.5-inch internal E-IDE hard disk as the current drive:

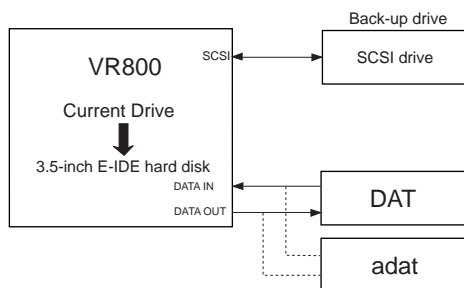

Note: You can save and load data to and from a DAT or adat only when the current drive has been formatted in Master 8ch mode. You cannot perform the save/load operation if the disk has been formatted in Master 4ch mode or ADAC 8ch mode. However, you can save and load data to and from a SCSI drive, regardless of the recording mode used for the disk.

Note: If you are using an 3.5-inch E-IDE hard disk as the current drive, you can connect only a SCSI backup disk to the SCSI terminal on the VR800 (the ID number should be set to "6."). If you connect a SCSI drive disk set up as a current drive disk (the ID is set to any number other than "6") and you turn on the power to the drive, the VR800 will recognize this SCSI drive as the current drive.

The connection should follow one of these cases:

- * Transferring data between a 3.5-inch E-IDE hard disk and a SCSI drive
- * Transferring data between a 3.5-inch E-IDE hard disk and a DAT (See "Note.")
- * Transferring data between a 3.5-inch E-IDE hard disk and an adat (See "Note.")

<Notes on connection>

If the connected DAT (preferably a professional model) features sync operation with external clock and its "INPUT (or EXTERNAL SYNC)" sync mode switch is set to OPTICAL, trying to load data with both digital I/Os connected as shown in the diagram may cause a digital clock loop to form and loading may fail.

In this case, set the sync mode of the DAT to INTERNAL, or disconnect the optical cable from the DATA OUT of the VR800 before loading data. This type of problem will not occur during the save operation since the DATA IN connector of the VR800 is not effective.

<Notes on DAT machines and the save and load operations>

You may use a DAT machine that can record digital data in S/P DIF format without compression in 16bit/44.1kHz mode. You cannot use media that uses a compression recording technique, such as an MD or DCC, media that automatically adjust the space between songs, such as a CD-R, media that converts sampling rate, or via Adat optical connectors. You can use media that features SCMS (Serial Copy Management System) if it satisfies the requirements described above. The following DAT models have been confirmed to operate with the VR800. Basically, any DAT machine that has digital in/out connectors in S/P DIF format will work for the save and load operation. However, some models (except those listed below) may cause errors.

Fostex: D-5, Pioneer: D-05

The save and load operations using a SCSI drive, DAT, or adat are described below:

*** Using a DAT (S/P DIF digital signal) (Saving/loading individual Program data: only in Master 8ch mode and Master 4ch mode)**

Following about five seconds of pilot signal (shown in gray in the diagram below), song data in the current drive is output to a connected DAT. Two tracks of audio data (shown in black in the diagram) are output. To save data from Real tracks 1-8, two-track data will be output four times, which takes twice as much time as the song duration (ABS 0 to REC END). To save all data including Additional tracks 9-24, two-track data will be output twelve times, which takes twelve times the song duration. Saved data is also loaded two tracks at a time.

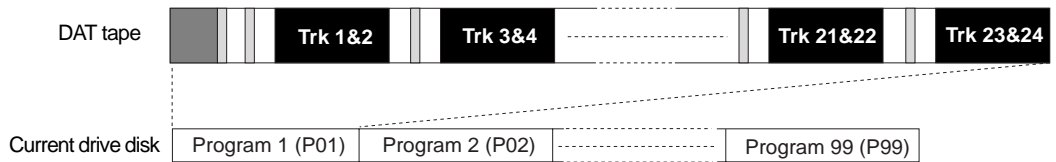

*** Using an adat (adat digital signal) (Saving/loading individual Program data: only in Master 8ch mode)**

After about five seconds of pilot signal (shown in gray in the diagram below), song data in the current drive is output to a connected adat. Eight-track audio data (shown in black in the diagram) is output. To save the data from Real tracks 1-8, data will be output once, which takes the same amount of time as the song duration (ABS 0 to REC END). To save all data including Additional tracks 9-24, eight-track data will be output three times, which takes three times the song duration. Saved data is also loaded eight tracks at a time.

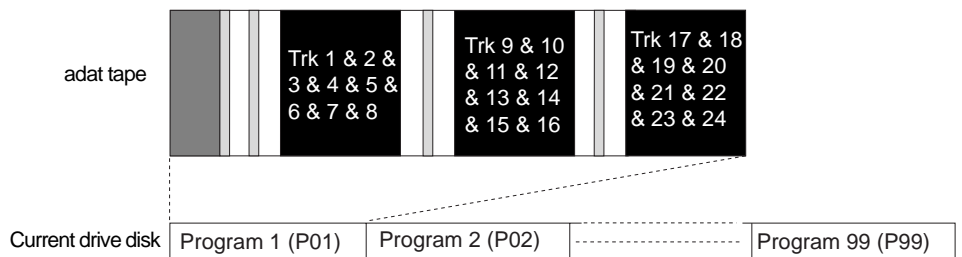

*** Using a SCSI disk (Saving/loading individual Program data: in any mode)**

All Real track data and Additional track data is output simultaneously to a SCSI disk as shown in black in the diagram. Therefore, saving and loading a Program takes much less time relative to a DAT or adat. No pilot signal or beep is recorded. If the available disk space is smaller than the song data size, you may use multiple disks (up to 99 disks) to save and load an entire song.

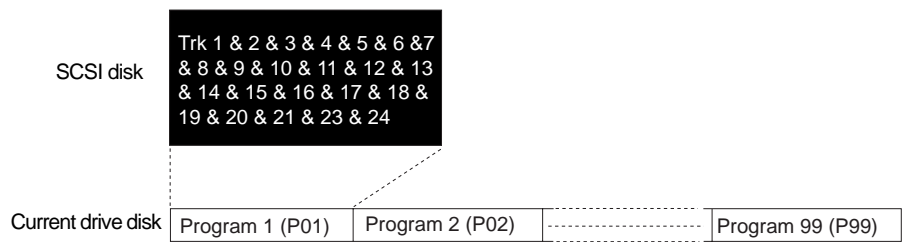

<Note when saving data using DAT or adat>

Refer to the following notes when you save all track data (real tracks and additional tracks) using a DAT or adat.

The duration of the data that can be saved on the disk is calculated based on the duration of the song data (ABS 0 - REC END) on the real tracks. Therefore, if you try to save data on an additional track that is longer in duration than the data on the real track, only that part of the additional track (up to the same time indication of the real track) will be saved.

For example, assume that you moved 10-minutes of data on a real track to an additional track (using the Track exchange function), then you recorded three minutes of data on the same real track. In this case, only three minutes of the additional track data will be saved. To reset (seven-minutes of data) will not be saved.

If this happens, set the save time longer (up to 59 minutes and 59 seconds) using the save time editing procedure (see Step 6 on page 83). Alternatively, move the longest data on the additional track to a real track, then perform the save operation. At this time, be careful not to accidentally erase important data on the additional tracks. Refer to the page 66 for more information on the Track Exchange function.

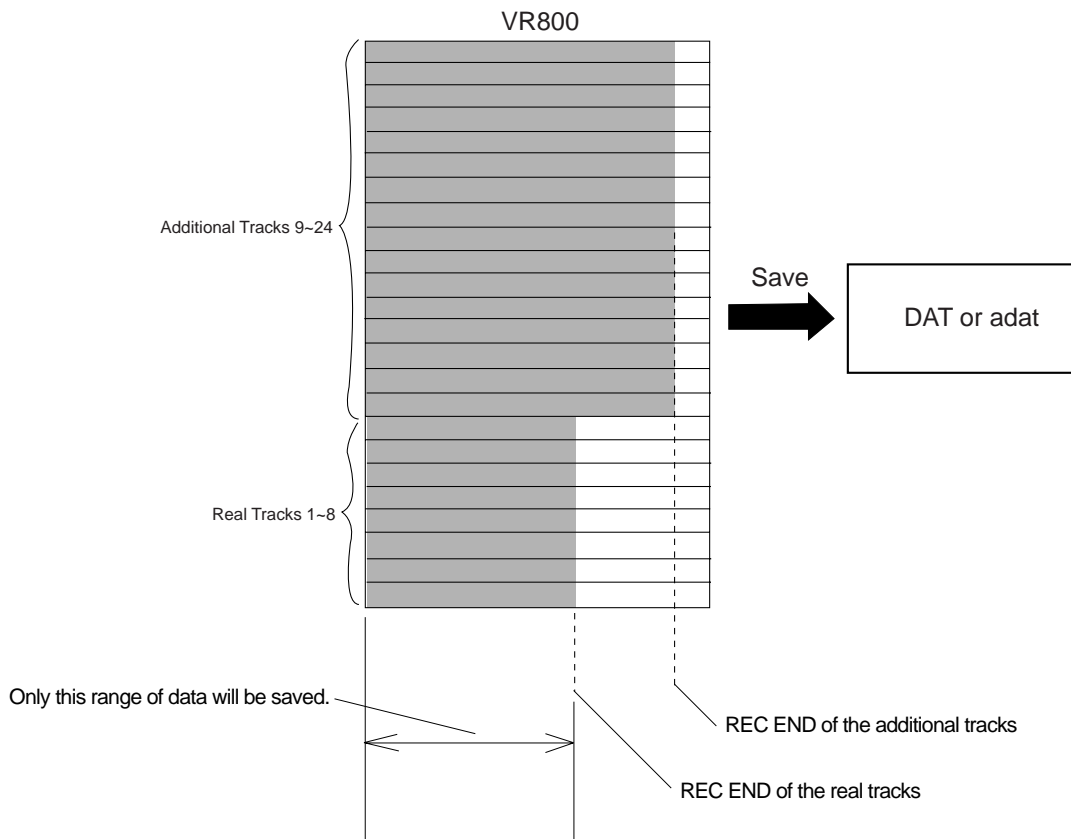

<Note when loading data using DAT or adat>

Although the VR800 digital-in clock may be set in its initial state of [ASYnC] (asynchronous mode), when loading from DAT or adat, the digital-in clock of the VR800 will temporarily operate in the same way as if it is in [SYnC] (synchronous mode). In this case, because it will operate even though the [ASYnC] setting indicator "●" is lit on the display, so care must be exercised not to create a digital clock loop.

<Note when saving/loading data using adat>

You may save data from the current drive to an adat as long as the current drive has been formatted in [Master 8ch] mode for eight-track simultaneous playback. You may also load data from an adat to the current drive if the drive was formatted in [Master 8ch] mode to enable 8-track simultaneous recording via the adat interface. Fostex will not guarantee operation of the VR800 if you use drives in other modes.

*** The following items can be saved and loaded as song data:**

Memory data (CLIPBOARD IN/OUT, AUTO RTN START/END, AUTO PUNCH IN/OUT points)
 Time base (ABS, MTC, or BAR/BEAT/CLK)

SETUP mode: * Time signature setting (BAR BEAT), * Tempo setting, * Preroll time setting, * MIDI sync out setting,
 * MTC frame rate setting, * MTC offset time setting, * MTC offset mode setting, * Rec protect On/Off setting,
 * Slave mode On/Off setting, * Slave type setting

*** The following items cannot be saved and loaded as song data:**

Auto Play mode and Auto Return mode On/Off setting
 Vari-pitch mode On/Off setting, and Pitch data

SETUP mode: * Digital In setting, * Digital Out setting, * Bar/Beat Resolution On/Off setting, * Device ID setting * Click On/Off setting,

Saving and loading data using a SCSI drive as the current drive

If the current drive is a SCSI drive (removable disk or fixed disk), you can save and load data to and from a backup SCSI drive, DAT, or adat. If the backup drive is a SCSI drive, save and load operations are not limited by the type of recording mode used for the current drive. If you are using a DAT or adat as a backup drive and using a fixed disk as the current drive, the fixed current drive should be formatted in "Master 8ch mode" to enable saving and loading. However, only in the case of save/load by DAT, the "Master 4ch mode" disk can also be used.

Saving/loading data using another SCSI drive

This section explains how to save and load data to and from a removable current SCSI drive and a backup SCSI drive. Turn off the power to all connected devices before you make connections.

Note: Unlike the save/load operation using a DAT or adat, you cannot abort the save/load operation that uses a SCSI drive. Nor can you monitor audio data during the operation. Also, you cannot load data to a disk formatted in a recording mode that differs from that on the backup disk. For example, you cannot load data from a backup disk in ADAC 8ch mode to a disk in Master 8ch mode.

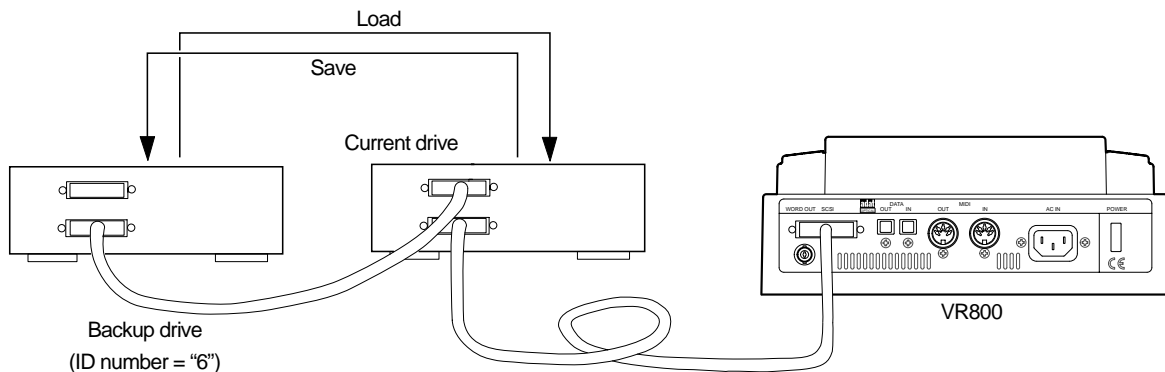

SCSI drive connection and preparation

- * Connect your backup SCSI drive to the SCSI connector on the current SCSI drive. Be sure to attach a terminator on the second SCSI drive to terminate the SCSI chain.
- * Be sure to set the ID number for the backup SCSI drive to "6."
- * Prepare the disk recorded as the current drive and a backup disk (unformatted disk).

<Title of data to be saved to a backup SCSI disk>

Data recorded in the current drive has a name, such as Program 1 or Program 2. (These titles appear abbreviated, such as [P01], [P02]).

On the other hand, a backup disk manages data using different titles, such as Backup 1 or Backup 2. (These appear abbreviated, such as [B01] or [B02] on the display.)

For example, Program 1 (P01) on the current drive disk is saved as Backup 1 (B01) for the backup disk.

Saving data

* You can back up data using the "Save PGM?" menu in SETUP mode. The following procedure assumes that a recorded disk has been inserted in the current SCSI drive, Program 1 (P01) has been selected, and an unformatted disk will be used as the backup disk.

<[Save PGM ?] menu>

- * Output signal options: [AdAt], [dAT], [SCSi id-6]
- * Program options: P01 - P99 (an individual Program)
- * Track options: When using an adat or DAT: tracks 1-8, tracks 1-16, Tracks 1-24; When using a SCSI disk: All tracks will be automatically selected.

1. Insert an unformatted disk into the backup drive.
2. Press the SETUP key to enter SETUP mode, then use the JOG dial to select [Save PGM ?] menu.
3. Press the EXECUTE/YES key.

[Device ?] appears and the selected output signal option flashes. ([SCSi id-6] flashes.)

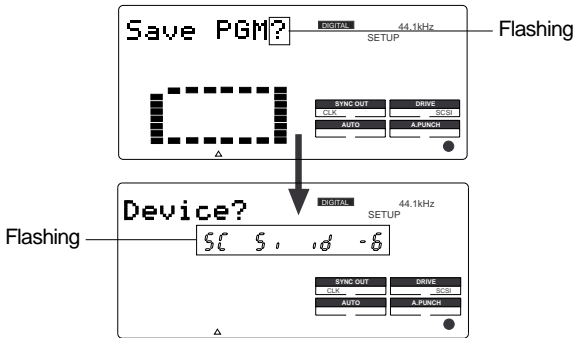

Normally, the initially displayed save device will be the flashing [SCSi id-6] as shown above. At this stage, if the JOG dial is rotated, besides the flashing [SCSi id-6], [dAT] or [AdAt] can be selected. [dAT] or [AdAt] is selected if either DAT or adat are used for saving.

4. Press the EXECUTE/YES key. The VR800 recognizes that a disk in the backup drive is unformatted, and displays [Unformat?], then proceeds to the [Bk Format?] menu (backup disk format) in SETUP mode, then displays the following.

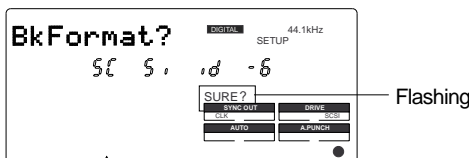

5. Press and hold down the RECORD button, and press the EXECUTE/YES key. The VR800 displays the following and starts formatting the disk. The unformatted disk area size will count down as the format operation progresses.

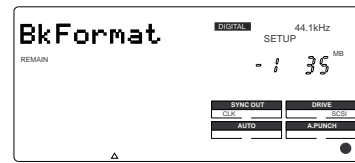

When the formatting operation is completed, [COMPLETED!] lights up, [SCSi id-6] flashes, then the VR800 displays the following.

This example shows that the data to be saved is Program 1 on the current drive. If the current drive has multiple Programs, use the JOG dial to select the desired Program.

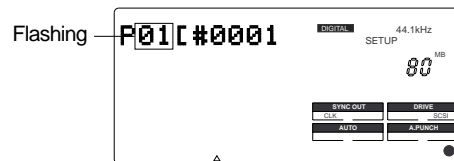

5. Use the JOG dial to select the desired Program and press the EXECUTE/YES key.

The save operation starts and the following indication appears.

This example shows that Program 1 data is being saved as Backup data 1. As the save operation progresses, the REMAIN value (e.g.: -80MB) counts down.

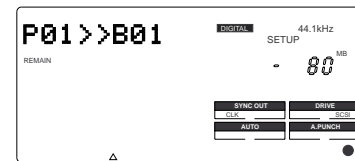

When the save operation is completed, [COMPLETED!] lights up and the following indication appears.

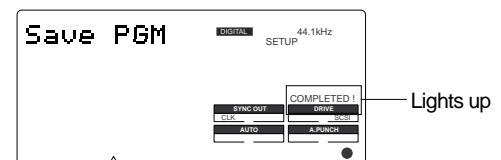

8. Press the EXIT/NO key to exit SETUP mode. The VR800 displays ABS 0 of the Program on the current drive.

Note: The backup data will use the number of the saved Program. (e.g., if you save P01 [#0001] data, the backup data will be named as B01[#0001].) You cannot edit the title of the backup data.

The above procedure assumes that the saved data size is smaller than the available space of the backup disk. You can use only one backup disk. To save data larger than a single backup disk, refer to the next <Memo> for information on saving data using multiple backup disks.

<Memo>

If Program data to be saved is larger than the space available on one backup disk, the VR800 tells you how many backup disks you need when you select a Program in Step 6 of the previous procedure.

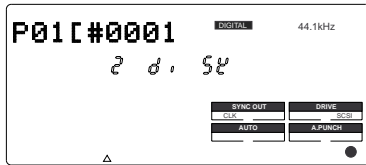

(e.g.)
Two backup disks are required.

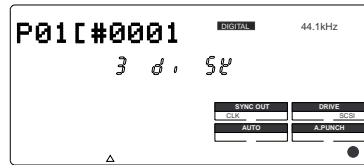

(e.g.)
Three backup disks are required.

When you set the first disk, the save operation starts. When the disk is full, the VR800 automatically ejects the disk and displays [Ins. Disk 2] (meaning "Please set the second disk.").

Set the second disk to continue the save operation.

Note: Mark the disks so that you can identify the order of the disks and you will be able to insert the disks in the correct order to perform the load operation.

Loading data

- * You can load data using the "Load PGM ?" menu in SETUP mode. The following procedure assumes that the backup disk has been inserted into the backup SCSI drive, and a formatted disk has been inserted into the current drive.

<[Load PGM ?] menu>

- * Input signal options: [AdAt], [dAT], [SCSi id-6]
- * Program options: P01 - P99 (an individual Program)
- * Track options: When using an adat or DAT: tracks 1-8, tracks 1-16, Tracks 1-24;
When using a SCSI disk: All tracks will be automatically selected.

1. Press the **SETUP** key to enter **SETUP** mode, then use the **JOG** dial to select **[Load PGM ?]** menu.

2. Press the **EXECUTE/YES** key.

[Device ?] appears, and the selected input signal option flashes. ([SCSi id-6] flashes.)

Normally, the initially displayed load device is the flashing [SCSi id-6]. At this stage, if the JOG dial is rotated, in addition to the flashing [SCSi id-6], [dAT] or [AdAt] can be selected.

[dAT] or [AdAt] is selected when DAT or adat is used for loading.

4. Select a flashing **[SCSi id-6]** and press the **EXECUTE/YES** key.

The saved backup number (01) flashes. This means that B01 on the backup disk is selected to load.

If only this backup file exists on the disk, turning the JOG dial will allow you to select [B01] or [Eject].

Select [Eject] if you wish to change the disk.

If there are multiple backup files on the disk, using the JOG dial allows you to select the desired backup data (B01, B02, B03, etc.) or [Eject].

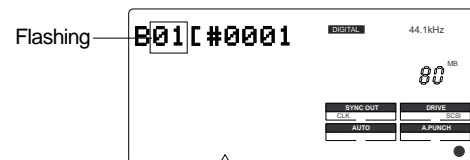

5. Press the **EXECUTE/YES** key.

The VR800 indicates that the load destination disk (current drive disk) does not have any data, then indicates a flashing [SURE?].

At this time, using the JOG dial allows you to select the load destination Program.

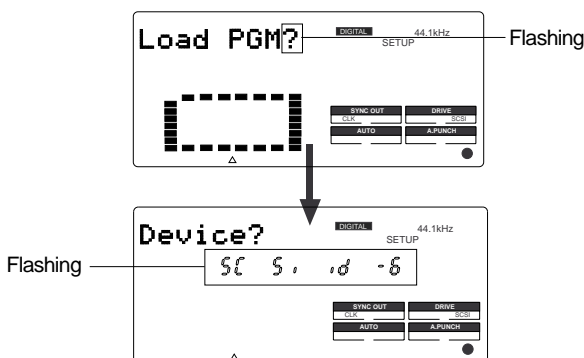
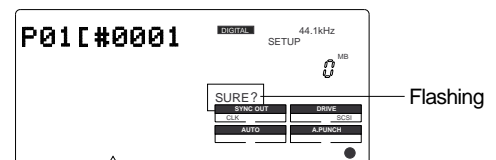

Since there is only one Program in the destination disk in this example, you can select only [P01].
 If the destination disk contains multiple Programs, see the following <Memo>.

6. Use the JOG dial to select the load destination Program and press the EXECUTE/YES key.

The VR800 starts loading data.
 Backup data [B01] is loaded to Program [P01] on the current disk. As the operation progresses, the REMAIN value counts down.
 When the load operation is completed, [COMPLETED !] lights up.

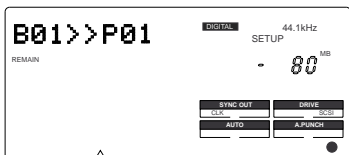

7. Press the EXIT/NO key to exit SETUP mode.

The Time Base display of the loaded Program appears.

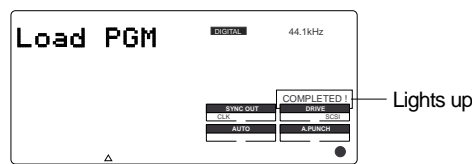

8. Press the EJECT button on the backup drive to eject the backup disk.

<Memo>

If you saved one Program to multiple backup disks, the VR800 indicates that the disk in the drive is the "first" disk, as follows:

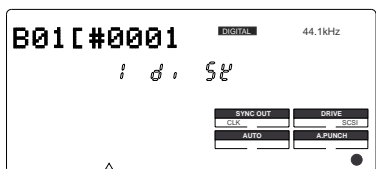

Confirm that this message appears, and execute the load operation. When data in the first disk is loaded, the VR800 automatically ejects the disk and displays [Inst. Disk 2], meaning "Please insert the second disk." Insert the second disk and continue the load operation.

Note: Make sure that you insert the disks in the correct order. If you insert the wrong disk, the VR800 displays [Wrong disk] and ejects the disk. Follow the disk markings you made during the save operation.

<Memo>

If the load destination disk contains multiple Programs, the VR800 asks whether you wish to set up a new Program in Step 6 of the procedure above. ([03] and [SURE ?] flash.) This is because the existing Programs may already contain data. If you do not mind overwriting the existing data with the loaded data, select the desired Program number as the load destination.

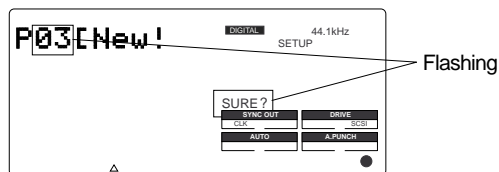

In the above display example, the VR800 asks you if you wish to create a new Program 3, since Programs 1 and 2 on the current drive disk contain data.

Saving/loading via a DAT or adat

To use a DAT or adat to save and load data, the current SCSI drive disk should be a fixed disk that is formatted in "Master 8ch mode." However, save/load only when using DAT is possible, and can also be used for the "Master 4ch mode disk."

Refer to the "Saving/loading data using an 3.5-inch E-IDE hard disk as the current drive" section for a detailed procedure of the save/load operation.

Saving/loading data using an 3.5-inch E-IDE hard disk as the current drive

If you are using an 3.5-inch E-IDE hard disk as the current drive, you can save and load data to and from a DAT, adat, or backup SCSI drive disk.

<Note on the save/load operation using an 3.5-inch E-IDE hard disk>

Before saving or loading data to/from the connected 3.5-inch E-IDE hard disk, make sure that the [IDE] indicator is lit in the current drive section of the display. If a SCSI drive is also connected to the VR800 as the current drive, disconnect the SCSI drive, or turn off the SCSI drive, then turn on the VR800.

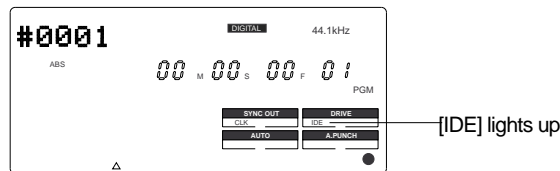

Saving song data via a DAT or adat

This section explains how to save data from an 3.5-inch E-IDE hard disk (current drive) to a DAT or adat. You can simultaneously save two tracks of data from an individual Program to a DAT, or eight tracks to an adat. Be sure to turn off the power to the all devices before you make connections.

Note: The current drive disk should be formatted in "Master 8ch mode" to enable you to save data to a DAT or adat. However, only the "Master 4ch mode" disk can be saved/loaded when using DAT.

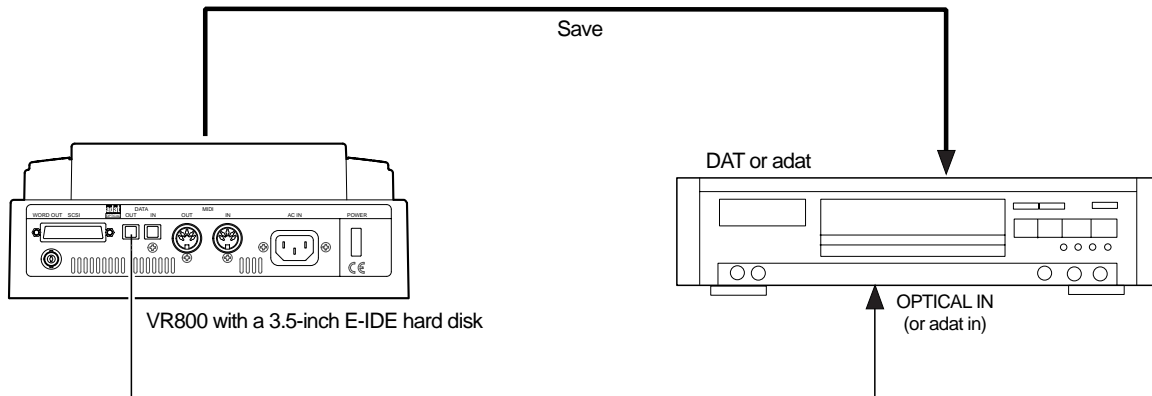

DAT (or adat) connection and preparation

- * Connect DATA OUT from the VR800 to the OPTICAL IN on a DAT, or to adat in on an adat using an optical cable. If you are using S/P DIF digital signal (DAT), use an optional Fostex COP-1 (optical-coaxial converter) to connect a DAT that is equipped with only a COAXIAL (RCA) digital input.
- * After all connections have been made, turn on the power to all devices, and insert a tape into a DAT (or adat). Make sure that the tape's "write-protect tab" is closed so that it can be recorded, and that the tape is rewound to the beginning.
- * Set the sampling frequency of a DAT (or adat) to the same value as the VR800 (44.1kHz).

- * Set the DAT or adat so that it will accept S/P DIF digital input (or adat digital input). Some models may have to be set so that they will synchronize with the incoming digital signal. Refer to the manual that came with your DAT or adat for more information.

Note: Depending on whether you use a DAT or an adat, you need to switch between S/P DIF digital signal (OPTICAL) and adat digital signal for the DATA IN/OUT jacks. These signals are completely different, although they use the same jack configuration.

Saving data

* You can back up data using the "Save PGM ?" menu in SETUP mode.

The following procedure assumes that Program 1 on the 3.5-inch E-IDE hard disk (current drive) contains performance data.

<[Save PGM ?] menu>

- * Output signal options: [AdAt], [dAT], [SCSi id-6]
- * Program options: P01 - P99 (an individual Program)
- * Track options: When using an adat or DAT: tracks 1-8, tracks 1-16, Tracks 1-24;
When using a SCSI disk (SCSi id-6): All tracks will be automatically selected.

1. Press the **SETUP** key to enter **SETUP** mode.

2. Use the **JOG** dial to select **[Save PGM ?]** menu, then press the **EXECUTE/YES** key.

[Device ?] appears and the selected output signal option flashes. ([SCSi id-6] flashes.)

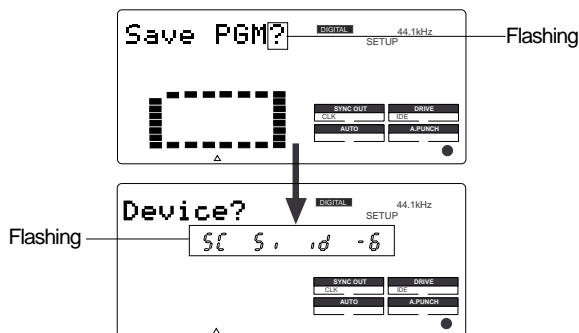

3. Use the **JOG** dial to select the desired digital signal for the save operation ([dAT] or [AdAt]).

[AdAt]	Select this to save data in the adat digital signal format to a connected adat.
[dAT]	Select this to save data in the S/P DIF digital signal format to a connected DAT.

4. Press the **EXECUTE/YES** key.

The number of the Program selected before the VR800 entered SETUP mode flashes on the display, indicating that you can select a Program to save.

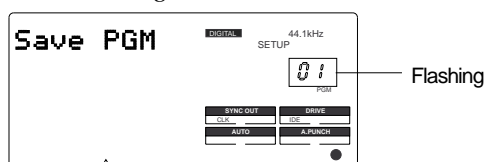

5. Use the **JOG** dial to select a Program to save.

If multiple Programs exists in the current drive disk, turn the **JOG** dial to change the Program number.

6. Press the **EXECUTE/YES** key.

The total time saved in the selected program will be shown in the display, and this time can then be edited.

Normally, the displayed time is saved as it is. But, as mentioned in <Notes when saving data using DAT or adat> on page 77, in cases where the data on the additional track is longer than that on the real track, the time to be saved can be edited. However, time which can be edited has to be a maximum 59 minutes 59 seconds. This feature is also effective for making a short save.

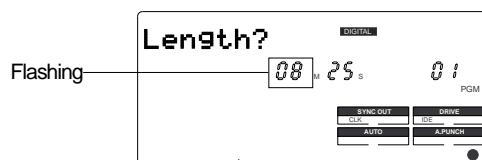

To edit the time value, use the **HOLD/>** key, **REWIND** button, or **F FWD** button to move the flashing cursor to the desired digit, and turn the **JOG** dial to change the value. (The above example shows you can edit the minute value.)

7. Press the **EXECUTE/YES** key.

The VR800 displays the track selection screen.

First, Real tracks 1-8 appear. Turn the **JOG** dial to change number "8" to the desired number.

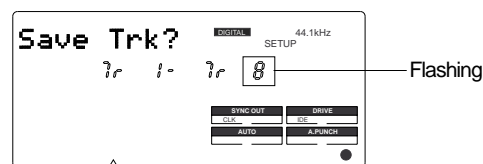

8. Use the **JOG** dial to select the desired tracks.

Options are Tr 1-8, Tr 1-16 (Real track 1-8 and Additional track 9-16), or Tr 1-24 (Real track 1-8 and Additional track 9-24).

9. Press the **EXECUTE/YES** key.

The display changes as follows.

This means "Start recording on the DAT (or adat)!"



10. Start recording on the DAT (or adat).

At this time you could set a **START-ID** or a locate point at the recording start point so that you will be able to find the top of the Program to load later.

11. Press the **EXECUTE/YES** key.

The VR800 starts saving data and displays the total time required for the save operation. The time value starts counting down a few seconds later.

Before the value starts counting down, the VR800 is transmitting a pilot signal that will be a reference of the tape position during the load operation. Actual data recording starts when the count down starts.

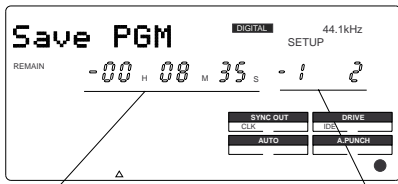

This value represents the total duration of the Program being saved, and counts down as the save operation progresses.

This area shows which tracks are currently being saved. During the save operation to the DAT, it indicates tracks 1-2, then changes to 3-4, 5-6, etc. in two-track steps. During the save operation to adat, it indicates tracks 1-8, then 9-16, and 17-24, according to the track selection in Step 8.

A DAT records two tracks at a time. An adat records eight tracks at a time. Level meters 1 and 2 indicate the level of signal output to a DAT. Level meters 1-8 indicate the level of signal output to an adat. When the save operation is completed, [COMPLETED !] lights up and the VR800 stops. Stop recording on the DAT (or adat).

12. Press the EXIT/NO key or the STOP button.

The VR800 exits SETUP mode and [COMPLETED !] disappears. The VR800 displays the Time Base (ABS 00M 00S 00F) of the saved Program.

Loading song data via a DAT or adat

This section explains how to load backup data from a DAT or adat to a 3.5-inch E-IDE hard disk (current drive). You can load two-tracks of individual Program data from the DAT simultaneously, or eight tracks of data from the adat.

This procedure assumes that no recordings exist on the current drive (load destination). Be sure to turn off the power to all devices before you make connections.

Note: The current drive disk should be formatted in "Master 8ch mode" to load data to or from a DAT or adat. However, loading from DAT only is also possible in the "Master 4ch mode" disk.

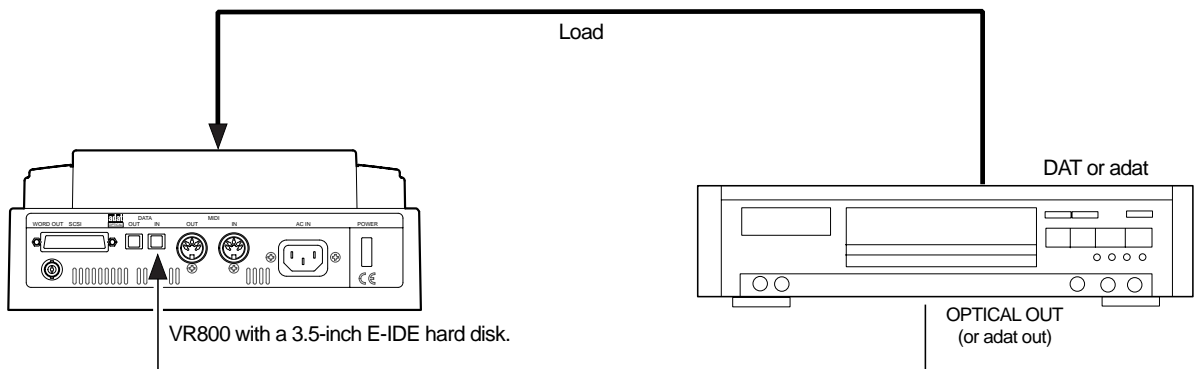

DAT (or adat) connection and preparation

- * Connect the DATA IN on the VR800 to the OPTICAL OUT on a DAT or to "adat out" on an adat using an optical cable. If you are using S/P DIF digital signal (DAT), use an optional Fostex COP-1 (optical-coaxial converter) to connect a DAT that is equipped only with a COAXIAL (RCA) digital output.
- * After all connections are made, turn on the power to all devices, and insert a backup tape into a DAT (or adat). Rewind the tape to a point slightly before the beginning of the saved data.

Note: Depending on whether you use a DAT or an adat, you need to switch between S/P DIF digital signal (OPTICAL) and adat digital signal for the DATA IN/OUT jacks. These signals are completely different, although they use the same jack configuration.

Loading data

* You can load data using the "Load PGM ?" menu in SETUP mode. The following procedure assumes that the current drive disk (3.5-inch E-IDE hard disk) does not contain any recordings, and that Program 1 (P01) has been set up on the disk.

<[Load PGM ?] menu>

- * Input signal options: [AdAt], [dAT], [SCSi id-6]
- * Program options: P01 - P99 (an individual Program)
- * Track options: When using an adat or DAT: tracks 1-8, tracks 1-16, Tracks 1-24;
When using a SCSI disk (SCSi id-6): All tracks will be automatically selected.

1. Press the **SETUP** key to enter **SETUP** mode.

2. Use the **JOG** dial to select **[Load PGM ?]** menu, then press the **EXECUTE/YES** key.

[Device ?] appears and the selected input signal option flashes. ([SCSi id-6] flashes.)

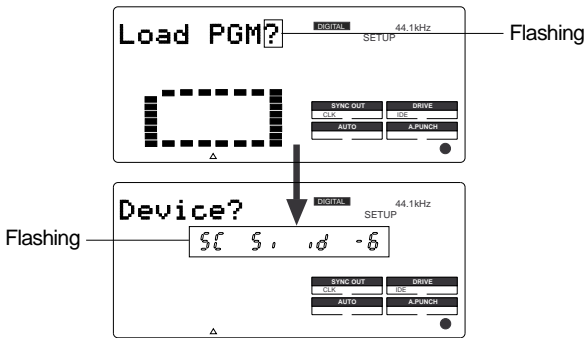

3. Use the **JOG** dial to select the desired type of digital signal used for the load operation ([dAT] or [AdAt]).

[AdAt]	Select this to load data in the adat digital signal format from a connected adat.
[dAT]	Select this to save data in the S/P DIF digital signal format from a connected DAT.

4. Press the **EXECUTE/YES** key.

The number of the Program set up on the current drive flashes on the display.

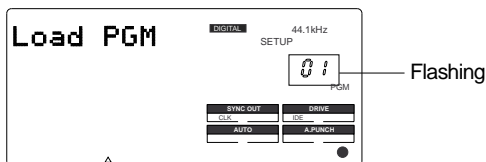

5. Use the **JOG** dial to select a Program into which to load data.

If only one Program has been set up, turning the JOG dial enables you to select [01] or [02]. If you select [02], "PGM" of [Load PGM] and [New] flash alternately. This means that a new Program (P02) should be set up before you execute the load operation. (If multiple Programs exist in the current drive disk, turn the JOG dial to select a Program from these Programs plus one new Program.)

6. Press the **EXECUTE/YES** key.

The VR800 displays the track selection screen. You can change the value of a flashing number.

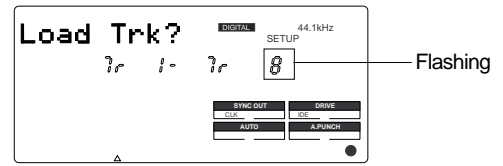

7. Use the **JOG** dial to select the desired tracks.

Options are Tr 1-8, Tr 1-16 (Real track 1-8 and Additional track 9-16), or Tr 1-24 (Real track 1-8 and Additional track 9-24). In this example, select Tr 1-8.

8. Press the **EXECUTE/YES** key.

The VR800 enters "load standby" mode and displays the following. [SURE ?] flashes.

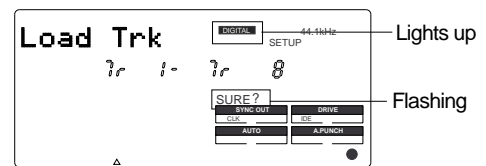

Flashing [DIGITAL] indicates that signal is not input from the digital device (DAT or adat) correctly. Check the connections.

Note: Although the [ASYnC] (Asynchronous mode) indicator ● may be lit in the display, during loading, the VR800 will operate in the [SYnC] (Synchronous mode). Be careful of making a digital loop which can be created by the digital in clock.

9. Make sure that **[DIGITAL]** lights up steadily, and press the **EXECUTE/YES** key.

The VR800 displays the following, indicating "Start playing the DAT!" If you are using an adat, [Play AdAt] flashes.



10. Start playing the DAT (or adat).

Start playing the tape from a point slightly prior to the top of the Program data. The VR800 reads the recorded pilot signal, then automatically starts loading data. (Wait a while until the following indication appears.)

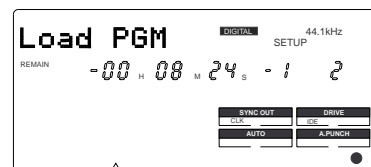

The VR800 displays the track numbers being loaded and the total time of the Program. The time value starts counting down as the load operation progresses. The RECORD TRACK select key lamps for tracks 1 and 2 flash, and level meters 1 and 2 indicate the level of signal input from the DAT. (All RECORD TRACK select lamps flash and level meters 1-8 indicate the level of signal input from an adat.)

When the load operation is completed, [COMPLETED !] lights up. The VR800 displays the top of the Program in the current drive and stops.

11. Stop playing the DAT (or adat).

12. Press the EXIT/NO key or the STOP button.

[COMPLETED !] disappears.

Saving and loading song data via a SCSI drive

This section explains how to save and load data to and from a SCSI backup drive and a 3.5-inch E-IDE hard disk. Recording mode on the current drive does not affect this operation. Refer to the "Saving and loading song data between two SCSI drives" for more information on the procedure.

Connect a SCSI backup drive (ID #=6) to the SCSI connector on the 3.5-inch hard disk in the VR800, as shown below.

<Note on connections>

Be sure to connect a SCSI backup drive to the SCSI connector. Make sure that the ID number for the SCSI backup drive is set to "6."

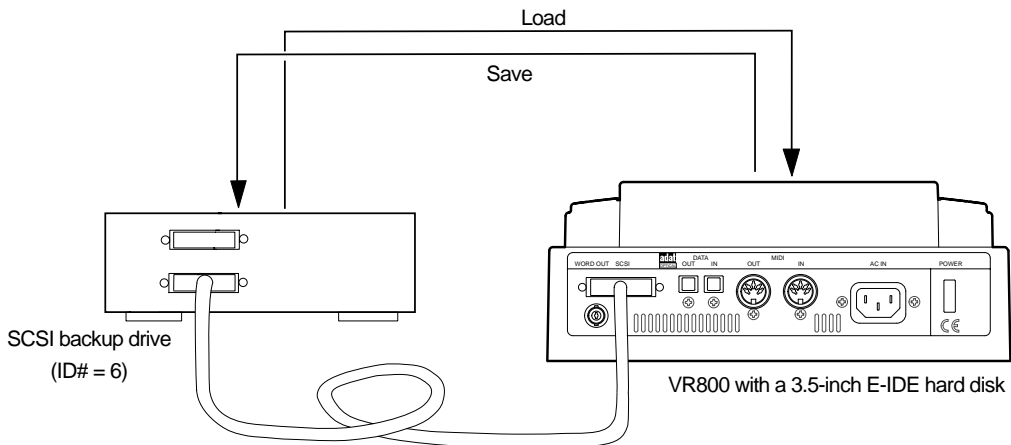

Note: As shown in the drawing, when the SCSI drive assigned for the current drive is daisy chained to the SCSI drive for backup and also connected to an 3.5-inch E-IDE hard disk which is in the current drive mode, please note the following items.

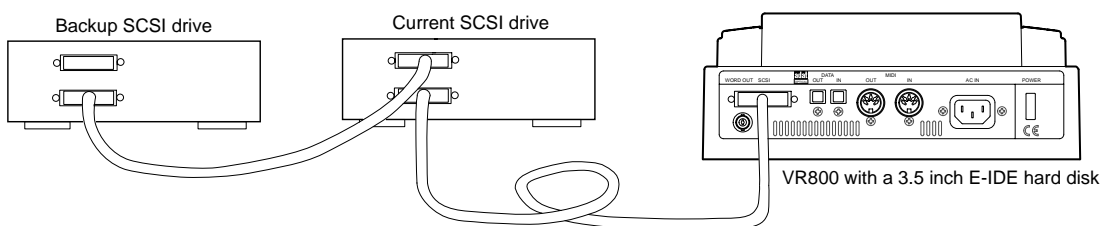

When the 3.5-inch E-IDE hard disk is assigned as the current drive:

Switch on power to VR800 only and not to the two SCSI drives connected.

If save/load of song data is to be executed using the SCSI drive assigned for backup, switch on power to the VR800 and the SCSI drive assigned for backup. Do not switch on power to the SCSI drive assigned for the current drive. By utilizing either method, VR800 will always recognize the 3.5-inch E-IDE hard disk as the current drive.

In order to use the SCSI drive as the current drive, power to any equipment that is interconnected must, of course, be switched on. The SCSI drive will automatically switch to the current drive mode.

<Quick Troubleshooting>

If you are stuck in one of the following situations, refer to the explanations below for corrective actions.

The VR800 displays the following during the save operation using a SCSI backup drive:

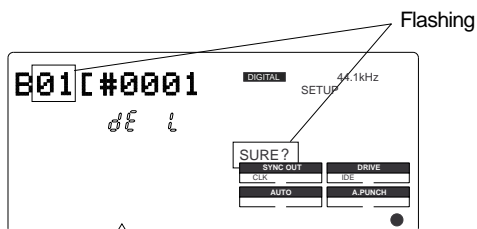

The backup disk contains some data and does not have enough free space to record new data. The VR800 is asking you whether or not the existing data should be deleted. Take one of the following actions:

*** If you wish to delete the existing data:**

Press the EXECUTE/YES key twice. Pressing the key once causes [Del. ALL ?] and [SURE ?] to flash, and pressing it again deletes the existing data so that you will be able to continue the save operation.

*** If you do not wish to delete the existing data:**

Turn the JOG dial to display [Eject], then press the EXECUTE/YES key. The disk will be ejected. Insert another backup disk in the drive.

When you inserted a SCSI backup disk into the backup drive to save data, the following messages appeared in turn and the disk was ejected.

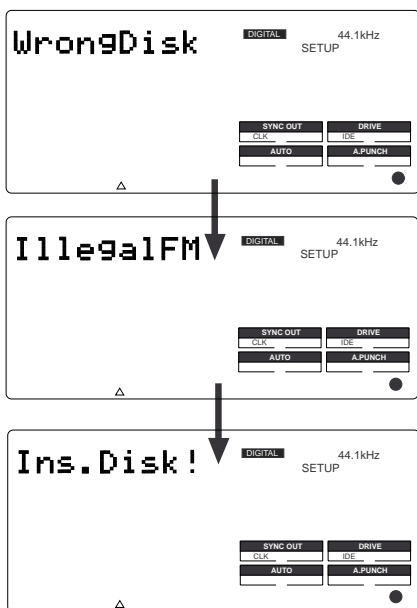

The VR800 recognizes that the backup disk cannot be used in its current condition. There are two reasons for this.

*** You inserted a disk that was used for the current drive.**

*** The disk's recording mode differs from that of the data to save or load.**

For example, the disk used to save or load data in Master 8ch mode is inserted to save data in ADAC 8ch mode. That is, you tried to use a disk (that was once used to save or load data in a particular recording mode) to save data in a different recording mode.

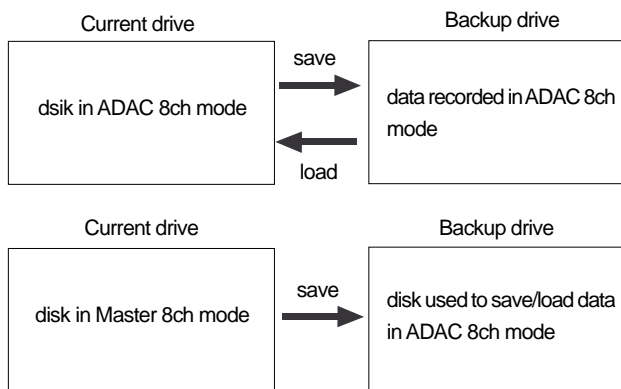

To be able to use the ejected disk, you need to re-format it as described below.

*** Quit SETUP mode and return to the Time Base display of the current disk, then insert the disk in the backup drive.**

*** Select the [Bk Format ?] menu in SETUP mode and re-format the backup disk.**

Note: When saving a multiple number of program data to one disk, they must be in the same format. Should data of different format be mixed and saved, the situation above will occur.

Changing the Initial Settings (SETUP Mode)

SETUP mode of the VR800 offers the “Changing the initial settings” menus that configure the operating environment of the VR800, a “Check” menu that enables you to check the number of events of each track, and the “Execution” menus that execute certain operations, such as save and load.

The “Changing the initial settings” menus include 15 parameters as shown in Table-1 below. These parameters were set before the unit was shipped from the factory (These values are called the “initial settings.”). Modifying these settings allows you to change the operating environment of the VR800.

The “Check” menu provides one parameter “Checking the number of events” as shown in Table-2.

Also, as shown in Table-3, the “Execution” menus include six items: Title Edit?, Delete. PGM?, Load PGM?, Save PGM?, and Disk Format?, which you can execute by selecting the corresponding SETUP menu. This chapter explains how to use the “Changing the initial settings” menu shown in Table-1 and the “Check” menu shown in Table-2. For more information on the “Execution” menus, refer to the corresponding pages in the “Reference page” column in Table-3.

<Table-1> “Changing the initial settings” menu

Parameters	Display	Default setting	Refer page	Community
Setting a time signature	Signature Set ?	001BAR 4/4	90	○
Setting a Tempo	Tempo Map Set ?	001BAR 1↓120	92	○
Setting the metronome function	Click ↓ ?	oFF	93	○
Setting a preroll time	Preroll Time ?	00	94	○
Setting MIDI sync output signal	MIDI Sync OUT ?	cLk (Clock)	95	○
Setting an MTC frame rate	Frame Rate ?	25 frame	96	○
Setting an MTC offset value	MTC OFFSET	00H 59M 57S 00F 00SF	96	○
Setting Offset mode	Offset Mode ?	ABS	97	○
Setting the slave mode	Slave Mode ?	oFF	98	○
Setting the slave type	Slave Type ?	VAri	99	○
Setting the record protect function	Rec Protect ?	oFF	100	○
Setting digital input tracks	Digi in ?	AdAt, ASYnC	101	●
Setting digital output tracks	Digi out ?	AdAt	102	●
Setting BAR/BEAT resolution mode	↓ Resolution ?	oFF	103	●
Setting the MIDI device ID number	Device ID ?	00	104	●

○ Modes applicable program by program. They can be saved/loaded.

● Modes applicable to all programs. They cannot be saved/loaded.

<Table-2> “Check” menu

Check item	Display	Refer page	Community
Check of the Event number on the track.	NOs Of Event ?	105	-

<Table-3> “Execution” menu

Execution item	Display	Refer page	Community
Deleting a Program	Delete PGM ?	34	-
Editing a Program title	Title Edit PGM ?	35	-
Saving song data to an external digital device	Save PGM ?	75	-
Loading song data from an external digital device	Load PGM ?	75	-
Formatting an current drive disk	Format ?	27	-
Formatting a back-up drive disk	Bk Format ?	30	-

Selecting SETUP mode

Follow the steps below to select the desired SETUP menu in SETUP mode.

1. While the VR800 is stopped, press the SETUP key on the control panel.

Pressing the SETUP key causes the VR800 to enter SETUP mode. The VR800 displays the first hierarchy level of the SETUP menu you selected before you turned off the power. At this time, the menu graphics appear as shown below.

The flashing menu indicator is the currently-selected menu. Turning the JOG dial will select a different menu and the corresponding menu indicator will flash.

2. Select the desired menu using the JOG dial, then press the EXECUTE/YES key.

The VR800 displays the second hierarchy level of the selected SETUP menu, where you can set parameters. (Refer to the next page for more information.)

To exit SETUP mode, press the STOP button or the EXIT/NO key. Each time you press one of these keys, the VR800 returns to the previous hierarchy level of the menu, and finally exits SETUP mode.

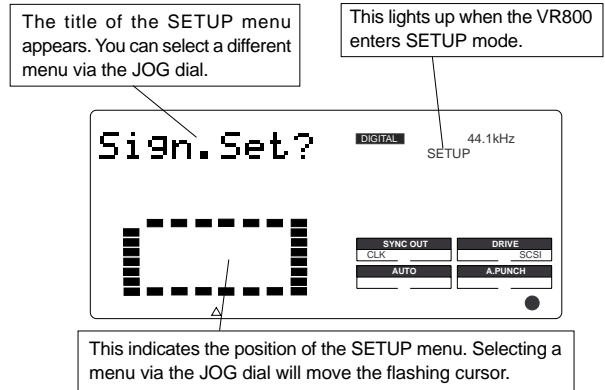

Note: With the factory initial settings, or when you turn on the power again after you format an external SCSI disk, "Sign. Set? (Setting a time signature)" appears. Otherwise, the first hierarchy level of the previously-selected SETUP menu appears.

The following diagram shows the position of each menu.

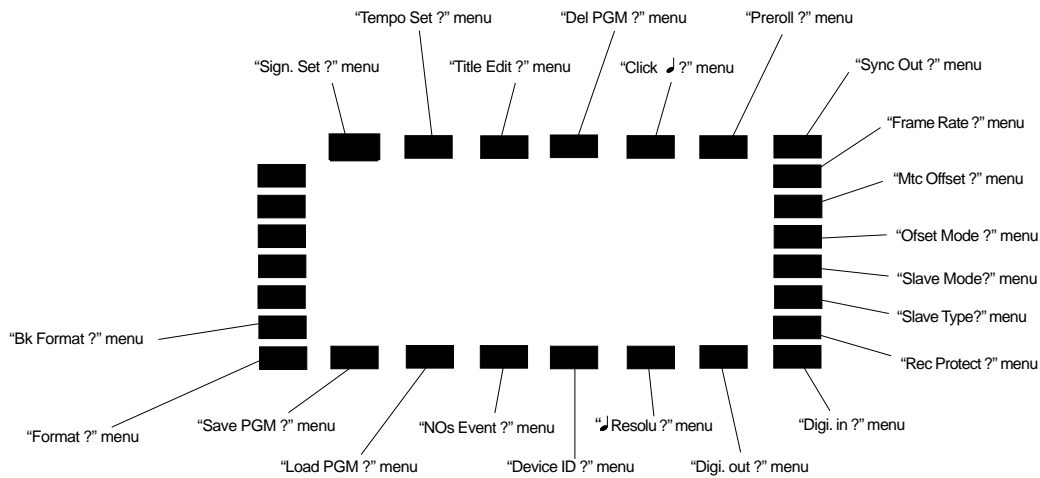

Setting a time signature ("Sign. Set ?" menu)

Using the "Setting a time signature" menu, you can set a time signature of a given measure on the internal programmable Tempo Map. And also in this setting, the BAR (-002BAR, 1♩, 00CLK) displayed at the head of the disk in the time base BAR/BEAT/CLK can be set within the range of -009BAR ~ -002BAR.

For example, you can specify "4/4 for the first and second measures, and 2/4 from the third measure." Setting a time signature and tempo will create a Tempo Map, which allows the VR800 to manage a song using the BAR/BEAT/CLK Time Base. You can also use the Metronome function.

A time signature and tempo setting are required when MIDI clock & Song Position Pointer are output to an external sequencer.

- Initial setting: [4♩4] for bar [001] (not specified for 002 and later.)
 - Setting range of measures: [001] - [999]
 - Setting range of BAR: [-009BAR] - [-002BAR]
 - Setting range of time signatures: [1♩4], [2♩4], [3♩4], [4♩4], [5♩4], [1♩8], [3♩8], [5♩8], [6♩8], [7♩8], [8♩8], [-♩-] (delete)
 - Max. setting points: 64 points
- * You can set time signatures for each Program individually.
 * The settings can be saved and loaded as part of the song data.
 * The settings are maintained after you turn off the power to the unit.

Storing a time signature

1. Select a Program for which to set a time signature.

Refer to "Using the Program Change function" on page 34 for information on selecting a Program.

2. Press the SETUP key, use the JOG dial to select the [Sign.Set ?] menu, then press the EXECUTE/YES key.

The indication changes to [Sign. Chk] and the current time signature appears. The initial setting is [001BAR 4♩4] (4/4 for the first measure).

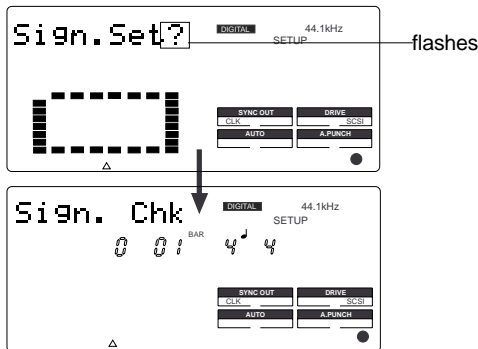

At this time, rotating the JOG dial clockwise enables you to check the current time signatures in sequence. With the initial setting, time signatures after the first measure are all [-BAR-♩-]. This means that a time signature of 4/4 applies to all measures.

3. Press the EXECUTE/YES key.

The indication changes to [Sign. Edit] and [001 (measure)] of [001BAR 4♩4] flashes. You can enter any time signature here.

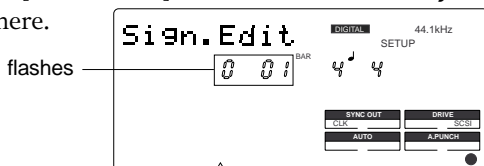

• Rotate the JOG dial to enter the desired measure number.

If you wish to keep the initial setting for the first measure, enter 002. If you try to enter any number other than 001, the time signature indicator shows [-♩-]. This means that no time signature is set for any measures other than the first measure. To change the time signature for the first measure, follow the steps below, without entering any other measure number.

• Press the HOLD/> key, the REWIND button, or the F FWD button to display flashing [-] of [-♩-] and enter the time signature using the JOG dial.

The following measure numbers and time signatures can be entered via the JOG dial.

Measures	001-999, selection of [All Clear?] indication. [All Clear?] means that data in its entirety will be cleared. This is used to initialize the parameter. (Refer to "Clearing stored time signature/tempo data.")
Time signatures	1♩4, 2♩4, 3♩4, 4♩4, 5♩4, 1♩8, 3♩8, 5♩8, 6♩8, 7♩8, 8♩8, -♩- [-♩-] means no time signature assigned, and is used to delete time signature data. (Refer to "Modifying (or deleting) stored time signatures" for more information.)

Note: You cannot assign "- " to measure 001.

4. Press the EXECUTE/YES key whenever you enter a pair of measure/time signature values.

Repeat this step to specify the necessary time signature for the measures.

To cancel the setting operation, or to exit SETUP mode after storing data, press the STOP button or the EXIT/NO key. Each time you press one of these keys, the VR800 returns to the previous hierarchy level of the menu, and finally exits SETUP mode.

Modifying (or deleting) stored time signatures

1. Repeat steps 1-3 described in the "Storing a time signature" section to display [Sign. Edit].
2. Press the HOLD/> key, the REWIND button, or the F FWD button so that the flashing cursor is on the time signature value.
3. Use the JOG dial to enter a new value.
Entering [-] deletes the existing data.
Note that you cannot enter [-] for measure 001.
4. Press the EXECUTE/YES key.

Caution: If modifying or deleting the stored time signature causes the bar/beat setting for the tempo specified in the "Setting a tempo" menu to disappear, the tempo setting will also be automatically erased.

To cancel the setting operation, or to exit SETUP mode after storing data, press the STOP button or the EXIT/NO key. Each time you press one of these keys, the VR800 returns to the previous hierarchy level of the menu, and finally exits SETUP mode.

Clearing all time signature and tempo settings

Caution: Using this function will erase not only the time signature setting but also the tempo data specified in the "Setting a tempo" menu described in the next section.

1. Repeat steps 1-3 described in the "Storing a time signature" section to display [Sign. Edit].
2. While the measure number is flashing, turn the JOG dial counter-clockwise to select [All Clear ?].
When [All Clear ?] appears, [SURE ?] flashes, and you can clear the time signature and tempo data in the next step.

To cancel the All Clear operation, press the STOP button or the EXIT/NO key now. Each time you press one of these keys, the VR800 returns to the previous hierarchy level of the menu, and finally exits SETUP mode.

3. Press the EXECUTE/YES key.
The stored time signature and tempo data in its entirety are cleared, and the initial settings are restored.

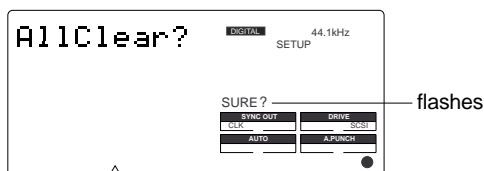

Changing the BAR at ABS "0" of the time base

BAR in -002BAR/1 ↓ /00CLK, which indicates the head figure of the disk in the time base BAR/BEAT/CLK, can be changed. Although the initial figure is -002BAR, this can be set within the range of -009BAR ~ -002BAR.

1. Repeat steps 1-2 described in the "Storing a time signature" section to display [Sign. Chk].
2. Turn the JOG dial counter-clockwise to select [-002 BAR OFFSET].
When the JOG dial is rotated to extreme left [-002BAR OFFSET], as shown below will appear (-002BAR is the initial setup figure).

3. Press the EXECUTE/YES key.
[2] in [-002BAR] will flash and the bar figure can be changed with the JOG dial (Numbers that can be input are 2~9.)

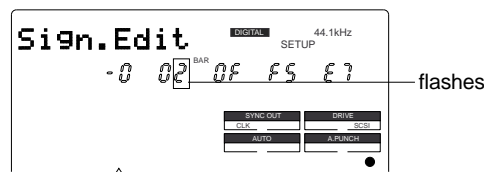
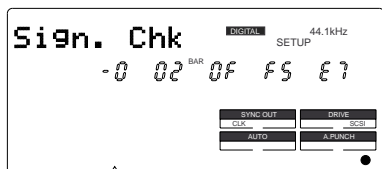

4. Use the JOG dial to enter a new value.
5. Press the EXECUTE/YES key.

Setting a tempo ("Tempo Set ?" menu)

The "Setting a tempo" menu enables you to specify a tempo at a given point in a song that already has a time signature setting. For example, you can specify a tempo of 150 to the third beat of the 12th measure. Time signature and tempo settings make a Tempo Map, which is used by the VR800 to manage the song using the BAR/BEAT/CLK Time Base, and enable the Metronome function. Tempo settings as well as time signature settings are required when you wish to output MIDI clock and Song Position Pointer to an external sequencer.

- Initial setting: bar 001, beat 1 : 120 (001BAR 1 120TEMPO)
 - Setting range of measures : Determined by the time signature setting.
 - Setting range of beats : Determined by the time signature setting.
 - Setting range of tempo : 30-250/quarter note, --- (delete)
 - Max. setting points : 64 points
- * You can set the tempo for each Program individually.
 * The settings can be saved and loaded as part of song data.
 * The settings are maintained after you turn off the power to the unit.

Checking the stored tempo setting

1. Select a Program to check the tempo setting for.

Press the SETUP key, use the JOG dial to select the [Tempo Set ?] menu, then press the EXECUTE/YES key. Indication on the display changes as shown below, and the current tempo appears. The initial setting is [001 BAR 1 TEMPO 120]. This means that a tempo for the first beat of the first measure is set to 120.

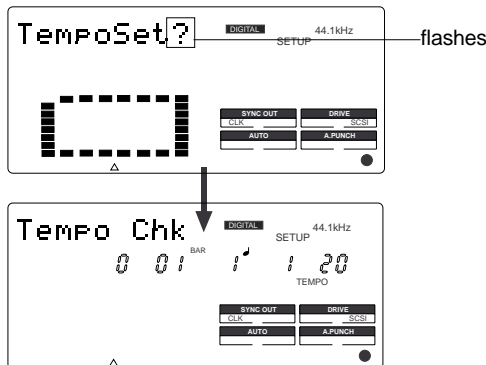

2. Rotate the JOG dial clockwise.

You can view the current tempo values in sequence. Tempo value [--- BAR - TEMPO ---] means that no tempo values are specified after the current setting. With the initial setting, [001 BAR 1 TEMPO 120] is followed by [--- BAR - TEMPO ---].

Storing a tempo value

3. Press the EXECUTE/YES key.

The display indicates [Tempo Edit] and [TEMPO] flashes. (See the figure below.)

This means that you can enter a value now.

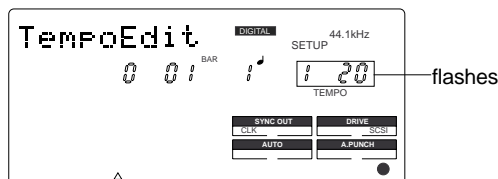

4. Press the HOLD/> key, the REWIND button, or the F FWD button to move the flashing cursor to the desired edit location, and use the JOG dial to enter the bar/beat/tempo information to be stored.

Pressing the HOLD/> key or the F FWD button repeatedly will move the flashing cursor from TEMPO to BAR and to 1, then returns to TEMPO.

Pressing the REWIND button repeatedly will move the cursor in the opposite direction.

The bar and beat settings for the time signatures determine the setting range of bar and beat settings for the tempo. You can specify a tempo between 30 and 250 per quarter note.

The indication [---] means "no tempo," which is used to delete a tempo setting.

When you turn the JOG dial, [---] appears for the bars and beats for which no tempo has been set.

5. Press the EXECUTE/YES key.

The display shows the stored bar/beat/tempo, then returns to the Tempo Edit indication (as shown in step 4).

6. Repeat steps 3-5 to store necessary tempo data.

For example, if you specify tempo values in the song with [001 BAR 4 ♩ 4] and [005 BAR 3 ♩ 4] settings, the Tempo Map includes the settings shown in the table below.

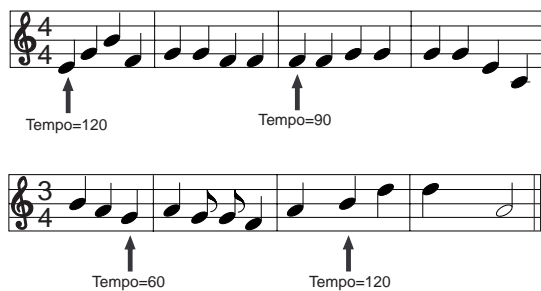

Tempo Map	
Time signature setting	Tempo setting
001 BAR 4 ♩ 4	001 BAR 1 ♩ TEMPO 120 003 BAR 1 ♩ TEMPO 90
005 BAR 3 ♩ 4	005 BAR 3 ♩ TEMPO 60 007 BAR 2 ♩ TEMPO 120

Modifying (or deleting) stored tempo settings

1. Repeat steps 1-3 described in the “Storing a tempo value” section to display [Tempo Edit ?].
2. Press the HOLD/> key, the REWIND button, or the F FWD button so that the flashing cursor is on the measure number. Turn the JOG dial to select bar/beat to edit or delete.
3. Press the HOLD/> key, the REWIND button, or the F FWD button so that the flashing cursor is on the TEMPO number.
4. Use the JOG dial to enter a new value.
Entering [---] deletes the data at the selected bar/beat.
5. Press the EXECUTE/YES key.
6. Press the STOP button or the EXIT/NO key repeatedly to exit SETUP mode.

Setting the Metronome function (“Click ?” menu)

“Setting the Metronome function” menu allows you to determine whether or not the VR800 outputs a metronome sound from Real track 8 during playback or recording. Turning the Metronome function on enables you to record your performance while playing the instrument accompanying the metronome sound.

Note: Since Real track 8 outputs the metronome sound when this function is turned on, you cannot play the audio recorded on this track. Also, do not record any data on track 8. The VR800 can output the metronome sound even from an unrecorded area (outside of the range from ABS 0 to REC END) on track 8.

- Initial setting : [oFF]
- Option : [oFF], or [on]
- * You can turn the function on and off for each Program individually.
- * The settings cannot be saved and loaded as part of the song data.
- * The settings are maintained after you turn off the power to the unit.

Setting the Metronome function

1. While the VR800 is stopped, press the SETUP key to enter SETUP mode.
2. Turn the JOG dial to select [Click ♩ ?] ([?] flashes.), then press the EXECUTE/YES key.
The current setting ([oFF] or [on]) appears on the display. Pressing the EXECUTE/YES key lights up the flashing [?] character steadily; the current setting flashes. The initial setting is [oFF] as shown below.

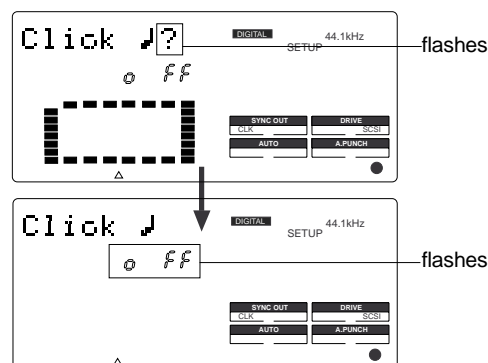

3. Turn the JOG dial to select [on] or [oFF].

Selecting [on] will enable the output of the metronome sound. Selecting [oFF] (initial setting) will disable the metronome output.

4. Press the EXECUTE/YES key.

The display shows the selection (on or oFF), then returns to the indication in step 2.

To cancel the setting operation, or to restore a setting obtained prior to the EXECUTE/YES key press, press the STOP button or the EXIT/NO key. Each time you press one of these keys, the VR800 returns to the previous hierarchy level of the menu, and finally exits SETUP mode and displays the previous Time Base.

Setting a preroll value ("Preroll ?" menu)

The VR800 features the Preroll function that enables you to locate a position a few seconds prior to a specified locate point. The "Setting a preroll value" menu allows you to set the preroll time (in seconds). The Preroll function is convenient when you wish to monitor the audio data from a point slightly before the locate point.

- Initial setting : [00] second
- Setting range of preroll time : [00]-[10] seconds in one second steps
- * You can set the value for each Program individually.
- * The settings can be saved and loaded as part of the song data.
- * The settings are maintained after you turn off the power to the unit.

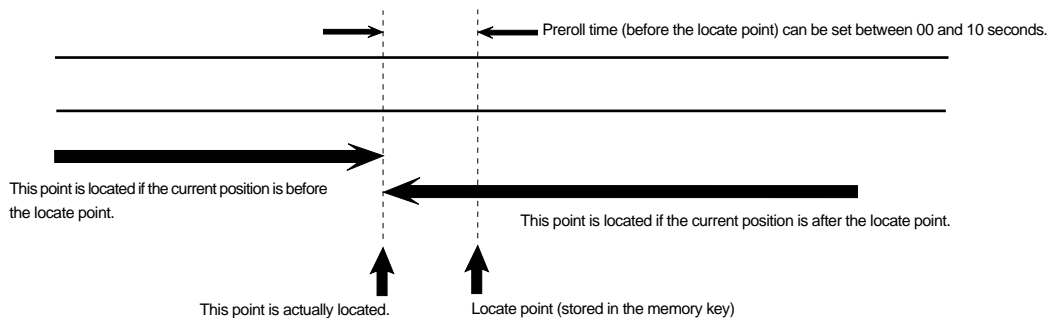

Setting a preroll time

1. While the VR800 is stopped, press the SETUP key to enter SETUP mode.

2. Turn the JOG dial to select [Preroll ?] ([?] flashes.), then press the EXECUTE/YES key.

The current preroll time setting appears on the display. Pressing the EXECUTE/YES key lights up the flashing [?] character steadily; the current setting flashes. The initial setting is [00] as shown below.

3. Turn the JOG dial to enter a desired preroll time value.

You can set a value in one-second increments. Rotating the JOG dial clockwise increases the value, and rotating it counter-clockwise decreases the value.

4. Press the EXECUTE/YES key.

The display shows the value, then returns to the indication that appeared in step 2.

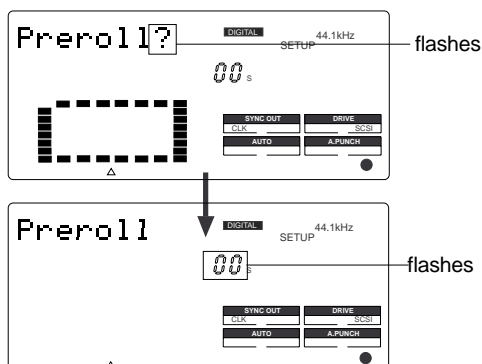

To cancel the setting operation, or to restore the setting obtained prior to the EXECUTE/YES key press, press the STOP button or the EXIT/NO key. Each time you press one of these keys, the VR800 returns to the previous hierarchy level of the menu, and finally exits SETUP mode and displays the previous Time Base.

Setting MIDI sync output signal ("Sync Out ?" menu)

The "Setting MIDI sync output signal" menu enables you to select the type of MIDI sync signals output from the MIDI OUT connector on the rear panel of the VR800 to an external MIDI device.

The options are MIDI clock & Song Position Pointer, or MTC (MIDI time code). Select an appropriate option depending on the type of signal supported by the connected MIDI device.

If you select MIDI clock & Song Position Pointer, first you need to set the time signatures and tempo as described previously. If you select MTC, you first need to set the MTC frame rate, the MTC offset time, and the MTC offset mode as described later.

- Initial setting : [cLK] (clock & Song Position Pointer)
 - Option : [cLK] (clock & Song Position Pointer), [Mtc] (MIDI time code), [oFF] (no output)
- * You can set the parameters for each Program individually.
 * The settings can be saved and loaded as part of the song data.
 * The settings are maintained after you turn off the power to the unit.

Setting MIDI sync signal

1. While the VR800 is stopped, press the SETUP key to enter SETUP mode.

2. Rotate the JOG dial to select [Sync Out ?] ([?] flashes.), then press the EXECUTE/YES key.

The currently-selected MIDI sync signal type appears on the display.

Press the EXECUTE/YES key to turn off the flashing [?] indication. The MIDI sync signal type indication flashes, and the indicator flashes indicating the SYNC OUT setting. The initial setting is [cLK] as shown below.

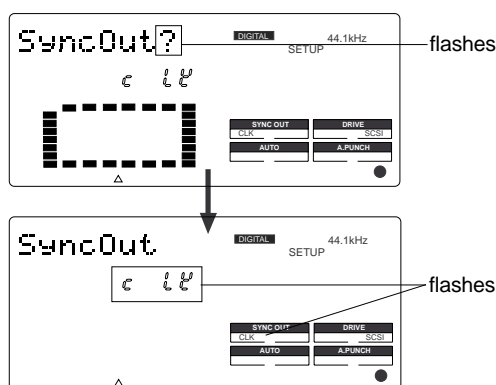

Each option appears on the display as follows.

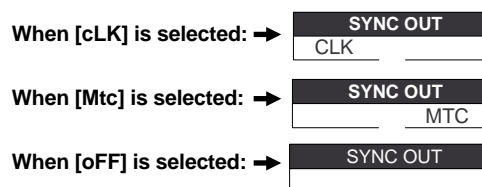

To cancel the setting operation, or to restore a setting obtained prior to the EXECUTE/YES key press, press the STOP button or the EXIT/NO key. Each time you press one of these keys, the VR800 returns to the previous hierarchy level of the menu, and finally exits SETUP mode and displays the previous Time Base.

3. Turn the JOG dial to select the desired MIDI sync signal.

Setting this parameter to [cLK] (initial setting) will select MIDI clock & Song Position Pointer.

Setting the parameter to [Mtc] will select MIDI time code.

With the [oFF] setting, no MIDI sync signal will be output.

4. Press the EXECUTE/YES key.

The selected MIDI sync signal type is stored, and the VR800 returns to the display with the flashing [?] indicator as shown in step 2.

Setting an MTC frame rate ("Frame Rate ?" menu)

The "Setting an MTC frame rate" menu enables you to set the frame rate for MTC output from the MIDI OUT connector of the VR800 to an external MIDI device. If you have already set the type of MIDI sync output signal to [MTC], you need to set the frame rate. Use the frame rate of MTC received by the external MIDI device (or sequence software).

- Initial setting : [25 F] (25 frames)
- Setting range of frame rate : [24 F], [25 F], [30 DF], [30 F]
- * You can set the value for each Program individually.
- * The settings can be saved and loaded as part of the song data.
- * The settings are maintained after you turn off the power to the unit.

Setting an MTC frame rate

1. While the VR800 is stopped, press the **SETUP** key to enter **SETUP** mode.

2. Turn the **JOG** dial to select [**Frame Rate (?)**] (**[e]** and **[?]** flash alternately.), then press the **EXECUTE/YES** key.

The current frame rate setting appears on the display. Press the **EXECUTE/YES** key to turn off the flashing [**?**] character; the current setting flashes. The initial setting of [25 F] flashes as shown below.

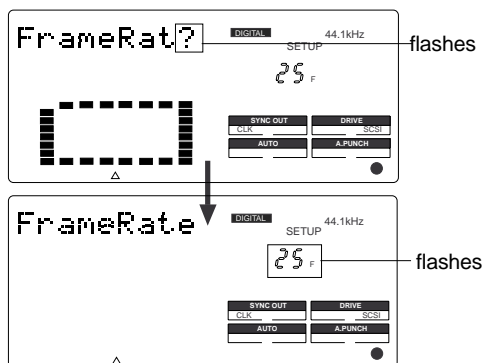

3. Turn the **JOG** dial to enter the desired frame rate.

Rotating the **JOG** dial clockwise or counter-clockwise displays available frame rates as an alternative.

4. Press the **EXECUTE/YES** key.

The selected frame rate is stored and the display returns to the indication with a flashing [**?**] that appeared in step 2.

To cancel the operation, or to restore the setting obtained prior to the **EXECUTE/YES** key press, press the **STOP** button or the **EXIT/NO** key. Each time you press one of these keys, the VR800 returns to the previous hierarchy level of the menu, and finally exits **SETUP** mode and displays the previous **Time Base**.

Setting an MTC offset value ("Mtc Offset ?" menu)

The "Setting an MTC offset value" menu enables you to specify an offset time value - the difference between the time of MTC output from the VR800 and the ABS 00M 00S 00F 00SF time. You need to specify this value if you have selected [Mtc] for the "Setting MIDI sync output signal" menu.

With the initial setting of 00H 59M 57S 00F 00SF, for example, MTC of 59M 57S 00F 00SF is output at the ABS time 00M 00S 00F 00SF. You can also set an offset value from the 001 BAR 1 ♩00 CLK value (bar/beat) on the Tempo Map. Refer to the next section for information on MTC Offset mode.

- Initial setting : [00H: 59M: 57S: 00F: 00SF]
- Setting range of offset time : 00H: 00M: 00S: 00F: 00SF - 23H: 59M: 59S: 29F: 99SF
- * You can set the value for each Program individually.
- * The settings can be saved and loaded as part of the song data.
- * The settings are maintained after you turn off the power to the unit.

Setting an MTC offset

1. While the VR800 is stopped, press the **SETUP** key to enter **SETUP** mode.
2. Turn the **JOG** dial to select **[Mtc Offset (?)]** ([t] and [?] flash alternately.), then press the **EXECUTE/YES** key.

The current offset value appears on the display.

Pressing the **EXECUTE/YES** key turns off the flashing [?] character, and the value in seconds flashes.

You can enter a value at the flashing digit. The number [57] of the initial setting [57S] flashes as shown below.

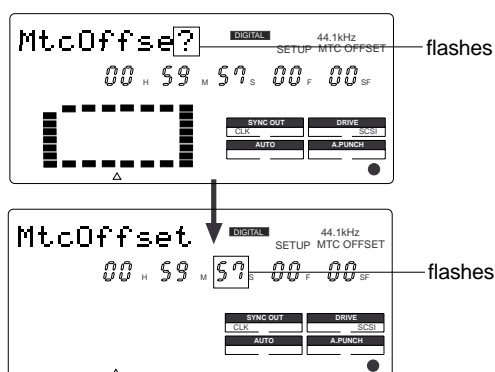

3. Use the **HOLD/>** key, the **REWIND** button, or the **F FWD** button to move the flashing cursor, and turn the **JOG** dial to enter the desired offset value.

Press the **HOLD/>** key or the **F FWD** button to move the flashing cursor to the right, and press the **REWIND** button to move it to the left. Turning the **JOG** dial continuously will round up the number to the next digit.

For example, if you rotate the **JOG** dial on the seconds digit up 59, turning the dial further will increase the number on the digit of minute by one.

4. Press the **EXECUTE/YES** key.

The selected offset value is stored and the display returns to the indication with the flashing [?] that appeared in step 2.

To cancel the operation, or to restore the setting obtained prior to the **EXECUTE/YES** key press, press the **STOP** button or the **EXIT/NO** key. Each time you press one of these keys, the VR800 returns to the previous hierarchy level of the menu, and finally exits **SETUP** mode and displays the previous Time Base.

Note: For example, if you set **MTC Offset** mode to **[ABS]** (see the next section) and you wish to start the song from **MTC's 01H 00M 00S 00F**, you may wish to set a preroll of three seconds with an **MTC offset of 00H 59M 57S 00F**.

Setting Offset mode (“Offset Mode ?” menu)

If you have selected **[MTC]** in the “Setting Offset mode” menu, you need to select **MTC Offset** mode.

This menu enables you to determine whether the specified **MTC** is output at **ABS 00H 00M 00S 00F** or at **001 BAR 1 ♪00 CLK** (bar/beat) of the **Tempo Map**.

Note: As an example, if you set **MTC Offset** mode to **[ABS]** and you wish to start the song from **MTC's 1H 00M 00S 00F**, you may want to set a preroll of three seconds with **MTC offset of 00H 59M 57S 00F**.

If you select **[BAR ♪]** as the **MTC Offset** mode, a preroll of two measures is automatically set. Use **01H 00M 00S 00F**; do not set a preroll value.

Note: If you set **Offset** mode to **[BAR ♪]** and use **MTC** to synchronize sequence software on the computer, the tempo of the sequencer may sometimes slip gradually. This is because the tempo of the **VR800** and the tempo of the software are slightly different even if both use the same tempo. Some sequence software can read the tempo output from the **VR800** correctly. We recommend that you use the tempo of the **VR800** on the sequence software. No such problems will occur if the sequence software synchronizes the **VR800** via **MIDI** clock, instead of **MTC**.

- Initial setting : **[ABS 00H 00M 00S 00F]**
- Offset mode option : **[ABS 00H 00M 00S 00F]**, or **[BAR ♪ 001 BAR 1 ♪]**
- * You can set the mode for each Program individually.
- * The settings can be saved and loaded as part of the song data.
- * The settings are maintained after you turn off the power to the unit.

Setting MTC Offset mode

1. While the VR800 is stopped, press the **SETUP** key to enter **SETUP** mode.

2. Turn the **JOG** dial to select [**Offset Mode (?)**] ([**e**] and [**?**] flash alternately), then press the **EXECUTE/YES** key.

The current offset mode appears on the display. Pressing the **EXECUTE/YES** key to turn off the flashing [**?**] character. The Offset mode indicator flashes as shown below.

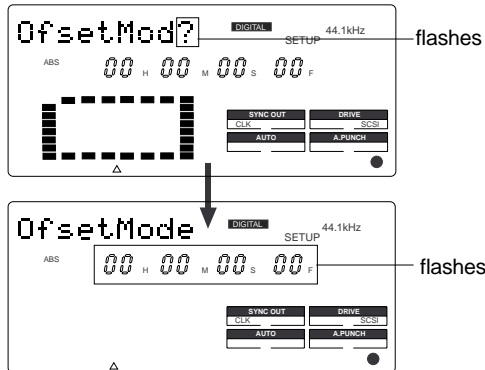

3. Use the **JOG** dial to select the desired **Offset mode**.

Rotating the **JOG** dial clockwise or counter-clockwise will alternately show a flashing [**ABS 00H 00M 00S 00F**] and [**001BAR 1 ♪**].

If you select [**ABS 00H 00M 00S 00F**], the specified MTC offset time is output at **ABS 00H 00M 00S 00F**.

If you select [**001BAR 1 ♪**], the specified MTC offset time is output at **001 BAR 1 ♪ 00 CLK** of the Tempo Map.

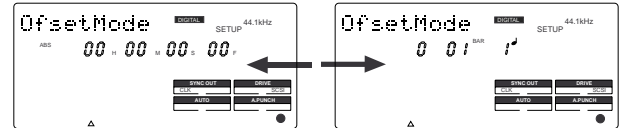

4. Press the **EXECUTE/YES** key.

The selected offset mode is stored and the display returns to the indication with flashing [**e**] and [**?**].

To cancel the operation, or to restore the setting obtained prior to the **EXECUTE/YES** key press, press the **STOP** button or the **EXIT/NO** key. Each time you press one of these keys, the VR800 returns to the previous hierarchy level of the menu, and finally exits **SETUP** mode and displays the previous Time Base.

Setting the Slave mode ("Slave Mode ?" menu)

The "Setting the Slave mode" menu allows you to set Slave mode of the VR800 to on and off.

When Slave mode is turned on, the VR800 will lock to MTC input from the master device.

With this menu setting, you can set up a system in which multiple VR800s operate in sync or an VR800 synchronizes to a Fostex digital multitrack recorder, as well as the VR800 locking to MTC output from the sequence software.

- Initial setting : [o FF]
- Option : [on] or [o FF]

- * You can set the mode for each Program individually.
- * The settings can be saved and loaded as part of song data.
- * The settings are maintained after you turn off the power to the unit.
- * The Program is automatically checked before the operation.
- * The sampling rate is automatically checked before the operation.

Turning Slave mode on and off

1. While the VR800 is stopped, press the **SETUP** key to enter **SETUP** mode.

2. Turn the **JOG** dial to select [**Slave Mode (?)**] ([**e**] and [**?**] flash alternately), then press the **EXECUTE/YES** key.

The current slave mode appears on the display. Pressing the **EXECUTE/YES** key turns off the flashing [**?**] character, and the Slave mode indicator flashes. With the initial setting, [**o FF**] flashes as shown below.

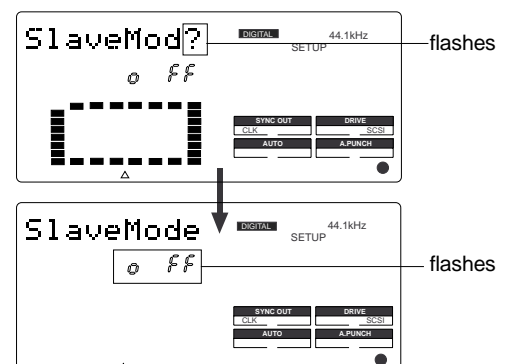

3. Use the JOG dial to turn Slave mode on and off.

Rotating the JOG dial clockwise and counter-clockwise alternates flashing [on] and [oFF].

Selecting [on] turns Slave mode on, and selecting [oFF] turns Slave mode off.

4. Press the EXECUTE/YES key.

If you select [oFF], [e] and [?] flash alternately.

If you select [on], [e] and [?] flash alternately and [SLAVE] flashes as shown below.

This means that the VR800 has not locked to the sync signal. When the VR800 locks to the sync signal from the master device, [SLAVE] lights up steadily.

After you set Slave mode to [on], you need to select the Slave type (type of sync signal) described in the next section.

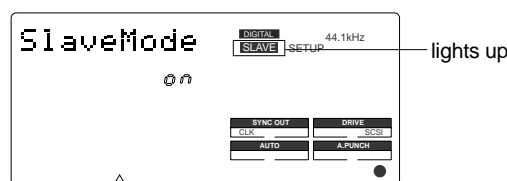

To cancel the operation, or to restore the setting obtained prior to the EXECUTE/YES key press, press the STOP button or the EXIT/NO key. Each time you press one of these keys, the VR800 returns to the previous hierarchy level of the menu, and finally exits SETUP mode and displays the previous Time Base.

Setting the Slave type ("Slave Type ?" menu)

The "Setting the Slave type" menu enables you to setup how VR800 should function after chase lock, when VR800 is set to sync externally in "slave mode ON" by the previously mentioned "Setting the slave mode."

- Initial setting : [VAri]
 - Option : [VA ri], [Fr EE]
 - [VA ri]: The VR800 synchronizes only to external MTC.
 - [Fr EE]: The VR800 locks to MTC, then synchronizes to the internal clock.
- * You can set the parameter for each Program individually.
 * The settings can be saved and loaded as part of the song data.
 * The settings are maintained after you turn off the power to the unit.
 * The Program is automatically checked before the operation.
 * The sampling rate is automatically checked before the operation.

Setting the Slave type

1. While the VR800 is stopped, press the SETUP key to enter SETUP mode.

2. Turn the JOG dial to select [Slave Type (?)] ([e] and [?] flash alternately), then press the EXECUTE/YES key.

The current Slave type appears on the display. Pressing the EXECUTE/YES key turns off the flashing [?] character, and the Slave type indicator flashes. With the initial setting, [VA ri] flashes as shown below.

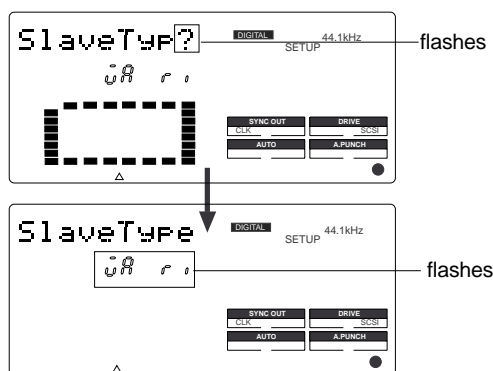

3. Use the JOG dial to select the desired Slave type.

Rotating the JOG dial clockwise and counter-clockwise will cause the [VA ri] and [Fr EE] indicators to flash in sequence.

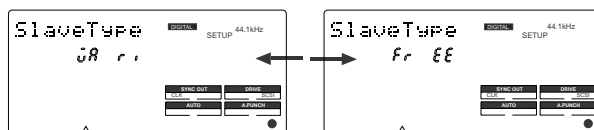

<Notes>

- You need to input MTC from an external device to the VR800 with any Slave type.
- The VR800 re-chase window is fixed to ten frames. That is, if an offset between the master device and slave device exceeds ten frames, the VR800 interprets that as out of sync, and tries to chase and lock to MTC sent from the master device. (This operation is called "re-chasing.") During the re-chase operation, audio output is muted. If the slave machine slips with MTC from the master device by less than ten frames, the slave machine continues running while recognizing the slippage.
- When you set the Slave type, the Vari Pitch function is automatically disabled. (The [VARI PITCH] indicator turns off.)

4. Press the EXECUTE/YES key.

The selected Slave type is stored, and [e] and [?] flash alternately.

To cancel the operation, or to restore the setting obtained prior to the EXECUTE/YES key press, press the STOP button or the EXIT/NO key. Each time you press one of these keys, the VR800 returns to the previous hierarchy level of the menu, and finally exits SETUP mode and displays the previous Time Base.

Setting the Record Protect function ("Rec Protect ?" menu)

The VR800 features the Record Protect function, which is similar to the function of record-protect tabs on cassette tapes. The "Setting the Record Protect function" menu allows you to turn the Record Protect function on and off. When this function is turned on, you cannot record, paste, or erase data. Use this function to protect your precious data from being erased accidentally.

- Initial setting : [o FF]
- Option : [on] or [o FF]
- * You can turn the function on and off for each Program individually.
- * The settings can be saved and loaded as part of the song data.
- * The settings are maintained after you turn off the power to the unit.
- * The Program is automatically checked before the operation.

Recording enabled/disabled

1. While the VR800 is stopped, press the SETUP key to enter SETUP mode.

2. Turn the JOG dial to select [Rec Protct (?)] ([t] and [?] flash alternately), then press the EXECUTE/YES key.

The current setting appears on the display. Pressing the EXECUTE/YES key turns off the flashing [?] character, and the recording enabled/disabled indicator flashes. With the initial setting, [o FF] flashes as shown below.

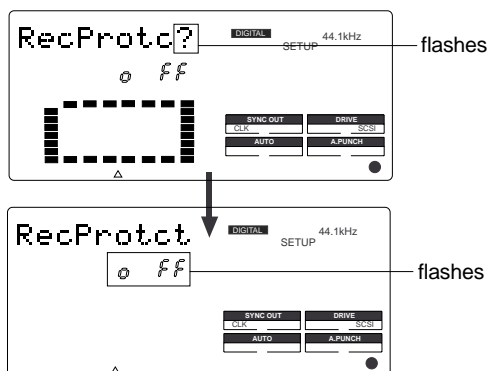

3. Use the JOG dial to enable or disable recording.

Rotating the JOG dial clockwise and counter-clockwise will flash [on] and [o FF] alternately. Selecting [o FF] enables recording; you can record, paste, and erase data. Selecting [on] disables recording; and you cannot record, paste, or erase data.

Note: When recording is disabled (on) and you try to record, paste, or erase data, the VR800 displays [Protected] for a second, indicating that you cannot perform the operation. To perform the operation, you need to enable recording (oFF).

4. Press the EXECUTE/YES key.

[t] and [?] flash alternately.

To cancel the operation, or to restore the setting obtained prior to the EXECUTE/YES key press, press the STOP button or the EXIT/NO key. Each time you press one of these keys, the VR800 returns to the previous hierarchy level of the menu, and finally exits SETUP mode and displays the previous Time Base.

Setting digital input tracks (“Digi. In ?” menu)

The “Setting a digital input track” menu enables you to assign digital signals (adat digital signal or S/P DIF digital signal) input at the DATA IN connector on the VR800 to tracks. It also enables you to make the digital-in clock setting. Typically, the digital input track is set to [AdAt] (adat digital signal), assuming that a digital mixer with adat I/O is connected to the VR800. Channels 1-8 are routed to tracks 1-8. Digital-in clock is set to “ASYNc (asynchronous).” You may assign digital input tracks to any two tracks (S/P DIF digital signals) or set digital-in clock to “SYnC (synchronous).”

- Initial setting : AdAT ASYNc (Asynchronous)
 - Assignable tracks : L channel = AdAT, 1 ~ 8
: R channel = 1 ~ 8
 - Setting digital-in clock : ASYNc (Asynchronous)
: SYnC (Synchronous)
- * This setting is shared by all Programs in the same disk.
* The settings cannot be saved and loaded as part of the song data.
* The settings are maintained after you turn off the power to the unit.

Setting digital input tracks

1. While the VR800 is stopped, press the **SETUP** key to enter **SETUP** mode.

2. Turn the **JOG** dial to select [Digi. in ?] ([?] flash alternately), then press the **EXECUTE/YES** key.

When you select [Digi. in ?], the VR800 displays the current digital input track and digital-in clock settings. When you press the EXECUTE/YES key, the flashing [?] disappears and the digital input track indication starts to flash. With the default setting, [AdAt] starts flashing and [ASYNc] lights up as shown below.

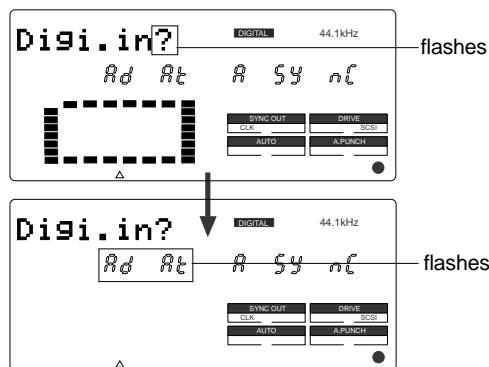

3. While the [AdAt] is flashing, turn the **JOG** dial.

When you turn the JOG dial, the flashing [AdAt] indicator changes to the S/P DIF digital input track indication.

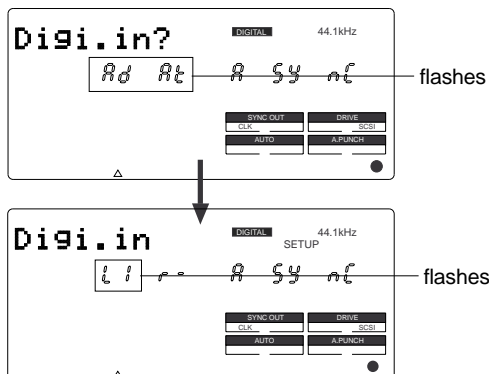

4. Turn the **JOG** dial to select a track with a flashing channel number. To change a flashing number, use the **HOLD/>** key, **REW** button, or **F FWD** button.

Turning the JOG dial while [L*] is flashing enables you to select from channels 1-8 and AdAt. Turning the JOG dial while [r*] is flashing enables you to select from channels 1-8.

Note: You cannot assign L channel and R channel to the same track. If you assign the same track and press the EXECUTE/YES key, the last channel you set will have priority, and the first channel will be automatically set to [-]. For example, if you assign L channel to [2], then assign R channel to [2], and press the EXECUTE/YES key, L channel will be set to [L-], and R channel will be set to [r-2].

5. After you select a track to assign, press the **EXECUTE/YES** key.

The selected track will be registered, and the display shown in step 2 appears.

When a digital signal that matches the digital input track setting is input, [DIGITAL] lights up on the display. If the signal is different than the setting (for example, if S/P DIF signal is input while the digital input track is set to [AdAt]) the [DIGITAL] indicator will flash.

Note: If [DIGITAL] flashes on the display, check the connection with the external device, and the settings on the VR800 and the external device.

To cancel the operation, or to restore the setting obtained prior to the EXECUTE/YES key press, press the STOP button or the EXIT/NO key. Each time you press one of these keys, the VR800 returns to the previous hierarchy level of the menu, and finally exits SETUP mode and displays the previous Time Base.

Setting a clock of digital in

1. While the digital input track setting ([AdAt], [*L], or [r*]) is flashing, press the HOLD/> key, REW button, or F FWD button so that [A SYnC] will flash. The "●" indicator will also flash.

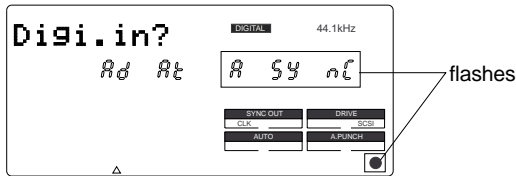

2. Turn the JOG dial to select [ASYnC] or [SYnC]. In [A SYnC] mode, the system does not synchronize the digital-in clock. In [SYnC] mode, the system synchronizes the digital-in clock.

3. After you select the clock, press the EXECUTE/YES key.

The selected clock will be registered, and the display shown in step 2 appears.

Note: Set the digital-in clock and the digital mixer clock carefully if the VR800 is connected to a digital mixer. Refer to "Connecting a digital mixer" in the Quick Operation Guide.

Setting digital output tracks ("Digi. Out ?" menu)

The "Setting digital output tracks" menu enables you to assign the track that outputs digital signals from the DATA OUT connector of the VR800 to an external digital device. You can send the recorded audio data on the VR800 to an external digital device (MD, DAT, adat, digital mixer, etc.) in digital form. Any two tracks selected from tracks [1]–[8] are assignable. You can also select [AdAt] to output all track data (1–8) simultaneously to a digital device with an adat input.

- Initial setting :AdAt
- Assignable tracks: L channel = [AdAt], [1] ~ [8]
R channel = [1] ~ [8]

- * This setting is shared by all Programs in the same disk.
- * The settings cannot be saved and loaded as part of the song data.
- * The settings are maintained after you turn off the power to the unit.

<IMPORTANT>

Match the sampling rate of the digital input on the external device with the sampling rate of the VR800 to send digital signals from the VR800 to the external device.

Setting digital output tracks

1. While the VR800 is stopped, press the SETUP key to enter SETUP mode.

2. Turn the JOG dial to select [Digi. out ?] ([?] flashes), then press the EXECUTE/YES key.

The current digital output track assignment appears on the display.

Pressing the EXECUTE/YES key turns off the flashing [?] character, and setting of the digital output track flashes.

With the initial setting, [AdAt] flashes as shown below.

You can select a flashing channel to assign a track.

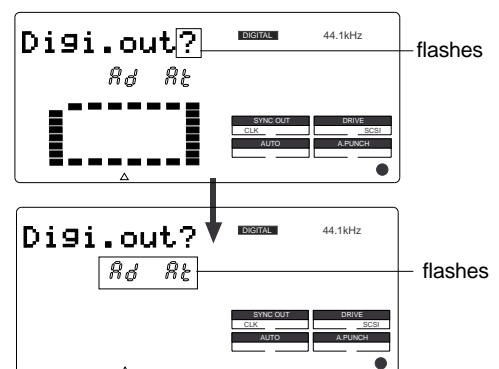

3. While the [AdAt] is flashing, turn the JOG dial.

When you turn the JOG dial, the flashing [AdAt] indicator changes to the S/P DIF digital output track indication.

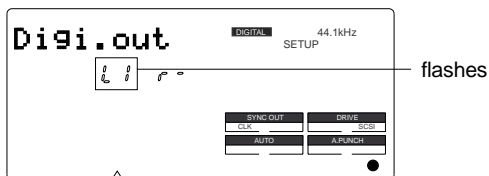

Note: At setup of the digital output track, tracks to be assigned to L and R cannot be the same, for example, such as L-4 and r-4. Should setup be executed by mistakenly selecting same track numbers for L and R, the number setup for the L channel will be given priority and “-” (no assign) will be setup automatically for R. In other words, L channel will be setup to the specified track and R channel will be setup to “-.”

4. Press the HOLD/> key, the REWIND button, or the F FWD button to select a channel (L or r) and use the JOG dial to specify a track.

5. Press the EXECUTE/YES key.
The selected track assignment is stored, and [?] flashes.

To cancel the operation, or to restore the setting obtained prior to the EXECUTE/YES key press, press the STOP button or the EXIT/NO key. Each time you press one of these keys, the VR800 returns to the previous hierarchy level of the menu, and finally exits SETUP mode and displays the previous Time Base.

Setting BAR/BEAT resolution mode (“Resolu ?” menu)

The “Setting BAR/BEAT resolution mode” menu enables you to turn BAR/BEAT resolution mode on and off. The initial setting is “off.” When you turn this mode on, the CLK (clock) digits will be always round off to 00 and be stored in the memory key while the VR800 is using the BAR/BEAT/CLK Time Base. That is, beat resolution is used. Using this function allows you to automatically store a beat-resolution value of the CLIPBOARD IN/OUT points and other points in real-time. (Press the STORE key, then the corresponding memory key while playing the VR800.) Therefore, it is very convenient when you perform the Copy & Past or Move & Paste operation in beat-resolution.

For example, assume that you have stored the value for 001BAR1 ♪46 CLK as the CLIPBOARD IN point, and the value for 002BAR 4 ♪51 CLK as the CLIPBOARD OUT point. These values will be used as they are if BAR/BEAT resolution mode is turned off. However, the mode is turned on, the following values will be stored instead. The following example has a time signature setting of 4/4.

001BAR1 ♪46 CLK -> 001BAR1 ♪00 CLK (A CLK value of 46 will be rounded off.)
002BAR4 ♪51 CLK -> 003BAR1 ♪00 CLK (A CLK value of 51 will be rounded up.)

- Initial setting : [o FF]
- Options : [on] or [o FF]
- * This setting is shared by all Programs in the same disk.
- * The settings cannot be saved and loaded as part of the song data.
- * The settings are maintained after you turn off the power to the unit.

Setting BAR/BEAT resolution mode

1. While the VR800 is stopped, press the SETUP key to enter SETUP mode.

2. Turn the JOG dial to select [♪ Resolu ?] ([?] flashes), then press the EXECUTE/YES key.
The current BAR/BEAT resolution mode setting appears on the display.
Pressing the EXECUTE/YES key turns off the flashing [?] character, and the BAR/BEAT resolution mode setting flashes. With the initial setting, [o FF] flashes as shown below.

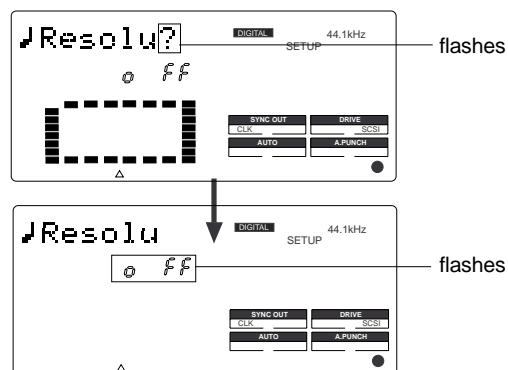

3. Use the JOG dial to turn the mode [on] or [off].

When you turn the JOG dial clockwise and counter-clockwise, [on] and [o FF] flash alternately. Selecting [on] turns BAR/BEAT resolution mode on, and selecting [o FF] turns BAR/BEAT resolution mode off.

4. Press the EXECUTE/YES key.

The selected mode setting is stored, and [?] flashes.

To cancel the operation, or to restore the setting obtained prior to the EXECUTE/YES key press, press the STOP button or the EXIT/NO key. Each time you press one of these keys, the VR800 returns to the previous hierarchy level of the menu, and finally exits SETUP mode and displays the previous Time Base.

Setting the MIDI device number ("Device ID ?" menu)

The "Setting the MIDI device number" menu enables you to set the VR800 device ID number required to control the unit from a sequence software using MMC (MIDI Machine Control) or FEX (Fostex System Exclusive Message). The transmit device ID links to this setting. You can set the device ID from 00 to 99. However, if the device ID number of the message the VR800 receives is [7F], the VR800 will recognize it to perform the corresponding operation, regardless of its device ID setting.

- Initial setting : [00]
- Device ID : [00] ~ [99]
- * This setting is shared by all Programs in the same disk.
- * The settings cannot be saved and loaded as part of the song data.
- * The settings are maintained after you turn off the power to the unit.

Setting the MIDI device ID

1. While the VR800 is stopped, press the SETUP key to enter SETUP mode.

2. Turn the JOG dial to select [Device ID?] ([?] flashes), then press the EXECUTE/YES key.

The current MIDI device ID number appears on the display. Pressing the EXECUTE/YES key turns off the flashing [?] character, and the MIDI device ID number flashes. With the initial setting, [00] flashes as shown below.

4. Press the EXECUTE/YES key.

The MIDI device ID number is stored, and [?] flashes.

To cancel the operation, or to restore the setting obtained prior to the EXECUTE/YES key press, press the STOP button or the EXIT/NO key. Each time you press one of these keys, the VR800 returns to the previous hierarchy level of the menu, and finally exits SETUP mode and displays the previous Time Base.

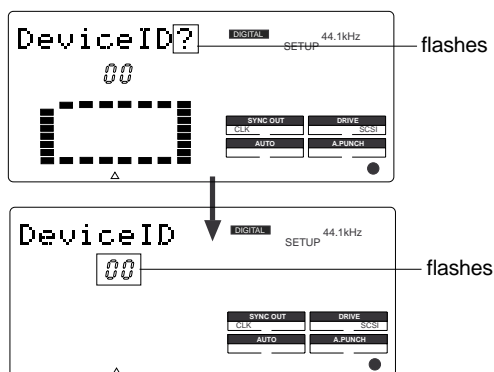

3. Use the JOG dial to set the desired MIDI device ID number.

Turning the JOG dial clockwise increments the value, and turning it counter-clockwise decrements the value.

Checking the number of track events ("NOs Event ?" menu)

The "Checking the number of track events" menu enables you to check the number of events on each track. Each track (including Additional tracks) of VR800 Programs consists of consecutive audio files (and "zero" files). The number of events represents the total number of audio files and 0 files. Each track can contain up to 512 events.

If you are editing a song of typical length (about six minutes), repeated editing operation does not usually cause this maximum number to be exceeded. (Exceeding this limit is called "event number overflow.") Even a 20-minute song will not cause event number overflow. This is because the VR800 system always optimizes the data structure by keeping the number of events low. However, if a recording on a track is scattered in different areas of the disk, or if you have made a very long recording on a single track and performed many edits, you should be wary of "event number overflow." To avoid this problem, use the "Checking the number of track events" menu to check the number of events on each track prior to recording or editing.

Checking the number of track events

1. While the VR800 is stopped, press the **SETUP** key to enter **SETUP** mode.

2. Turn the **JOG** dial to select **[NOs Event?] ([?]** flashes), and then press the **EXECUTE/YES** key.

The screen changes as follows, indicating the number of events on track 1. (In this example, track 1 includes eight events.)

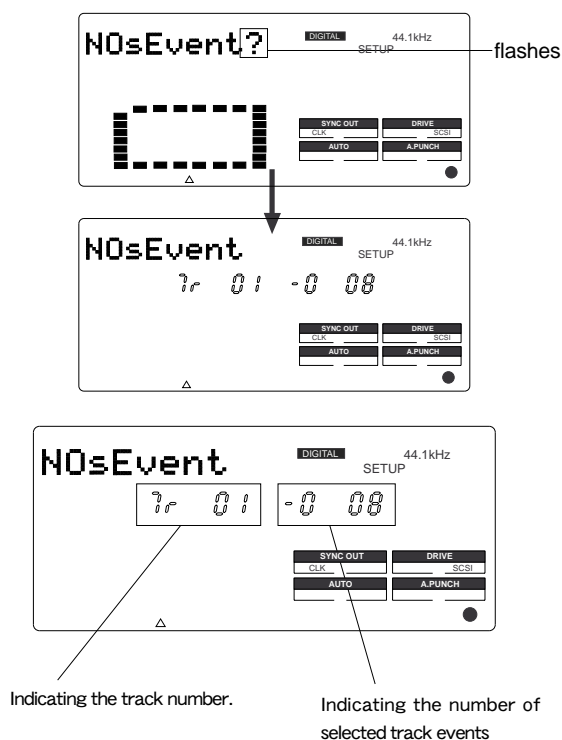

To cancel the operation, or to restore the setting obtained prior to the EXECUTE/YES key press, press the **STOP** button or the **EXIT/NO** key. Each time you press one of these keys, the VR800 returns to the previous hierarchy level of the menu, and finally exits SETUP mode and displays the previous Time Base.

* For more information on audio files and events, refer to the "Audio file and event" section of the "Before Starting" chapter.

3. Use the **JOG** dial to select another (01-24) to check the number of events on the corresponding track.

4. Press the **EXIT/NO** key or the **STOP** button repeatedly to exit **SETUP** mode.

(Digital Multitrack Recorder)
Model VR800

MIDI Implementation Chart

Date:
Version: V1.00

Function.....	Transmitted	Recognized	Remarks
Basic Channel	Default X Changed X	X X	
Mode	Default X Message X Altered *****	X X X	
Note Number:	True voice *****	X X	
Velocity	Note ON X Note OFF X	X X	
After Touch	Key's X Channel's X	X X	
Pitch Bend	X	X	
Control Change	X	X	
Program Change:	True # X *****	X X	
System Exclusive	<input type="radio"/> (rem. 1)	<input type="radio"/> (rem. 2)	
Common	: Quarter frame <input type="radio"/> : Song Position <input type="radio"/> : Song Select X : Tune X	<input type="radio"/> X X X	
System Real Time	: Clock <input type="radio"/> : Commands <input type="radio"/> (rem. 3)	X X	
Aux. Message	: Local ON/OFF X : All Notes OFF X : Active Sense X : Reset X	X X X X	
Notes	rem. 1: MMC (Device ID=00~99, 127), MTC, Identity reply, FOSTEX Exclusive rem. 2: MMC (Device ID=00~99, 127), MTC, Inquiry, FOSTEX Exclusive rem. 3: START, STOP, CONTINUE		

Mode 1: OMNI ON, POLY
Mode 3: OMNI OFF, POLY

Mode 2: OMNI ON, MONO
Mode 4: OMNI OFF, MONO

: Yes
X : No

MMC Command List

Command List	Movement (Recorder)
01: STOP	STOP
02: PLAY	PLAY
03: DEFERRED PLAY	DEFERRED PLAY
04: FAST FORWARD	F FWD
05: REWIND	REWIND
06: RECORD STROBE	REC
07: RECORD EXIT	PUNCH OUT
09: PAUSE	STOP
40: WRITE	Refer to MMC Response/Information Field List
41: MASKED WRITE	Refer to MMC Response/Information Field List
42: READ	Refer to MMC Response/Information Field List
44: LOCATE	LOCATE to Setting Data
46: SEARCH	CUE/REVIEW (+/- 1~60 times)
47: SHUTTLE	CUE/REVIEW (+/- 1~60 times)
4C: MOVE	Refer to MMC Response/Information Field List
4D: ADD	Refer to MMC Response/Information Field List
4E: SUBTRACT	Refer to MMC Response/Information Field List

MMC Response/Information Field List	Command
01: SELECTED TIME CODE	READ/WRITE/MOVE/ADD/SUBTRACT
03: REQUESTED OFFSET	READ/WRITE
04: ACTUAL OFFSET	READ
08: GP 0	READ/WRITE/MOVE/ADD/SUBTRACT
09: GP 1	READ/WRITE/MOVE/ADD/SUBTRACT
0A: GP 2	READ/WRITE/MOVE/ADD/SUBTRACT
0B: GP 3	READ/WRITE/MOVE/ADD/SUBTRACT
0C: GP 4	READ/WRITE/MOVE/ADD/SUBTRACT
0D: GP 5	READ/WRITE/MOVE/ADD/SUBTRACT
0E: GP 6	READ/WRITE/MOVE/ADD/SUBTRACT
0F: GP 7	READ/WRITE/MOVE/ADD/SUBTRACT
48: MOTION CONTROL TALLY	READ
4C: RECORD MODE	READ/WRITE
4E: TRACK RECORD STATUS	READ
4F: TRACK RECORD READY	READ/WRITE/MASKED WRITE
51: RECORD MONITOR	READ/WRITE

Inquiry Message List

IDENTITY REQUEST: F0, 7E, <channel>, 06, 01, F7
IDENTITY REPLY: F0, 7E, <channel>, 06, 02, 51, 01, 00, 0E, 00, 01, 00, 7F, 7F, F7
51: Fostex ID
01, 00: Device family code
0E, 00: Device family number VR800
01, 00, 7F, 7F: Software version

Fostex MIDI System Exclusive Message Format for VR800

<Note>

Following protocol is effective only in equipment which will reply by -
 Identity Reply=F0 7E<channel>06 02 51 01 00 0E 00 01 ** ** ** F7 (VR800)
 against the Inquiry Message=F0 7E<channel>06 01.

Fostex System Exclusive Message

General Structure=F0 51<device id><sub id 1>(<data>)F7

* Numbers are all expressed in hexadecimal units.

Table: <sub id 1> (<data>)

Command or Model Set Controller to VR800	Acknowledge or Status VR800 to Controller
Loop on/off 12 22 (<on/off>)	
Post locate 12 28 (<post locate mode>)	
Auto rec 12 2D (<on/off>)	32 2D (<edit message>)
Lock enable 12 41 (<lock enable>)	
Lock mode 12 42 (<lock mode>)	
Copy clip 12 45 (<count><mmc track>)	32 45 (<edit message>)
Copy paste 12 46 (<count=01><repeat count>) or 12 46 (<count><repeat count><mmc track>)	32 46 (<edit message>)
Erase 12 47 (<count><mmc track>)	32 47 (<edit message>)
Clipboard play 12 49	32 49 (<edit message><mmc track>)
Undo 12 4A	32 4A (<edit message>)
Redo 12 4B	32 4B (<edit message>)
Move clip 12 4D (<count><mmc track>)	32 4D (<edit message>)
Move paste 12 4E (<count=01><repeat count>) or 12 4E (<count><repeat count><mmc track>)	32 4E (<edit message>)
Track exchange 12 4F (<channel><channel>)	32 4F (<edit message>)
New program 13 3E	33 3E (<edit message>)
Delete program 13 3F	33 3F (<edit message>)
Digital in ch. 13 41 (<channel><channel>)	
Digital out ch. 13 42 (<channel><channel>) * Refer to Note.	
Move clip 12 4D (<count><mmc track>)	32 4D (<edit message>)
Program change 13 43 (<program>)	
Click on/off 13 44 (<on/off>)	
Resolution on/off 13 46 (<on/off>)	
Midi Sync out 13 47 (<nidi sync>)	
MTC offset mode 13 48 (<MTC offset mode>)	
Vari pitch 13 49 (<count=3><on/off><vari pitch>) or 13 49 (<count=1><on/off>)	
Signature set 14 01 (<signature map>)	34 00 (<edit message>)
Tempo set 14 02 (<tempo set map>)	34 00 (<edit message>)
Tempo map all erase 14 03	34 00 (<edit message>)
Preroll time set 14 04 (<mmc time>)	
Frame rate set 14 06 (<frame rate>)	
Time base set 14 08 (<time base>)	

Status Request

Status request command Controller to VR800		Status reply VR800 to controller
Loop op. status	22 21	32 21 (<Loop op. mode = 12>)
Loop status	22 22	32 22 (<on/off>)
Post locate status	22 28	32 28 (<post locate status>)
Auto rec status	22 2D	32 2D (<edit message>)
Lock status	22 41	32 41 (<lock status>)
Lock mode status	22 42	32 42 (<lock mode>)
Copy clip status	22 45	32 45 (<edit message=01 or =14>)
Copy paste status	22 46	32 46 (<edit message=02><mmc time>) or 32 46 (<edit message=00>)
Erase status	22 47	32 47 (<edit message=02><mmc time>) or 32 47 (<edit message=00>)
Move clip status	22 4D	32 4D (<edit message=01 or =14>)
Move paste status	22 4E	32 4E (<edit message=02><mmc time>) or 32 4E (<edit message=00>)
Digital in ch. st.	23 41	33 41 (<channel><channel>)
Adat in status	23 41	33 41 (<channel=7F><count><mmc track>)
Digital out ch. st.	23 42	33 42 (<channel><channel>)
Adat out status	23 42	33 42 (<channel=7F><channel=0>)
Program status	23 43	33 43 (<program>)
Click status	23 44	33 44 (<on/off>)
Level status	23 45	33 45 (<count=10><level data>)
resolution status	23 46	33 46 (<on/off>)
midi sync out status	23 47	33 47 (<midi sync>)
MTC offset mode status	23 48	33 48 (<MTC offset mode>)
vari pitch status	23 49	33 49 (<count=3><on/off><vari pitch>)
signature map req.	24 01(<event number>)	34 01 (<signature map>)
tempo set map req.	24 02(<event number>)	34 02 (<tempo set map>)
preroll time req.	24 04	34 04 (<mmc time>)
remain time req.	24 05	34 05 (<mmc time>)
frame rate status	24 06	34 06 (<frame rate>)
time base status	24 08	34 08 (<time base>)

<Note 2>

There is a limitation on specifying the <channel><channel> setting. For details, refer to "Explanation on Command/Mode Set" mentioned in later pages.

<Allocation of GP0~GP7>

Edit point memory of this equipment is allotted to the response/information field of 08~0F (GP0~GP7) as shown below.

GP7 however, will be used as the work memory for small adjusting of the registered figure (Refer to Examples 4 and 5).

<Response/Information Field>

08 GP0 : locate memory	09 GP1 : clipboard in memory
0A GP2 : clipboard out memory	0B GP3 : start memory
0C GP4 : auto punch in memory	0D GP5 : auto punch out memory
0E GP6 : end memory	0F GP7 : reserved

[Example 1] <mmc time> is registered in the start memory (using the write command).

F0 7F <device ID> 06 <write = 40> <count> <GP3 = 0B> <mmc time> F7

[Example 2] Locate memory is recalled (using the read command).

F0 7F <device ID> 06 <read = 42> <count> <GP3 = 0B> <mmc time> F7

[Example 3] On-the-fly registering in the punch in memory (using the move command).

F0 7F <device ID> 06 <move = 4C> <count> <destination = 0C (GP4) > <source = selected time code = 01> F7

[Example 4] When + 1 frame is to be set in the punch in memory (using the add command).

* Time figure to be added is pre-registered in GP7 (Set 00h 00m 00s 01f in GP7).

F0 7F <device ID> 06 <add = 4D> <count> <destination = 0C (GP4)> <source #1 = 01 (GP4)> <source #2 = 0F (GP7)> F7

[Example 5] When -1 frame is to be set in the punch in memory (using the subtract command).

* Time figure to be subtracted is pre-registered in GP7 (Set 00h 00m 00s 01f in GP7).

F0 7F <device ID> 06 <subtract = 4E> <count> <destination = 0C (GP4)> <source#1 = 0C (GP4)> <source #2 = 0F (GP7)>F7

Data Type

<loop op.mode>	12=stop Indicates the next operating mode following locating to the start point (GP3) upon arriving at the end point (GP6) by the play mode. In VR800, 12=stop only is effective.
<post locate mode>	12=stop 15=play Specifies operating mode in which VR800 should enter upon completing the locate operation. Corresponds to the setting of AUTO PLAY ON ("15")/OFF ("12") on the main unit.
<count>	01 ~ 7F Specifies succeeding data byte numbers.
<mmc track>	Complies to the MMC (MIDI Machine Control) standard track bit map. In VR800, you always need to specify two byte combinations of "r0" and "r1."
<edit message>	00 = no message 01 = completed (completion flag) 02 = active (execution flag) 02<mmc time> = Indicates unprocessed time by active (execution flag) and <mmc time>. 02<count><mmc track> = Indicates source track by active (execution flag) and <mmc track>. Used for clipboard play. 03 = cancel (execution stop) 05 = Indicates rehearsal (rehearsal mode of auto rec). Possible of undo. 06 = Indicates take (take mode of auto rec). Possible of undo. 10 = over value error 10 <mmc time> = Capacity shortage time is indicated by over value error (error by capacity shortage) and <mmc time>. In copy paste, it indicates capacity shortage time required for a minimum one time paste. 11 = Indicates in point error (incorrect in point). 12 = Indicates out point error (incorrect out point). 14 = Indicates void data (data necessary for paste does not exist). 18 = Indicates track select error (track necessary to execute copy/move or erase/cut is not correctly setup). 19<repeat count> = Indicates repeat number error and repeat numbers executable by <repeat count>. 1A = Indicates disable rec (record disable mode). 25 = Indicates can't undo rehearsal (rehearsal mode of auto rec). Impossible to undo. 26 = Indicates can't undo take (take mode of auto rec). Impossible to undo. 71 = Indicates on. 72 = Indicates off.
<mmc time>	hr mn sc fr {ff/st} complies to the MMC standard time code.
<on/off>	70 = default 71 = on 72 = off
<repeat count>	01 ~ 7F Especially when executing commands such as paste, the number of pasting times to be continuously repeated following the auto punch in point is specified.
<channel>	00 ~ 08, 7F Select recorder tracks 1~8. "00" in particular, is not specified (default setting). "7F" indicates input/output of Adat optical. For details, refer to explanation on setting the Command/Mode.
<lock enable>	00 = lock disable, chase disable 01 = lock enable, chase enable Corresponds to SLAVE ON ("01")/OFF ("00") in the main unit.
<lock status>	00 = lock disable, chase disable 01 = lock enable (unlocked), chase enable (unlocked) 11 = lock enable (locked), chase enable (locked)
<program>	01 ~ 7F Indicates program numbers (P1 ~ P99) on the main unit. However, VR800 can specify only 01 (corresponds to P01) ~ 63H (corresponds to P99).
<lock mode>	40 = Free 42 = Vari Indicates the slave mode when this equipment is set to slave ON.

<signature map>	<p>bar2, bar1, bar0, sign, sigd bar2: The 100th digit of the bar figure is expressed in BCD. bar1: The 10th digit of the bar figure is expressed in BCD. bar0: The 1 digit of the bar figure is expressed in BCD. sign: Numerator of the signature to be set is expressed in BCD. sigd: Denominator of the signature to be set is expressed in BCD. When specified as sign=00 and sigd=00, signature data of that bar position will be deleted. Also, bar2=bar1=bar0=sign=sigd=00 indicates "no corresponding data" (such as when a figure specified by <event number> do not exist at receiving the signature map request).</p>
<tempo set map>	<p>bar2, bar1, bar0, beat, tmp2, tmp1, tmp0 bar2: The 100th digit of the bar figure is expressed in BCD. bar1: The 10th digit of the bar figure is expressed in BCD. bar0: The 1 digit of the bar figure is expressed in BCD. beat: The beat figure is expressed in BCD. tmp2: Numerator of the tempo to be set is expressed in BCD. tmp1: Denominator of the tempo to be set is expressed in BCD. tmp0: The 1 digit of the tempo is expressed in BCD. When specified as tmp2=tmp1=tmp0=00, tempo data of that bar and meter position will be deleted. Also, bar2=bar1=bar0=sign=sigd=00 indicates "no corresponding data" (such as when a figure specified by <event number> do not exist at receiving the signature map request).</p>
<event number>	<p>When one data registered by <signature map> and <tempo set map> is declared as one event, the number of events from head of the tune (the umpteenth event counted from head of the tune) must be specified. <event number="00"> is the first event.</p>
<midi sync>	<p>00: OFF 01: CLK (MIDI CLOCK) 02: MTC This corresponds to "MIDI SYNC OUT setting" of the SETUP menu.</p>
<vari data>	<p>Will be composed of two bytes (Q, P). Q: 0qqqqqqq (binary) -> <vari data> = "qqqqqqpppppppp" A 14 bit data of X0.1 P: 0qqqqqqq (binary) attached with a minus symbol. Vari-pitch must be specified, at +0.1% when MSB (q)=0 (Example: 0000000000001), and at -0.1% when MSB (q)=1 (Example: 1111111111111).</p>
<frame rate>	<p>00: 30nd 01: 25 02: 24 03: 30df Corresponds to selecting "FRAME RATE setting" of the SETUP menu.</p>
<MTC offset mode>	<p>00: ABS 01: signature Corresponds to selecting "MTC OFFSET MODE" of the SETUP menu.</p>
<time base>	<p>00: ABS 01: BAR BEAT 02: MTC Corresponds to selecting "Time Base select".</p>
<level data>	<p>t1, t2 tn n: Indicates the track number. tn: Indicates absolute 8 bits of the Audio 16 bit data (Range: 00 ~ 7F).</p>

Explanation on the Command/Mode Set

12 22 (<on/off>): loop on/off command

The command for setting the "loop mode on/off" (=ON/OFF of AUTO RTN) of VR800. Default figure of the loop operation mode is "12=stop" and this cannot be changed.

12 28 (<post locate mode>): post locate command

The command for setting the "post locate mode" (=ON/OFF of AUTO PLAY) of VR800. It will stop after locating if "post locate mode=12." It will enter play after locating if "post locate mode=15."

12 2D (<on/off>): auto rec command

The command for setting "auto rec mode on/off" (=ON/OFF of AUTO PUNCH) of VR800. Upon receiving this command, VR800 will immediately reply the operating condition by sending "32 2D (<edit message>)".

12 41 (<lock enable>): lock enable command

The command for setting "slave mode on/off" (setup menu) of VR800.

12 42 (<lock mode>): lock mode command

The command for setup of the slave mode (setup menu) when this equipment is set to "slave mode on."

12 45 (<count><mmc track>) : copy clip command

When this command is received, VR800 will copy (multiple number of tracks can be copied simultaneously) the sound data, as data for copy paste, from the pre-registered clipboard-in point to the clipboard-out point in the track specified by <mmc track>. With completion of copying the data into the clipboard, VR800 will immediately reply with "32 45 (<edit message=01 (completed)>)". If copy cannot be executed due to improper figures of the pre-registered clipboard in/clipboard out points or incorrect track section, the corresponding <edit message> will be returned.

12 46 (<count=01><repeat count>): copy paste command

12 46 (<count><repeat count><mmc track>): copy paste command

When this command is received, VR800 will paste the sound data which has been copied into the clipboard, on the same track from the pre-registered auto punch in point as the starting point for the number of time specified by <repeat count>. However, if the sound data length in the clipboard is less than 10ms, the specifying the <repeat count> will be limited to "01." Also, by specifying <mmc track>, paste can be executed on other tracks in mono (in one track units) or stereo units (in combinations of tracks 1-2, 3-4, 5-6, 7-8).

Since time corresponding to length of the copy clipped sound data is required to complete the copy paste operation, VR800 immediately replies with "32 46 (<edit message=02 (active)>)" after receiving the command.

Successively upon completing the paste operation, "32 46 (<edit message=01 (completed)>)" is transmitted.

If paste cannot be executed due to improper figures of the pre-registered auto punch in point, insufficient disc capacity, no sound data in the clipboard, etc., the corresponding <edit message> will be replied.

12 47 (<count><mmc track>): erase command

When this command is received, VR800 will erase the data (writes in "0" data) in the section from the pre-registered auto punch in point through auto punch out point in the track specified by <mmc track>. Since time corresponding to length of the erase section is required to complete the erase operation, VR800 will immediately reply by "32 47 (<edit message=02 (active)>)" after receiving the command.

After the completion of erase operation, "32 47 (<edit message=01 (completed)>)" will be transmitted.

If erase cannot be executed due to improper figures of the pre-registered auto punch in point/auto punch out point, incorrect track section, etc., the corresponding <edit message> will be replied.

12 49: clipboard play command

When this command is received, VR800 will playback once from the head of the sound data copied in the clipboard by the copy clip and move clip commands.

Immediately after receiving the command, VR800 will reply with "32 49 (<edit message=02 (active)><count><mmc track>)." The sound data track number is indicated by (mmc track).

Upon completion of playback, "32 49 (<edit message=01 (completed)>)" is sent and clipboard play is ended. If there is no sound data in the clipboard, "32 49 (<edit message=14 (void data)>)" will be sent and clipboard play operation will be interrupted.

12 4A: undo command

Upon receiving this command, VR800 will revert to the condition prior to editing copy paste, erase, move paste, cut, redo operation. With completion of undo operation, VR800 will reply with "32 4A (<edit message=01 (completed)>)." If VR800 is not possible to undo, "32 4A (<edit message=00 (no message)>)" will be replied.

12 4B: redo command

When this command is received, VR800 will return to the condition prior to undo operation.

With completion of redo operation, VR800 will reply with "32 4B (<edit message=01 (completed)>)." If VR800 is not possible to redo, "32 4B (<edit message=00 (no message)>)" will be replied.

12 4D (<count><mmc track>): move clip command

When this command is received, VR800 will copy (multiple tracks can be copied simultaneously) the sound data from the pre-registered clipboard in point to the clipboard out point, as data for move paste operation. With completion copying the data into the clipboard, VR800 will immediately reply with "32 4D (<edit message=01 (completed)>)." If copy cannot be executed by the reason of pre-registered improper clipboard in/clipboard out point figures or incorrect track section, etc., the corresponding <edit message> will be replied.

12 4E (<count=01><repeat count>): move paste command

12 4E (<count><repeat count><mmc track>): move paste command

When this command is received, VR800 will paste the sound data which have been move clipped in the clipboard, for the number of times specified by <repeat count> on the same track from the pre-registered auto punch in point as the starting point. At the same time, the move clipped original sound data

will be erased (data "0" is written in). However, when sound data length in the clipboard is less than 10ms, specifying the <repeat count> will be limited to "01."

Also, by specifying the <mmc track>, paste operation can be executed on other tracks in mono (one track unit) or stereo units (tracks 1-2, 3-4, 5-6, 7-8).

Since time corresponding to length of the move clipped sound data is required to complete the move paste operation, VR800 will immediately reply with "32 4E (<edit message=02 (active)>)" after receiving the command.

Following completion of the move paste operation, "32 4E (<edit message = 01 (completed)>)" will be sent.

If paste cannot be executed due to improper figures of the previously registered auto punch in point, insufficient disc capacity, no sound data is in the clipboard, etc., the corresponding <edit message> will be replied.

12 4F (<channel><channel>): track exchange command (Exclusive command for FDMS-3.)

When the VR800 receives this command, the track can be exchange between the specified <channel><channel>. Especially, if the first <channel=00><channel=01>, then exchange by grouping will be executed between channel 1-8 and channel 17-24, and if the next byte <channel=00><channel=02>, then the exchange will be between channel 9-16 and channel 17-24. If it cannot be executed for some reason, an error message will be sent back.

13 3E: product new program command (Exclusive command for FDMS-3.)

When the VR800 receives this command, a new program is compiled and the current program is transferred to the new program. As compilation of the new program is comparatively short time, it is replied with "33 3E (<edit message=01 (completed)>)" immediately upon completion of execution.

If it cannot be executed for some reason, an error message will be sent back.

13 3F: delete current program command (Exclusive command for FDMS-3.)

When the VR800 receives this command, the current program is deleted and succeeding programs moved up and renumbered. If the deleted program is the only tune existing in the track, a new program will be made automatically.

As this delete current program is executed in a comparatively short time, "33 3F (<edit message=01 (completed)>)" will be sent back immediately upon completing the execution.

If it cannot be executed for some reason, an error message will be sent back.

13 41 (<channel><channel>): digital in ch.select command

The audio signal input from SPDIF digital in to assigned to the destination track specified by <channel>. The first <channel> shown in the command is the SPDIF L channel input, and the second <channel> the R channel input. "<channel=00>" indicates the adat input.

13 41 (<channel=7F><count><mmc track>): Adat in select command

Channel = 7F indicates that it is Adat In. Normally, it will be "<count=0>" and all channels will be inputs from Adat In.

If <count=0><mmc track> is indicates, then only the tracks selected will be Adat In inputs.

13 42 (<channel><channel>): digital out ch.select command

The source channel for digital out is selected.

Normally, the first <channel> shown will be the SPDIF L channel data, and the second <channel> the SPDIF R channel output. By FDMS-3 (VR800), any channel within "1 ~ 8" can be selected. "<channel=00> <channel =00>" indicates the adat output.

13 42 (<channel=7F><channel=0>): Adat out select command

In a device which can be switched between SPDIF and Adat, if the first display is <channel=7F>, then Adat Out can be setup.

13 43 (<program>): program change command

The command for PROGRAM CHANGE of VR800. The present program number can be changed to the figure indicated by <program>.

13 44 (<on/off>): click on/off command

The command for setting the metronome on/off of VR800. When ON is set, the metronome signal will be fed to the track 8 output of VR800.

13 46 (<on/off>): Bar/Beat Resolution ON/OFF command

The command for ON/OFF of the bar/beat resolution function of this equipments' current program.

13 47 (<midi sync>): Midi Sync Out command

The setup command for MIDI Sync Out mode of this equipments' current program.

13 48 (<MTC offset mode>): MTC offset mode command

The setup command for MTC offset mode of this equipments' current program.

13 49 (<count=3> <on/off> <vari data>): Vari pitch command

13 49 (<count=1> <on/off>): Vari pitch command

The command for setting this equipments' vari pitch ON/OFF and pitch data.

Control of ON/OFF only is possible at <count=1> and both ON/OFF and pitch data can be set at <count=3>.

14 01 (<signature map>): Signature set command

The command for setting the meter of this equipment. If a new data is registered at the bar position where a data exists, the former data will be written over. When this command is received, this equipment will reply with "34 01 (<edit message>)." Upon completing the registration, <edit message> will reply with "01 (completed)," or with "10 (over value error)" if registration is attempted at a non-existing point or an erroneous figure is used.

14 02 (<tempo set map>): Tempo set command

The command for tempo set of this equipment. If a new data is registered in a bar/meter where data already exists, the former data will be written over. When this command is received, this equipment will reply with "34 02 (<edit message>)." Upon completing the registration, <edit message> will reply with "01 (completed)," or with "10 (over value error)" if registration is attempted at a non-existing point or an erroneous figure is used.

14 03 : Tempo map all erase command

When this command is received, this equipment will erase all meter and tempo data in the current program and thus return it to the default state (meter=4/4, tempo: ♩=120). Also, when this command is received, this equipment will reply with "34 03 (<edit message>)." Upon completing the registration, <edit message> will reply with "01 (completed)," or with "10 (over value error)" if registration is attempted at a non-existing point or an erroneous figure is used.

14 04 (<mmc time>): Preroll time set command

The command for setting the current program preroll time at the figure indicated by <mmc time>.

14 06 (<frame rate>): Frame rate set command

The command for setting the current program frame rate at the figure indicated by <frame rate>.

14 08 (<time base>): Time base set command

The command for setting the current program time base of this equipment to that indicated by <time base>.

The Status Request Command

22 21: loop operation status request

The command inquiring the loop operation mode setup status. VR800 will reply with "32 21 (<loop op.mode=12>)."

22 22: loop on/off status request

The command inquiring the loop on/off (=ON/OFF of AUTO RETURN) setup status. VR800 will reply with "32 22 (<on/off>)."

22 28: post locate status request

The command inquiring the post locate mode (ON/OFF of AUTO PLAY) setup status. VR800 will reply with "32 28 (<post locate mode>)."

22 2D: auto rec status request

The command inquiring the auto rec mode setup status and this is replied by "32 2D (<edit message>)." Reply from VR800 against this status request will be either one of the following:

- <edit message> =05: Possible to undo rehearsal mode.
- =06: Possible to undo take mode.
- =25: Unpossible to undo rehearsal mode.
- =26: Unpossible to undo take.
- =72: off

22 41: lock status request

The command inquiring the slave on/off setup status and the lock status. VR800 will reply with "32 41 (<lock status>)."

22 42 : lock mode status request

The command for inquiring the lock mode setup status and this is replied with "32 42 <lock mode>."

22 45: copy clip status request

The command inquiring the clipboard condition. If there is a copy paste data in the clipboard, VR800 will reply with "32 45 (<edit message=01>)." If data in the clipboard is for move paste or there is no valid data in it, it will reply will "32 45

(<edit message=14 (void data)>)."

22 46: copy paste status request

The command inquiring execution status of copy paste editing. When this command is received, VR800 will reply with either "32 46 (<edit message=02><mmc time>)" or "32 46 (<edit message=00>)." <mmc time> indicates unprocessed time until completion.

22 47: erase status request

The command inquiring execution status of erase. When this command is received, VR800 will reply by either "32 47 (<edit message=02><mmc time>)" or "32 47 (<edit message=00>)." <mmc time> indicates unprocessed time until completion.

22 4D: move clip status request

The command inquiring the clipboard status. If there is a move paste data on the clipboard, VR800 will reply with "32 4D (<edit message=01>)." If data in the clipboard is for copy paste or there is no valid data on it, "32 4D (<edit message=14 (void data)>)" will be replied.

22 4E: move paste status request

The command inquiring the move paste execution status. When this command is received, VR800 will reply with "32 4E (<edit message=02><mmc time>)" or "32 4E (<edit message=00>)." <mmc time> indicates unprocessed time until completion.

23 41: digital in channel status request

23 41: adat in channel status request

The command inquiring the digital in channel setup status. When this command is received, VR800 will reply with "33 41 (<channel><channel>)" or "33 41 (<channel=7F><count><mmc track>)."

23 42: digital out channel status request

23 42: adat out channel status request

The inquiring the digital out channel setup status. When this command is received, VR800 will reply with "33 42 (<channel><channel>)" or "33 42 (<channel=7F><channel=0>)."

23 43: program status request

The command inquiring the presently operating program number. When this command is received, VR800 will reply with "33 43 (<program>)."

23 44: click on/off status request

The command inquiring the metronome on/off status of VR800. When this command is received, VR800 will reply with "33 44 (<on/off>)."

23 45: level status request

The command inquiring the present output level data of the 1~8 tracks. In VR800 as the level data is updated about every 40msec., inquiry in 40msec. units is effective. When this command is received, VR800 will reply with "33 45 (<count=10><level data>)."

23 46: resolution status request

The command for inquiring the resolution on/off setup status.

When this command is received, this equipment replies with "33 46 <on/off>."

23 47: midi sync out status request

The command for inquiring on status of the midi sync out setup condition. When this command is received, this equipment replies with "33 47 <midi sync>."

23 48: MTC offset mode status request

The command for inquiring the MTC offset mode setup status. When this command is received, this equipment replies with "33 48 <MTC offset mode>."

23 49: vari pitch status request

The command for inquiring status of vari pitch on/off and vari pitch data. When this command is received, this equipment replies with "33 49 (<count=3> <on/off> <vari data>)."

24 01 (<event number>): signature map request

The command for inquiring the meter setup. Order number counting from the leading tune must be specified in the event number (The first event is expressed as "event number=00." When this command is received, this equipment replies with "34 01(<signature map>)."

24 02 (<event number>): Tempo set map request

The command for inquiring tempo data. Order number from the leading tune must be specified in the event number (The first event is expressed as "event number=00." When this command is received, this equipment replies with "34 02 (<tempo set map>)."

24 04: preroll time status request

The command for inquiring the preroll time setup status. When this command is received, this equipment replies with "34 04 (<mmc time>)."

24 05: remain time request

The command for inquiring the disk remaining time which is recordable. When this command is received, this equipment replies with "34 05 (<mmc time>)."

24 06: frame rate status request

The command for inquiring the frame rate setup status. When this command is received, this equipment replies with "34 06 (<frame rate>)."

24 08: time base status

The command for inquiring the setup status of the time base shown in the display. When this command is received, this equipment replies with "3408 (<time base>)."

Explanation on the Status Reply

32 21 (<loop op.mode>): loop operation mode status reply

This is the reply against the "22 21" loop operation status request command. <loop op.mode=12> is the only status data of VR800 and any other setting is not permissible.

32 22 (<on/off>): loop on/off status reply

This is the reply against "22 22" loop on/off status request.

32 28 (<post locate mode>): post locate mode status reply

This is the reply against "22 28" post locate status request. <post locate mode=12 or 15> is the only status data of VR800 and any other setting is not permissible.

32 2D (<edit message>): auto rec status reply

This is the reply against the "12 2D" auto rec command or the "22 2D" auto rec status request.

32 41 (<lock status>): lock status reply

This is the reply against the "22 41" lock status request.

32 42 (<lock mode>): lock mode status reply

This the reply against the "22 42" lock mode status request.

32 45 (<edit message>): copy clip status reply

This is the reply against the "12 45" copy clip command or the "22 45" copy clip status request.

32 46 (<edit message>): copy paste status reply

32 46 (<edit message><mmc time>): copy paste status reply
This is the reply against the "12 46" copy paste command or the "22 46" copy paste status request. <mmc time> indicates the unprocessed time until completion of copy paste editing.

32 47 (<edit message>): erase status reply

32 47 (<edit message><mmc time>): erase status reply

This is the reply against "12 47" erase command or "22 47" erase status request.

32 49 (<edit message><count><mmc track>): clipboard play status reply

This is the reply against the "12 49" clipboard play command. If there is no sound data in the clipboard, "32 49"(<edit message=14 (void data)>)" will be replied. <mmc track> indicates the sound data track number.

32 4A (<edit message>): undo status reply

This is the reply against the "12 4A" undo command. Either <edit message=01 (completed) or <edit message=14 (void data)> will be replied.

32 4B (<edit message>): redo status reply

This is the reply against the "12 4B" redo command. Either <edit message=01 (completed)> or <edit message=14 (void data)> will be replied.

32 4D (<edit message>): move clip status reply

This is the reply against the "12 4D" move clip command or "22 4D" move clip status request.

32 4E (<edit message>): move paste status reply

32 4E (<edit message><mmc time>): move paste status reply
The reply against the "12 4E" move paste command or the "22

4E" move paste status request. <mmc time> indicates the unprocessed time until completion of move paste editing.

32 4F (<edit message>): track exchange status reply

This is the reply against the "12 4F" track exchange command.

33 3E (<edit message>): product new program status reply

This is the reply against the "13 3E" product new program command.

33 41 (<channel> <channel>): digital in channel status reply

33 41 (<channel=7F> <count> <mmc track>): adat in status reply

This is the reply against the "23 41" digital in ch. st. request. The first <channel> indicates the track number assigned to the L channel of the digital audio signal (S/P DIF) from the DATA IN connector, and the second <channel> the track number assigned to the R channel. If digital in is set to "Adat," the reply for the first <channel> will be 7F and then <count> <mmc track>, in this order. In the <mmc track>, the track bit map which is the Adat input, is expressed by "1" (In this equipment, the reply will all be "1", or in other words, all tracks will be collectively converted to Adat inputs or analog inputs).

33 42 (<channel> <channel>): digital out channel status reply

33 42 (<channel=7F> <channel=00>): adat out status reply

This is the reply against the "23 42" digital out ch. st. request. The first <channel> indicates the track number assigned to the L channel output of the digital audio signal (S/P DIF) from the DATA OUT connector, and the second <channel> the track number as signed to the R channel output. If digital out is set to "Adat," the reply for the first <channel> will be 7F and that for the second <channel> will be 00.

33 43 (<program>): program status reply

This is the reply against the "23 43" program status request. <program> indicates the presently operating program number.

33 44 (<on/off>): click status reply

This is the reply against the "23 44" click status request. It indicates the on/off setting of the metronome function.

33 45 (<count=10><level data>): level status reply

This is the reply against the "23 45" level status request and it indicates the present track 1-16 output level data. In VR800, as level data is updated 40msec., it will be effective if inquiry is made in 40msec. units.

33 46 (<on/off>): bar/beat resolution status reply

This is the reply against "23 46" bar/beat resolution status request.

33 47 (<midi sync>): midi sync out status reply

This is the reply against "23 47" midi sync out status request.

33 48 (<MTC offset mode>): MTC offset mode status reply

This is the reply against "23 48" MTC offset mode status request.

33 49 (<count=3> <on/off> <vari data>): vari pitch status reply

This is the reply against "23 49" vari pitch status request and is indicating the vari pitch function on/off and the present vari pitch setup figure.

34 01 (<signature map>): signature map status reply

This is the reply against "24 01" (<event number>) signature map request. The signature map of the event indicated by the <event number> is replied. If there is no event specified (Example: Such as when <event number=5> is requested even though there is only 5 meters registered), it will be replied with all figures at 00 of the <signature map>.

34 02 (<tempo set map>): tempo set map status reply

The reply against "24 02" (<event number>) tempo set map request. Tempo set map of the event indicated by the <event number> is replied. If there is no event specified (Example: Such as when <event number=20> is requested although only 10 is setup for tempo), it will be replied with all figures at 00 of the <signature map>.

34 04 (<mmc time>): preroll set map status reply

This is the reply against "34 04" preroll time status request and this is replied with the presently set preroll time.

34 05 (<mmc time>): remain time reply

This is the reply against "24 05" remain time request, and is replied with the recordable disc remaining time.

34 06 (<frame rate>): frame rate status reply

This is the reply against "24 06" frame rate status request, and is replied with the presently set frame rate.

34 08 (<time base>): time base status reply

This is the reply against "24 08" time base status request, and is replied with the presently set time base (in the display).

Maintenance

Cleaning the exterior

* For normal cleaning, use a soft dry cloth.

For stubborn dirt, moisten a cloth in diluted detergent, wring it out firmly, and wipe the dirt off. Then polish with a dry cloth. Never use solvents such as alcohol, thinner or benzene, since these will damage the printing and finish of the exterior.

Specifications

Input/Output

<DATA IN/OUT>

Connector : Optical (X 2)
 Format : (1) IEC 60958 (S/P DIF)
 : (2) Alesis Proprietary Multi
 Channel Optical Interface (Adat
 optical)
 (Either (1) or (2) is selected in the
 Setup mode.)

<MIDI IN/OUT>

Connector : DIN 5PIN (X 2)
 Format : MIDI standard

<SCSI>

Connector :D-sub 25 pin (X1)
 Protocol : SCSI-2, unbalanced transmission
 format
 Transmission format : Asynchronous transmission
 Units connected : Two
 SCSI-ID : Automatic recognition

<WORD OUT>

Connector : BNC (X 1)
 Output level : TTL level
 Load impedance : 75Ω

<PUNCH IN/OUT>

Connector : ø6mm Phone jack (X 1)
 (An optional FOOT SW Model 8051
 can be connected.)

Recording/Reproducing

<Recording medium>

:3.5 inch, hard disk (E-IDE type)
 :External SCSI device (SCSI-2, unbalanced
 transmission format)

<Recording format>

: FDMS-3*

<Recording mode>

:ADAC 8ch mode:
 8 real tracks+16 additional tracks
 (44.1kHz/A.D.A.C.)
 :Master 8ch mode:
 8 real tracks+16 additional tracks
 (44.1kHz/16bit linear)

:Master 4ch mode:
 4 real tracks+20 additional tracks
 (44.1kHz/16bit linear)

<Save/Load format>

:ADAC 8ch mode: SCSI
 :Master 8ch mode: FDIO-1 (DAT, adat), SCSI
 :Master 4ch mode: SCSI, FDIO-1 (DAT)

<A/D> : 20-bit 64-time, over sampling, Delta-Sigma
 <D/A> : 20-bit 128-time, over sampling, Delta-Sigma

<Program No.> : maximum 99 tunes

<Simultaneous playback tracks>

:8 tracks (Master 8ch/ADAC 8ch mode)
 :4 tracks (Master 4ch mode)

<Vari Pitch> : +/-6%

<Digital In/Out> : 44.1kHz/16bit linear

General

Dimensions : 254 (W) X 100 (H) X 285 (D) mm
 * Including highest protrusion.

Weight : approx. 2.0kg

Power supply : 120VAC 60Hz
 : 230V~ 50/60Hz

Power consumption : approx. 15W

* Specifications and appearance are subject to change
 without notice for product improvement.

* "Adat" and the  symbol are trademarks of Alesis
 Corporation.

* FDMS-3: Fostex Disk Management System-3.

* FDIO-1 Ver.2: Fostex Data In Out-1 Ver.2

Declaration of EC Directive

This equipment is compatible with the EMC Directive (89/336/EEC) - Directive on approximation of member nation's ordinance concerning the electromagnetic compatibility and with the Low Voltage Directive (73/23/EEC) - Directive on approximation of member nation's ordinance concerning electric equipment designed to be used within the specified voltage range.

The Affect of Immunity on This Equipment

The affect of the European Specification EN50082-1 (coexistence of electromagnetic waves - common immunity specification) on this equipment are as shown below.

* In the electrical fast transient/burst requirements, radiate electromagnetic field requirements and static electricity discharging environment, this could be affected by generation of noise in some cases.

FOSTEX DISTRIBUTORS LIST IN EUROPE

* Including non-EU countries.

* underlined: contracted distributors (as of Nov, 1997)

<AUSTRIA>

NAME: ATEC Audio-u. Videogeraete VertriebsgesmbH.
 ADD: Im Winkel 5, A-2325 Velm, Austria
 TEL: (+43) 2234-74004, FAX: (+43) 2234-74074

<BELGIUM>

NAME: EML N. V.
 ADD: Bijvenestraat 1A, B3500 Hasselt, Belgium
 TEL: (+32) 11-232355, FAX: (+32) 11-232172

<DENMARK>

NAME: SC Sound ApS
 ADD: Malervej 2, DK-2630 Taastrup, Denmark
 TEL: (+45) 4399-8877, FAX: (+45) 4399-8077

<FINLAND>

NAME: Norettron Audio
 ADD: Tonttumuorinkuja 4, FIN-02200 Espoo, Finland
 TEL: (+358) 0-5259330, FAX: (+358) 0-52593352

<FRANCE>

NAME: Musikengro
 ADD: ZAC de Follieuses, B. P. 609, 01706 Les Echets, France
 TEL: (+33) 72 26 27 00, FAX: (+33) 72 26 27 01

<GERMANY>

NAME: Studio sound & Music GmbH
 ADD: Scheppe Gewissegasse 8, D-35039 Marburg, Germany
 TEL: (+49) 6421-12071, FAX: (+49) 6421-15522

<GREECE>

NAME: Bon Studio S. A.
 ADD: 6 Zaimi Street, Exarchia, 106.83 Athens, Greece
 TEL: (+30) 1-3809605-8, 3302059, FAX: (+30) 1-3845755

<ICELAND>

NAME: I. D. elrf. electronic Ltd.
 ADD: ARMULA 38 108 REYKJAVIK, ICELAND
 TEL: (+354) 588 5010, FAX: (+354) 588 5011

<ITALY>

NAME: Recoton Italia Srl.
 ADD: V. 1 Maggio, N 18, 40050 Quarto Inferiore, (BO) Italy
 TEL: (+39) 51-768576, FAX: (+39) 51-768336

<THE NETHERLANDS>

NAME: IEMKE ROOS AUDIO B. V.
 ADD: Kuiperbergweg 20, 1101 AG Amsterdam, The Netherlands
 TEL: (+31) 20-697-2121, FAX: (+31) 20-697-4201

<NORWAY>

NAME: Siv. Ing. Benum A/S
 ADD: P. O. Box 145 Vinderen, 0319 Oslo 3, Norway
 TEL: (+47) 22-139900, FAX: (+47) 22-148259

<PORTUGAL>

NAME: Caius - Tecnologias Audio e Musica, Lda.
 ADD: Rua de Santa Catarina, 131 4000 Porto, Portugal
 TEL: (+351) 2-2084456/325400, FAX: (+351) 2-314760

<SPAIN>

NAME: Multitracker, S. A.
 ADD: C/Garcilaso No.9, Madrid 28010, Spain
 TEL: (+34) 1-4470700, 1-4470898, FAX: (+34) 1-5930716

<SWEDEN>

NAME: TTS Tal & Ton Studioteknik AB
 ADD: Gelbgjutarevagen 4, S-171 48 Solna, Sweden
 TEL: (+46) 8-7340750, FAX: (+46) 8-824476

<SWITZERLAND>

NAME: Audio Bauer Pro AG
 ADD: Bernerstrasse-Nord 182, CH-8064 Zurich, Switzerland
 TEL: (+41) 1-4323230, FAX: (+41) 1-4326558

<UK>

NAME: SCV London
 ADD: 3A 6-24 Southgate Road, London N1 3JJ, England, UK
 TEL: (+44) 171-923-1892, FAX: (+44) 171-241-3644

INDEX

[A]	[F]
ACCESS LED.....8	F FWD button.....11
AUTO RTN/AUTO PLAY key.....10	Formatting a current drive.....28
AUTO RTN END key.....13	Formatting a backup disk.....30
AUTO RTN START key.....13	Foot switch.....40
AUTO PUNCH IN key.....13	Fade-in preview.....59
AUTO PUNCH OUT key.....13	Fade-out preview.....59
AC IN connector.....15	Fostex System Exclusive message.....108
Acc Error message.....19	
Additional Track.....23	[H]
Audio File.....25	HOLD/> key.....12
A. D. A. C.....27	
ADAC 8ch mode.....27	[I]
Auto punch in/out take.....39	Input Monitoring.....24
Auto play function.....55	Illegal FM message.....87
Auto return function.....55	
Auto repeat function.....56	[J]
All Clear? message.....91	JOG dial.....10
[B]	[L]
Back up disk.....30, 78, 86	Load Err message.....19
BAR/BEAT resolution setting.....103	Locate point.....48
	Locate number.....48
[C]	Locate function.....54
Contrast adjustment knob.....9	Loading song data.....75
Clipboard in key.....9	Loading data using SCSI drive.....80
Clipboard out key.....9	Length? message.....83
Creating a new program.....32	Loading data using DAT or adat.....84
Cuing.....57	
Copy & Paste.....61	[M]
Clipboard play.....62	MIDI OUT jack.....14
Chase lock.....74	MIDI IN jack.....15
Changing the BAR value.....91	Master 8ch mode.....27
	Master 4ch mode.....27
[D]	Manual punch in/out.....40
DISP SEL key.....9	Metronome function.....43
DATA OUT jack.....14	Move & Paste.....61
DATA IN jack.....14	MIDI sync.....68
Display.....16	MTC sync/MIDI machine control.....70
Display when the power is turned on.....16	MIDI sync signal output setting.....69, 71
Deleting a program.....34	Metronome setting.....69
Direct digital recording.....45	MTC offset time.....71, 74
Direct locate.....54	MTC offset mode.....71, 72, 73
Digital-in clock.....45, 85, 101	MTC frame rate.....71, 73
Digital input track setting.....46, 101	MIDI device.....71
Digital output track setting.....47, 102	MIDI sync output signal setting.....95
	MTC frame rate setting.....96
[E]	MTC offset time setting.....96
Exit/No key.....9	MIDI device setting.....104
Execute/Yes key.....9	MIDI implementation chart.....106
EDIT key.....10	MMC command list.....107
Event.....25, 105	Maintenance.....118
Editing a program title.....35	
Editing and storing data.....50	[O]
Editing LOCATE key data.....52	Over! message.....19
Erase.....61, 64	Outline of the save/load function.....75
Event check.....105	Offset mode setting.....97

[P]			
	PLAY button.....	11	
	POWER switch.....	15	
	PUNCH IN/OUT jack.....	15, 40	
	Preset display.....	16	
	Protected message.....	19	
	Program Change.....	22, 33	
	Playback Monitoring.....	24	
	Punch In/Out recording.....	36	
	Press LOC: message.....	52	
	Preview function.....	59	
	Play DAT message.....	85	
	Position of setup menu.....	89	
	Preroll time setting.....	94	
[R]			
	Record track select key.....	8	
	REWIND button.....	11	
	RECORD button.....	12	
	Rec+Yes! message.....	19	
	Recording Method.....	21	
	REMAIN.....	18, 21	
	Real Track.....	23	
	Recording Mode.....	27	
	Re-formatting.....	29, 31	
	Rehearsing auto punch in/out.....	38	
	Review.....	57	
	Rec Start message.....	83	
	Record protect setting.....	100	
[S]			
	SETUP key.....	9	
	SCRUB key.....	10	
	SHIFT key.....	11	
	STOP button.....	11	
	STORE key.....	12	
	SCSI connector.....	14	
	Selecting time base using the DISP SEL key.....	17	
	Select TRK message.....	19, 58	
	Storing in real-time.....	49	
	Storing LOCATE key.....	51	
	SHUTTLE function.....	57	
	SCRUB function.....	58	
	Slave mode.....	73	
	Slave mode.....	74	
	Slave mode type.....	74	
	Saving song data.....	75	
	Saving data using SCSI drive.....	78	
	Saving data using DAT or adat.....	82	
	Sign. Chk message.....	90	
	Sign. Edit message.....	90	
	Slave mode setting.....	98	
	Slave type setting.....	99	
	Specifications.....	118	
	Track Over message.....	19	
	Time Base.....	20	
	Trimming the locate point.....	60	
	Track exchange.....	61, 66	
	Time signature setting.....	69, 90	
	Tempo setting.....	69, 92	
[U]			
	UNDO/REDO key.....	9	
	Unformat! message.....	19	
	Undo/Redo function.....	39, 42, 63, 65	
[V]			
	VARI PITCH key.....	11	
	Void Data message.....	19	
	Void Out message.....	19	
[W]			
	WORD OUT jack.....	15	
	Warning messages.....	19	
	Wrong Disk message.....	87	
[T]			
	TIME BASE SEL key.....	10	
	Time base selected via the TIME BASE SEL key.....	17	
	The REMAIN display.....	18	

Fostex[®]

FOSTEX CORPORATION

3-2-35 Musashino, Akishima-shi, Tokyo 196-0021, Japan

FOSTEX CORPORATION OF AMERICA

15431, Blackburn Ave., Norwalk, CA 90650, U. S. A.