

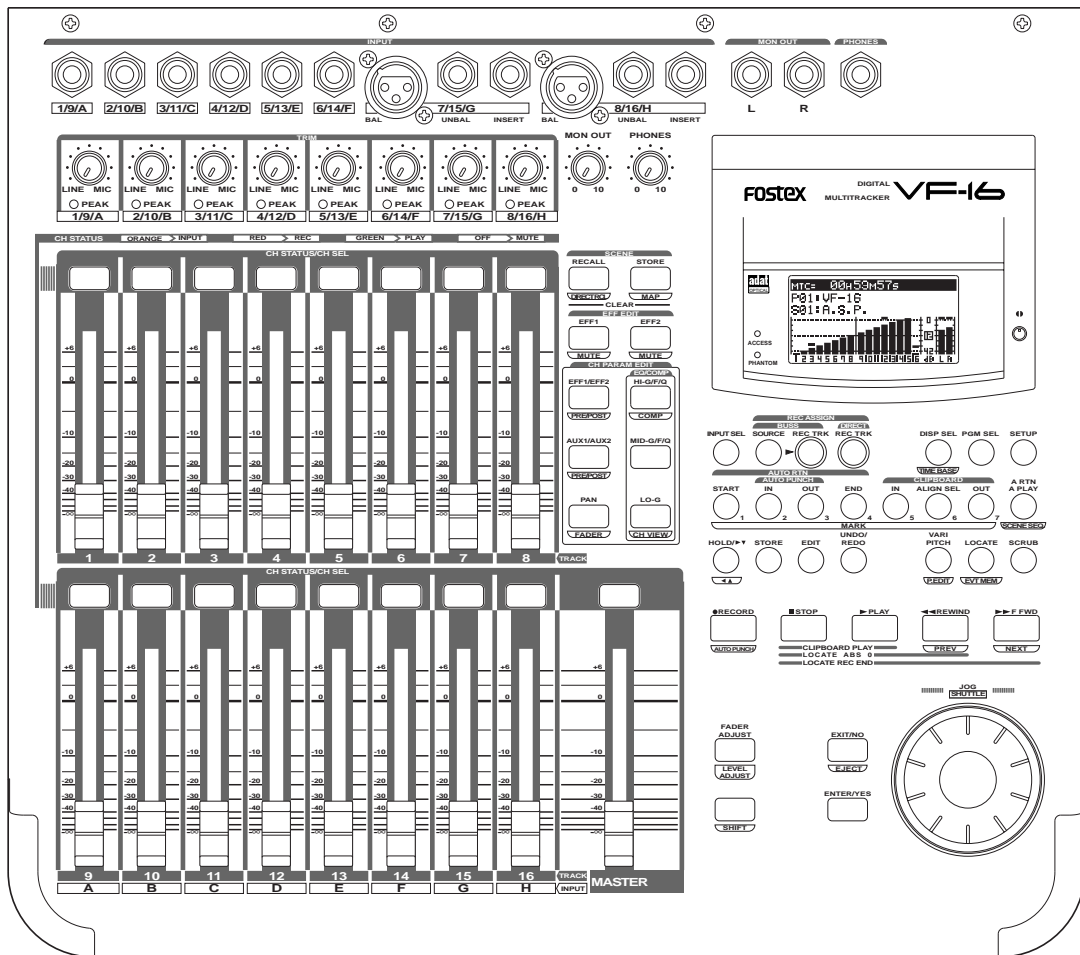

Owner's Manual

Digital Multitracker

VF-16

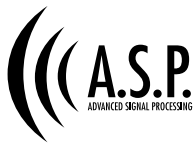

 <div style="display: inline-block; text-align: center; background-color: black; color: white; padding: 2px 10px; font-weight: bold; margin: 0 5px;">CAUTION</div> 
<p>RISK OF ELECTRIC SHOCK DO NOT OPEN</p>
<p>CAUTION: TO REDUCE THE RISK OF ELECTRIC SHOCK, DO NOT REMOVE COVER (OR BACK). NO USER - SERVICEABLE PARTS INSIDE. REFER SERVICING TO QUALIFIED SERVICE PERSONNEL.</p>

CAUTION:
TO PREVENT ELECTRIC SHOCK, MATCH WIDE BLADE OF PLUG TO WIDE SLOT, FULLY INSERT.

ATTENTION:
POUR ÉVITER LES CHOCS ÉLECTRIQUES, INTRODUIRE LA LAME LA PLUS LARGE DE LA FICHE DANS LA BORNE CORRE-SPONDANTE DE LA PRISE ET POUSSER JUSQU' AU FOND.



The lightning flash with arrowhead symbol, within an equilateral triangle, is intended to alert the user to the presence of uninsulated "dangerous voltage" within the product's enclosure that may be of sufficient magnitude to constitute a risk of electric shock to persons.



The exclamation point within an equilateral triangle is intended to alert the user to the presence of important operating and maintenance (servicing) instructions in the literature accompanying the appliance.

"WARNING"

"TO REDUCE THE RISK OF FIRE OR ELECTRIC SHOCK, DO NOT EXPOSE THIS APPLIANCE TO RAIN OR MOISTURE."

SAFETY INSTRUCTIONS

1. Read Instructions - All the safety and operating instructions should be read before the appliance is operated.
2. Retain Instructions - The safety and operating instructions should be retained for future reference.
3. Heed Warnings - All warnings on the appliance and in the operating instructions should be adhered to.
4. Follow Instructions - All operating and use instructions should be followed.
5. Water and Moisture - The appliance should not be used near water - for example, near a bathtub, washbowl, kitchen sink, laundry tub, in a wet basement, or near a swimming pool, and the like.
6. Carts and Stands - The appliance should be used only with a cart or stand that is recommended by the manufacturer.



An appliance and cart combination should be moved with care. Quick stops, excessive force, and uneven surfaces may cause the appliance and cart combination to overturn.

7. Wall or Ceiling Mounting - The appliance should be mounted to a wall or ceiling only as recommended by the manufacturer.
8. Ventilation - The appliance should be situated so that its location or position does not interfere with its proper ventilation. For example, the appliance should not be situated on a bed, sofa, rug, or similar surface that may block the ventilation openings; or, placed in a built-in installation, such as a bookcase or cabinet that may impede the flow of air through the ventilation openings.

9. Heat - The appliance should be situated away from heat sources such as radiators, heat registers, stoves, or other appliances (including amplifiers) that produce heat.
10. Power Sources - The appliance should be connected to a power supply only of the type described in the operating instructions or as marked on the appliance.
11. Grounding or Polarization - The precautions that should be taken so that the grounding or polarization means of an appliance is not defeated.
12. Power Cord Protection - Power supply cords should be routed so that they are not likely to be walked on or pinched by items placed upon or against them, paying particular attention to cords at plugs, convenience receptacles, and the point where they exit from the appliance.
13. Cleaning - The appliance should be cleaned only as recommended by the manufacturer.
14. Nonuse Periods - The power cord of the appliance should be unplugged from the outlet when left unused for a long period of time.
15. Object and Liquid Entry - Care should be taken so that objects do not fall and liquids are not spilled into the enclosure through openings.
16. Damage Requiring Service - The appliance should be serviced by qualified service personnel when:
 - A. The power supply cord or the plug has been damaged; or
 - B. Objects have fallen, or liquid has been spilled into the appliance; or
 - C. The appliance has been exposed to rain; or
 - D. The appliance does not appear to operate normally or exhibits a marked change in performance; or
 - E. The appliance has been dropped, or the enclosure damaged.
17. Servicing - The user should not attempt to service the appliance beyond that described in the operating instructions. All other servicing should be referred to qualified service personnel.

Precautions

About power supply

- * Be sure to connect the VF-16 to the power supply specified in the Specifications section of this owner's manual. Do not use an AC outlet of any other voltage.
- * Do not connect the VF-16 to the same AC outlet to which devices that could generate noise (such as a large motor or dimmer), or the devices that consume a large amount of power (such as an air conditioning system or large electric heater) are connected.
- * If you use the VF-16 in an area with a different power voltage, first consult your dealer or the nearest Fostex service station. You can use the VF-16 with a power frequency of 50Hz or 60Hz.
- * It is very dangerous to use a power cord that is frayed or damaged. In such a case, stop using the VF-16 immediately and ask your dealer to repair the cord.
- * To avoid possible electric shock and damage to the VF-16, avoid contact with water or other liquids, or do not handle the power plug while your hands are wet.
- * To prevent possible electric shock and damage to the VF-16, do not remove the main unit cover or reach the inside of the VF-16.
- * Do not let water or other liquid, or metal objects such as pins, accidentally enter the inside of the VF-16 because this may lead to electric shock or damage. Should water enter the inside of the VF-16, remove the power plug from AC outlet, and consult your dealer or the nearest FOSTEX service station.
- * To prevent damage to the VF-16, be sure to power on the connected devices first, then turn on the power to the VF-16. When you remove or connect the cables to the input/output connectors on the VF-16, make sure that the channel faders and volume controls are set to "0."
- * Before turning the power off to the VF-16, first quit setup mode and make sure that the recorder section is stopped. Especially, never attempt to turn off the power to the VF-16 while the hard disk is accessing data (the HD ACCESS LED is lit or flashing). Otherwise, not only will you lose recorded data, but you may damage the VF-16. Fostex is not responsible for the data lost during operation of the VF-16.
- * Before you change the location of the VF-16, pack the unit in the shipping carton or an impact-resistant case. Make sure that the VF-16 is kept free from external vibration or impact since the VF-16 is very sensitive to vibration.
- * Do not install the VF-16 in locations subject to the following:
 - * Extremely high or low temperature, or significant changes in temperature.
 - * Excessive humidity or dust.
 - * Excessive changes in power supply voltage.
 - * Unstable or significantly vibrating or shaking surfaces.
 - * Near a strong magnetic field (such as a TV or speaker).
- * If you move the unit from a place with an excessively low temperature to a warm place, or if you use the VF-16 in a room in which the temperature varies significantly during winter, condensation may occur on the hard disk or other parts. In such cases, leave the VF-16 for about an hour in the new location before you turn on the power.

Note on repair

- * The VF-16 does not use any parts that user can repair easily. Contact your dealer or the nearest FOSTEX service station to ask about repairs.
- * Use the packing carton designed for the VF-16 when you transport the VF-16 to the dealer for repair or return. If you have discarded the packing box, try to pack the VF-16 completely using shock absorbing materials. Fostex is not responsible for malfunction or damage due to incomplete packaging or caused during transport.

About copyrights

- * It is prohibited by law to use any part of a CD recording or video images or audio data for which copyright is possessed by a third party for commercial purposes such as contents, broadcasts, sales, or distribution-any purpose other than for your personal pleasure.

About damage

- * Fostex is not responsible for any "direct damage" or "indirect damage" caused by using the VF-16.

Table of Contents

Safety Instructions 2
 Precautions 3

Chapter 1 Basic Features of VF-16

Introduction 6
Product Features 6

Before Operating 7
 Two RECORDING Modes 7
 RECORDING System 9
 PROGRAM 9
 REMAIN Indicator 9
 CHANNEL and TRACK 9
 ADDITIONAL TRACK 9
 INPUT Monitoring and PLAYBACK Monitoring 10
 EVENT 10
 TRIM 10
 FADER 11
 [CH STATUS/CH SEL] key 11
 TIME BASE 12

Names and Functions 13
 Analog Input/Output Section 14
 Mixer Section 15
 Recorder Section 17
 Display Section 20
 Rear Panel Section 20

About the hard disk storage device 21
 Reformatting the Hard Disk 21
 Replacing a Hard Disk 22
 Formatting the New Hard Disk 24

Chapter 2 Basic Recording and Playback

Connections of Peripheral Equipment 25

LCD 27

Instructions to DIRECT Record 28
 Recording to One Track 28
 Recording to Two Track 29

Locating a mark point using a Memory key 30
 Saving on the Memory key and Mark key 31
 Direct Location of Memory key or Mark key 31
 Changing the Time Saved in the Memory key and Mark key.. 31

ABS Locate 31

Locating an Event Memory 32
 Creating an Event Memory 32
 Viewing the Event Memories 32
 Skip Locate 32

Punch In/Out 33
 Manual Punch In/Out 33
 Punch In/Out with Foot Switch 33
 Auto Punch In/Out 33

Track Exchange 34

Mixing 34
 Level Adjustment 34
 PAN Adjustment 34
 Equalizer Adjustment 35
 Effect Send Level Adjustment 35
 Modifying Effect Type 35

Mix Down 36
 Analog Mix Down 36
 Digital Mix Down 36

Instructions to Record with BUSS RECORD 37
 Recording the “H” Input Signal to Track 1 37
 Recording 8 INPUTs to Tracks 7 and 8 39

Chapter 3 Advanced Mixer Operations

The initial condition when the power is turned on 41

Operations while the Normal Display is shown 41

Channel Parameter Edit 42
 Adjusting PAN 42
 Adjusting EQ 43
 Controlling Effect Send Level 44
 Selecting Pre/Post of Effect Sends 44
 Controlling AUX Send Level 45
 Selecting Pre/Post of AUX Sends 45
 Controlling Fader Levels 46
 Setting the Compressor 46
 Channel View 47

Effect Edit Mode 48
 About the Effect Types 49
 Selecting the Effect Type 50
 Effect Parameter Settings 51
 Effect Parameter Details 51

Scene Memory 53
 Storing to a Scene Memory 53
 Recalling a Scene Memory 53
 Level Adjust 54
 Fader Adjust 54
 Direct Recall of a Scene Memory 55
 Clearing a Scene Memory 55

Scene Event Map 55
 Creating an Event Memory 55
 Creating the Scene Event Map 56
 Deleting an Event Memory 57
 Scene Sequence Mode On/Off Selection 57
 Executing the Scene Sequence 57

Chapter 4 Recorder Functions

Cueing 58
 Cueing with the [F FWD]/[REWIND] key 58
 Digital Scrubbing with the [SCRUB] key 58
 Shuttle Cueing 58

Variable Pitch Control 59

Variable Pitch Control ON/OFF	59
Setting the Speed	59
Auto Function	60
Auto Play	60
Auto Return	60
Set (Store) Start/End Point	60
Auto Repeat	60
Program	61
Creating a New Program	61
Selecting a Program	62
Erasing a Program	62
Editing a Program Title	62
Editing the Track	63
Copy & Paste and Move & Paste	64
Undo/Redo Paste	65
Erase	66
Undo/Redo Erase	67
Track Exchange	67

Chapter 5 Features Application

<i>Applications of DIRECT RECORD</i>	<i>69</i>
DIRECT RECORD while Listening to the Input signal ..	69
<i>Applications of BUSS RECORD</i>	<i>70</i>
Record by Mixing the Input Sound and Play sound ...	70
Ping-Pong RECORD	71
<i>Metronome Function</i>	<i>72</i>
<i>Digital Recording</i>	<i>73</i>
Digital Recording from an External Digital Device	73
<i>Recording 16 Tracks at the Same Time</i>	<i>74</i>
<i>MIDI Clock Sync System</i>	<i>75</i>
<i>MIDI Sync/MIDI Machine Control System</i>	<i>76</i>
<i>External MIDI equipment Sync System by the Slave Mode..</i>	<i>78</i>

Chapter 6 Save/Load of Song Data

<i>About Song Data</i>	<i>80</i>
Items that can be saved or loaded as song data	80
Notes for DAT and adat machine to be used	80
Notes for saving data using the S/P DIF or adat	80
<i>Saving data using the S/PDIF or adat digital Signal ...</i>	<i>82</i>
<i>Loading data using the S/PDIF or adat digital Signal .</i>	<i>84</i>
<i>Saving /Loading Data using SCSI</i>	<i>86</i>
<i>Save/Load a WAV File</i>	<i>92</i>

Chapter 7 SETUP Mode

<i>To enter the SETUP mode</i>	<i>99</i>
<i>Time Signature Setting</i>	<i>99</i>
New Registering of Time Signature	99
Correcting the Registered Time Signature	100
Deleting of Time Signature	100
Clearing All Time Signature data	100
Changing the Bar Offset Figure	100
<i>Setting a Tempo</i>	<i>101</i>
New Registering of Tempo	101
Correction of the Registered Tempo	102
Erasing of the Registered Tempo	102

<i>Setting the Metronome function</i>	<i>102</i>
<i>Setting a preroll value</i>	<i>103</i>
<i>Setting MIDI sync output signal</i>	<i>103</i>
<i>Setting an MTC frame rate</i>	<i>104</i>
<i>Setting an MTC offset value</i>	<i>104</i>
<i>Setting MTC offset mode</i>	<i>105</i>
<i>Setting the Slave mode</i>	<i>105</i>
<i>Setting the Slave type</i>	<i>106</i>
<i>Setting the Record Protect function</i>	<i>106</i>
<i>Setting Digital Input</i>	<i>107</i>
<i>Setting Digital Output</i>	<i>108</i>
<i>Setting BAR/BEAT Resolution mode</i>	<i>108</i>
<i>Setting the MIDI device number</i>	<i>109</i>
<i>Checking the number of track events</i>	<i>109</i>
<i>The Drive Format Information</i>	<i>110</i>
<i>Drive Setting</i>	<i>110</i>
<i>Fader Fix mode Setting</i>	<i>111</i>
<i>Fader Recall mode Setting</i>	<i>111</i>
<i>On/Off of Phantom Power Setting</i>	<i>112</i>
<i>Compressor Channel Setting</i>	<i>112</i>

Trouble Shooting

<i>Troubles at recording?</i>	<i>114</i>
<i>Troubles at Editing?</i>	<i>115</i>

Others

<i>MIDI Implementation Chart</i>	<i>116</i>
<i>MMC Command List</i>	<i>117</i>
<i>Inquiry Message List</i>	<i>117</i>
<i>Maintenance</i>	<i>118</i>
<i>Specifications</i>	<i>118</i>
<i>Block Diagram</i>	<i>120</i>
<i>Declaration of EC Directive</i>	<i>121</i>

Chapter 1 Basic Features of VF-16

Introduction

Congratulations! You have chosen a truly unique multitracking device.

The VF-16 Fostex Digital Multitracker features a myriad of high-tech functions. These include a digital mixer incorporates high-performance DSP multi-effect made possible using the Fostex-original A.S.P. (Fostex Advanced Signal Processing) technology, as well as an integrated 16-track (+8 additional tracks) digital recorder that can record or play uncompressed 44.1kHz/16 bit high quality sound.

Please read the entire User's Manual to ensure safe and proper use of your recorder.

Product Features

Mixer Section

- * Standard high performance DSP multi-effects with A.S.P. Fostex Advanced Signal Processing technology.
- * Intuitive control of all signals with 16-input and stereo master fader.
- * All input channels come with channel ON/OFF switch, 3-band equalizer, PRE/POST switchable 2-channel EFF/AUX send.
- * All 8 channel analog inputs come with built-in trim. Mic to line level compatibility.
- * Analog channel input 7 and 8 come with phones connector and XLR connector for phantom power. Built-in insert terminals.
- * 2 Record Assigns: DIRECT Rec to simultaneously record 8 analog channels and REC BUS Rec for ping-pong recording. 16-track simultaneous recording of adat digital signals in DIRECT Rec.
- * Built-in Scene Memory function to set fader/effect setting and to program/search up to a maximum of 99 mixer modes.
- * Output mixed-down signals as S/P DIF digital signals and digital record with DAT and other external digital recorders.

Recorder Section

- * Employs the FDMS-3 (Fostex Disk Management System-3) Fostex format. 16-track (plus 8 additional tracks) REC/PLAY with high quality uncompressed 16 bit/44.1kHz sound. Roughly 3 hour recording per 1GB in mono-track.
- * Nondestructive voice editing of copy/paste, move/paste, erase, and undo/redo features as expected from a digital recorder.
- * PROGRAM feature names musical pieces and manage up to a maximum of 99 titles.
- * +/-6% pitch control.
- * CD S/P DIF or adat digital signal direct digital recording.
- * Auto punch IN/OUT with rehearsal function set in 1/100 frame units. Foot switch for manual punch IN/OUT.

Others

- * Dot matrix LCD and auto-illuminating keys. Graphic display of mixer and recorder settings/modes.
- * 3.5-inch E-IDE hard disk compatibility.
- * Standard SCSI terminal to connect external SCSI equipment. Save/load all VF-16 data (recorder/mixer data), as well as read/write recorded sounds as WAVE files.
- * Save/load to S/P DIF or adat digital signal.
- * MIDI clock and song position pointer and MTC (MIDI Time Code) output.
- * MMC (MIDI Machine Control).
- * Slave program (run) from external MTC input.
- * Internal metronome function to rhythm guide recordings.
- * Bar/beat edit (cut off clock) with bar/beat resolution.
- * Six editing memory points and 7 marked points.
- * 0-10 second pre-roll time settings.

Before Operating

This section defines the contents, names and terms the user should know prior to actually operating the VF-16. Please read the overview before going any farther with your new recorder as it will save you a lot of time in the long run.

Two RECORDING Modes

The VF-16 has 2 recording modes, called REC ASSIGN.

DIRECT Recording

The first recording mode is the DIRECT REC mode. This recording mode is mainly used to:

- * Record signals that are not processed and input in A to H; and
- * Simultaneously record all signals input in A to H on separate tracks.

In this mode, the signals input in A to H are gain tuned with the TRIM knob, then directly sent to the recorder track. The tracks are recorded as shown at the input terminal. The A input signals are recorded on track 1/9. Similarly, the B input signals are recorded on track 2/10 and finally the H input signals are recorded on track 8/16.

Therefore, it is possible to easily record on all tracks by simply tuning the gain with the TRIM knob.

Note that the same signals are sent to tracks 1/9 to 8/16. Therefore, when 16 tracks are simultaneously recorded, two tracks of the same sound will each be created. In other words, only a maximum of 8 tracks can be simultaneously recorded with different sounds for input signals A to H.

By using the adat digital input it becomes possible to simultaneously record different sounds on 16 tracks. Refer to the later section for more specific instructions.

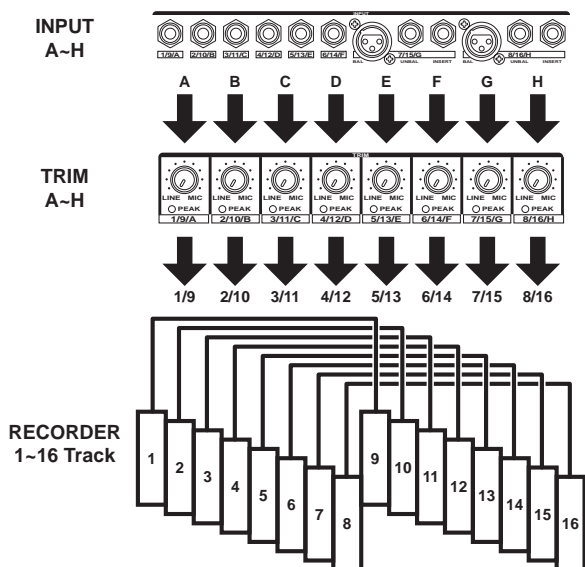

BUSS Recording

The second recording mode is the BUSS REC mode. This recording mode is mainly used to:

- * Record sounds while applying equalizer and built-in effects; and
- * Record (ping-pong recording, etc.) signals mixed on multiple channels on two or one track.

This mode is used to record signals sent to the REC BUSS, that is the recording buss, after the input signal or track play sound is processed through the mixer and level tuned or equalized. Built-in effect signals can also be sent to the REC BUSS, therefore, sounds applied with an effect can also be recorded. The channels sent to REC BUSS are called SOURCE.

The REC BUSS comes with L/R 2-channels, therefore, it is possible to simultaneously BUSS REC either 2 or 1 track.

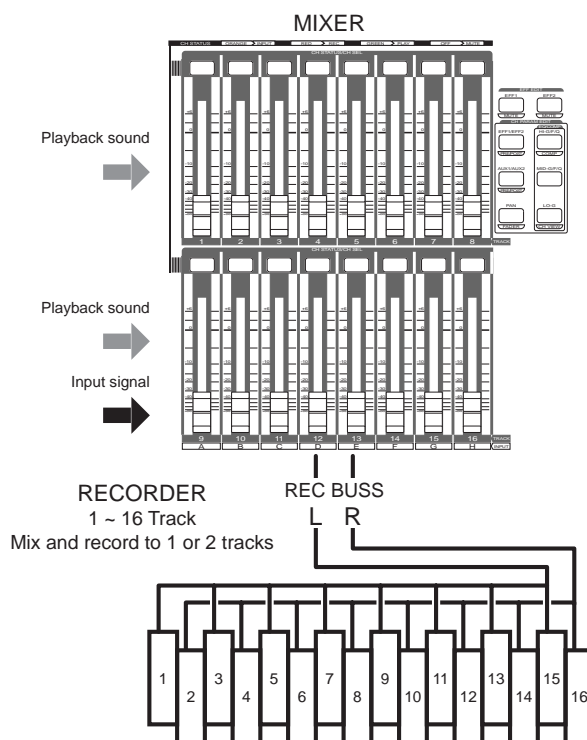

The keys below play important roles when executing DIRECT recording or BUSS recording. Please learn their functions before operating the VF-16.

[INPUT SEL] key

This key is used to determine whether signals to be input to tracks Ch1-Ch16 should be the recorder output (TRACK) or the input signal (INPUT). When this key is pressed, the display shown below will be shown to enable selection of "TRACK" or "INPUT." This display will always appear when the [INPUT SEL] key is pressed after switch ON of power to indicate that it is set for input of recorder output to Ch1-Ch16. DIRECT recording is normally executed under this setting.

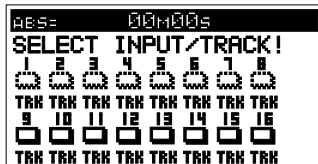

The Ch9-Ch16 icons can be changed and when the [CH STATUS/CH SEL] key for these tracks are pressed, it will alternately switch between "TRK" and "INPUT." Signals applied to input connectors (A-H) will be routed to the channel switched to "INPUT."

[DIRECT-REC TRK] key

This key is used to setup the "recording track" for DIRECT recording. When this key is pressed, the display for selecting the DIRECT recording track will appear. If any one [CH STATUS/CH SEL] key is pressed while in this display, the track for DIRECT recording will enter the READY mode. The example display below shows track 1 set to READY and that sound sources input to inputs 1/9/A can be DIRECT recorded in track 1.

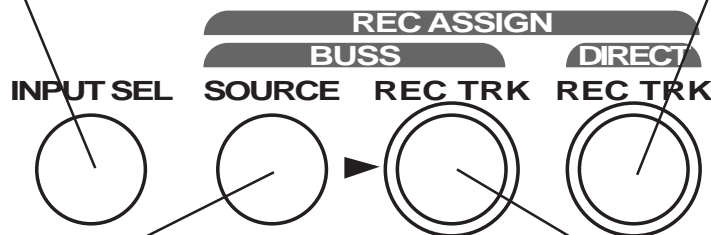
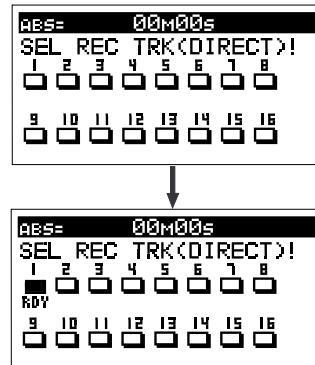

[BUSS-SOURCE] key

This key is used to select the source channel for BUSS recording. The display shown below will appear when this key is pressed and the source channel can then be selected. If the [CH STATUS/CH SEL] key is pressed under this condition, that channel will be selected for the source channel and then BUSS recorded in the track selected with the [BUSS-REC TRK] key. The display below is indicating that the input H signal in Ch16 is set as the source channel.

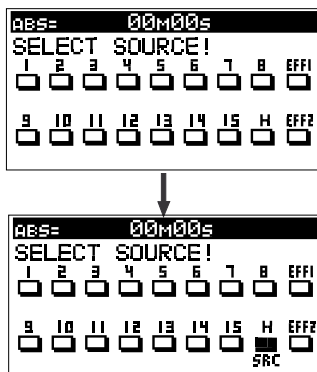

[BUSS-REC TRK] key

This key is used to select the recording track at executing BUSS recording. When this key is pressed, the example shown below will be displayed and then the BUSS recording channel can be selected. If the desired [CH STATUS/CH SEL] key is pressed, that track will be selected for the recording track and be in the READY state. The example below indicates that the input H signal in Ch16 is selected as the source channel and set for BUSS recording in track 1.

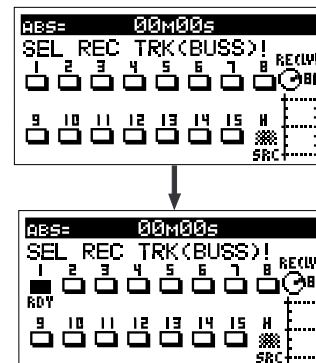

RECORDING System

Unlike conventional systems, the VF-16 records on a hard disk storage device, instead of cassette tape. Sound source recording can start from any point on a formatted disk, as long as the point is within a 24 hour time range in ABS time. Note that it is also possible to move (locate) to any point within that time range, as well. Just think of the VF-16 as coming with a tape that is pre-programmed with a 24 hour counter.

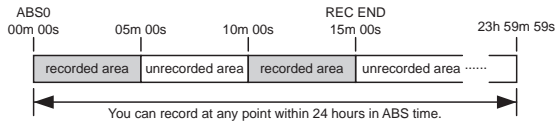

The REC time of cassette tape type recorders vary according to the REC time of the tape. Recording with the VF-16 is more efficient since unrecorded areas of the disk are not used although the REC time is not unlimited.

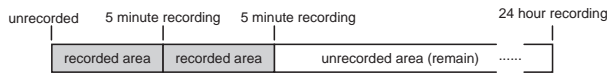

PROGRAM

You can use up to a maximum of 99 “24-hour time counted tapes” with the VF-16. This tape is called a “Program”.

Note that a program exists individually on the hard disk. Therefore, each respective program can be freely recorded, played and edited without affecting other programs. A program can be named with a program title, making it easier to identify and file the musical piece. In the usual menu, the Program appears on the LCD as shown in the following Figure.

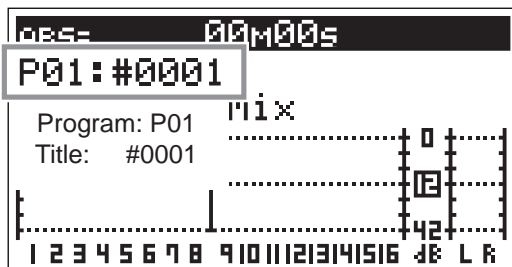

REMAIN Indicator

The REMAIN indicator shows how much recording time is left on hard disk in use.

The VF-16 is controlled with a 24-hour clocked program. Note that the REC time varies according to how much space there is left on the hard disk.

By switching the LCD, the VF-16 remain display appears in the following manner, as shown in the figure below. The rough recordable time on the hard disk is computed in terms of a mono-track basis. The value indicates the available recordable time and disk space when recording one mono track.

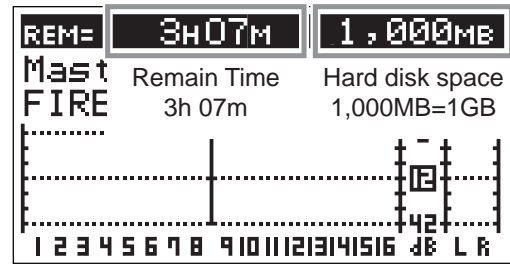

A mono-track refers to one track. Therefore, a mono-track REMAIN time is the recordable length on the hard disk space available when recording only one track.

It is possible to compute the recordable time by dividing the REMAIN time with the number of tracks to record. Therefore, if four tracks are simultaneously recorded, then the recordable time is 46 minutes (3 hours 7 minutes divided by 4). If eight tracks are simultaneously recorded then the recordable time is 23 minutes (divided by 8), and for sixteen tracks the recordable time would be 12 minutes (divided by 16).

The VF-16 manages up to 99 programs on the hard disk. Note that the space on the hard disk is slightly reduced as the number of programs increase, since each program contains various settings, in addition to the REC data.

Therefore, it is important to always check the REMAIN time left prior to starting the recording, to ensure that you have enough hard disk space to work with.

A shortage of hard disk space will stop the recording.

CHANNEL and TRACK

According to this manual, “channel” refers to mixer items and “track” refers to recorder items.

For example, a sentence may read as follows.

“One track of recorder play music will be started on the channel 1 fader of the mixer.” “Eight channels worth of signals from input A to H will be recorded on tracks 7 and 8 of the recorder.”

ADDITIONAL TRACK

One program on the VF-16 consists of 24 tracks.

The user can record, play and edit Tracks 1-16.

There are also 8 additional tracks (17-24). These 24 tracks can be alternately exchanged in one track or an 8 track block. This is called track exchange.

This makes it possible to record solo parts on several tracks, exchange the parts and compare the results. The rhythm section recorded on multiple tracks can also be completely exchanged and remixed with this feature, which is a convenience in numerous ways.

Note that tracks 17-24 cannot be recorded, played or edited. They must be exchanged with tracks 1-16 to execute these features.

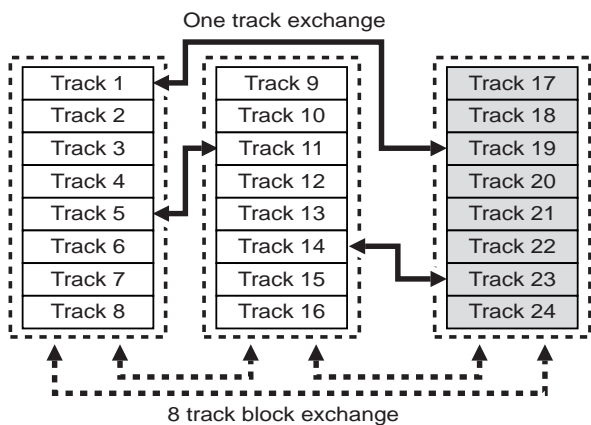

INPUT Monitoring and PLAYBACK Monitoring

There are two ways to monitor the signal output (track sound) from each track with the VF-16 recorder: input monitoring and playback monitoring.

Playback monitoring means that the track output is the sound that is played. This feature is generally used to playback and listen to sounds that have already been recorded. Playback monitoring is generally used to playback sound.

Input monitoring means the signals (sounds to be recorded) input on that track are directly sent to the track output. This feature is used to check the REC level of the sound to record.

Therefore, tracks that are able to be input monitored are either in the “READY” or recording state.

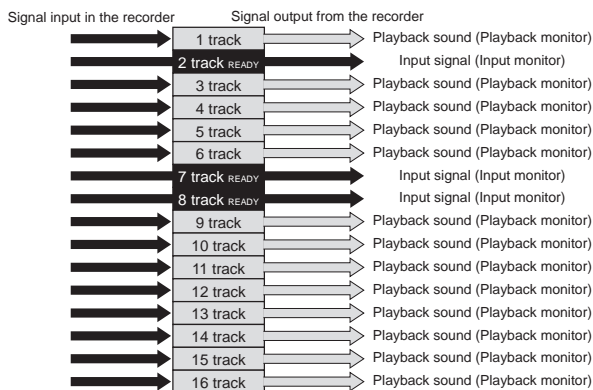

EVENT

When recording with the VF-16, an independent audio file for each recording is respectively created on the tracks recorded. Remember that silence is also recognized as one 0 file. These audio files and 0 (silent) files are called an “events”. A total of 512 events can be created for each track with the VF-16. An excess of 512 events cannot be recorded. It is rare that this happens in normal use. The VF-16 is also complete with the function to indicate the current number of events. An alarm will sound when exceeding the maximum number of events authorized. This problem can be resolved by saving or loading the program (procedures described later) in such case. The following are specific examples of the number of events.

- A. The VF-16 counts the silent portion of a silent track, which is counted as one file, but not recorded with any sound. Therefore, this means that there will be one file on the track.
- B. One audio file is created when recording sound on a track. Therefore, this means that there will be two files on the track.
- C. A new audio file is created when consecutively recording. Therefore, this means that there will be three files on the track.
- D. An audio files is created after a 0 file, when re-recording after fast forward. Therefore, this means that there will be five files on the track.
- E. When straddling (b) and (c) to record, the track will have four files, and thus, the number of events are reduced.

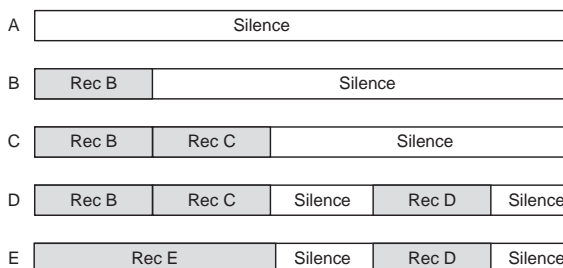

TRIM

It is important to take care when analog signals input are converted into digital signals (A/D conversion) when recording with the VF-16.

TRIM is used to tune this process and the PEAK LED is used to monitor the process.

If the trim gain is too high ([PEAK] LED illuminated) for the analog signals input into [INPUT] A to H, then the signals input will be converted into distorted (clipped) digital signals, which will sound like noise. Once converted with this noise, it is not possible to eliminate this distortion from the sound with the mixer or recorder. Therefore, it is important to tune the [TRIM] to a level where the “[PEAK] LED fluctuates between the illuminating or not” point at the maximum volume of the signal input.

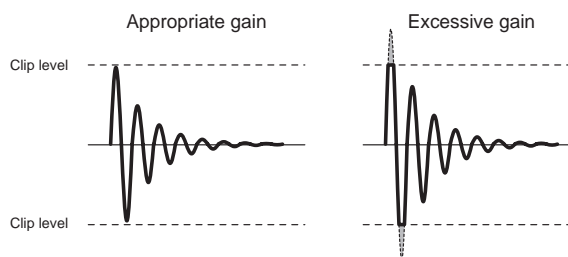

FADER

The VF-16 features 16 channel faders and 1 master fader. Among the faders, the faders for channels 1 to 8 are always started up with output signals from the recorder of tracks 1 to 8 (PLAYBACK or INPUT Monitoring) to adjust this level. The master fader is always used to adjust the output level of the stereo output.

“Signals input from A to H” or “signals output from the recorder” can be selected as signals to fade and the fade level can be adjusted with faders for channels 9 to 16.

This is a way to easily record with the minimum faders along with the earlier mentioned “2 recording modes.”

It is not possible to mix the playback sound of tracks 9 to 16 if inputs A to H are started for all channel faders of 9 to 16. However, this can be prevented, since during normal use, the number of signals input are reduced when recording to tracks 9 to 16 (leaving only the solo part, etc.).

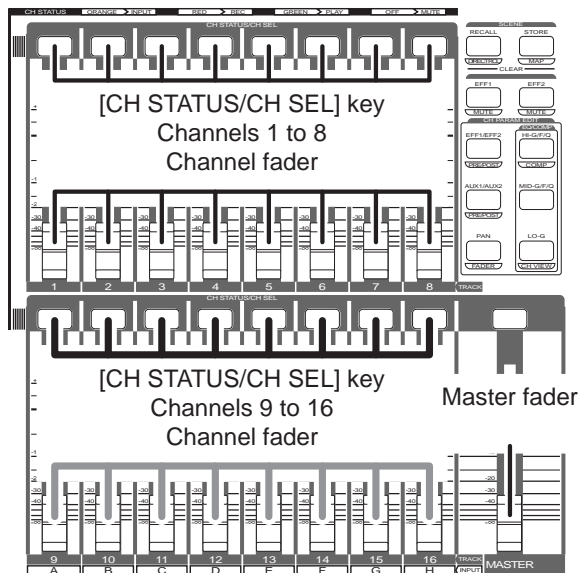

[CH STATUS/CH SEL] Key

The [CH STATUS/CH SEL] Key is the most important key when operating the VF-16.

The status and contents of operation varies according to selections made with this key.

- * Under normal conditions, the key illuminates or flashes to indicate that the signal is input “INPUT” into the current channel fader, the playback sound “TRACK” is started, or the track is ready to record (READY). This key also functions as the fader ON/OFF (Mute) key. In this case the key is not lit.

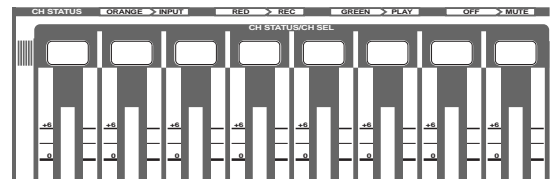

- * To set the send level to the built-in effect or set the equalizer settings of each channel, press the keys to set each parameter shown in the figure below and then press the [CH STATUS/CH SEL] key to select the channel to set.

It is possible, for example, to set the PAN of one channel signal when the channel 1 [CH STATUS/CH SEL] key is pressed after pressing the [PAN] key. All channels can be set by pressing the [CH STATUS/CH SEL] key of channels 1 to 16.

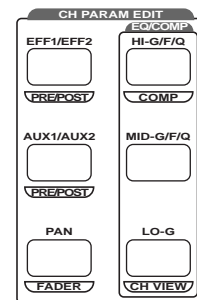

- * When the [CH STATUS/CH SEL] key is pressed, the status will require selection of either “INPUT” or “TRACK” for channel faders 9 to 16, as mentioned earlier. Therefore, operate only the [CH STATUS/CH SEL] key of channels 9 to 16 to switch between “INPUT” or “TRACK,” each time the key is pressed.
- * When pressing the [BUSS-SOURCE] key, the status will require selection of a channel to send to “REC BUSS”, as mentioned earlier. Therefore, the channel in which the [CH STATUS/CH SEL] key is pressed is sent to the “REC BUSS”.

All channels are selected up to this point. The following two types only select tracks.

- * It is possible to select the track to record (REC READY) in each respective REC mode by pressing the [BUSS-REC TRK] key and [DIRECT-REC TRK] key.

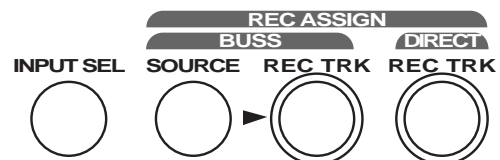

TIME BASE

The term “Time Base” frequently appears in the text of this manual. The time base plays the same role as the “tape counter” of conventional tape recorders, and is used to show the location of the recorder.

There are 3 types of time bases:

1. ABS (Absolute Time) indication
2. BAR/BEAT/CLK (Bar, Beat, Clock) indication
3. MTC (MIDI Time Code)

The user can switch between time bases by pressing the [DISP SEL/TIME BASE] key, while the [SHIFT] key is depressed.

An ABS (Absolute Time) base is the “absolute time” of the hard disk. A time base counter between 00H 00M 00S (ABS 0) and 23H 59M 59S is created when creating a program. According to the following figure, the recorder is located at a 00M (minute) 00S (second) ABS point. The H (hour) appears when the ABS exceeds the one hour mark.

ABS 0 is the universal standard point to manage the recorder location, and correlates with other time bases.



BAR/BEAT/CLK indicate the “Bar, Beat, Clock” that are created with the tempo map (beat and tempo) of the VF-16.

According to the following figure, the recorder is located at -002BAR (Bar 2) 1BEAT (Beat 1) of the BAR/BEAT/CLK.

BAR/BEAT/CLK set the ABS 0 location as Bar -002 as the offset position.

The location of the bar thereafter is determined according to the beat and tempo setting.

The default setting of ABS 0 is set at Bar -002, however, this setting is variable between Bars -009 and -002.



MTC set the ABS 0 location to MTC **H**M**S. In other words, MTC sets the time base to start MTC from a certain time, which serves as the offset time, to synchronize the following 24 hour MTC time base with the ABS to count the time. If, for example, ABS 0 is set to MTC 1H, then MTC starts from 1H and ABS 1H (one hour elapsed) will be MTC 2H.

The MTC time set as ABS 0 is called the “MTC Offset”. According to the figure below, the current location of the recorder is at MTC 00H (hour), 59M (minutes), 57S (seconds).

The default setting of the MTC offset is set to 00H 59M 57S 00F 00SF. This time base can be changed to any 24 hour clock.



It is also possible to change the setting to Bar 001 and Beat 1 of BAR/BEAT/CLK, instead of using the ABS 0 location point.

The following illustrates the relationship between the 3 time bases.

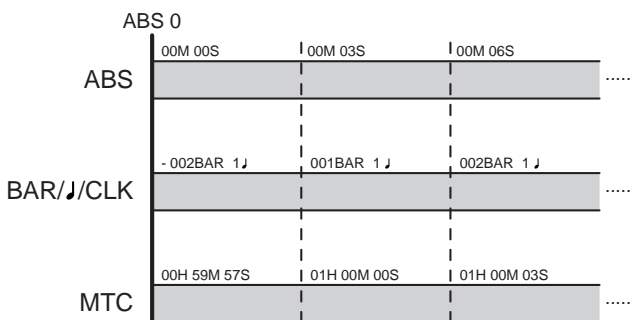

Names and Functions

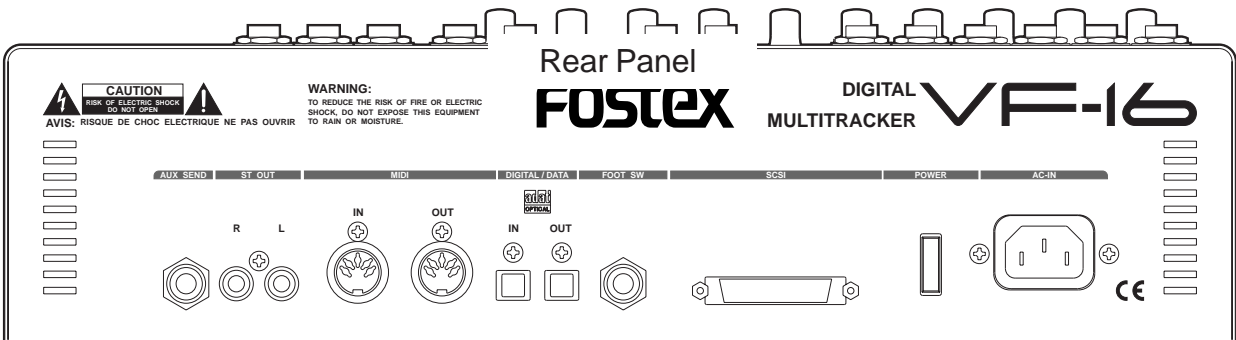
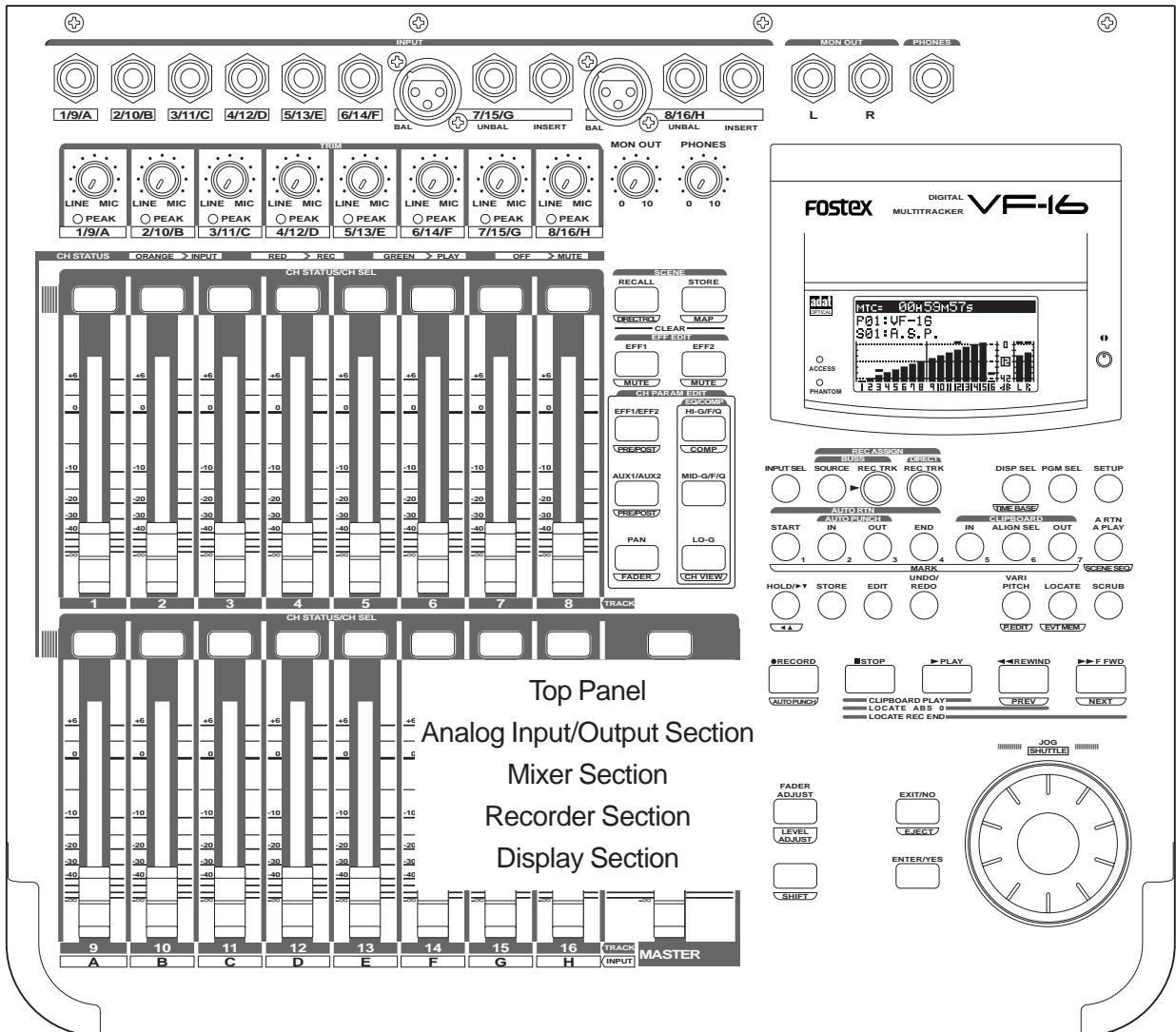

*1. All keys on the panel will be indicated with a [] around the name in this manual.
 Example: [PLAY] key, [INPUT] terminal, etc.

*2. All keys that require the [SHIFT] key to be depressed to take effect will be underlined.
 Example: [EFF EDIT-EFF1/MUTE] key, etc.

*3. Channel is represented as “ch” and track as “trk” according to the contents.
 Example: ch1 fader, trk16, etc.

Top Panel
Analog Input/Output Section

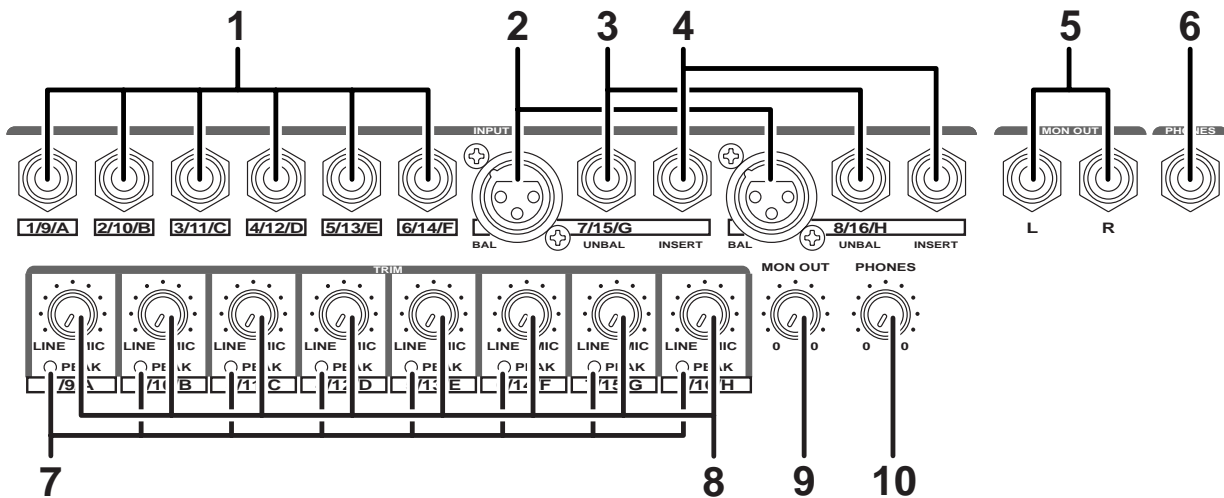

1. [INPUT] (Unbalanced) Jack: A to F
 - * This adjusts the unbalanced output of the external sound source.
 - * Standard Input Level: -50dBV to + 2dBV
 - * Connector: Phones jack
 2. [INPUT BAL] (Balanced) Jack: G, H
 - * Connect to the balanced output of the external sound source.
 - * Standard Input Level: -50dBV to + 2dBV (approx. -48dBu to +4dBu)
 - * Connector: XLR-3-31 type (No. 2 Hot)
 - * Phantom power (+48V) for condenser mics.
 - * This input is disconnected when [INPUT UNBAL] jacks G and H are plugged.
 3. [INPUT UNBAL] (Unbalanced) Jack: G, H
 - * Connections with unbalanced output from external sound source.
 - * Standard Input Level: -50dBV to + 2dBV
 - * Connector: Phones jack
 - * [INPUT UNBAL] jacks G and H are disconnected when this input is plugged.
 4. [INSERT] Jack: G, H
 - * External effector (generally a compressor/limiter, etc.) only used for G and H channel input is connected.
 - * Standard Input/Output Level: -10dBV
 - * Use a Y-cable, as shown below, to connect an external effector since the ø6 TRS phones jack is used.
 5. [MON OUT] (Monitor Output) Jack: L, R
 - * Connect a speaker with internal amp or amp + speaker for monitoring purposes.
 - * Standard Output Level: -10dBV
 - * Connector: Phones jack
 6. [PHONES] (Headphones) Jack
 - * Headphones connection for monitoring purposes.
 - * Connector: TRS Phones jack
 7. [PEAK] LED: 1 to 8
 - * Lights ON if the input signal is approx. 2dB lower than the clipping level.
 - * Tune the [TRIM] knob whether to light ON or OFF the LED for the gain.
 8. [TRIM] Knob: 1 to 8
 - * Adjusts the gain according to the input signal.
 - * Gain is adjustable between -50dBV (MIC) and +2dBV (LINE).
 9. [MON OUT] (Monitor Output) Knob
 - * Adjusts the output level from the [MON OUT] jack.
 10. [PHONES] (Headphones) Knob
 - * Adjusts the output level from the [PHONES] jack.
- For more details, refer to the respective instructions of each item.

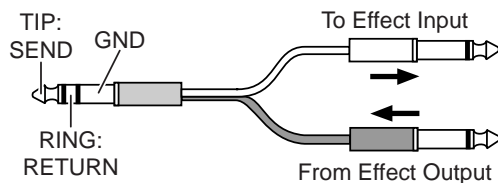

Mixer Section

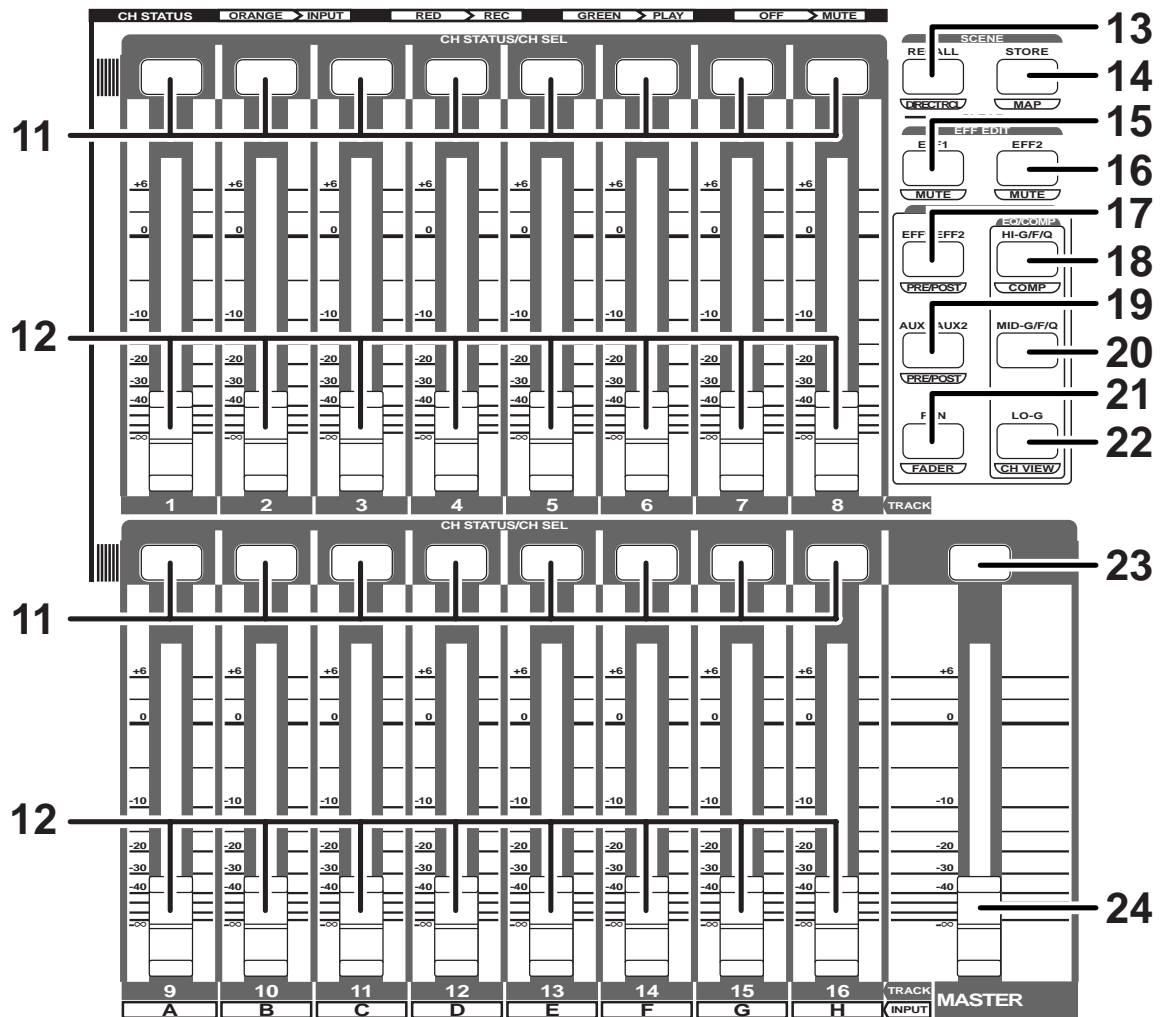

11. [CH STATUS/CH SEL] Key: channels 1-16

- * ON/OFF key for each channel during normal display (explained later).
- * Select the channel to CHECK/CHANGE the setting with ([CH PARAM EDIT] Key (No. 17-22) when CHECKING/CHANGING various PAN, equalizer and other mixer parameters.
- * Select the recorder track (1-16) for REC READY or REC CANCEL (SAFE) status (flashing [REC ASSIGN-DIRECT] key or [REC ASSIGN-BUSS] key)) when selecting the track to record.
- * The flashing key illustrates the following STATUS:

[ORANGE]: The level of the input signals [INPUT] into input A to H are adjustable. Only channels 9-16 are adjustable with the fader.

[GREEN]: The level of the audio [TRACK (PLAY)] on the track are adjustable with the fader.

[OFF]: The signals to the fader are [MUTE] (no sound).

[RED]: The corresponding tracks (1-16) are READY (to record). The [GREEN] and [RED] key will alternately flash. The light will remain ON during the recording process.

12. Channel Fader: channels 1-16

- * The 1-8 channel faders are used to adjust the audio level [TRACK] of tracks 1-8.
- * The 9-16 channel faders are used to adjust the sound level of signals input into A to H or audio levels [TRACK] of 9-16. Use the [INPUT SEL] key to choose which level to adjust.

13. [SCENE-RECALL/DIRECT RCL] Key

- * This is used to recall the scene memory.
- * Press this key while the [SHIFT] key is depressed for direct scene memory recall.
- * Simultaneously press this key and the [SCENE-STORE/MAP] key to erase the scene memory.

14. [SCENE-STORE/MAP] Key

- * This is used to store scene memory.
- * Press this key while the [SHIFT] key is depressed to CHECK/CHANGE the scene map.
- * Simultaneously press this key and the [SCENE-RECALL/DIRECT RCL] key to erase the scene memory.

15. [EFF EDIT-EFF1/MUTE] Key

- * This is used to CHECK/CHANGE the EFFECT type and parameter settings of EFFECT 1.
- * Press this key while the [SHIFT] key is depressed to turn ON/OFF the mute feature of EFFECT 1.

16. [EFF EDIT-EFF2/MUTE] Key

- * This is used to CHECK/CHANGE the effect type and parameter settings of EFFECT 2.
- * Press this key while the [SHIFT] key is depressed to turn ON/OFF the mute feature of EFFECT 2.

17. [CH PARAM EDIT-EFF1/EFF2/PRE/POST] Key

- * This is used to CHECK/CHANGE the send level settings of EFFECT 1 or EFFECT 2. The EFFECT 1 and EFFECT 2 settings alternate every time the key is pressed.
- * Press this key while the [SHIFT] key is depressed to CHECK/CHANGE the PRE/POST settings of EFFECT 1 or EFFECT 2.
- * Use the [CH STATUS/CH SEL] Key to select the channel to change any settings together.

18. [CH PARAM EDIT-EQ/COMP-HI/G/F/Q/COMP] Key

- * This is used to CHECK/CHANGE the high frequency parametric equalizer settings. The parameter settings alternate every time the key is pressed.
- * Press this key while the [SHIFT] key is depressed to CHECK/CHANGE the COMPRESSOR settings.
- * Use the [CH STATUS/CH SEL] Key to select the channel to CHECK/CHANGE any settings together.

19. [CH PARAM EDIT-AUX1/AUX2/PRE/POST] Key

- * This is used to CHECK/CHANGE the send level settings of AUX 1 or AUX 2. The AUX 1 and AUX 2 settings alternate every time the key is pressed.
- * Press this key while the [SHIFT] key is depressed to CHECK/CHANGE the PRE/POST settings of AUX 1 or AUX 2.
- * Use the [CH STATUS/CH SEL] Key to select the channel to change any settings together.

20. [CH PARAM EDIT-EQ/COMP-MID-G/F/Q] Key

- * This is used to CHECK/CHANGE the midrange frequencies of the parametric equalizer settings.
- * Press this key while the [SHIFT] key is depressed to CHECK/CHANGE the settings.

21. [CH PARAM EDIT-PAN/FADER] Key

- * This is used to CHECK/CHANGE the PAN settings.
- * Press this key while the [SHIFT] key is depressed to show the current fader location. Finer level adjustment is possible by using the [JOG] dial.
- * Use the [CH STATUS/CH SEL] key to select the channel to change any settings together.

22. [CH PARAM EDIT-EQ/COMP-LO-G/CH VIEW] Key

- * This is used to CHECK/CHANGE the low frequencies of the parametric equalizer settings.
- * Press this key while the [SHIFT] key is depressed to show the settings of the selected channel.

- * Use the [CH STATUS/CH SEL] key to select the channel to change any settings together.

23. [MASTER CH STATUS/CH SEL] Key

- * This becomes the master channel ON/OFF key when the LCD is in the normal display mode (described later).
- * Select the channel to CHECK/CHANGE any settings with the ([CH PARAM EDIT] Key (No. 17-22)) to CHECK/CHANGE any PAN, equalizer or other mixer settings.
- * The STATUS of the key lights ON are defined below.

[GREEN]: The level of the stereo buss L, R outputs are adjustable with the fader.

[OFF]: The signals to the master fader are [MUTE] (no sound).

24. [MASTER] Fader

- * This is used to adjust the master level of the sound signals output from the STEREO OUT L, R jacks.

For more details, refer to the respective instructions of each item.

Recorder Section

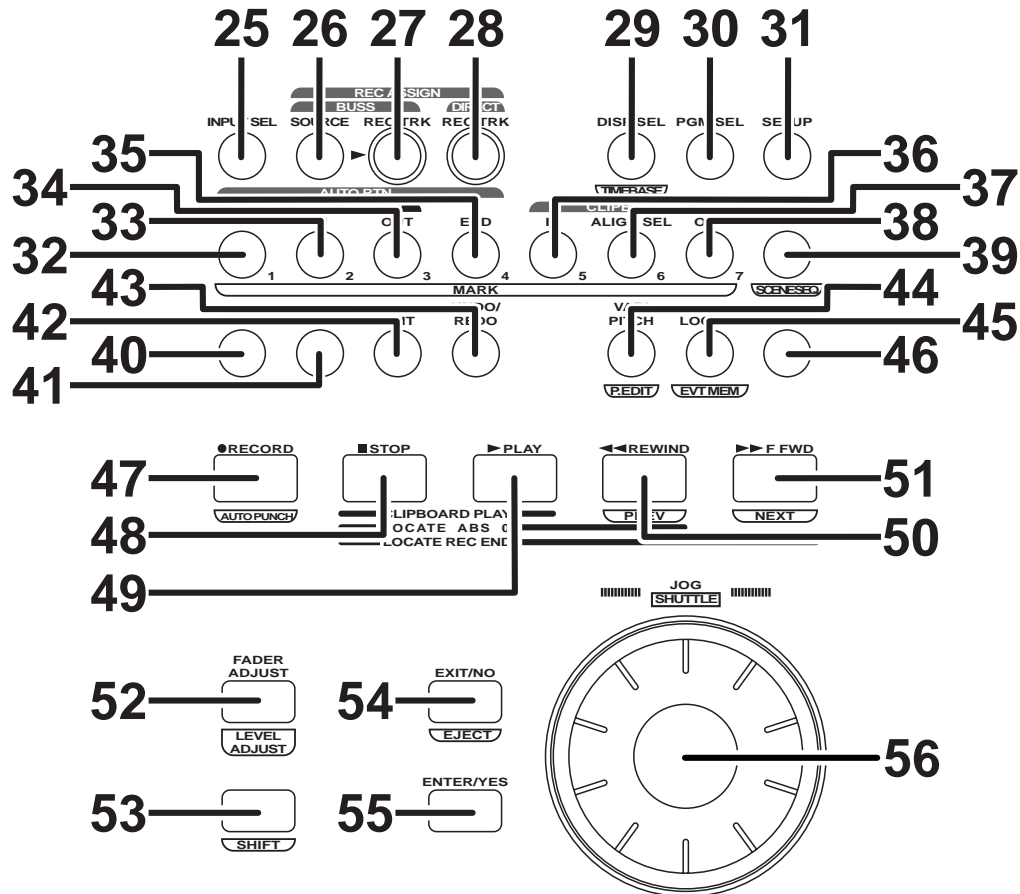
**25. [INPUT SEL] Key**

- * Set whether to send the A to H input signals [INPUT] or track 9-16 play [TRACK] sounds to the faders of channel faders 9 to 16.

26. [REC ASSIGN-BUSS-SOURCE] Key

- * Select the channel (SOURCE) to send to the REC BUSS during "BUSS" recording. Select the SOURCE channel with the [CH STATUS/CH SEL] key.
- * This key lights ON when the SOURCE is selected.

27. [REC ASSIGN-BUSS-REC TRK] Key

- * The track (READY) to record in "BUSS" recording is selectable when this key is flashing. Set READY track with the [CH STATUS/CH SEL] key.
- * This key lights ON when the READY track is set for "BUSS" recording.

28. [REC ASSIGN-DIRECT-REC TRK] Key

- * The track (READY) record in "DIRECT" recording is selectable when this key is flashing. Set READY track with the [CH STATUS/CH SEL] key.
- * This key lights ON when the READY track is set for "DIRECT" recording.

29. [DISP SEL/TIMEBASE] Key

- * This key is used to alternate the menu shown on the LCD in the following order.
- * The tracks recorded vary, as shown below, according to the connection jack.

- Current location of TIME BASE selected
Shows the current location of the sound.
- REMAINING TIME BASE Selected (time remaining)
Shows the time remaining and space available on the disk for recordings (in terms of mono track).
- MTC Time Input
Shows the MTC time input in the [MIDI IN] jack.
This is a convenience for operations as a slave device.

- * The user can switch between time bases, as shown below, by pressing the [DISP SEL/TIME BASE] key, while the [SHIFT] key is depressed.

- ABS (Absolute Time) Indication
An absolute time base from 00H 00M 00S (ABS 0) to 24H 00M 00S.
- BAR/BEAT/CLK (Bar)
The "Bar, Beat, Clock" of the beat and tempo set with the internal tempo map.
- MTC (MIDI Time Code)
Display of the MTC time setting.

30. [PGM SEL] Key

- * This is used to switch between programs 01 to 99.
This is also used to create new programs.

31. [SETUP] Key

- * This is used to go into the setup mode to set various parameters of the recorder and mixer.

32. [AUTO RTN-START/MARK1] Key

- * This key is used to CHECK/CHANGE the parameters saved at the start point (AUTO RETURN START POINT) when executing auto return or auto repeat.
- * Press this key while the [SHIFT] key is depressed to CHECK/CHANGE the parameters saved in [MARK1].
- * This can be used as Locate Memory.

33. [AUTO PUNCH-IN/MARK2] Key

- * This key is used to CHECK/CHANGE the parameters saved at the recording start point (PUNCH IN POINT) when executing auto punch in/out, paste or erase.
- * Press this key while the [SHIFT] key is depressed to CHECK/CHANGE the parameters saved in [MARK2].
- * This can be used as Locate Memory.

34. [AUTO PUNCH-OUT/MARK3] Key

- * This key is used to CHECK/CHANGE the parameters saved at the recording end point (PUNCH OUT POINT) when executing auto punch in/out or erase.
- * Press this key while the [SHIFT] key is depressed to CHECK/CHANGE the parameters saved in [MARK3].
- * This can be used as Locate Memory.

35. [AUTO RTN-END/MARK4] Key

- * This key is used to CHECK/CHANGE the parameters saved at the end point (AUTO RETURN END POINT) when executing auto return or auto repeat.
- * Press this key while the [SHIFT] key is depressed to CHECK/CHANGE the parameters saved in [MARK4].
- * This can be used as Locate Memory.

36. [CLIPBOARD-IN/MARK5] Key

- * This key is used to CHECK/CHANGE the parameter saved at the start point (CLIPBOARD IN POINT) when copying from or pasting to the clipboard.
- * Press this key while the [SHIFT] key is depressed to CHECK/CHANGE the parameters saved in [MARK5].
- * This can be used as Locate Memory.

37. [CLIPBOARD-ALIGN SEL/MARK6] Key

- * This key is used to CHECK/CHANGE the parameter saved at the align point (ALIGN POINT) when copying/pasting or moving/pasting.
- * Press this key while the [SHIFT] key is depressed to CHECK/CHANGE the parameters saved in [MARK6].
- * This can be used as Locate Memory.

38. [CLIPBOARD-OUT/MARK7] Key

- * This key is used to CHECK/CHANGE the parameter saved at the end point (CLIPBOARD OUT POINT) when copying from or pasting to the clipboard.
- * Press this key while the [SHIFT] key is depressed to CHECK/CHANGE the parameters saved in [MARK7].
- * This can be used as Locate Memory.

39. [A RTN/A PLAY/SCENE SEQ.] Key

- * Every time this key is pressed the mode switches from Auto Play -> Auto Return -> Auto Repeat -> OFF, and this mode is shown on the LCD.

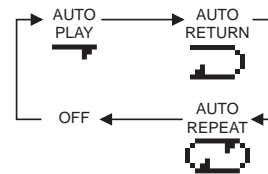

- * Press this key while the [SHIFT] key is depressed to turn ON/OFF the scene sequence. When scene sequence is switched “on”, the normal display section “S**” will change to reversed black and white display.

40. [HOLD/>] Key

- * This key is used to hold the parameter (time or BAR/BEAT/CLK) when the key is pressed. The parameter is simultaneously displayed and is editable.
- * When this key is pressed at editing of the value, the digit can be moved to the right or below, and if this key is pressed while pressing on the [SHIFT] key, it can be moved to the left or above.

41. [STORE] Key

- * This key is used to store the edited parameters (time or BAR/BEAT/CLK) to the editing point (AUTO PUNCH POINT, etc.), MARK point, LOCATE MEMORY, etc.

42. [EDIT] Key

- * This key is used to copy, past and edit the sound. The following 5 types of sound editing types are possible.
 - [Copy Clip]
 - [Move Clip]
 - [Copy Paste] or [Move Paste]
 - [Erase]
 - [Track Exchange]

43. [UNDO/REDO] Key

- * This key is used to copy, past and edit sound as well as cancel and undo the auto punch in/out, recording and other processes.
- * Press this key again to return to the state prior to undo (redo).

44. [VARI PITCH/P.EDIT] Key

- * Every time this key is pressed the mode alternates between VARI PITCH (PLAY/REC at different speed) ON (Key: Light ON)/OFF (Key: Light OFF).
- * Press this key while the [SHIFT] key is depressed to alter the speed variation (Pitch Edit).

45. [LOCATE/EVT MEM] Key

- * This key is used to locate the editing point (AUTO PUNCH POINT, etc.) and Mark Point.
- * The last located parameter is saved as the parameter of this key, every time. Therefore, it is possible to simply press this key to go to the last located point (LAST LOCATE).
- * Press this key while the [SHIFT] key is depressed to edit the parameter saved in Event Memory (Event number 01-99).

46. [SCRUB] Key

- * This is used to digitally scrub sounds in the FWD and REV direction without any change in pitch.

47. [RECORD/AUTO PUNCH] Key

- * Press the [PLAY] key while this key is depressed (or press this key while the [PLAY] key is depressed) to start recording the READY track. (Key: Light ON)
- * The READY track goes in the input monitor mode when only this key is pressed (Key: Flashing). Pressing this key again cancels the input monitor and the READY track goes to the Playback Monitor mode.
- * Press this key while the [SHIFT] key is depressed to turn ON/OFF AUTO PUNCH.

48. [STOP] Key

- * Press this key during PLAY, REC, F FWD, REW to stop recorder operations.
- * Press this key in the SETUP mode to escape one stage each from the SETUP mode.
- * Press the [PLAY]/[REWIND]/[F FWD] key while this key is depressed for the following operations.
- * This is used to CANCEL/PAUSE the SETUP menu settings, copy/paste and various other sound editing processes.

[STOP]+[PLAY]: CLIPBOARD PLAY

Play the sound that is copied or moved to the clipboard.

[STOP]+[REWIND]: LOCATE ABS0

Locate the beginning of the ABS (ABS = 00M 00S 00F) of the current program.

[STOP]+[F FWD]: LOCATE REC END

Locate the portion in which sound is recorded (REC END) on the current program.

49. [PLAY] Key

- * Press this key to start playing the recorder.
- * Press the [RECORD] key while this key is depressed (or press this key while the [RECORD] key is depressed) to start recording the READY track.
- * PUNCH OUT (REC CANCEL) takes place when only the [PLAY] key is pressed during the recording process.
- * Press this key while the [STOP] key is depressed to start "CLIPBOARD PLAY".

50. [REWIND/PREV] Key

- * Press this key while the machine is stopped for 30X rewind speed.
- * 3X cuing (rewinding with sound) takes place when this key is pressed during the PLAY status.
- * Press this key while the [SHIFT] key is depressed to locate the "PREV" (previous) memory (locate the previous event memory).
- * Press this key while depressing the [STOP] key to "LOCATE ABS 0".
- * Press this key while editing the parameters to move the column (digit) to edit.

51. [F FWD/NEXT] Key

- * Press this key while the machine is stopped for 30X rewind speed.

- * 3X cuing (rewinding with sound) takes place when this key is pressed during the PLAY status.
- * Press this key while the [SHIFT] key is depressed to locate the "NEXT" memory (locate the next event memory).
- * Press this key while depressing the [STOP] key to "LOCATE REC END".
- * Press this key while editing the parameters to move the column (digit) to edit.

52. [FADER ADJUST/LEVEL ADJUST] Key

- * This key flashes during scene memory recall, etc. to notify the user that the currently set fader parameter and the internally set fader position are not the same.
- * Press this key to go to the Fader Adjust Mode. The internally set fader position is checked. By adjusting the fader setting manually it is possible to adjust the actual fader position according to the internally set fader position.
- * Press this key while the [SHIFT] key is depressed to go to the Level Adjust Mode. This forcibly adjusts the volume to the current fader position.

53. [SHIFT] Key

- * This key is used as the function key for various keys and dials that have a shift function. The key functions are shown at the bottom of the key if the key has a shift function.

54. [EXIT/NO/EJECT] Key

- * This is used to CANCEL/PAUSE the SETUP menu settings, copy/paste and various other sound editing processes. This key is the opposite of the [ENTER/YES] key.
- * Press this key while the [SHIFT] key is depressed to remove the removable type SCSI disk used for backup purposes.

55. [ENTER/YES] Key

- * This is used to SET/EXECUTE the SETUP menu settings, copy/paste and various other sound editing processes. This key is the opposite of the [EXIT/NO] key.

56. [JOG/SHUTTLE] Dial

- * Turn ON the [SCRUB] key, press [CH STATUS/CH SEL] key of a voluntary channel, then turn the jog dial for digital sound scrubbing in the FWD and REV direction without any change in pitch.
- * Turn this dial while the [SHIFT] key is depressed to F FWD/REW between a shuttle speed of 1X to 64X depending on the degree the dial is turned.
- * The jog dial can be used to increase/decrease the parameter settings during the editing process.

For more details, refer to the respective instructions of each item.

Display Section

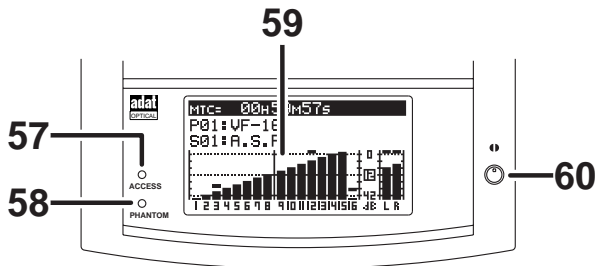

57. [ACCESS] LED

This LED lights ON when the internal hard disk drive or external SCSI device for backup purposes is writing or reading data.

58. [PHANTOM] LED

This lights ON when the phantom power is ON. The phantom power is turned ON/OFF with the setup mode.

59. LCD (Liquid Crystal Display)

The recorder and mixer status and parameters are shown on the LCD.

60. Contrast Adjusting Knob

This is used to adjust the contrast (difference in brightness) of the LCD. Increase or decrease the contrast by turning it clockwise or counterclockwise, respectively.

Rear Panel

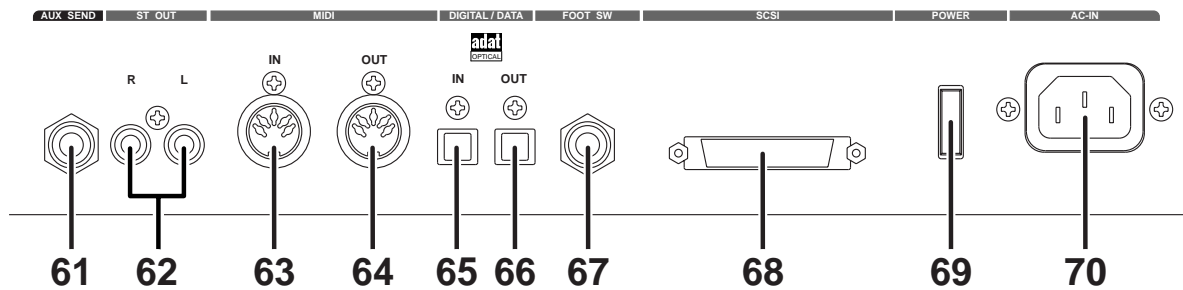

61. [AUX SEND-1/2] Jack

- * External effector or other devices are connected to output the AUX SEND 1/2 signals.
- * Standard Output Level: -10dBV
- * Use a Y-cable, as shown below, to connect an external effector since the ø6 TRS Phones jack is used.

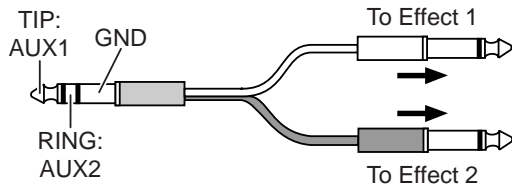

62. [ST OUT-L/R] Jack

- * Master recorders and other devices are connected to output stereo L/R signals.
- * Standard Output Level: -10dBV
- * Connector: RCA (pin)

63. [MIDI IN] Jack

- * Connect to the MIDI OUT jack of an external MIDI device.
- * MIDI control signals such as MMC (MIDI Machine Control) is mainly input.
- * Connector: DIN 5 PIN

64. [MIDI OUT] Jack

- * Connect to the MIDI IN jack of an external MIDI device.
- * MIDI synchronization signals such as MTC (MIDI Time Code) and MIDI clock signals & song position pointers are mainly output.
- * Connector: DIN 5 PIN

65. [DIGITAL/DATA IN] Jack

- * Connect to OPTICAL DIGITAL OUT (S/P DIF) or adat DIGITAL OUT of an external digital device for signal input to the VF-16.
- * This is used to load DAT/adat song data.
- * Connector: Square optical

66. [DIGITAL/DATA OUT] Jack

- * Connect to OPTICAL DIGITAL IN (S/P DIF) or adat DIGITAL IN of an external digital device for signal output from the VF-16.
- * This is used to save DAT/adat song data.
- * Connector: Square optical

67. [FOOT SW] Jack

- * Punch IN/OUT option by connecting the Fostex Model 8051 foot switch (unlatched type).

68. [SCSI] Connector

- * This is where external SCSI devices (SCSI ID to 6) for backup purposes are connected.
- * Connector: Half pitch D-sub, 50-pin, female

69. [POWER] switch

- * This turns ON/OFF the power of the VF-16.

70. [AC IN] Jack

- * This is where the accessory power cable is inserted.

For more details, refer to the respective instructions of each item.

About the hard disk storage device

The VF-16 is complete with a 3.5-inch E-IDE hard disk (storage device) which is formatted in the Master 16 mode. Therefore, there is no need to newly assemble a hard disk or to format the hard disk. The user can immediately start recording with the VF-16. Note that the current hard disk can also be replaced with another model for use with the VF-16. (However, please only use hard disks that Fostex recommends.)

Reformatting the hard disk

This section describes how to reformat the hard disk. The VF-16 adopts a “FDMS-3 (Fostex Disk Management System-3)” format which is a Fostex exclusive format. Eight additional tracks can be used in addition to recording and playing 16-tracks of uncompressed 44.1kHz/16 bit high quality sound.

<Precaution>

Note that, when you reformat your hard disk, you will erase all data saved or recorded on the hard disk, as well as all the settings made. Reformatting your hard disk restore the VF-16 back to the default setting. Always make a point to check that there is no data that you need remaining on the hard disk prior to reformatting.

1. Turn ON the VF-16.

2. Press the [SETUP] key.

The system will go to the SETUP mode. The select display of the SETUP menu appears. (The highlight indicates the menu that is currently selected.)

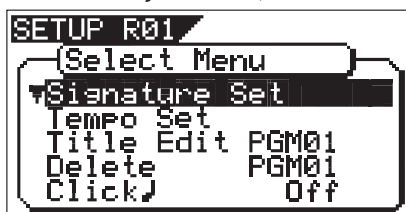

3. Turn the [JOG] dial to highlight the “Disk Format” menu title.

“IDE” indicates the current drive. “SCSI” indicates the backup SCSI drive.

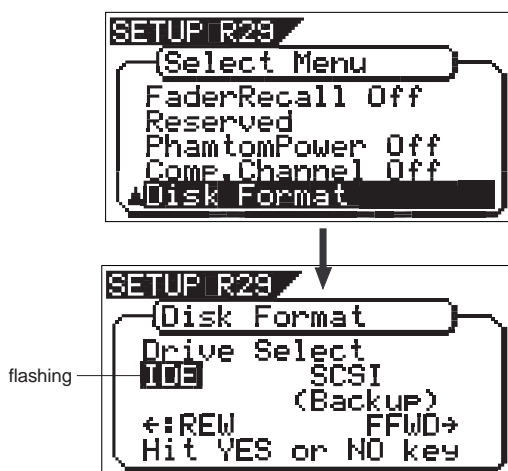

4. Press the [ENTER/YES] key while “IDE” is highlighted.

The menu to select the format type appears. The display will appear as follows, according to the previous format type. “*****” represents the name of the drive.

The hard disk formatted in the “Standard” type upon newly formatting the hard disk will show “Standard” and “Erase”. The hard disk formatted in the “Quick” type upon newly formatting the hard disk will show “Standard” and “Quick”. The user can select one.

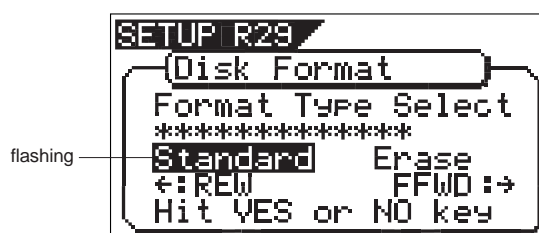

or

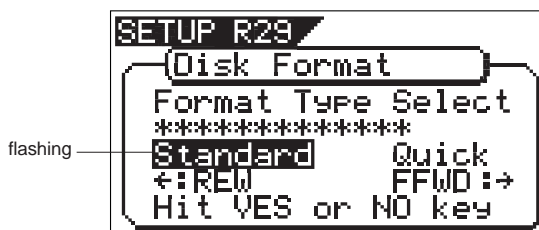

“Standard”	The hard disk is formatted with the access time of the unit sectors, while judging whether the sectors are good or bad. The formatting time tends to be longer with this type, however, the reliability is better. Therefore, it is recommended that this default format type is selected under normal conditions.
“Erase”	This choice is only available when a hard disk previously formatted in the “Standard” type is being reformatted. With this format, the “Standard” type is maintained, while all data on the hard disk are erased. The formatting time is shorter than the time required to format a “Standard” type.
“Quick”	This is a quick formatting procedure in which all hard disk sectors are considered to be good sectors. The formatting time is fast, however, the procedure cannot discover bad sectors. Therefore, it is recommended that this format type is only used when formatting a new hard disk that Fostex has already confirmed to operate normally.

- Select the format type with the [F FWD] key or [REWIND] key. Then press the [ENTER/YES] key. The format type selected is set and “Sure?” flashes.



- Press the [ENTER/YES] key while the [RECORD] key is depressed. If the “Standard” format is selected and executed, the formatting process takes place while showing the progress of the good sectors (Good ***MB) on the disk, bad sectors on the disk (Bad ***MB) and remainder (Remain ***MB). Nothing can be done during the formatting process. Please wait for a while until the process is completed.

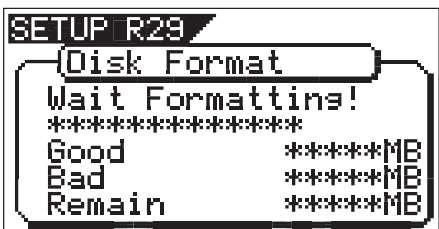

When the hard disk is successfully formatted (formatting completed), the number of sectors and noncontiguous sectors are shown after formatted, then “Completed!” lights up. Formatting is completed instantaneously if either “Erase” or “Quick” is selected and executed. For this reason, the “Completed!” message lights up without showing the progress status while formatting is taking place.

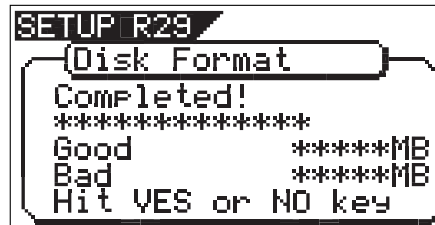

- Press the [EXIT/NO] key (or [STOP] key) to escape from the SETUP mode. The Normal Display appears indicating the beginning of the program (P01) that is automatically created after formatting the hard disk.

Replacing a hard disk

<Operation Confirmed HD & Backup Media List for the VF-16>

The updated information on the operation-confirmed HD and backup media for VF-16 is mentioned in the following Fostex international web site.

<<http://www.fostex.co.jp/int/index.htm>>

For those who are unable to check our web site, please contact the Fostex distributor in your territory.

<Warning>

This section describes the procedures to replace the hard disk. However, we recommended that the customer ask the Fostex Customer Service Department to replace the VF-16 hard disk. Note that the product is not warranted for any malfunctions that may occur after the customer replaces the hard disk on their own. Also note that Fostex will not be held liable for any accidents that may occur during the replacement process or any hard disk damages, if the customer decides to replace their own hard disk on their own.

<Precautions Upon Replacement>

- * Always turn OFF the power of the VF-16 and unplug the power plug from the electric outlet when replacing the hard disk.
- * Always place the hard disk on a flat and stable platform during the replacement process. Place a soft cloth under the unit to protect the product from scratching. Gloves are recommended to prevent any hand injuries.

<Precautions Upon Handling the Hard Disk>

- * A hard disk is an extremely sensitive precision device. Never expose the hard disk to “strong shocks” when replacing, assembling or handling. Never leave the hard disk by a device that generates strong magnetic fields.
- * Always set the DIP switch and Jumper of the newly assembled hard disk to the [MASTER] setting. The hard disk will not operate normally if the setting is set to [SLAVE] when the hard disk is assembled. Refer to the User’s Manual of the hard disk for more details on the DIP switch and Jumper settings.
- * Note that the connector of some hard disks may be stiff, and thus make it difficult or impossible to insert or connect. Never apply excessive force to insert the connector in such case. Always make a point to gently insert the connector. Failure to do so may result in unexpected injuries or damage the hard disk.

1. Unscrew the four screws from the bottom of the main unit that are fixing the panel.

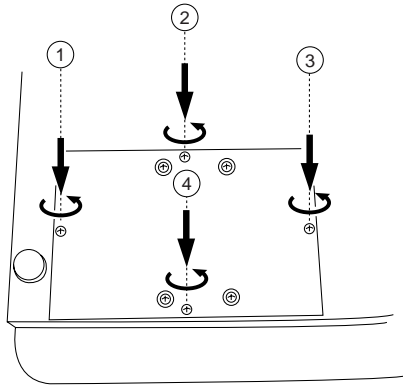

2. Turn over the panel that the hard disk is fixed according to the instructions shown in the figure below.

Note that hard disk cables will be connected. Be careful not to apply excessive force when turning over the panel.

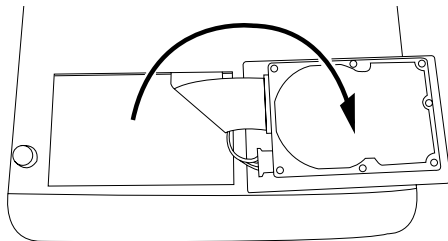

3. Remove the two cable connectors that are connected to the hard disk. Gently hold the connector and slowly pull out.

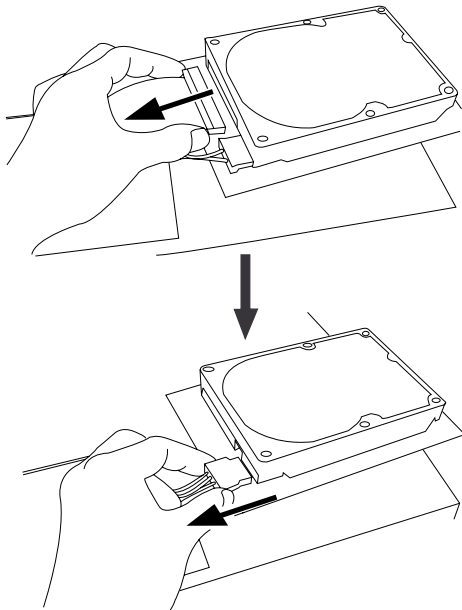

4. After disconnecting the cables, remove the panel that is fixing the hard disk.

Unscrew the four screws with a screwdriver, as shown in the Figure.

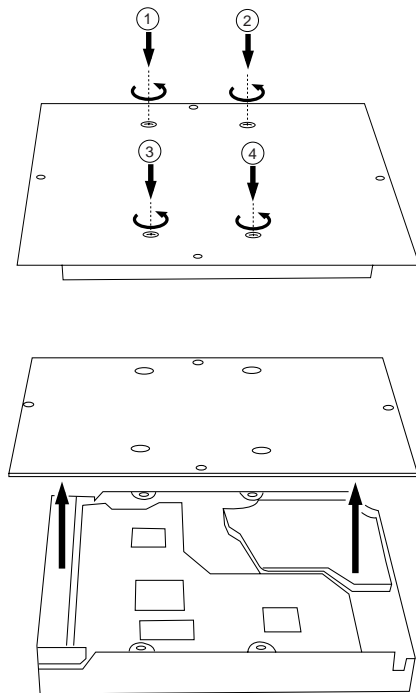

5. Fix a new hard disk to the panel in the reverse order of removing the hard disk as performed earlier. Connect the cables. Then house the hard disk at the bottom of the main unit. Follow the <Precautions> described earlier, and properly assemble the parts.

When the new hard disk is successfully assembled, go to the next section. Now, format the unformatted hard disk.

Chapter 2 Basic Recording and Playback

Connections of Peripheral Equipment

The VF-16 is equipped with input/output jacks to connect the following sound sources and external equipment. Always turn the [MASTER] fader, [MON OUT] knob and [PHONES] knob to "0" when connecting the external equipment to the input/output jacks.

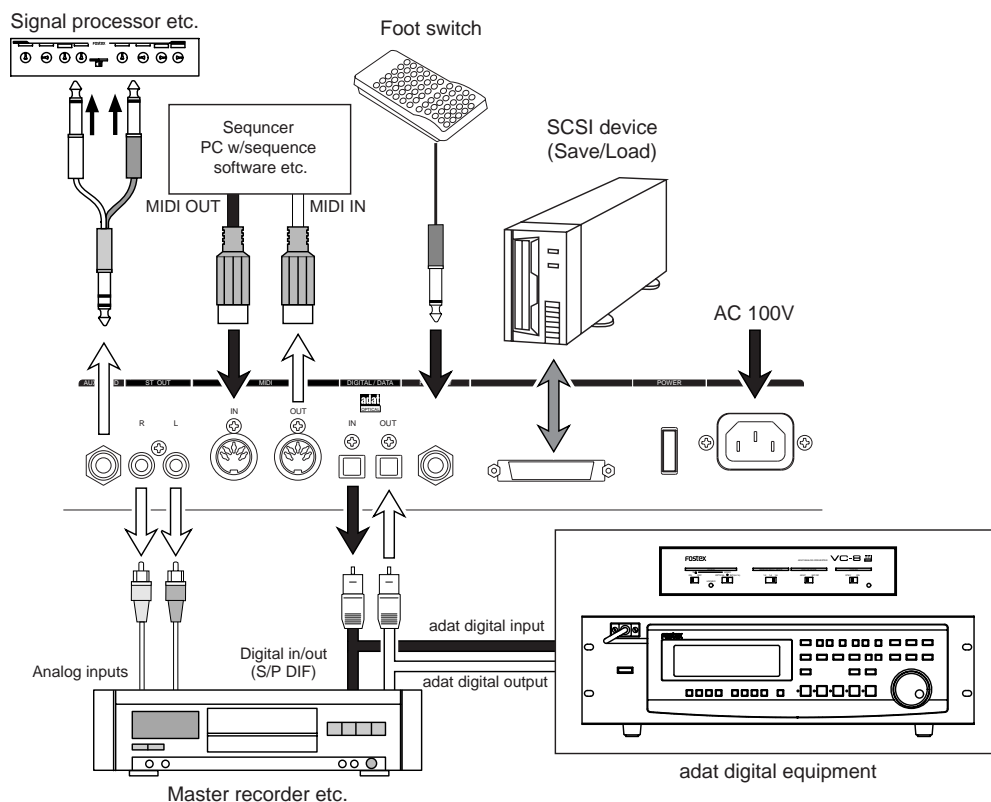
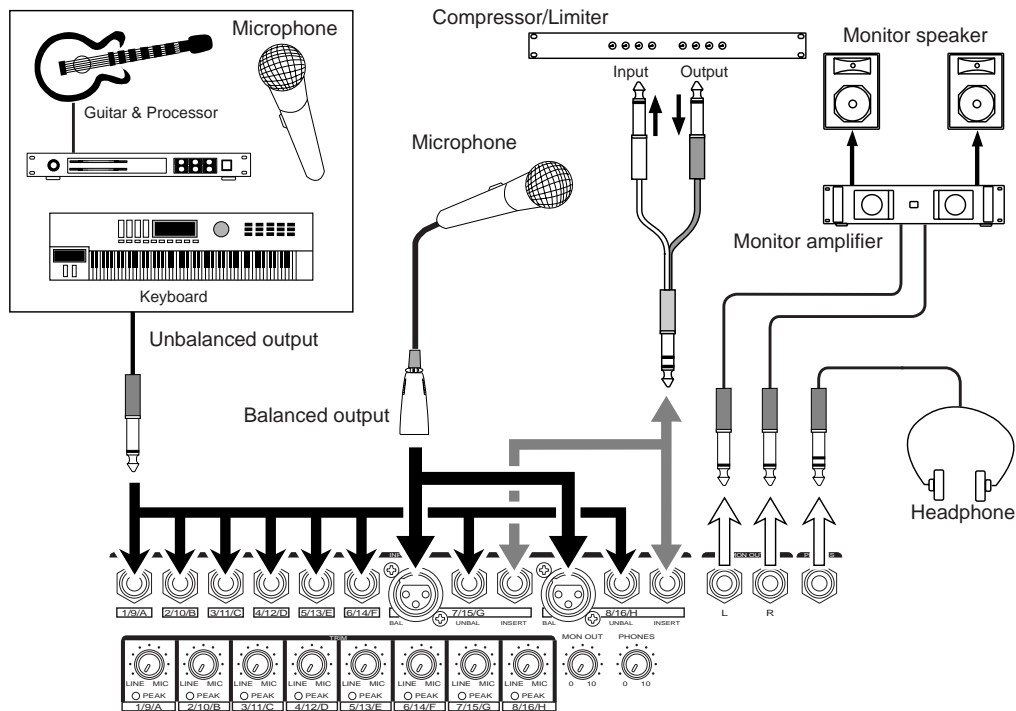

LCD

The following describes the contents shown on the LCD and their operations.

Menu shown when turning power ON

When the VF-16 is turned ON with a hard disk already formatted, the following menu will appear in order: [Initial... (Initializing)] & [Version] -> [Current Dr] -> [IDE] -> [Name of Hard disk (Instantly)] -> [Recording mode (Standard or Quick)].

The head of the program (ABS 0) will then start up at the time base when the power was turned OFF. The LCD menu appearing immediately after turning the power ON is called the "Normal Display".

The "Normal Display" shows the following items for the 3 time bases:

- * Current Location/Program Number & Program Title
- * Scene Number & Scene Name
- * Level Meter of Tracks 1-16
- * Stereo OUT L/R Master Level/Meter

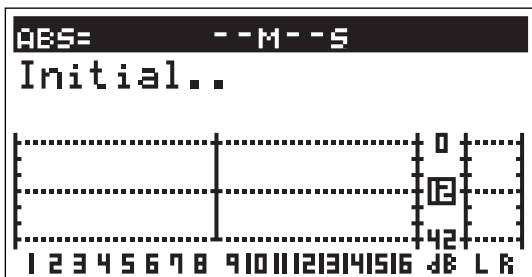

Normal display



Switching the Time Base

The user can switch between time bases, by pressing the [DISP SEL] key, while the [SHIFT] key is depressed. In this case the time base alternates in the order of "1. ABS" -> "2. BAR/BEAT/CLK" -> "3. MTC" ->... The normal display always appears when the time base is switched. Make use of these displays accordingly.

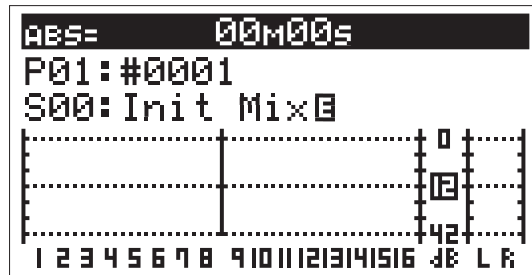

Time Base: Normal Display in ABS.



Time Base: Normal Display in BAR/BEAT/CLK.



Time Base: Normal Display in MTC.

Switching with [DISP SEL] Key

Every time the [DISP SEL] key is pressed the LCD alternately shows the “1.

Normal Display of Current Time Base” -> “2. REMAIN Display of Current Time Base” -> “3. MTC Time Display Input”. The description of each display is defined below.

1. Normal Display of Current Time Base

- * Current time according to current time base.
- * Program number and program title.
The first 9 characters of the program title are shown.
- * Scene number and scene name.
The first 9 characters of the scene name are shown.
- * Level meter of tracks 1 to 16.
- * L/R master level meter



2. REMAIN Display of Current Time Base

- * REMAIN time and space available in mono-track converted units according to the current time base (the following is the case in ABS).*1
- * Format type.
- * Name of hard disk.
- * Level meter of tracks 1 to 16.
- * L/R master level meter.

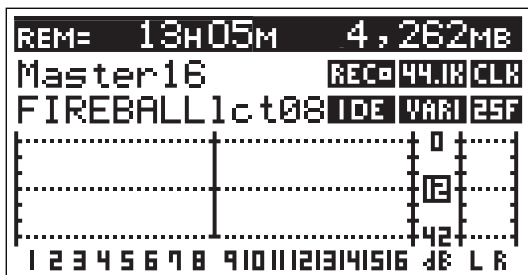

3. MTC Time Display Input

- * MTC time input.
“00H 00M 00S 00F” appears if there is no time input.
- * Program number and program title.
The first 9 characters of the program title are shown.
- * Scene number and scene name.
The first 9 characters of the scene name are shown.
- * Level meter of tracks 1 to 16.
- * L/R master level meter.



- *1. The REMAINING time display appears as follows according to the time base that has been selected.

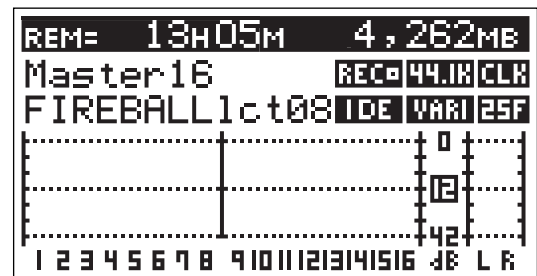

Time Base: ABS and MTC



Time Base: BAR/BEAT/CLK

- *2. Icons of the program setup details appear at the right side of the menu. Refer to examples below.

REC	This indicates recording/no recording setup by the “Rec Protect” menu. The icon shown here is indicating that it is presently set “Off” and thus recording is possible.
44.1K	This is indicating the VF-16 sampling frequency (Fixed to 44.1kHz).
IDE	This indicates the drive setup by the “Drive Sel” menu. The icon here is indicating that it is set to an “E-IDE hard disk.”
CLK	This indicates the MIDI sync output signal setup by the “Midi Sync Out” menu. The icon here is indicating that it is presently set to “CLK.”
VARI	This indicates the slave type setup by the “Slave Type” menu. This icon is indicating that it is presently set to “VARI.”
25F	Frame rate figure setup by the “MTC Frame Rate” menu is indicated here. The icon here is indicating that it is presently set to “25 Frames.”

Instructions for DIRECT Record

This section describes the basic REC/PLAY procedures in the "DIRECT" recording mode, which is the easiest recording procedure and also provides recordings that most closely resemble the original. Hints and tips to successfully operate the VF-16 are included according to the workflow, ranging from the actual recording to mix down process. Both experienced and novice users of multitracker should try this process so as to learn the VF-16 operations. The following description assumes that the VF-16 has been started up without any recordings.

Recording to One Track

Here, we will record to track 1 of the recorder. Check to see that the channel faders of ch1-16 and the master fader are set to $-\infty$ (completely down) and that [TRIM] A to H are set to LINE position (fully turn to left). Also use (connect) a headphone or monitor speakers to monitor the sound.

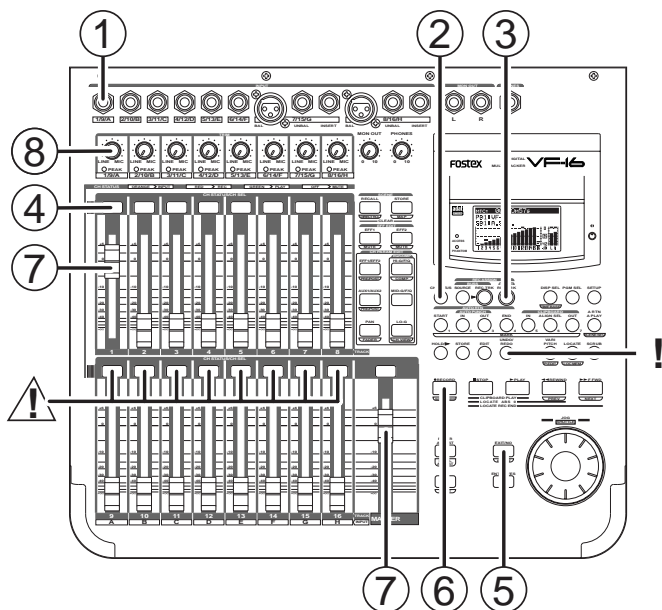

- Press the [CH STATUS/CH SEL] key of ch1 (Key: Flashing RED).

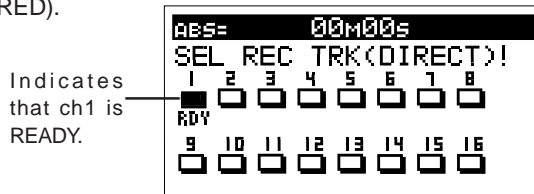

Indicates that ch1 is READY.

- Press the [EXIT/NO] key to return to the Normal Display. [CH STATUS/CH SEL] key of ch1 -> Alternately Flashes GREEN/RED
* Indicates that trk1 is "READY".
- Press [RECORD] key to set trk1 to the Input Monitor mode (Key: Flashing RED).
- Set the ch1 fader and master fader to "0".
- Output sound from the sound source while adjusting the [TRIM]1/9/A gain to an optimal level.

WARNING!

Be careful not to excessively raise the volume of the [MON OUT] or [PHONES] level. Prolonged exposure to loud sounds may have an adverse effect on hearing.

Tips: Changing the recording mode

To change the DIRECT recording mode to the BUSS recording mode, press the [BUSS-REC TRK] key while the tracks to be directly recorded are selected using the step above. "Rec Mode Change!" appears and "Sure?" flashes on the screen. Pressing the [ENTER/YES] key cancels the selection of tracks for the DIRECT recording and changes the display to the track selection screen for the BUSS recording.

Preparing to Record (refer to Figure above)

- Connect the sound source to record to the [INPUT] 1/9/A jack.
- Press the [INPUT SEL] key (Key: Flashes ORANGE). [CH STATUS/CH SEL] key of ch9-16 -> Flashes GREEN Indicates that all channels are [TRACK] (the following LCD display appears).

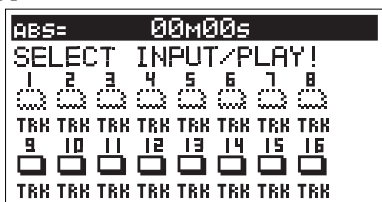

WARNING!

In DIRECT Recording, all channel faders are basically [TRACK]. If there is channel in which the [INPUT] (RED: Flashing), press the [CH STATUS/CH SEL] key of that channel so it is a [TRACK].

- Press the [DIRECT-REC TRK] key (RED: Flashing). The menu to select the track to record appears.



RECORD

- Press the [REWIND] key while the [STOP] key is depressed, to locate ABS 0 (Locate ABS 0).
- Press the [PLAY] key while the [RECORD] key is depressed to start recording. The RED light of [CH STATUS/CH SEL] key and [RECORD] key of ch1 lights up to indicate that ch1 is recording.

3. Press the [STOP] key to stop the recording operations. The LCD will show a "Please Wait" message and then return to the Normal Display.

This completes the process to record on track 1. Check the sound recorded using the following procedures.

PLAY

1. Press the [REWIND] key while the [STOP] key is depressed to locate ABS 0.
2. Press the [PLAY] key to start playback. The play level of track 1 can be adjusted with the ch1 fader. This concludes the procedures to check the sound recorded.

RECORDING to 2 Tracks

With track 1 now recorded, we will record the stereo sound source to tracks 15 and 16 of the recorder.

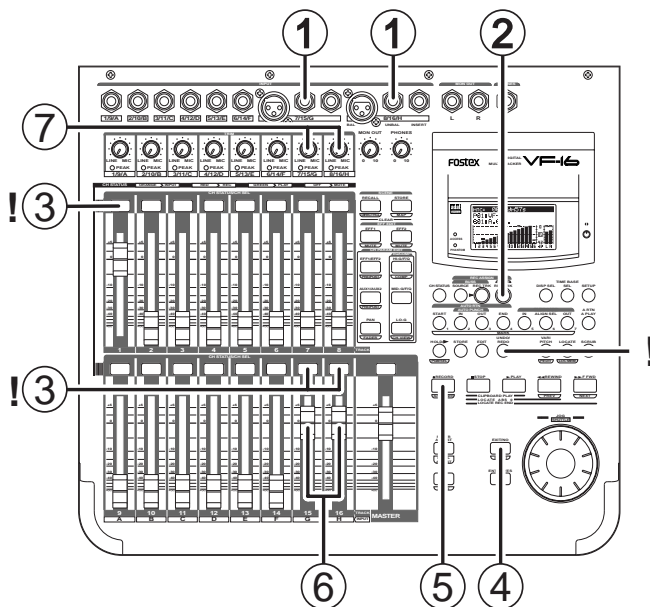

Preparing to Record

1. Connect the stereo sound source to record to [INPUT] jacks 7/15/G and 8/16/H.
2. Press the [DIRECT-REC TRK] key (RED: Flashing).
3. Press the [CH STATUS/CH SEL] key for ch15 and ch16 (RED: Flashing). Trk15 and 16 will go to the "READY" mode. The other tracks will be in the "SAFE" mode (Key: Light OFF).
4. Press the [EXIT/NO] key. [CH STATUS/CH SEL] key of ch 15 and 16 -> GREEN/RED: Alternately Flash
* Indicates that trk15 and 16 are "READY".
5. Press the [RECORD] key to put trk15 and 16 in the Input Monitor mode (RED: Flashing). Trk15 and 16 will go to the Input Monitor mode.

Cancel READY Status of Recording Track

Press once again the [DIRECT-REC TRACK] key that is lit up RED, then press the [CH STATUS/CH SEL] key of the channel that is in the READY mode to cancel the ready state of the track recorded and to put that track in the SAFE mode. Then press the [EXIT/NO] key to return to the Normal Display.

Tips: UNDO/REDO

Press the [UNDO/REDO] key after recording to return to the prerecording state (UNDO). Press the [UNDO/REDO] key again to return to the original state of the recording on track 1 (REDO). The UNDO/REDO function is effective for all recordings.

6. Set the ch15 and ch16 fader and master fader to "0".
7. Output sound from the sound source while adjusting the [TRIM] 7/15/G and 8/16/H gain to an optimal level.

RECORD

1. Locate the time to start recording.
2. Press the [PLAY] key while the [RECORD] key is depressed to start recording. The [CH STATUS/CH SEL] key and [RECORD] key of ch15 and 16 lights up RED to indicate that the channels are recording. By increasing the fader level of track 1, the user can record to tracks 15 and 16 (overdubbing) while listening to the playback sounds of track 1.
3. Press the [STOP] key to stop recording.

PLAY

1. Locate the time to playback.
2. Press the [PLAY] key to start playback. Ch1, ch15 and ch16 faders can be used to adjust the play level of each track.

After recording, put the "READY" track in the "SAFE" mode, as described earlier.

Tips: UNDO/REDO

Press the [UNDO/REDO] key after recording to return to the prerecording state (UNDO). Press the [UNDO/REDO] key again to return to the original state of the recording on two tracks (REDO).

Tips: MUTE

Press the [CH STATUS/CH SEL] key in the Normal Display to MUTE (silence) that channel ([CH STATUS/CH SEL] key: Light OFF).

DIRECT Recording

After reading the instructions up to this point, you are probably aware that the track recorded varies according to the input channel. With DIRECT Recording, the relationship between the channel input and track recorded are as follows.

- Connect to [INPUT] 1/9/A: Recordable on track 1/9.
- Connect to [INPUT] 2/10/B: Recordable on track 2/10.
- Connect to [INPUT] 3/11/C: Recordable on track 3/11.
- Connect to [INPUT] 4/12/D: Recordable on track 4/12.
- Connect to [INPUT] 5/13/E: Recordable on track 5/13.
- Connect to [INPUT] 6/14/F: Recordable on track 6/14.
- Connect to [INPUT] 7/15/G: Recordable on track 7/15.
- Connect to [INPUT] 8/16/H: Recordable on track 8/16.

[1/9/A], etc. also appears on the panel.

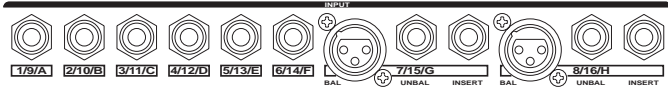

Based on the above, it is possible to simultaneously record 8 input channels with DIRECT Recording. Try recording to other tracks according to the procedures already explained.

WARNING!

- * It is also possible to simultaneously record 16 tracks. However, there will be 2 consecutive tracks on which the same sound is recorded.
- * The channel with the ORANGE light ON ([INPUT]) from among ch9-16 of the [CH STATUS/CH SEL] keys cannot output the audio sound on the tracks corresponding to 9-16, therefore, recording will be prohibited. As a result, the READY state cannot be established with the [DIRECT-REC TRK] key.

Locating a mark point using a Memory Key

You can store desired locate memory points using the Memory keys shown in the figure below. Each of the 6 keys shown in gray below can hold two memory points: one is primarily used as an edit point for track editing functions such as Auto return, Auto punch and Copy/paste, while the other is a locate memory point.

The edit point also can be used as a locate memory point when the corresponding editing function is not active.

The key shown in white below ([CLIPBOARD-ALIGN SEL/MARK 6]) can also hold two points but you can store only one point for a locate memory (MARK 6). The other point the key holds is the ALIGN SEL point, which is copied automatically from the point stored in the [CLIPBOARD IN] key when carrying out copy clip (or move clip) during the Copy/paste (or Move/paste).

Therefore, up to 13 locate memory points are available when no editing function is active. You can store memory points with any time base setting.

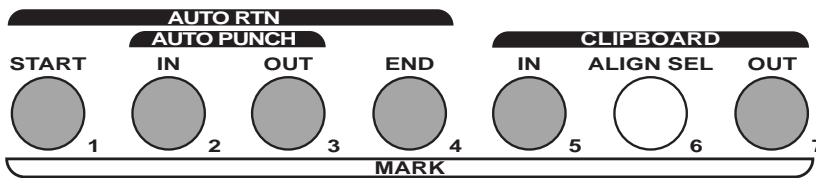

The following details are saved in each Memory Key.

- [AUTO RTN-START/MARK 1] Key -> START point and MARK 1 memory.
- [AUTO PUNCH-IN/MARK 2] Key -> PUNCH IN point and MARK 2 memory.
- [AUTO PUNCH-OUT/MARK 3] Key -> PUNCH OUT point and MARK 3 memory.
- [AUTO RTN-END/MARK 4] Key -> END point and MARK 4 memory.
- [CLIPBOARD-IN/MARK 5] Key -> CLIP IN point and MARK 5 memory.
- [CLIPBOARD-ALIGN SEL/MARK 6] Key -> ALIGN SEL point and MARK 6 memory.
- [CLIPBOARD-OUT/MARK 7] Key -> CLIP OUT point and MARK 7 memory.

Saving on the Memory key and Mark key

1. Ensure the system is in the PLAY or STOP status. Press the [HOLD/>] key at the time to save. The time is held on the LCD at the point the [HOLD/>] key is pressed.

```
LOCATE= 00H01M59S24F99SF
HOLD
```

2. Press the [STORE] key (RED: Light ON).

```
LOCATE= 00H01M59S24F99SF
Hit Any Memory Keys!
```

- 3-1. Press a voluntary Memory key. The time held is saved as a point of the Memory Key, and then the system returns to the Normal Display.
- 3-2. Press the [MARK 1-7] key while the [SHIFT] key is depressed. The time held is saved as a Mark Memory of MARK 1-7, and the system returns to the Normal Display.

Direct Location of Memory key or Mark key

- 1-1. Press a voluntary Memory key. The name of the key pressed and the point saved appears on the LCD.

```
LOCATE= 00H01M28S20F09SF
A.PUNCH IN
```

- 1-2. Press the [MARK 1-7] key while the [SHIFT] key is depressed. The name of the Mark Memory and the time saved appears on the LCD.

```
LOCATE= 00H01M28S20F09SF
MARK: 1
```

ABS Locate

There are 2 types of ABS Locate procedures. The instructions are described below.

- * Press the [REWIND] key while the [STOP] key is depressed to locate ABS 0 which is the head of the program. That head is located for all time bases.
- * Press the [F FWD] key while the [STOP] key is depressed to locate the REC end time of the last recording (REC END). This is a convenient feature to search the end of a song or to find out how long a song is. This Locate feature is available for all tracks from 1-24.

2. Press the [LOCATE] key. This allows Direct Location to the time shown.

Tips: PREROLL

By setting "PREROLL" in the SETUP mode, it is possible to locate the time (0-10 seconds) several seconds before the time set to locate.

Changing the Time Saved in the Memory key and Mark key

- 1-1. Press a voluntary Memory key. The name of the key pressed and the point saved appears on the LCD.

```
LOCATE= 00H01M28S20F09SF
A.PUNCH IN
```

- 1-2. Press the [MARK 1-7] key while the [SHIFT] key is depressed. The name of the Mark Memory and the time saved appears on the LCD.

```
LOCATE= 00H01M28S20F09SF
MARK: 1
```

2. Change the parameter of the flashing column (cursor) (H/M/S/F/SF or BAR/BEAT/CLK) using the [JOG] dial. Move the flashing column (cursor) by pressing the [HOLD/>] key.

3. Press the [STORE] key (RED: Light ON).

- 3-1. Press a voluntary Memory key. The time modified is saved as the time point of the Memory Key, and the system returns to the Normal Display.

- 3-2. Press the [MARK 1-7] key while the [SHIFT] key is depressed. The time modified is saved as a Mark Memory of MARK 1-7, and the system returns to the Normal Display.

Locating an event memory

You can store up to 99 event memory points (00 to 99). These are used for the “Skip locate” function, as well as for the Scene event map described later in “Chapter 3. Advanced mixer operations.”

Creating an event memory

- At the desired position while the VF-16 is stopped or during playback, press the [HOLD/>] key.
The time when pressing the [HOLD/>] key is held on the screen.



- Press the [STORE] key.
The key lights up (in red) and “Hit Any Memory Keys!” appears on the screen.



- Press the [LOCATE/EVT MEM] key while holding down the [SHIFT] key.
“Entry EVT**” (where ** shows the number) appears for a short time, while the time held in step 1 is entered in the event memory.

<Hint>

Event memory numbers are assigned in ascending order of ABS time, regardless of order in which event memories are created.

For example, if you create event memories in order as shown in the upper diagram below, the event memory numbers are assigned as shown in the lower diagram.

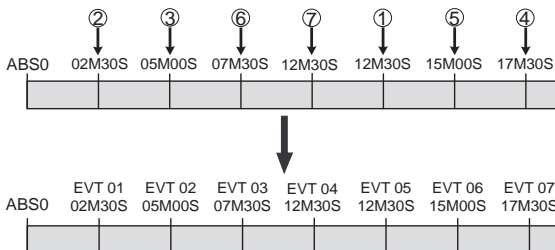

- Rotate the [JOG] dial to scroll through the event memory list.
- After viewing the screen, press the [EXIT/NO] key.
The display returns to the Normal display.

<Hint>

You can delete unnecessary event memories. See “Editing the event map” in “Advanced mixer operations” described later for details.

Skip locate

With the Skip locate function using the event memories, the unit automatically recognizes the locate point and locate there.

When the Skip locate is executed, the locate point is shown on the screen and you will know where the current position goes.

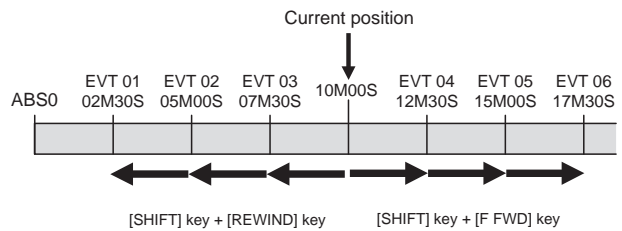

- Press the [REWIND/PREV] key while holding down the [SHIFT] key to skip back to the previous event memory point.
- Press the [F FWD/NEXT] key while holding down the [SHIFT] key to skip advance to the next event memory point.

Viewing the event memories

- Press the [SCENE-STORE/MAP] key while holding down the [SHIFT] key.
The display shows the event number select screen for the scene event map, in which you can view and check the event memories created by the procedure above.
The unit for event memories - ABS, Bar/Beat/Clk or MTC - depends on the time base setting.

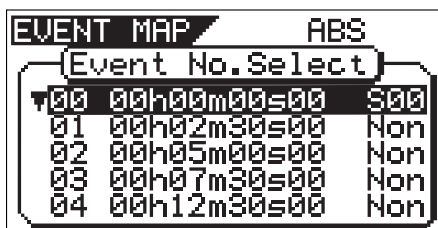

PUNCH IN/OUT

Punch IN/OUT recording enables you to record over previously recorded parts. This function comes in handy in the following cases.

- * If a recording is unsatisfactory in either recording or performance and you want to redo it.
- * If you want to record a solo part to another track while listening to the backup tracks.

PUNCH IN refers to the process to switching from PLAY to REC. On the other hand, PUNCH OUT refers to the reverse process, to switch from REC to PLAY. The time to punch in is called the PUNCH IN point, and the time to punch out is called the PUNCH OUT point. The VF-16 features the following 3 types of PUNCH IN/OUT modes.

* MANUAL PUNCH IN/OUT using the key on the main unit

This feature is used for rough recordings. Manual punch in/out is not recommended during a performance since the process requires using your hands.

* PUNCH IN/OUT using the foot switch

Recording is possible even during a performance since all punch in/out processes are controlled from the foot switch.

* AUTO PUNCH IN/OUT

Detailed recording is possible since recording takes place with the punch in/out time preset (programmed) prior to the recording.

Use the [DIRECT-REC TRK] key to put the track to record in the READY mode. The [TRIM] must be adjusted to an optimal gain according to the input monitor. When this is set, do the following:

Manual Punch IN/OUT

1. Press the [PLAY] key from the point immediately before starting the recording and then playback.
2. Press the [RECORD] key while the [PLAY] key is depressed to start recording (punch in).
3. Recording is canceled and playback takes place if only the [PLAY] key is pressed (punch out).

Punch IN/OUT with Foot switch

1. Connect a "Fostex Model 8051" foot switch to the [FOOT SW] jack on the rear panel of the VF-16.
2. Press the [PLAY] key from the point immediately before starting the recording, then playback.
3. Recording starts by stepping on the foot switch (punch in).
4. Recording is canceled and playback takes place when the foot switch is stepped on again (punch out).

Tips: Rehearsal

Step on the foot switch while the [STOP] key is depressed to start rehearsing the recording ("Rhrsl On" will appear on the LCD then "RHSL" will light ON).

```
ABS= 00M00s
P01:#0001
S00:Init Mix RHSL
```

flashing

Rehearsal instructions are the same as recording with the foot switch.

However, stepping on the foot switch will go to input monitor, and stepping on it again will cancel it. To cancel the rehearsal mode, step on the foot switch again while the [STOP] key is depressed ("Rhrsl Off" will appear on the LCD then "RHSL" will light OFF).

Auto Punch IN/OUT

* Programming the PUNCH IN/OUT points

1. While the system is in the PLAY or STOP mode, press the [HOLD/>] key at the time to program as the PUNCH IN or PUNCH OUT point.

```
LOCATE= 00H01M59S24F99SF
HOLD
```

2. Press the [STORE] key (RED: Light ON).

```
LOCATE= 00H01M59S24F99SF
Hit Any Memory Keys!
```

3. The PUNCH IN point is programmed when the [AUTO PUNCH IN] key is pressed. The PUNCH OUT point is programmed when the [AUTO PUNCH OUT] key is pressed.

Tips:

When programming a PUNCH IN/OUT point, the time of the punch IN point must always be before the time of the PUNCH OUT point. If the PUNCH OUT point precedes the PUNCH IN point, a [Void Out!] error message appears on the LCD and prevents use of the AUTO PUNCH mode.

* AUTO PUNCH IN/OUT recording

1. Press the [RECORD] key while the [SHIFT] key is depressed to go to the "AUTO PUNCH Mode".

```
ABS= 00M00s
P01:#0001
S00:Init Mix RHSL
```

2. LOCATE the point immediately before starting the recording.
- 3-1. The recordings are rehearsed if only the [PLAY] key is pressed.
- 3-2. Press the [RECORD] key while the [PLAY] key is depressed to start recording [TAKE].

Track Exchange

Up to now, we changed the input channel according to the track to record. However, there is also a way to record all tracks with one input jack. You can do this by exchanging a recorded track that was recorded normally with an unrecorded track. This procedure is called “Track Exchange”.

This feature is convenient to use when recording with all G and H [INPUT] jacks that can be connected with a condenser mic or balanced output, for example. Note that the VF-16 comes with 16 tracks, plus 8 additional tracks. The Track Exchange feature makes it possible to exchange these tracks with any unneeded tracks 1-16.

Instructions

For this procedure, you need a recorded track and a blank track.

1. Repeatedly press the [EDIT] key while the recorder is in the STOP state to find and display the “Track Exchange” mode.

The mode can also be selected by pressing the [EDIT] key then turning the [JOG] dial.



2. Press the [ENTER/YES] key. The track selection menu of the Track Exchange mode appears.



3. Turn the [JOG] dial to select the track to exchange from. Mono tracks from trk 1-24 and the 8 tracks from 01-08 are selectable.

4. Press the [HOLD/>] key, then move the cursor to the track to exchange to.

The cursor moves every time the [HOLD/>] key is pressed. The cursor can also be moved using the [REWIND] key or [F FWD] key.

5. Turn the [JOG] dial to select the track to exchange to. If the track to exchange from is 01-08 then tracks 09-16 or 17-24 are selectable. Mono tracks can be selected as the exchange site if the tracks are exchanged from the mono track.

6. Press the [ENTER/YES] key. [Exchange] appears on the LCD and the exchange process takes place instantaneously. [Completed!] appears on the LCD when the exchange process is completed. Then the system returns to the Normal Display.



Tips:

“Select Err!” appears on the LCD and the exchange process is invalidated if the same track is selected for the track to exchange from and track to exchange and [ENTER/YES] is pressed. (Ex: 3<->3 and so on)

Mixing

After recording with DIRECT Recording, adjust the play level, equalize the sound or add some effects to the audio sound of track 1-16. This section describes how to adjust the level, PAN, equalizer, effect send level and effect.

Level Adjustment

- * Use the Channel Fader to adjust the play level of each channel.
- * Use the Master Fader to adjust the stereo OUT level of the output signal of the sounds mixed.

Tips: Master Level

Check the stereo OUT level with the L/R level meter on the LCD. If the output level is too high, the output will distort. Adjust the Master Fader so it does not exceed 0 on the L/R level meter.

PAN Adjustment

1. Press the [PAN] key. The PAN setup menu appears on the LCD. “Select CH!” will be flashes.

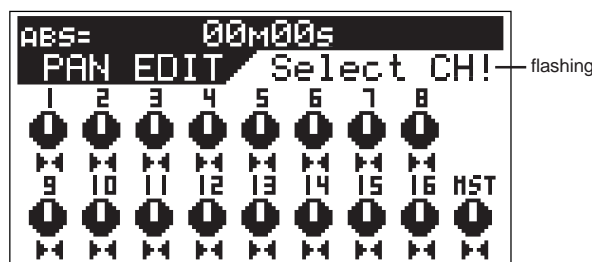

2. Press the [CH STATUS/CH SEL] key of the channel intended for PAN adjustment.
The channel selected flashes, then the input signal and the current setting of the channel selected appears on the LCD.
3. Turn the [JOG] dial to set the PAN level.
A graphic display of the PAN parameter appears on the LCD in real-time.
4. To adjust other channels, press the [CH STATUS/CH SEL] key of that channel, then go to Step 3.
5. Press the [EXIT/NO] key when adjustments are completed.
The system returns to the Normal Display.

Equalizer Adjustment

- 1-1. Press the [HI-G/F/Q] key.
The menu to set the high frequencies of the equalizer appears.
- 1-2. Press the [MID-G/F/Q] key.
The menu to set the mid frequencies of the equalizer appears.
- 1-3. Press the [LO-G] key.
The menu to set the low frequencies of the equalizer appears.

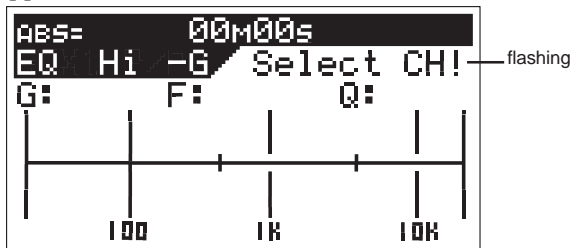

2. Press the [CH STATUS/CH SEL] key of the channel intended for equalizer adjustments.
The channel name and current setting of the channel selected appears on the LCD.
3. Every time the [HI-G/F/Q] key or [MID-G/F/Q] key is pressed the parameter alternates from G (Gain) -> F (Frequency) -> Q (Characteristic Curve). Select the item to adjust.
Only the G (Gain) can be adjusted for the low frequency equalizer ([LO-G] key). Therefore, the item will not change by pressing the key.
4. Turn the [JOG] dial to modify the parameter of the item to adjust.
The EQ setting graphically appears on the LCD in real-time.
5. To adjust other items or another frequency range of the equalizer, press again the [HI-G/F/Q] key, [MID-G/F/Q] key or [LO-G] key. Then turn the [JOG] dial to modify the parameter.
6. To adjust other channels, press the [CH STATUS/CH SEL] key of that channel.
7. When adjustments are completed, press the [EXIT/NO] key.
The system returns to the Normal Display.

Effect Send Level Adjustment

1. Press the [CH PARAM EDIT-EFF1/EFF2] key.
Every time the key is pressed the mode alternates between the EFF1 and EFF2 menu.



2. Press the [CH STATUS/CH SEL] key of the channel intended to adjust the effect send level.
The channel name and current setting of the channel selected appears on the LCD. Press the [MASTER CH STATUS/CH SEL] to adjust the master send level.
3. Turn the [JOG] dial to set the effect send level.
4. To adjust other channels, press the [CH STATUS/CH SEL] key of that channel.
5. When adjustments are completed, press the [EXIT/NO] key.
The system returns to the Normal Display.

Modifying Effect Type

- 1-1. Press the [EFF EDIT-EFF1] key.
The effect 1 selection menu appears along with the currently set effect type.
- 1-2. Press the [EFF EDIT-EFF2] key.
The effect 2 selection menu appears along with the currently set effect type.

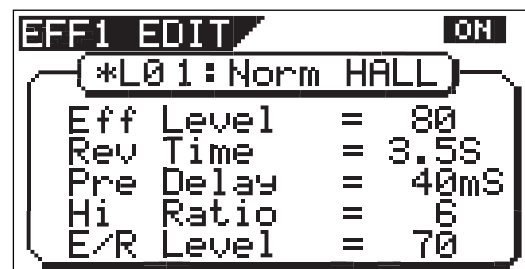

Example: Display when the [EFF EDIT-EFF1] key is pressed.

2. Turn the [JOG] dial to select the effect type.
3. Press the [ENTER/YES] key.
The mode switches to the effect selected.
It is possible to adjust the parameters of the effect in this state. The parameter settings alternate every time the [EFF EDIT-EFF1] key or [EFF EDIT-EFF2] key is pressed. Turn the [JOG] dial to modify the parameters. Only the effect type is modified here. For more details refer to a later section.
4. When adjustments are completed, press the [EXIT/NO] key several times.
The system returns to the Normal Display.

Mix Down

Create the master tape after adjusting all tracks. Start recording the piece with a master recorder (cassette tape, DAT, MD, etc.). The VF-16 can output S/P DIF (optical) digital signals making it is possible to directly mix down digital signals if the master recorder can input S/P DIF (optical) digital signals.

Analog Mix Down

1. Connect the IN (input jack) of the master recorder with the [ST OUT-L/R] jack of the VF-16.
2. Adjust the recording level of the master recorder.
3. Start recording with the master recorder and then play the song on the VF-16 from the beginning.
4. Stop both machines when recording is completed.

Tips: Fade IN/OUT

The VF-16 Master Fader provides a feature to Fade IN (gradually increase the volume) or Fade OUT (gradually decrease the volume) the sound.

Digital Mix Down

1. Connect the digital IN (input jack) of the master recorder with the [DIGITAL/DATA OUT] jack of the VF-16.
 - * Direct connection is possible if the master recorder has a S/P DIF (optical) digital input.
 - * Use the “Fostex COP-1/96k” for connections if the master recorder has a S/P DIF (coaxial) digital input jack.
2. Prepare the master recorder to accept digital input.
 - * The sampling frequency of the VF-16 is 44.1kHz. Digital mix down is not possible unless the master recorder can record 44.1kHz digital signals.
 - * Generally speaking, the input level of the master recorder is not adjustable for digital input.
3. Fine tune the output level of the VF-16 master fader.
 - * In General, the optimal level is when the level meter of the master recorder is 0 at the maximum volume of VF-16. Note that any level exceeding 0 may cause sound distortion.
4. Start recording with the master recorder and then play the song on the VF-16 from the beginning.
5. Stop both machines when recording is successfully completed.

Tips: Fade IN/OUT

The VF-16 Master Fader provides the feature to Fade IN (gradually increase the volume) or Fade OUT (gradually decrease the volume) the sound.

Instructions for recording with BUSS RECORD

This section will discuss the basic procedures to REC/PLAY with "BUSS" RECORD, which is another recording option. With DIRECT RECORD, the track recorded was determined according to the input of channel A to H. However, with BUSS RECORD, recording is possible regardless of the channel input. It is also possible to record the input of all 8 channels on 2 tracks with BUSS RECORD. Since the recording process takes place via the mixer, it is possible to apply equalizer and effect sound to the recording.

Note that BUSS RECORD takes place using the REC exclusive "REC BUSS". This "REC BUSS" consists of 2 channels, L and R, therefore, a maximum of 2 tracks can be recorded at the same time.

Description of BUSS RECORD

BUSS RECORD takes place by sending signals processed through the mixer to the "REC BUSS" for recording. Therefore, signals applied with equalization and built-in effect can be recorded (added and recorded). Here, we will use the channel (ORANGE) with an [INPUT] started with the fader as the source channel. However, channels (GREEN) in which [TRACKS] are started can also be used as a source channel. Ping-pong recording is possible for the source channel recording with the [TRACK] started channel (GREEN). Note the following precautions for BUSS recording.

WARNING!

Of the [CH STATUS/CH SEL] key of ch9-16, a channel with an "INPUT" which is lit up ORANGE, cannot output sound of the tracks corresponding to ch9 to 16, so it is not possible to go to the READY state using the [BUSS-REC TRK] key.

WARNING!

Precautions for when selecting a source channel with the [BUSS-SOURCE] key. (when key is flashing in GREEN)

- * A channel in which the [CH STATUS/CH SEL] key light is OFF is selectable.
- * The channel selected will either have a flashing ORANGE or GREEN [CH STATUS/CH SEL] key.
- * The [CH STATUS/CH SEL] key that is flashing RED is a READY channel (track) and cannot be selected.

WARNING!

Precautions when selecting a REC track with the [BUSS-REC TRK] key. (key is flashing RED)

- * A channel in which the [CH STATUS/CH SEL] key light is OFF is selectable.
- * The channel selected has a flashing RED [CH STATUS/CH SEL] key.
- * The [CH STATUS/CH SEL] key that is flashing ORANGE or GREEN is selected as a source channel, therefore, it cannot be selected.

Recording the H Input Signal to Track 1

Here we will record a sound source connected to input H on track 1 of the recorder. Beforehand, set the ch1 to 16 channel faders, master fader and the [TRIM] for A to H to 0. Connect a headphone or speaker to monitor the sound.

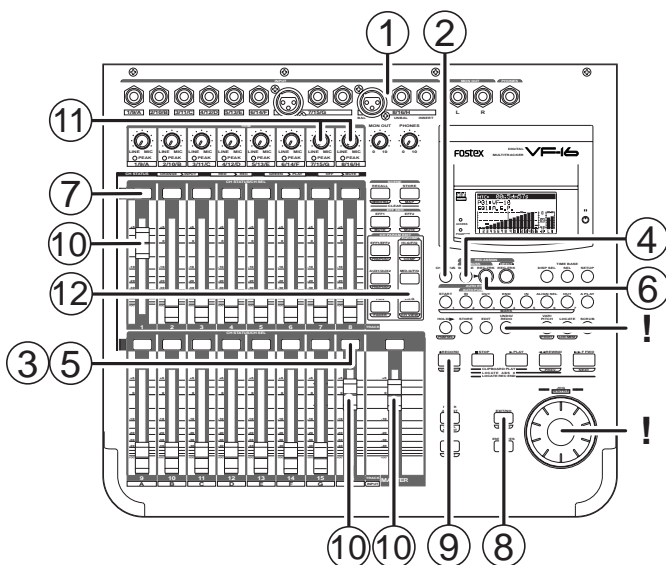

Channel Selection

1. Connect the sound source to record to [INPUT] jack H.
2. Press the [INPUT SEL] key (ORANGE: Flashing).

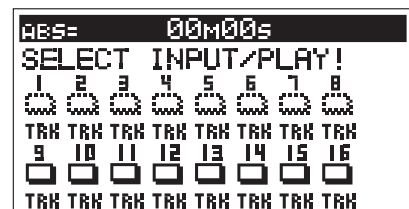

3. Press the [CH STATUS/CH SEL] key for ch16 so the key starts "flashing ORANGE (=INPUT)".

The following display appears, and the signals of input H will start for channel 16.

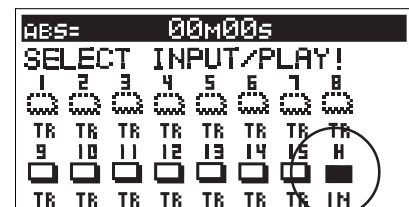

- Press the [BUSS-SOURCE] key (GREEN: Flashing).
The display to select the source channel sent to REC BUSS appears.

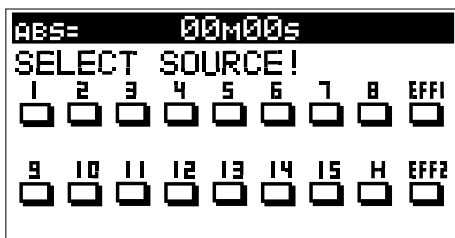

- Press the [CH STATUS/CH SEL] key of ch16 (ORANGE: Flashing).
The signals of input H started with the fader of ch16 is sent to REC BUSS.

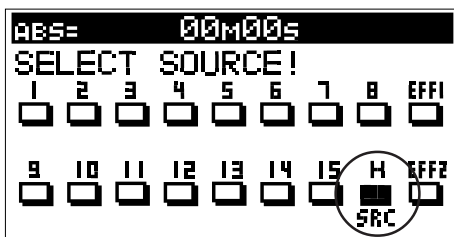

It is possible to apply effect to the input signals by setting EFF1 or EFF2 to the source at the same time. Details are described later.

<Note>

The channel signal sent to REC BUSS (ch16 in this case) are not directly output from the stereo OUT L/R channels. It will be output from the stereo OUT L/R channels with the track recorded set to the input monitor mode, with later procedures.

- Press the [BUSS-REC TRK] key (RED: Flashing).
The display to select the REC track appears.

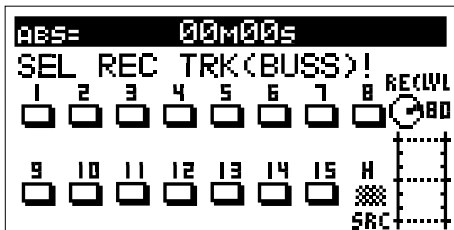

<Note>

When the signals of input H are started with the ch16 fader, it will not be possible to listen to the play sound of the track. Therefore, it is prohibited to put track 16 in the READY (REC) mode.

- Press the [CH STATUS/CH SEL] key of ch 1 (RED: Flashing).
Track 1 will go to the "READY" state, and allow the input signal of source channel H to be recorded to track 1.

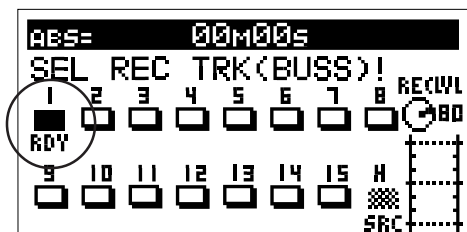

- Press the [EXIT/NO] key to return to the Normal Display.

Tips: Changing the recording mode

To change the BUSS recording mode to the DIRECT recording mode, press the [DIRECT-REC TRK] key while the tracks to be directly recorded are selected in the step above. "Rec Mode Change!" appears and "Sure?" flashes on the screen. Pressing the [ENTER/YES] key cancels the selection of tracks for the BUSS recording and changes the display to the track selection screen for the DIRECT recording.

Adjusting the Source Channel

- Press the [RECORD] key, then set track 1 to the input monitor ([RECORD] Key: RED Flashing).
Sound for monitoring purposes can be heard from the headphones or speakers from this point. Adjust the volume of the monitor sound with the [MON OUT] or [PHONES] knob.
- Set the ch1 fader, ch16 fader and master fader to "0".
- Check the sound source and adjust the [TRIM] 8/16/H to an appropriate gain.
The guideline for optimal gain is when the [PEAK] LED is just about to light up when the sound source is turned up to the maximum volume.
- Accordingly, equalize the signals of ch16 being recorded.

Tips: Equalizing the Source Channel

Press the [HI-G/F/Q] key, [MID-G/F/Q] key or [LO-G] key and switch to channel parameter edit EQ edit mode to equalize the source channel to record. Then, press the [CH STATUS/CH SEL] key of ch16 to adjust the sound with a customized equalization (For more details refer to "Adjusting the Equalizer").

- The final REC level (REC BUSS Master Level) is adjusted according to the following instructions.
After adjusting the master level, press the [EXIT/NO] key to return to the Normal Display.

Tips: Adjusting the REC BUSS Master Level

Turn the [JOG] dial with the system showing the following display to make the final adjustments for the REC BUSS Master Level. Press the [BUSS-REC TRK] key once more to switch to this display from the Normal Display. The default setting of the REC BUSS Master Level is factory preset to level "80". Use the JOG dial to turn the [REC LVL] knob on the LCD as shown below, and adjust the number setting in real-time. The REC BUSS Master Level can also be adjusted (adjustable range: 00-99).

REC BUSS Master Level adjustment icon

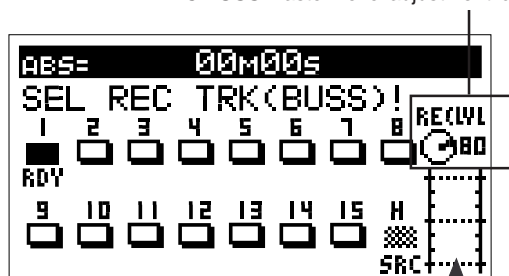

REC BUSS Master Level appears

Tips: Adjusting the PAN Setting of the Source Channel
 When recording on one track with the BUSS RECORD option, the PAN setting of the source channel is either fixed to the left or right.
 If the REC track is an odd number, the source channel PAN is fixed all the way to the left. If the REC track is an even number, the source channel PAN is fixed all the way to the right. The source channel PAN can be optionally set ONLY when there are two REC tracks set.

These procedures complete the instructions to record to track 1 with the BUSS recording option.

Tips: UNDO/REDO

By pressing the [UNDO/REDO] key after recording, the recording is undone and the track returns to the pre-REC state where there is no recording (UNDO). By pressing the [UNDO/REDO] key again, the recording on track is redone to the post-REC state (REDO).

Recording

1. Locate the time to start recording on the VF-16.
2. Press the [PLAY] key while the [RECORD] key is depressed to start recording.
 The [CH STATUS/CH SEL] key and [RECORD] key of ch1 lights up RED, indicating that recording is taking place.
3. Press the [STOP] key when recording is completed, to stop the VF-16.
 "Please Wait" will appear on the LCD, then return to the Normal Display.

Play

1. Locate the time in which recording was started (REC start time).
2. Press the [PLAY] key to check the sound recorded.
 The ch1 fader can be used to adjust the play level.

The signals recorded on track 1 can be checked.

Recording 8 INPUTs to Tracks 7 and 8

Here we will record all 8 sound sources connected to inputs A to H to tracks 7 and 8 of the recorder.

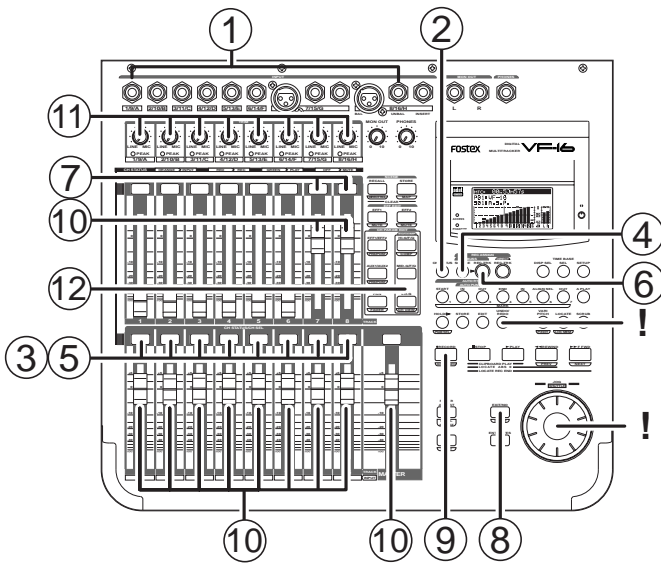

<Note>

If input signals are started for ch9-16 faders, the play sounds of the corresponding track can no longer be heard and you cannot go to the READY (REC) state.

4. Press the [BUSS-SOURCE] key. (GREEN: Flashing)
5. Press the [CH STATUS/CH SEL] key of ch 9-16. (ORANGE: Flashing)
 Signals of input A to H can now be sent to REC BUSS.

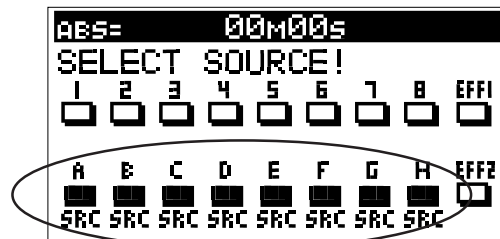

Preparing to Record

1. Connect to the [INPUT] jack the sound source to record.
2. Press the [INPUT SEL] key.
3. Press the [CH STATUS/CH SEL] key of ch9-16 to switch ch 9-16 to "INPUT".
 Ch9-16 is ready to start signals of input A to H.

6. Press the [BUSS-REC TRK] key (RED: Flashing).
7. Press the [CH STATUS/CH SEL] key of ch7 and 8 (RED: Flashing).
 Track 7 and 8 will proceed to the "READY" state.

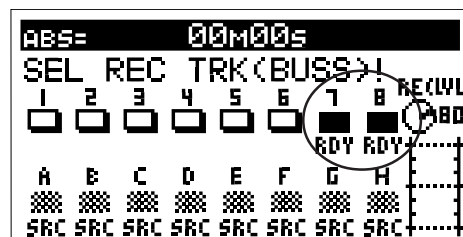
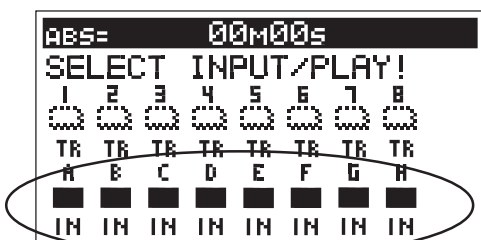

8. Press the [EXIT/NO] key to return to the Normal Display.

Adjusting the Source Channel

9. Press the [RECORD] key and set tracks 7 and 8 to the input monitor (RED: Flashing).
As in the earlier case, the monitor sound is output at this stage. Adjust the volume of the monitor sound with the [MON OUT] or [PHONES] knob.
10. Set the ch7&8 fader, ch9-16 fader and master fader to 0.
11. Output the sound of the sound source to record and adjust the [TRIM] to an appropriate gain.
The guideline for optimal gain is when the [PEAK] LED is about to light when the sound source is turned up to the maximum volume.
12. Accordingly, equalize the signals of ch9-16 being recorded and/or adjust the PAN according to the sound source.
Refer to the earlier section for instructions on adjusting the equalizer.

Tips: Adjusting the PAN Setting of the Source Channel
It is possible to set the PAN according to the sound source of the source channel when recording to two tracks. Press the [PAN] key to switch to the PAN setting display. Select the channel to adjust the PAN setting with the [CH STATUS/CH SEL] key. Then use the [JOG] dial to optionally set the PAN setting.

13. The final REC Level (REC BUSS Master Level) is adjusted according to the earlier mentioned procedures.

The system is ready to record after you have completed the above procedures.

Record

1. Locate the time to record on the VF-16.
2. Press the [PLAY] key while the [RECORD] key is depressed to start recording.
The [CH STATUS/CH SEL] key and the [RECORD] key of ch7&8 lights up RED, indicating that recording is taking place.
3. Press the [STOP] key when the recording is completed, to stop the VF-16.
"Please Wait" appears on the LCD and then returns to the Normal Display.

This completes recording the sound source of inputs A to H on tracks 7 and 8.

Tips: UNDO/REDO
By pressing the [UNDO/REDO] key after recording, the recording is undone and the track returns to the pre-REC state where there is no recording (UNDO). By pressing the [UNDO/REDO] key again, the recording on two tracks are redone to the post-REC state (REDO). The UNDO/REDO feature is available for all recordings.

Play

1. Locate the time in which recording was started (REC start time).
2. Press the [PLAY] key to play the VF-16.
Adjust the play level of tracks 7 and 8 with the ch7&8 faders to check (listen to) the sound recorded.

Tips: Applying an Effect on the Source Channel
It is possible to apply effect sound on the source channel during BUSS RECORD.

1. EFF1 or EFF2 can also be selected at the same time for the source channel from the display (appears by pressing the [BUSS SOURCE] key) to select the source channel, as described earlier.
The following figure shows the example where input H and EFF1 are both applied to the source channel, and allows EFFECT 1 to be applied to the input H signals.

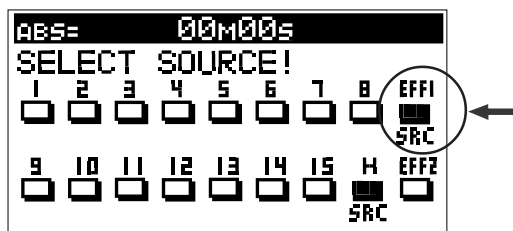

2. Press the [CH PARAM EDIT-EFF1/EFF2] key to adjust the send level of effect 1.
Press the [CH STATUS/CH SEL] key of ch16, select input H and use the [JOG] dial to adjust the send level of input H. The signal level adjusted here is sent to effect 1. To adjust the master send level, use the [CH STATUS/CH SEL] key of the master channel to select the master send level and adjust it with the [JOG] dial.

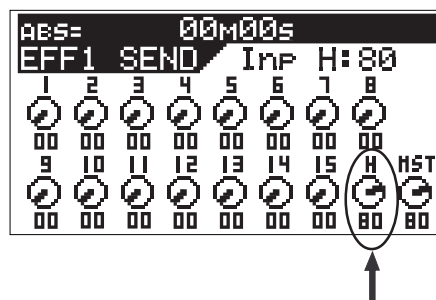

3. Press the [EFF EDIT-EFF1] key, select the effect type desired and then edit the effect parameter. It is possible to apply the selected effect on the sound recorded.

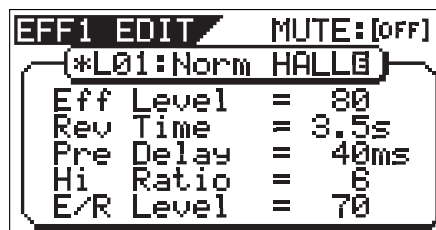

Tips:
It is possible to apply different effects (EFF1/EFF2) on multiple source channels by individually tuning the signal level sent to EFFECT1/EFFECT2, upon adjusting the above effect send level.

Chapter 3 Advanced mixer operations

This section describes practical operations of the mixer including functions that are not described in "Basic operations" as well as detailed information about settings.

Initial condition when the power is turned on

When you turn the power on, the VF-16 shows the start-up display ("FOSTEX" -> "Initial.." -> "Current DR", "IDE" -> "Format Type" ["Standard" or "Quick"]), and then becomes ready. In this condition, only the [CH STATUS/CH SEL] key, [STOP] key, [EFF 1] key, and [EFF 2] key light on the panel, while the display looks as shown below. In this manual, we refer to this display as the "Normal display", in which you can see the current recorder position is at the beginning (ABS 00M 00S) of the program 1 (P01).

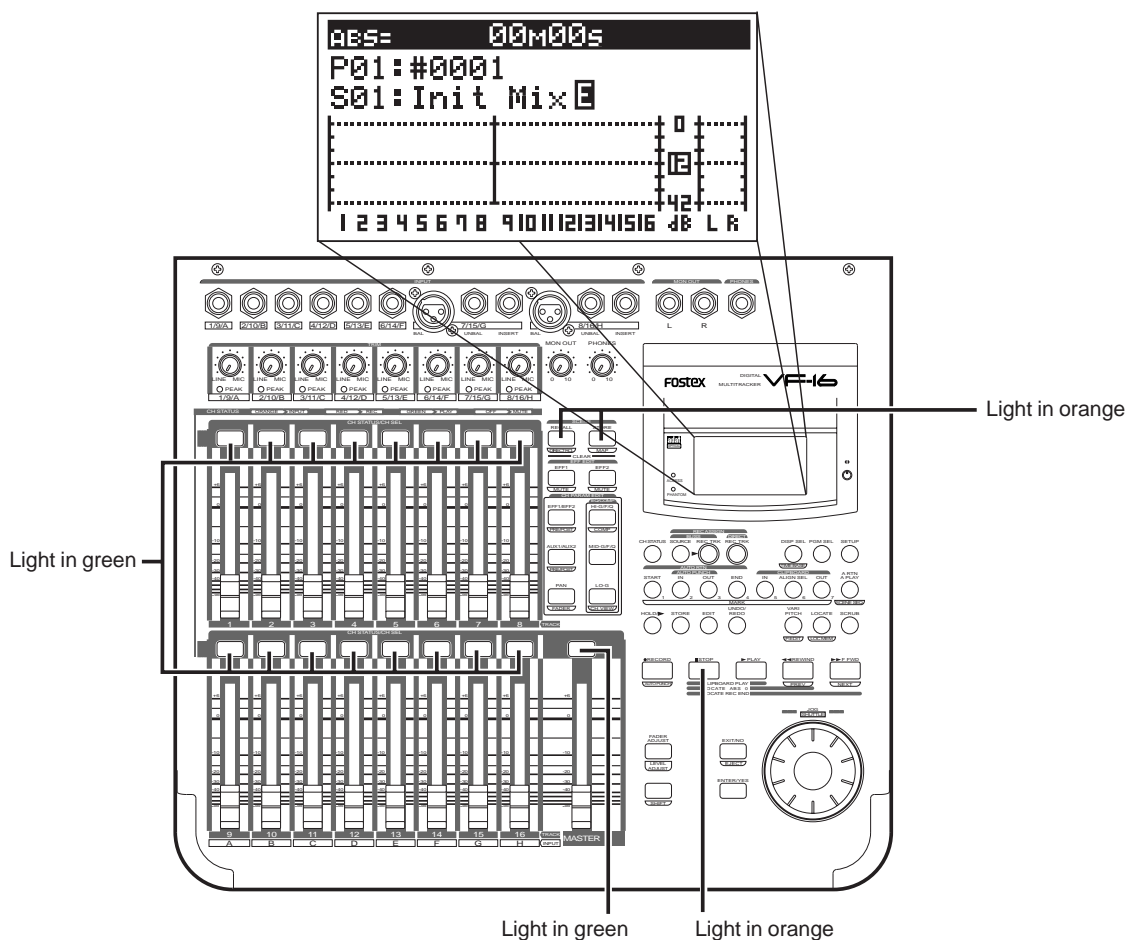

Operations while the Normal display is shown

Fader

The fader for each channel (1 through 16) controls the level of TRACK or INPUT signal fed to the stereo output or the Rec busses.

The master fader controls the total level of the stereo output busses.

Channel mute

While the Normal display is shown, pressing a [CH STATUS/CH SEL] key mutes the corresponding channel.

The [CH STATUS/CH SEL] key for the muted channel is unlit. Pressing the key again releases muting and lights the key.

Master channel mute

While the Normal display is shown, pressing a [CH STATUS/CH SEL] key for the master channel mutes the stereo output signals. The [CH STATUS/CH SEL] key of the master channel is unlit.

Pressing the key again releases muting and lights the key.

Channel parameter edit

You can edit the various parameter settings such as pan and equalizers for channels 1 through 16 and the master channel. We refer this type of editing as "Channel parameter edit". There are several channel parameter edit keys on the top panel (as shown below) and pressing the dedicated key for the parameter you want to edit brings up the corresponding edit screen. Some keys also handle the second parameter (labeled under the key) and you can bring up the corresponding edit screen by pressing the key while holding down the [SHIFT] key. You can view and/or edit the following parameters.

- Pan setting
- 3-band equalizer setting
- Effect send level setting
- Pre/post selection of the effect send
- Aux (auxiliary) send level setting
- Pre/post selection of the Aux (auxiliary) send
- Compressor setting
- Fader level setting
- Channel view (viewing only)

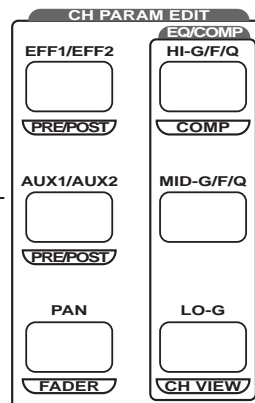

<Hints>

If a channel whose source is set to INPUT via the INPUT SEL setting is selected as the edit channel, the channel name is shown as below.

In the following example, channel 9 which is set to INPUT, is selected as the edit channel.

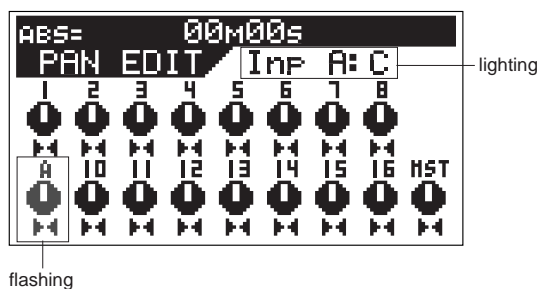

2. Press the [CHA STATUS/CH SEL] key of the desired channel.
The current settings are shown, together with the selected channel name. The icon for the selected channel is flashing, indicating that you can edit it.

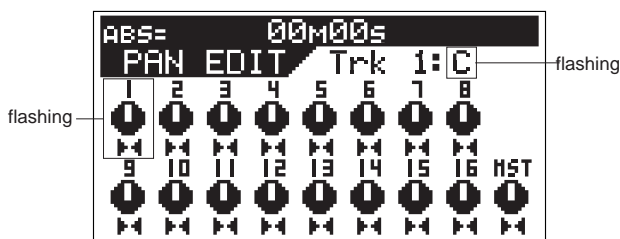

3. Use the [JOG] dial to adjust panning.
Rotating the [JOG] dial to the left or right moves the pan position to the left or right respectively. The following show examples of the pan settings.

Pan position: center	Pan position: hard left	Pan position: hard right
<ul style="list-style-type: none"> •Controllable channels Channels 1 through 16 and the master channel •Available values L10 (hard left) through C (center) to R10 (hard right) (the default setting: "C" for all channels) <p>* Values are displayed between L10 and R10 in 21 steps but the actual pan setting is changed smoothly and continuously as rotating the [JOG] dial.</p>		

Adjusting Pan

You can adjust the pan (or balance) of each input channel signal fed to the stereo outputs, as well as fed to the Rec buss outputs. The panpot for master channel controls the L/R level balance of the stereo outputs.

1. Press the [PAN] key.
All channel settings are shown on the screen. The first time you bring up the channel parameter edit screen, the message prompting to select a channel ("Select CH!") flashes, as well as all the CH STATUS/CH SEL indicators on the panel flash. From the second time on, the previously selected channel is selected and ready to be edited when bringing up the screen (as shown in the drawing of step 2 below).

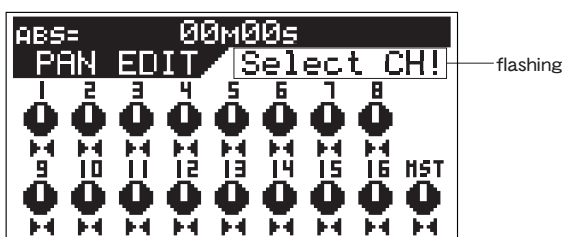

4. To set another channel's pan, repeat steps 2 and 3 above.
5. After completing pan editing, press the [EXIT/NO] key. The VF-16 exits the channel edit mode and the display returns to the Normal display.

Adjusting EQ

The VF-16 provides a 3-band equalizer section including HI, MID and LO bands. You can control G (gain), F (frequency) and Q for HI and MID equalizers, while only G (gain) for LO.

<Note>

If channels 13-14 or 15-16 are specified as the compressor channels via "Setting the compressor channels" in the Setup mode, you cannot apply the equalizer to those channels. If you press a [CH STATUS/CH SEL] key of the compressor channel, a warning message ("Can't Select!") flashes and the operation is cancelled. In the screen example shown below, the compressor is applied to channels 13-14.

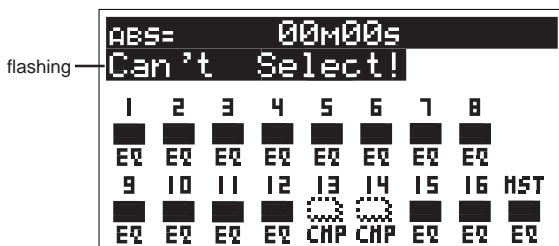

1. Press the [HI-G/F/Q] (or [MID-G/F/Q] or [LO-G]) key. The first time you bring up the channel parameter edit screen, the message prompting to select a channel ("Select CH!") flashes, as well as all the CH STATUS/CH SEL indicators on the panel flash. From the second time on, the previously selected channel is selected and ready to be edited when bringing up the screen as shown in the drawing of step 2 below.

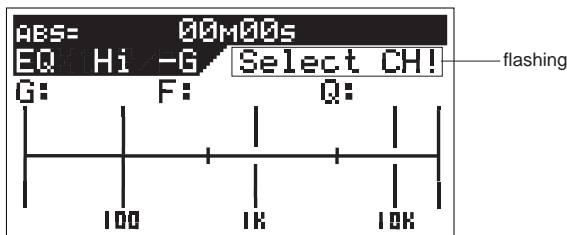

CH STATUS/CH SEL indicators for the compressor channels do not flash.

2. Press the [CH STATUS/CH SEL] key of the desired channel. The current settings are shown, together with the selected channel name. The gain value flashes, indicating that you can edit it.

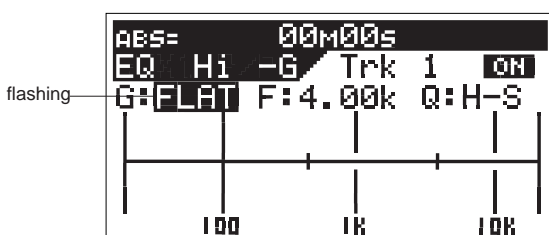

3. Use the [HI-G/F/H] (or [MID-G/F/Q] or [LO-G]) or [HOLD/ >] key to select a parameter. Each time you press the key, the flashing parameter (to be edited) changes in the following order. G -> F -> Q -> ON -> G (When setting the LO equalizer, the flashing parameter changes between G and ON.)
4. Use the [JOG] dial to select the desired value. The following shows an example for editing the HI EQ's gain. The curve corresponding to the setting value is graphically shown. Setting this directly affects the sound.

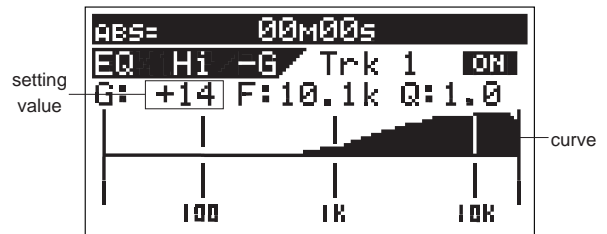

By rotating the [JOG] dial, you can set each parameter to the desired value within the range shown below.

•Controllable channels:

Channels 1 through 16 and the master channel. You cannot equalize channels 13-14 or 15-16 if they are set as the compressor channels via the Setup mode.

•Available parameters and setting ranges:

(HI-G/F/H)

G (gain): -18 dB to FLAT to +18 dB (default: FLAT)
 F (frequency): 500 Hz to 20.2 kHz (default: 4.00 kHz)
 Q: LPF, H-S, 0.1 to 20 (default: H-S)
 ON/OFF: ON or OFF (default: ON)

(MID-G/F/H)

G (gain): -18 dB to FLAT to +18 dB (default: FLAT)
 F (frequency): 500 Hz to 20.2 kHz (default: 1.00 kHz)
 Q: LPF, H-S, 0.1 to 20 (default: 1.0)
 ON/OFF: ON or OFF (default: ON)

(LO-G)

G (gain): -18 dB to FLAT to +18 dB (default: FLAT)
 F (frequency): fixed to 400 Hz (effective frequency: 100 Hz)
 Q: fixed to L-S
 ON/OFF: ON or OFF (default: ON)

*LPF: low pass filter

*H-S: hi-shelving

*L-S: low-shelving

4. To edit the EQ for another channel, repeat step 1 through 3.
5. After completing EQ editing, press the [EXIT/NO] key. The VF-16 exits the EQ edit mode and the display returns to the Normal display.

Controlling Effect send level

You can control send levels of channels 1 through 16 (pre- or post-fader) to the two internal A.S.P. effect processors. The master channel controls the effect send master level.

- Press the [EFF1/EFF2] key to bring up the effect send level screen. Each time you press the [EFF1/EFF2] key, the EFF1 send level and EFF2 send level screens alternate. The first time you bring up the channel parameter edit screen, the message prompting to select a channel ("Select CH!") flashes, as well as all the CH STATUS/CH SEL indicators on the panel flash. From the second time on, the previously selected channel is selected and ready to be edited when bringing up the screen (as shown in the drawing of step 2 below).

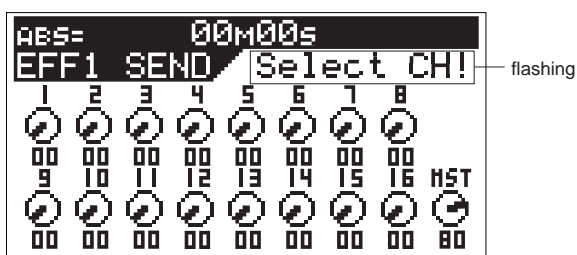

- Press the [CH STATUS/CH SEL] key of the desired channel. The current settings are shown, together with the selected channel name. The icon for the selected channel is flashing, indicating that you can edit it.

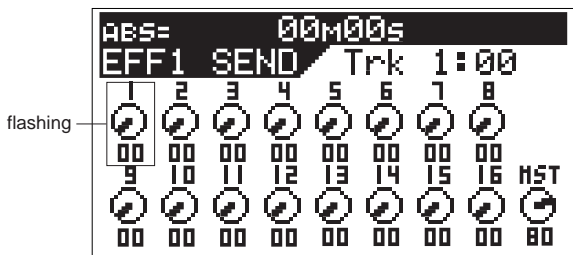

- Use the [JOG] dial to control the send level. The numeric value and the marker position of the rotary pot icon change according to the current level.

- Controllable channels:
Channels 1 through 16 and the master level.
- Available values:
00 to 99 (dB), (the default setting: channels 1 through 16: "00", master level: "80")

- To set another channel's send level, repeat steps 2 and 3 above.
- After completing send level editing, press the [EXIT/NO] key. The VF-16 exits the channel edit mode and the display returns to the Normal display.

Selecting pre/post of Effect sends

You can select whether the pre-fader or post-fader signal is sent from each channel (1 to 16) to the effect processor.

If you select "Post", the signal adjusted by the channel fader is sent to the effect processor is also lowered. If you select "Pre", the signal that is not affected by the channel fader is sent to the effect processor, so even if you lower the channel fader to minimum, the signal can be sent to the effect processor.

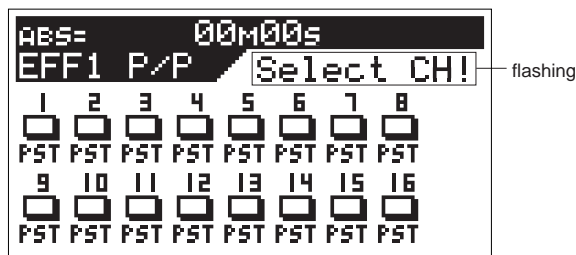

- Press the [EFF1/EFF2] key while holding down the [SHIFT] key. Each time you press the [EFF1/EFF2] key while holding down the [SHIFT] key, the pre/post selection screens for EFF1 and EFF2 alternate. The first time you bring up the channel parameter edit screen, the message prompting to select a channel ("Select CH!") flashes, as well as all the CH STATUS/CH SEL indicators on the panel flash. From the second time on, the previously selected channel is selected and ready to be edited when bringing up the screen (as shown in the drawing of step 2 below).

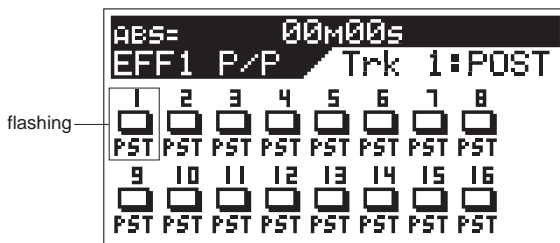

- Press the [CH STATUS/CH SEL] key of the desired channel. The current settings are shown, together with the selected channel name. The icon for the selected channel is flashing, indicating that you can edit it.



- Use the [JOG] dial to switch the selection. The icon color and label changes according to the selection, as shown below.

 PRE	The pre-fader signal is sent to the effect processor.
 PST	The post-fader signal is sent to the effect processor.
<ul style="list-style-type: none"> •Controllable channels: Channels 1 through 16. •Available options: PRE or PST (post), (default: all channels: "PST") 	

- To set another channel's pre/post selection, repeat steps 2 and 3 above.
- After completing the pre/post selection, press the [EXIT/NO] key.
The VF-16 exits the channel edit mode and the display returns to the Normal display.

Controlling AUX SEND level

You can control send levels of channels 1 through 16 (pre- or post-fader) from the AUX SEND jack on the rear panel. The master channel controls the AUX send master level.

- Press the [AUX1/AUX2] key to bring up the AUX send level screen.
Each time you press the [AUX1/AUX2] key, the AUX1 send level and AUX2 send level screens alternate.
The first time you bring up the channel parameter edit screen, the message prompting to select a channel ("Select CH!") flashes, as well as all the CH STATUS/CH SEL indicators on the panel flash. From the second time on, the previously selected channel is selected and ready to be edited when bringing up the screen (as shown in the drawing of step 2 below).

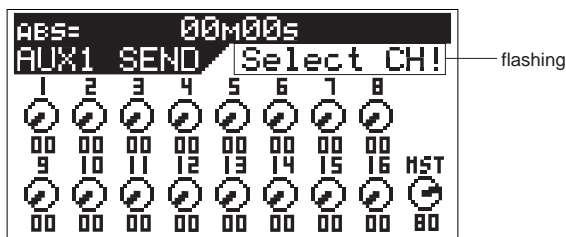

- Press the [CH STATUS/CH SEL] key of the desired channel.
The current settings are shown, together with the selected channel name. The icon for the selected channel is flashing, indicating that you can edit it.

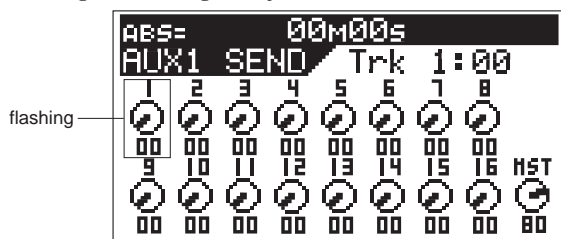

- Use the [JOG] dial to control the send level.
The numeric value and the marker position of the rotary pot icon change according to the current level. ("80", the default value, is the reference level.)

- Controllable channels:
Channels 1 through 16 and the master level.
- Available values:
00 to 99 (dB), (the default setting: channels 1 through 16: "00", master level: "80")

- To set another channel's send level, repeat steps 2 and 3 above.
- After completing send level editing, press the [EXIT/NO] key.
The VF-16 exits the channel edit mode and the display returns to the Normal display.

Selecting pre/post of AUX sends

You can select whether the pre-fader or post-fader signal is fed from each channel (1 to 16) to the AUX SEND jack. If you select "Post", the signal adjusted by the channel fader is sent to the effect processor, so if you lower the channel fader, the signal sent to the effect processor is also lowered.

If you select "Pre", the signal that is not affected by the channel fader is sent to the effect processor, so even if you lower the channel fader to minimum, the signal can be sent to the effect processor.

- Press the [AUX1/AUX2] key while holding down the [SHIFT] key to bring up the pre/post selection screen.
Each time you press the [AUX1/AUX2] key while holding down the [SHIFT] key, the pre/post selection screens for EFF1 and EFF2 alternate. The first time you bring up the channel parameter edit screen, the message prompting to select a channel ("Select CH!") flashes, as well as all the CH STATUS/CH SEL indicators on the panel flash. From the second time on, the previously selected channel is selected and ready to be edited when bringing up the screen (as shown in the drawing of step 2 below).

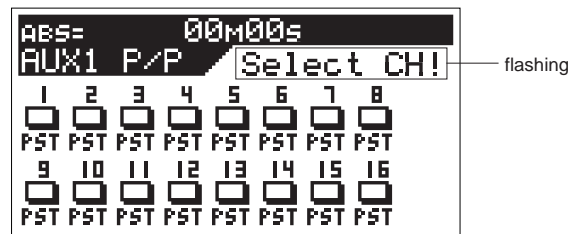

- Press the [CH STATUS/CH SEL] key of the desired channel.
The current settings are shown, together with the selected channel name. The icon for the selected channel is flashing, indicating that you can edit it.

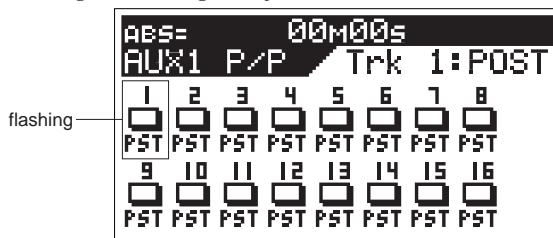

- Use the [JOG] dial to switch the selection.
The icon color and label changes according to the selection, as shown below.

	The pre-fader signal is fed to the AUX SEND jack.
	The post-fader signal is fed to the AUX SEND jack.
<ul style="list-style-type: none"> •Controllable channels: Channels 1 through 16. •Available options: PRE or PST (post) (default: all channels: "PST") 	

- To set another channel's pre/post selection, repeat steps 2 and 3 above.

- After completing the pre/post selection, press the [EXIT/NO] key.
The VF-16 exits the channel edit mode and the display returns to the Normal display.

Controlling fader levels

You can control fader levels for channels 1 through 16 and the master channel while viewing the numeric values.

- Press the [PAN] key while holding down the [SHIFT] key. The current fader positions for all channels are shown both graphically and numerically.

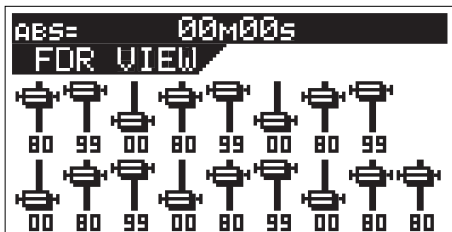

- Use the desired fader to control the channel level. The fader position shown on the screen (both graphically and numerically) changes according to the actual fader position in real-time.

- Controllable channels:
Channels 1 through 16 and the master channel
- Available values:
00 to 99 (The value is displayed by a whole number but the actual signal level is changed smoothly and continuously.)

- After completing fader level setting, press the [EXIT/NO] key. The VF-16 exits the channel edit mode and the display returns to the Normal display.

Setting the compressor

You can apply the built-in compressor only to the channels selected by "Compressor channel setting" in the Setup mode.

<Compressor function>
The compressor is used to compress the dynamic range of the input signal. If the input signal exceeds a given level (the threshold level), the gain is decreased as the input signal level increases, to reduce the dynamic range of the output signal.

<Hints>
You can apply the built-in compressor only to channels 13 through 16 and the master channel. You can select the channels to be compressed between channel 13-14 and 15-16 by using "Compressor channel setting" in the Setup mode. You can apply the compressor to the master channel anytime regardless of the compressor channel setting. See the detailed information on page 112 for the Setup mode.

<Note>
You cannot apply the equalizer to the input channels that the compressor is applied to. However, you can apply both the equalizer and compressor to the master channel.

The following operations are assumed that the compressor is applied to channels 13 and 14.

- Press the [HI-G/F/Q] key while holding down the [SHIFT] key.
The compressor setting screen appears. The message prompting to select a channel ("Select CH!") flashes, as well as the CH STATUS/CH SEL indicators for the master channel and input channels (13-14 or 15-16) to which the compressor is applied flash.

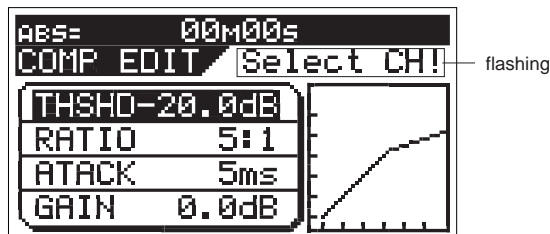

- Press the [CH STATUS/CH SEL] key of the desired channel. You can now edit parameters of the compressor for the channel.

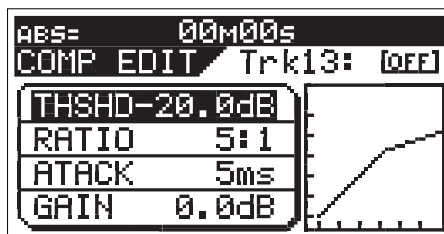

- Press the [HI-G/F/Q] key while holding down the [SHIFT] key to select the desired parameter, and enter the desired value using the [JOG] dial. Each time you press the [HI-G/F/Q] key while holding down the [SHIFT] key, the parameters to be edited are cycled between "THSHD" (threshold level), "RATIO", "ATTACK" (attack time), "GAIN" and "ON/OFF" (compressor on/off). For each parameter, rotating the [JOG] dial can set the following values.

- Channels to be selected
Channels 13-14, 15-16 and the master channel
- Available values
Threshold level: 0.0 dB to -50.0 dB (in 0.5 dB increments)
(The default setting: 13-14/15-16->-20dB, master->-25dB)
Ratio: ∞ :1, 20:1, 10:1, 8:1, 6:1, 5:1, 4:1, 3.5:1, 3:1, 2.5:1, 2:1, 1.7:1, 1.5:1, 1.3:1, 1.1:1, 1:1
(The default settings: 13-14/15-16 -> 10:1, master -> 4:1)
Attack time: 5 ms to 75 ms (in 1 ms increments)
(The default settings: 13-14/15-16 -> "60ms", master -> "8ms")
Gain: 0.0 dB to +18.0 dB (in 0.5 dB increments)
(The default settings: 13-14/15-16/master -> 0.0 dB.)
Compressor on/off: On, Off (The default is "Off.")

- After completing the parameter setting, press the [EXIT/NO] key. The VF-16 exits the channel edit mode and the display returns to the Normal display.

<Hints>

If you try to select a channel to which the compressor cannot be applied, a warning message ("Can't select!") will flash and the operation will be cancelled. The following screen shows that you can apply the compressor to channels 13-14 and the master channel.

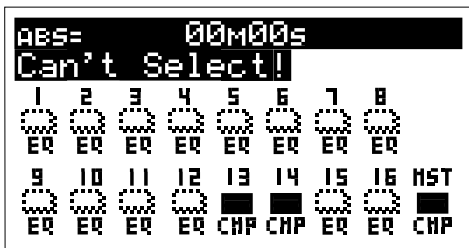

Channel view

You can see the current setting information for channels 1 through 16 via the Channel view screen.

- 1) Channel on/off
- 2) Fader levels
- 3) Send levels and pre/post selections for EFF1, EFF2, AUX1 and AUX2.
- 4) Pan positions
- 5) Signal destination (stereo busses or Rec busses)

1. Press the [LO-G] key while holding down the [SHIFT] key. The channel view screen appears. The first time you bring up the channel parameter edit screen, the message prompting to select a channel ("Select CH!") flashes, as well as all the CH STATUS/CH SEL indicators on the panel flash. From the second time on, the screen shows the status information of the previously selected channel when bringing up the screen (as shown in the drawing of step 2 below).

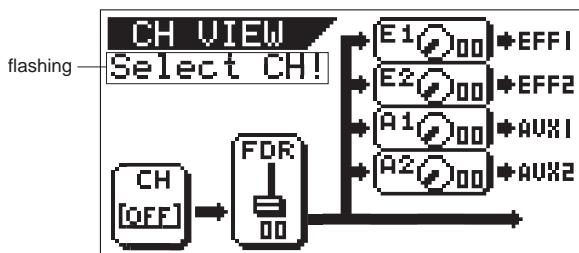

2. Press the [CH STATUS/CH SEL] key of the desired channel. The current setting information is shown, together with the channel name.

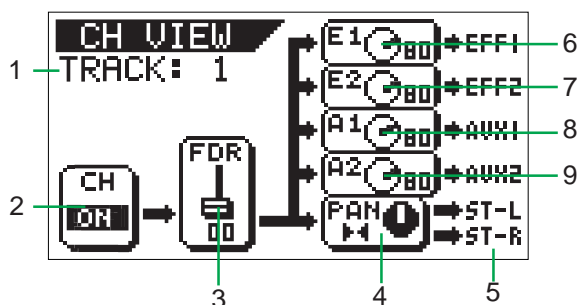

The screen example above shows the following status.

1	Channel 1 is currently selected.
2	The channel is on.
3	The channel fader is set to "00" (-∞).
4	The pan is in the center position.
5	The signal is fed to ST OUT (L/R).
6 9	The post-fader signal of the selected channel is fed to EFF1, EFF2, AUX1 and AUX2 at level 80.

3. To turn off the channel view screen, press the [EXIT/NO] key. The VF-16 exits the channel edit mode and the display returns to the Normal display.

Effect Edit Mode

The VF-16 offers high quality ambient effects by employing the A. S. P. (Fostex Advanced Signal Processing Technology), which is exclusively developed by Fostex. With the A. S. P., you can obtain an incomparably clean and high density Hall Reverb, overwhelmingly clear Room Reverb and wonderfully hi-fidelity Plate Reverb. In addition to these typical Reverbs, the VF-16 provides not only various practical algorithms such as Delay, Chorus, Flanger and Pitch Bend, but some combinations of these are also available, e.g., Delay+Reverb.

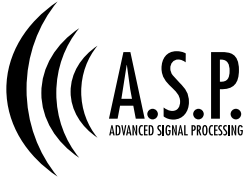

* A. S. P. (Fostex Advanced Signal Processing Technology)

The A. S. P. is an exclusive new digital effect processing technology designed by Fostex. This method extracts maximum efficiency from the limited DSP power. It achieves an overwhelmingly high density Early Reflection sound and wonderfully smooth High Dump response through the H. F. A. (Harmonic Feedback Algorithm). Also, it carries out an elaborate reverb simulation with clear sounds through the H. D. L. P. (Hi-Density Logarithmic Processing), which eliminates the mutual interference between the numerous integrated delay modules and reduce the impurity and girt of the sound.

* H. F. A. (Harmonic Feedback Algorithm)

There is one of indispensable elements in the natural echo called "Early Reflection Sound," which is usually sacrificed in commercial reverb products in order to reduce costs. (In practice, the Early Reflection Sound means the very first reverberated sound that bounces back from walls, floors and ceilings of concert halls). The entire reverb sound quality depends on this Early Reflection Sound and how closely it can resemble the real echo. The H. F. A. is an algorithm that enables the effect unit to reproduce a clear and natural Early Reflection Sound by applying an ideal harmonic feedback to each delay module.

* H. D. L. P. (Hi-Density Logarithmic Processing)

The reverb sounds consist of lots of small delay elements combined in a complex way, which are produced by many delay modules inside the effect unit. In order to obtain smooth and comfortable reverb sounds, it is very important to efficiently organize the relationship between each delay module and minimize negative mutual interference. The H. D. L. P. is a technology which applies efficient logarithmic processing to each delay module, so that they can work in the most efficient way in order to eliminate harmful reverb elements and roughness. This makes it possible to establish high density and transparent sounds.

Before the operation, we will briefly discuss the effect functions here such as Reverb, Delay, Chorus, and Flanger, which are integrated in the VF-16.

Reverb

The so called Reverb effect consists of various reflection sounds mixed together. For example, when you clap your hands in a tunnel, you will hear the sound linger even after you stop clapping your hands. This is the Reverb.

The sounds we normally hear in daily life have three types of sounds mixed together, i.e., "Direct sound," "Early Reflection sound" and "Late Reflection sound." The Direct sound means the sound directly reaches the ears from the sound source. The Early Reflection sound means the sound that comes after the Direct sound and has rebound off the wall of the tunnel up to a few times. The Late Reflection sound means that the sound rebounds many times long after the Direct sound has disappeared. Our ears normally hear the "Direct sound" - "Early Reflection sound" - "Late Reflection sound" in the order.

Delay

This is the effect to added a delayed sound to the original sound. You can obtain a richer sound or completely change the original source sound by using the Delay.

Chorus

This makes the one original sound appear to have many sources. The Chorus is used to widen or thicken the original sound.

Flanger

The Flanger is one of applications of the Delay. This is used to create a sound like a jet airplane ascending or descending.

About the effect types

The VF-16 contains two independent DSP multi-effect units; EFF 1 and EFF 2.

A variety of effect types are preset for each effect unit. By selecting a suitable effect type, you can process the sound as you wish. You can also edit the parameters of the selected effect type to create your own effect sounds.

The following 28 effect types are preset for EFF 1. The 38 effect types shown on the next page are provided for EFF 2, and these include the same 28 effect types as EFF 1.

Effect types preset for EFF 1

	Name	Parameter type	Explanation
L01	Norm HALL	REVERB	Standard hall reverb; detailed and transparent, with a moderate amount of early reflections.
L02	Pres HALL	REVERB	Hall reverb with presence and definition.
L03	Wet HALL	REVERB	Hall reverb with restrained high-frequency and a refreshing atmosphere.
L04	NoER HALL	REVERB	All-purpose hall reverb with no early reflections, and even decay of all frequencies.
L05	Lo-F HALL	REVERB	Hall reverb with lingering low-frequency reverberation.
L06	STADIUM	REVERB	Stadium reverb characterized by long early reflections.
L07	AUDITORIUM	REVERB	Reverb simulating an auditorium with suppressed reverberation.
L08	HALL WAY	REVERB	Reverb with a long pre-delay, creating the impression of an extended space.
L09	Norm ROOM	REVERB	Room reverb simulating a moderate space with some sparkle.
L10	Dead ROOM	REVERB	Room reverb simulating a narrow and dead room. Adding a slight amount will give warmth to the sound.
L11	Pres ROOM	REVERB	All-purpose room reverb, with good definition and few early reflections.
L12	DrumBOOTH	REVERB	Room reverb simulating a drum booth.
L13	GARAGE	REVERB	Room reverb simulating a narrow and live space like a garage, with crisp presence.
L14	NormPLATE	REVERB	Modern-sounding plate reverb with wide bandwidth.
L15	Old PLATE	REVERB	Standard plate reverb with the character of older plate units.
L16	PresPLATE	REVERB	Plate reverb with good definition and extended high-frequencies.
L17	Wet PLATE	REVERB	Plate reverb with a gentle character.
L18	DigiPLATE	REVERB	Plate reverb that emphasizes a digital character, with metallic early reflections.
L19	NormVOCAL	REVERB	All-purpose hall reverb with no early reflections, and uniform decay at all frequencies.
L20	PresVOCAL	REVERB	Short reverberation with extended high frequency is added to the early reflections of an ideal vocal booth. Since this adds sparkle to the sound, it is effective when you wish to bring the vocal to the forefront.
L21	SoloVOCAL	REVERB	Plate-like reverb is added to a spacious short delay. This blends well with any genre of music.
L22	Arena VOC	REVERB	Gentle reverb is added to spacious stadium-type early reflections.
L23	Arena CHO	REVERB	Short reverb with extended high frequency is added to spacious stadium-type early reflections. Effective on chorus parts.
L24	KARAOKE	REVERB	All-purpose reverb (karaoke style) that makes any vocal sound professional.
L25	MnDL-HALL	DLY+REVERB	A combined effect of mono delay and hall reverb.
L26	MnDL-PLT	DLY+REVERB	A combined effect of mono delay and plate reverb.
L27	PnDL-HALL	DLY+REVERB	A combined effect of panning delay and hall reverb.
L28	PnDL-PLT	DLY+REVERB	A combined effect of panning delay and plate reverb.

Effect types preset for EFF 2

	Name	Parameter type	Explanation
L01 ~ L28	1-28 are the same effect types as the EFF 1 presets listed on the preceding page. (For details refer to the preceding page.)		
L29	MonoDELAY	DELAY	Mono delay
L30	PanDELAY	DELAY	Panning delay
L31	MonoBpmDL	BPM DELAY	Mono delay. Specify BPM and note value to set the delay time.
L32	PanBpmDL	BPM DELAY	Panning delay. Specify BPM and note value to set the delay time.
L33	Short DL	SHORT DELAY	Short delay that allows you to set the delay time precisely.
L34	DOUBLING	DOUBLING	Doubling that allows you to set separate delay times for L and R.
L35	CHORUS	CHORUS	Produces a chorus effect. A doubling effect can also be added.
L36	FLANGE	FLANGE	Produces a flanging effect.
L37	MonoPITCH	MONO PITCH	Pitch shift adjustable in a +/-2 octave range.
L38	DlyPITCH	DELAY PITCH	Pitch shift with a feedback delay, allowing strange effects to be produced.

Selecting the effect type

Here's how to select the effect type for EFF 1 or EFF 2.

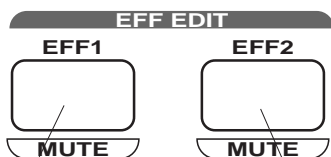

Press this to set the effect type for EFF 1.

Press this to set the effect type for EFF 2.

- * As described earlier in "Basic Recording and Playback," raise the CHANNEL fader of a channel to which a signal is being input and raise the MASTER fader, so that the sound is heard at an appropriate level.
- * As described earlier in "Setting the effect send level," raise the EFF 1 SEND level or the EFF 2 SEND level for the channel(s) to which you wish to apply the effect.

1. If you wish to set EFF 1, press the EFF EDIT mode [EFF 1] key. To set EFF 2, press the [EFF 2] key. With the initial settings, the following displays will appear.

When the [EFF 1] key is pressed:
With the initial settings, [L01: Norm HALL] will appear.

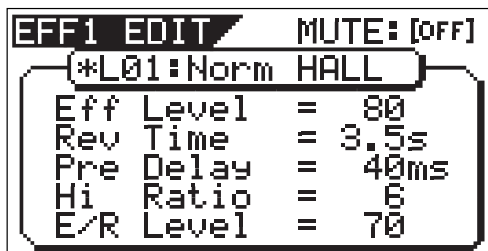

When the [EFF 2] key is pressed:
With the initial settings, [L35: CHORUS] will appear.

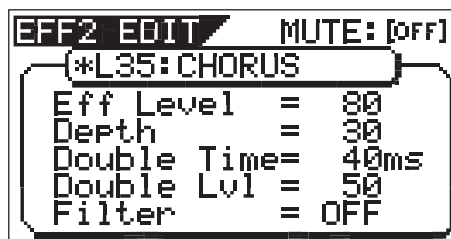

2. Use the [JOG] dial to select the effect type. The effect types listed in the foregoing tables will appear in succession. When an effect type appears, it will be blinking. The blinking indicates that the effect type has not yet been selected.
3. Press the [ENTER/YES] key. The effect type will be finalized, and the parameter setting screen will appear. The default (initial) parameter values will be displayed.

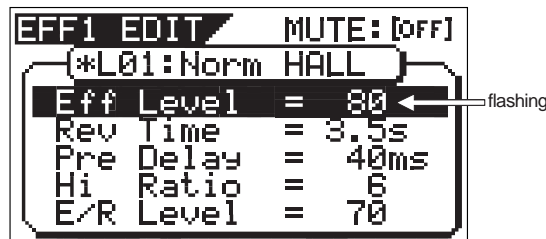

Details on the parameters are given in the following section, "Parameter settings."

4. To exit Effect Edit mode, press the [EXIT/NO] key twice in succession. You will return to Normal display.

< Note >
When you press the [ENTER/YES] key to finalize the effect type, the sound will be muted for an instant.

Effect parameter settings

Here's how to set the effect parameters.

1. If the effect parameter that you wish to adjust is not displayed, press the [EFF 1] key (or the [EFF 2] key) twice.
One of the parameters of that effect type will appear.

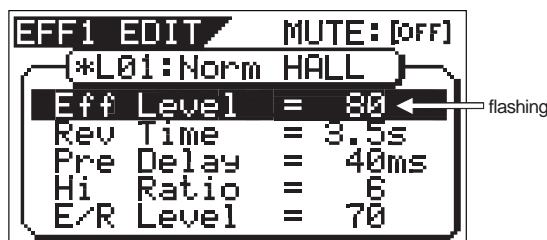

2. Press the [EFF 1] key (or the [EFF 2] key) several times to display the desired parameter.
The parameters that appear will differ, depending on the effect type that is selected.

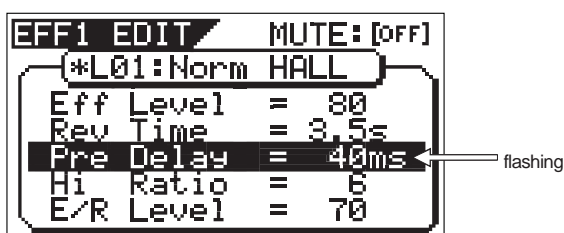

3. Use the [JOG] dial to adjust the value.
For details on the meaning and range of each parameter, refer to "Effect parameter details" on the next page.

4. If you wish to adjust another parameter, repeat from <step 2>.
5. When you are finished making settings, press the [EXIT/NO] key twice to exit Effect Edit mode.

Muting an effect

You can mute the effect sound of effect 1 or effect 2.

* To mute the effect sound:

Hold down the [SHIFT] key and press the [EFF 1] key (or [EFF 2] key).

The effect sound of effect 1 (or effect 2) will be muted, and the dry sound will be heard.

When muting is on, the [EFF 1] key (or [EFF 2] key) LED is off.

* To cancel muting:

Once again hold down the [SHIFT] key and press the [EFF 1] key (or [EFF 2] key).

The dry sound will change back to the effect sound.

When mute is turned off, the [EFF 1] key (or [EFF 2] key) LED is off.

Effect parameter details

The parameters that can be adjusted will depend on the parameter type.

Reverb effect parameters (parameter type: REVERB)

For effect types 1-24 of the preceding "Effect type" table, the following four parameters can be adjusted.

- | | |
|--------------|---|
| 1. Eff Level | Adjust the effect return level: 0-99 |
| 2. Rev Time | Adjust the length of reverberation. Range: 0.1-9.9 seconds |
| 3. Pre Delay | Adjust the time from the original sound until reverberation begins. Range: 0-100 ms |
| 4. Hi Ratio | Adjust the decay ratio of the high frequencies. Range: 0-10 |
| 5. E/R Level | Adjust the volume of the early reflections. Range: 0-99 |

Delay+reverb effect parameters (parameter type: DELAY+REVERB)

For effect types 25-28 of the preceding "Effect type" table, the following four parameters can be adjusted.

- | | |
|---------------|--|
| 1. Eff Level | Adjust the effect return level: 0-99 |
| 2. Delay Time | Adjust the delay time: Range: 1-230 ms |
| 3. Feedback | Adjust the number of delay repeats. Range: 0-99 |
| 4. Delay Bal | Adjust the delay balance. Range: 0-99 |
| 5. Rev Time | Adjust the length of reverberation. Range: 0.1-9.9 seconds |

Delay effect parameters (parameter type: DELAY)

For effect types 29 and 30 of the preceding "Effect type" table, the following four parameters can be adjusted.

- | | |
|---------------|--|
| 1. Eff Level | Adjust the effect return level: 0-99 |
| 2. Delay Time | Adjust the delay time. Range: 1-680 ms |
| 3. Feedback | Adjust the number of delay repeats. Range: 0-99 |
| 4. Hi Ratio | Adjust the decay ratio of the high frequencies. Range: 0-10 |
| 5. Filter | Adjust the tone of the delay sound. Range: L9-L1, OFF, H1-H9 |
- * L1-L9 = LPF (larger numbers will lower the cutoff frequency)
* H1-H9 = HPF (larger numbers will raise the cutoff frequency)

BPM delay effect parameters (parameter type: BPM DELAY)

For effect types 31 and 32 of the preceding "Effect type" table, the following four parameters can be adjusted.

- 1. Eff Level Adjust the effect return level: 0-99
- 2. BPM Adjust the BPM. Range: 30-250 bpm
- 3. Note Select the note value for the delay. Range: 24, 16, 8T, 16...8, 4T, 8., 4, 2T, 4., 2, 2., 1
 - * 24 = 16th note sextuplets, 16 = 16th notes, 8T = 8th note triplets, 16. = dotted sixteenth notes, 8 = 8th notes, 4T = quarter note triplets, 8. = dotted eighth notes, 4 = quarter notes, 2T = half-note triplets, 4. = dotted quarter notes, 2 = half notes
 - * The "." shown in the ninth character of the LCD indicates a dotted note.
 - * The "T" shown in the ninth character of the LCD indicates a triplet.
- 4. Feedback Adjust the number of delay repeats. Range: 0-99 (100 steps in increments of 1)
- 5. Filter Adjust the tone of the delay sound. Range: L9-L1, OFF, H1-H9
 - * L1-L9 = LPF (larger numbers will lower the cutoff frequency)
 - * H1-H9 = HPF (larger numbers will raise the cutoff frequency)

Short delay effect parameters (parameter type: SHORT DELAY)

For effect type 33 of the preceding "Effect type" table, the following four parameters can be adjusted.

- 1. Eff Level Adjust the effect return level: 0-99
- 2. Delay Time Adjust the delay time. Range: 0.1-9.9 ms, 10-99 ms, 100-200 ms
- 3. Feedback Adjust the number of delay repeats. Range: 0-99
- 4. Hi Ratio Adjust the decay ratio of the high frequencies. Range: 0-10
- 5. Filter Adjust the tone of the delay sound. Range: L9-L1, OFF, H1-H9
 - * L1-L9 = LPF (larger numbers will lower the cutoff frequency)
 - * H1-H9 = HPF (larger numbers will raise the cutoff frequency)

Doubling effect parameters (parameter type: DOUBLING)

For effect type 34 of the preceding "Effect type" table, the following three parameters can be adjusted.

- 1. Eff Level Adjust the effect return level: 0-99
- 2. Lch Delay Adjust the delay time of the L channel. Range: 0.1-9.9 ms, 10-99 ms, 100-200 ms
- 3. Rch Delay Adjust the delay time of the R channel. Range: 0.1-9.9 ms, 10-99ms, 100-200 ms
- 4. Filter Adjust the tone of the delay sound. Range: L9-L1, OFF, H1-H9
 - * L1-L9 = LPF (larger numbers will lower the cutoff frequency)
 - * H1-H9 = HPF (larger numbers will raise the cutoff frequency)

Chorus effect parameters (parameter type: CHORUS)

For effect type 35 of the preceding "Effect type" table, the following four parameters can be adjusted.

- 1. Eff Level Adjust the effect return level: 0-99
- 2. Depth Adjust the chorus depth. Range: 0-99
- 3. Double Time Adjust the time difference of the doubling effect. Range: 0-99
- 4. Double Lvl Adjust the volume of the doubling effect. Range: 0-99
- 5. Filter Adjust the tone of the delay sound. Range: L9-L1, OFF, H1-H9
 - * L1-L9 = LPF (larger numbers will lower the cutoff frequency)
 - * H1-H9 = HPF (larger numbers will raise the cutoff frequency)

Flanger effect parameters (parameter type: FLANGE)

For effect type 36 of the preceding "Effect type" table, the following four parameters can be adjusted.

- 1. Eff Level Adjust the effect return level: 0-99
- 2. Rate Adjust the speed of modulation. Range: 0.01-2.00 Hz
- 3. Depth Adjust the depth of modulation. Range: 0-99
- 4. Mod Delay Adjust the modulation delay. Range: 0-200
- 5. Feedback Adjust the number of modulation repeats. Range: 0-99

Mono pitch effect parameters (parameter type: MONO PITCH)

For effect type 37 of the preceding "Effect type" table, the following three parameters can be adjusted.

- 1. Eff Level Adjust the effect return level: 0-99
- 2. Pitch Adjust the amount of pitch shift. Range: -24-0-+24
 - * +/-12 is one octave. +/-24 is two octaves.
- 3. Adjust Make fine adjustments to the amount of pitch shift. Range: -50-0-+50
 - * +50 is a semitone sharp. -50 is a semitone flat.
- 4. Mode Select the processing method. Range: 1-3

Delay pitch effect parameters (parameter type: DELAY PITCH)

For effect type 38 of the preceding "Effect type" table, the following four parameters can be adjusted.

- 1. Eff Level Adjust the effect return level: 0-99
- 2. Pitct Adjust the amount of pitch shift. Range: -24-0-+24
 - * +/-12 is one octave. +/-24 is two octaves.
- 3. Adjust Make fine adjustments to the amount of pitch shift. Range: -50-0-+50
 - * +50 is a semitone sharp. -50 is a semitone flat.
- 4. Delay Time Adjust the delay time until the pitch-shifted sound is heard. Range: 0-500 ms
- 5. Feedback Adjust the number of delay repeats. Range: 0-99

Scene memory

The VF-16 provides 100 scene memories (Scene numbers 00 to 99). You can store a set of desired parameter settings to each memory. Items to be stored include all parameters set by the channel parameter edit and effect edit modes, as well as all channel fader levels. Furthermore, you can give a desired scene name with up to 16 alphanumeric or symbolic characters to each scene memory (Note that up to 14 characters can be shown on the display). In addition to 100 scene memories, the VF-16 also provides 10 temporary memories (Temporary numbers 00 to 09). Note that all the setting stored in a temporary memory disappears when turning off the power.

Storing to a scene memory

You can store the current settings to a scene memory by the following procedure.

1. Press the [SCENE-STORE] key.
The display shows the screen for selecting the scene number.

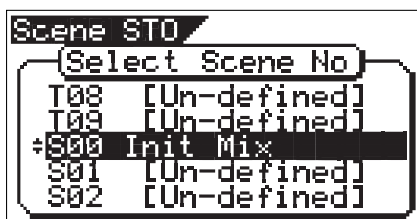

2. Use the [JOG] dial to select the desired scene number to which you want to store the current settings, and press the [ENTER/YES] key.

The display shows the screen for editing a title of the selected scene number. The name of the program which you worked before entering the scene memory mode is duplicated to the name of the selected scene number, whose first character flashes, showing that it can be edited.

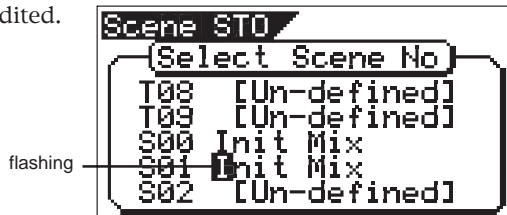

3. Enter the desired scene name using the JOG dial for selecting a character and using the [REWIND]/[F FWD] keys for moving the editing (flashing) point.

You can specify a scene name with up to 16 alphanumeric or symbolic characters and can see up to 14 characters on the display. The following characters can be entered:

A to Z, a to z, 0 to 9,
+ - * / # & ! ? () [] < > : . _ , < - >

4. After completing the scene name entry, press the [ENTER/YES] key.
The display will change to the Normal display of the program whose scene name has been set.

<Hint>

Scene memories stored in the scene numbers (00 to 99) are preserved even if the power is turned off. However, a temporary memory stored in the Temporary numbers disappear and all the parameters return to the default "Un-defined" settings when the power is turned off, though they do not disappear when changing the program. If you want to store the temporary memory to a scene number (00 to 99), recall the temporary number before turning off the power and store the memory to the desired Scene number (00 to 99).

Recalling a scene memory

You can recall the settings stored in scene memories.

1. Press the [SCENE-RECALL] key.
The display shows the screen for selecting the scene number.

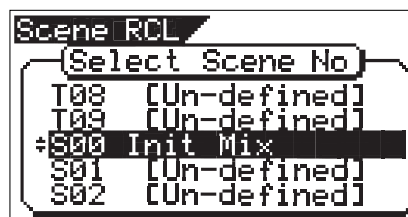

2. Use the [JOG] dial to select the desired scene number to be recalled, and press the [ENTER/YES] key.
After "Scene Recalled" appears on the display, the selected scene is recalled and the display changes to the Normal display.

<Hints>

- The contents recalled differ depending on the settings in the "Fader recall" menu in the SETUP mode. See "Settings for fader recall" menu in the SETUP mode for the detailed information.
- Regardless of the current physical positions of channel and master faders, the audio is output at the fader positions when they were stored. We suggest you to turn the audio volume down when recalling a scene memory to prevent accidentally accessing high-volume sound.
- When a scene is recalled, the red indicator of the [FADER ADJUST] key may flash, showing that the recalled fader position does not match the current physical fader position.
In such a case, you can turn off the indicator by adjusting the physical fader to the recalled fader position (Fader adjust) or by matching the audio level with the current fader position (Level adjust). See the following for the detailed information for the "Fader adjust" and "Level adjust".

Level adjust

When recalling a scene memory, if the recalled fader level does not match the current physical fader position (the red indicator of the [FADER ADJUST] key flashes), you can adjust the level to match the current fader position.

1. Press the [FADER ADJUST] key while holding down the [SHIFT] key.

The unit enters the Level adjust mode.

The fader icons appear on the display, as well as flashing "Sure?". The recalled fader positions are shown as fader knob positions while the current fader positions are indicated by > and <. In the following example, all recalled fader positions are at the lowest positions.

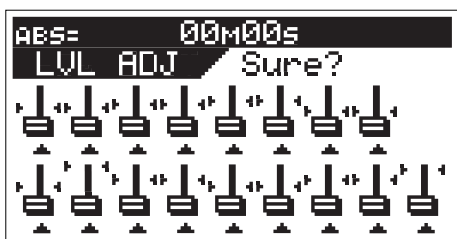

2. Press the [ENTER/YES] key.

The display shows "Completed!", immediately followed by the Normal display after each actual (internal) fader position is set to match the corresponding physical fader position. The flashing indicators of the FADER ADJUST turns off. With the example above, all actual faders are set to minimum.

Fader adjust

When recalling a scene memory, if the recalled fader level does not match the current physical fader position (the red indicator of the [FADER ADJUST] key flashes), you can move the physical faders to match the current fader positions of the scene.

The following description is assumed that "Fader recall setting" of the SETUP mode is set to "CH&MST".

1. Press the [FADER ADJUST] key alone.

The unit enters the Fader adjust mode.

The fader icons appear on the display, as well as flashing "Select CH!".

The recalled fader positions are shown as fader knob positions while the current fader positions are indicated by > and <.



2. Select the channel to be adjusted by pressing the corresponding [CH STATUS/CH SEL] key, and move the corresponding physical fader.

In the screen example below, the physical fader position of channel 1 matches the recalled fader position.



The fader icons below are examples of indicating different status.

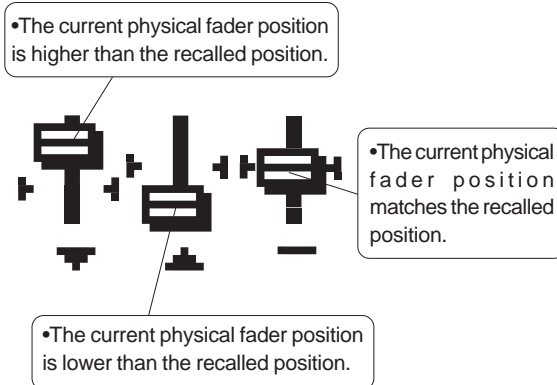

3. Repeat the previous step for each channel.
4. After adjusting all the fader positions, press the [EXIT/NO] key. The indicator of the [FADER ADJUST] key turns off.

<Note>
 The previous description for "Fader adjust" is assumed that "Fader recall setting" of the SETUP mode is set to "CH&MST". However, the default of "Fader recall setting" is "Off".
 In this setting, the indicator of the [FADER ADJUST] key will not flash when recalling a scene memory, because the fader positions are not recalled and the current fader positions remain effective.
 Therefore, if you want to make the recalled fader positions of a scene memory effective, set the "Fader recall setting" properly according to your requirement. See "SETUP mode" on page 111 for details about the fader recall setting.

<Hint>
 If the fader recall setting of the SETUP mode is set to "CH", the display shows the screen as below when the unit enters the fader adjust mode, indicating all the channel fader positions are recalled, while the master fader position is not recalled.
 Moving the master fader in this mode directly affects the actual fader level.

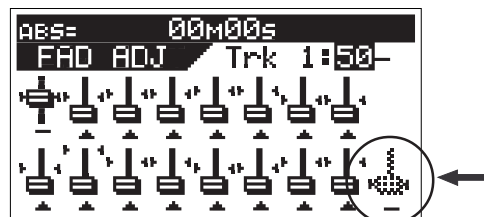

Direct recall of a scene memory

Besides recalling a scene memory by selecting the desired scene from the list as described above, you can recall a scene directly.

<Note>

You can directly recall only the scene memories following to the current scene.

For example, if the current scene number is 05, while scene memories are stored in scene numbers 01 through 10, you can directly recall scene numbers 06 through 10. Also note that scene number 00 cannot be recalled.

1. Press the [SCENE-RECALL] key while holding down the [SHIFT] key.

Each time you press the [SCENE RECALL] key while holding down the [SHIFT] key, the next scene is recalled.

If no scene memory is stored in any scene numbers except 00, when pressing the [SCENE RECALL] key while holding down the [SHIFT] key, the display shows "No-Additional Scene" and the operation is ignored. When a scene is directly recalled, the "Fader recall setting" of the SETUP mode is also effective, as described in "Recalling a scene memory" above.

Clearing a scene memory

You can clear an unnecessary scene memory by using the following procedure.

<Note>

You cannot clear the memories in scene number 00. If you select scene number 00 and try to clear the memory, "Warning Can't Clear Current Scene" appears on the display and the operation is ignored.

1. Press the [SCENE RECALL] and [SCENE STORE] keys simultaneously.

The display shows the screen for selecting a scene to be cleared. "*****" shows a user-defined scene name.

In the next step, you can select any scene number except "S00 Init Mix".

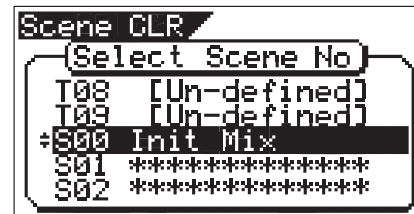

2. Select the desired scene to be cleared using the [JOG] dial, and press the [ENTER/YES] key.

The selected scene memory is cleared and the scene name changes to "[Un-defined]", showing that no memory is stored.

Scene Event Map

By creating a scene event map, you can recall desired scene memories (mixer settings) at desired positions during playback. For example, you can recall scene memory 02 at 00H 01M 34S 00F and scene memory 04 at 00H 02M 20S 20F, etc. In the following description, we assume that the time base is set to ABS. However, you may set the time base to Bar/Beat/Clk which allows you to specify the event position by Bar/Beat/Clk numbers.

<Note>

You must store data to scene memories used in a scene event map in advance. See "Scene memory" above about how to store the current settings to a scene memory.

Creating an event memory

An event memory can be created via two methods.

1. on the fly
2. by specifying a desired time

You can create up to 99 event memories (01 to 99).

Creating an event memory on the fly

1. At the desired position while the VF-16 is stopped or during playback, press the [HOLD/>] key. The time when pressing the [HOLD/>] key is held.

```
LOCATE= 00H01M59s24F99sf
HOLD
```

2. Press the [STORE] key.

```
LOCATE= 00H01M59s24F99sf
Hit Any Memory Keys!
```

3. Press the [LOCATE/EVT MEM] key while holding down the [SHIFT] key.

"Entry EVT**" (where ** shows the event memory number) appears for a short time, while the time held in step 1 is entered in the event memory.

4. To create other event memories, repeat step 1 through 3 above.

<Note>

An event memory created by the above procedure only contains event time data. To set the desired scene number to be recalled to each event memory, see "Creating the scene event map" described later.

<Hint>

Event memory numbers are assigned in ascending order of ABS time, regardless of order in which event memories are created. For example, if you first create an event memory 1 (EVT01) with data "05m 00s" and then create an event memory with data "03m 30s", the event memory 1 data is replaced with "03m 30s" automatically, while the previous data ("05m 00s") is assigned to event memory 2.

<Viewing the event memories>

The event memories created in real-time by the procedure described above can be viewed by the operation below.

1. While the VF-16 is stopped, press the [SCENE STORE/MAP] key while holding down the [SHIFT] key. The screen shows the event memory list as below, in which you can view and check the event memories created in real-time.

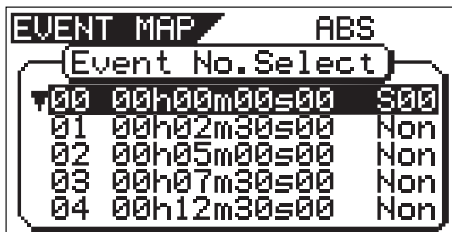

Creating an event memory by specifying the desired time

<Notes>

- The following procedure is assumed that no event memory has been created.
- Event memory 00 cannot be edited.

1. While the VF-16 is stopped, press the [SCENE STORE/MAP] key while holding down the [SHIFT] key. The display shows the screen for selecting event memory numbers. When no event memory is created, the screen shows as below.

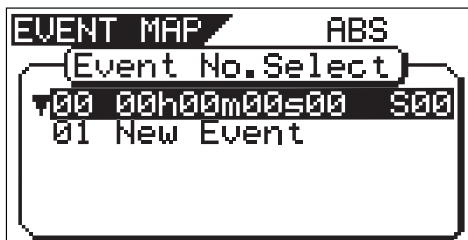

2. Select "01 New Event" using the [JOG] dial, and press the [ENTER/YES] key. Rotate the [JOG] dial to highlight "01 New Event". By pressing the [ENTER/YES] key, the event edit screen appears, where "Non" flashes in the Scene number field.

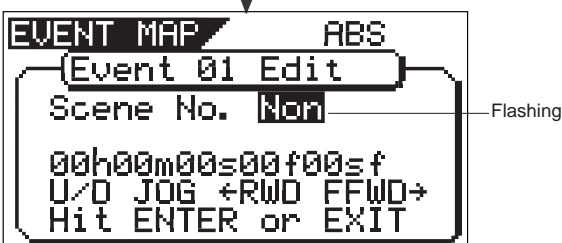

While "Non" is flashing, you can select the scene number from those currently stored by rotating the [JOG] dial. The corresponding scene names are also shown below. If no scene memory except the initial setting "S00 Init Mix" is stored, selecting any scene number (01 to 99) except 00 shows "Un-defined" on the screen.

In the description here, we skip selecting a scene number ("Non" continues to flash) and go to the next step for time editing. You may, of course, select a scene number after editing the event time.

3. Use the [F FWD] key to select the flashing (editing) field in the time display. Each time you press the [F FWD] key, the flashing (editing) field moves from h -> m -> s -> f -> sf, while each press of the [REW] key moves the flashing field in reverse order.
4. Rotate the [JOG] dial to enter the desired value for the editing field. Repeat step 3 and 4 to enter the desired values to all fields.
5. Press the [ENTER/YES] key after editing the time. The event memory with the edited time is created, and the display returns to the Normal Display.
6. To create other event memories, repeat step 1 through 5.

Creating the scene event map

After preparing the event memory list, you can create the scene event map.

Note that all necessary scene memories must be stored in advance when carrying out the following.

1. While the VF-16 is stopped, press the [SCENE STORE/MAP] key while holding down the [SHIFT] key. The screen shows the event memory list.



2. Select the desired event memory using the [JOG] dial, and press the [ENTER/YES] key. The display shows the screen for selecting the scene number for the selected event memory ("Non" flashes).
3. Select the desired scene number by using the [JOG] dial, and press the [ENTER/YES] key. The selected scene number is assigned to the event memory. In the example shown below, a scene number is assigned to each event memory.

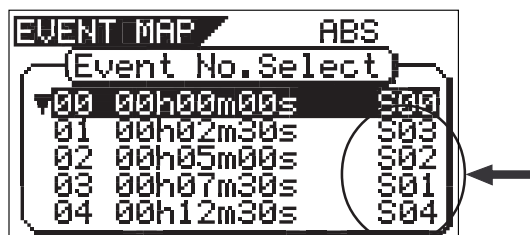

Deleting an event memory

You can delete unnecessary event memories.

<Note>

You cannot delete event memory 00.

1. While the VF-16 is stopped, press the [SCENE STORE/ MAP] key while holding down the [SHIFT] key.
The screen shows the event memory list.
2. Select the desired event memory using the [JOG] dial, and press the [ENTER/YES] key.
The display shows the screen for selecting the scene number for the selected event memory.
3. While the scene number is flashing, rotate the [JOG] dial counterclockwise.
"EVT DEL" (Event Delete) flashes in the scene number field, showing that the event memory selected above is ready to be deleted.

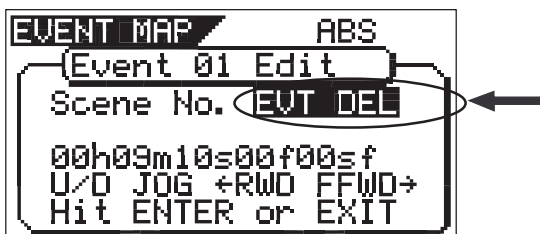

4. While "EVT DEL" is flashing, press the [ENTER/YES] key.
The selected event memory is deleted and the screen shows the event memory list.
5. Press the [EXIT/NO] key (or the [STOP] key).
The display returns to the Normal display.

Scene sequence mode on/off selection

You can turn on or off the scene sequence mode for selecting whether or not executing the scene sequence program using the scene event map.

1. While the VF-16 is stopped, press the [A RTN A PLAY/ SCENE SEQ] key while holding down the [SHIFT] key.
After "SCENE SQ: ON" is briefly shown on the screen, the Normal display appears.
Each time you press the [A RTN A PLAY/SCENE SEQ] key while holding down the [SHIFT] key, ON and OFF alternates.
When the scene sequence mode is set to ON, the scene number indicator on the Normal display is highlighted (When OFF, it is not highlighted).

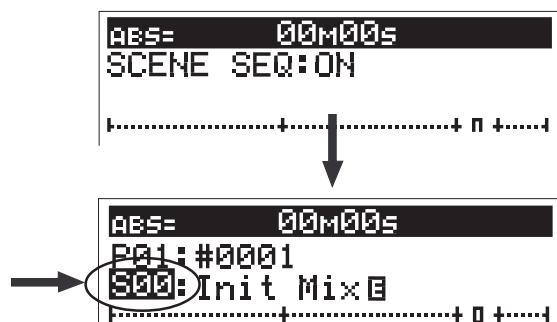

Executing the scene sequence

When the scene sequence mode is set to ON, the scenes will be recalled according to the scene event map during playback.

<Notes>

- When executing the scene sequence, the fader positions are recalled according to the fader recall mode in the SETUP mode (the default is "Off"). For example, if you set the fader recall mode to "CH & MST", both the channel and master faders are automatically recalled everytime the current scene changes. On the contrary, if you set the fader recall mode to "Off" (the default mode), fader positions are not recalled so you can manually control fader positions as you like.
We suggest you to make sure to set the fader recall mode suitably for your work before executing the scene sequence. See page 109 for details about the fader recall mode setting.
- When you do not use the scene sequence function, set the scene sequence mode to OFF.

<Screen appearances during playback>

The following show the screen appearances during playback with the scene event map in which scene number 02 (with title "XXX") is recalled at 01m 30s and scene number 05 (with title "YYY") is recalled at 05m 00s.

The unit starts playback with scene number 00 (Init Mix).

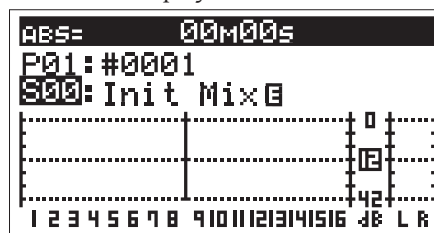

The unit recalls scene number 2 (XXX) at 01m 30s and continues playback.



The unit recalls scene number 5 (YYY) at 05m 00s and continues playback.



<Hint>

The unit continues playback with the scene number recalled by the last event memory.
Therefore, if you want to recall scene number 00 again after recalling scene number 05, you have to create the last event memory that recalls scene number 00 at the desired time.

Chapter 4 Recorder Functions

Cueing

This section describes the cueing feature for cueing sound during the F FWD or REWIND process.

Cueing with the [F FWD]/[REWIND] key

The user can cue at 3x speed by pressing the [F FWD]/[REWIND] key while the recorder is playing.

1. Start playback by pressing the [PLAY] key.
2. Press the [F FWD] or [REWIND] key during playback. Either "FWD>" or "<RWD" will appear on the LCD. Then 3x speed cueing starts in the direction chosen.
3. Press the [PLAY] key to return to the original play speed (1x speed).

Digital scrubbing with the [SCRUB] key

To enter the Digital Scrub Mode, press the [SCRUB] key while the recorder is in the STOP state to cue at 0-1x speed without any change in musical key. Digital scrub is possible for each track. The level envelope (volume wave form) of that track appears. This feature is effective when it is necessary to conduct a pinpoint search of the beginning of a song or a point (location) between songs.

1. Press the [SCRUB] key while the recorder is in the STOP state. The scrub mode is activated and the following display appears.

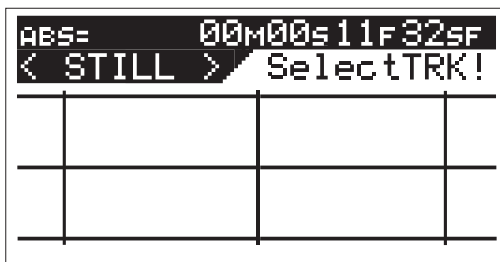

2. Press the [CH STATUS/CH SEL] key of the track to scrub. The level envelop of the track selected appears.

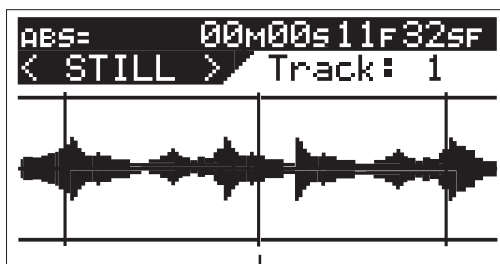

Current location

3. Turn the [JOG] dial left and right to hear the playback sound of only the track selected. The center line indicates the current location. Scrub takes place in the FORWARD or REWIND direction from this point. Either "<Scrub" or "Scrub>" appears when turning the [JOG] dial, which moves the cursor forward or reverse. The time value (or BAR/BEAT) also appears in realtime while scrubbing.
4. Press the [STOP] key to return to the normal display. The time display when ending the scrub process appears.

Shuttle Cueing

Shuttle cueing at a cue speed between 1-64x is possible by turning the [JOG] dial while the [SHIFT] key is depressed when the recorder is playing. The speed varies according to the degree the dial is turned.

1. Press the [PLAY] key to start playback.
2. Turn the [JOG/SHUTTLE] dial to the left/right while the [SHIFT] key is depressed.
 - * Turn the [JOG] dial to the right to shuttle cue in the FORWARD direction. Turn the [JOG] dial to the left to shuttle cue in the REWIND direction.
 - * The cueing speed varies from 1x, 2x, 4x, 8x, 16x, 32x and 64x according to the degree (angle) in which the [JOG] dial is turned. The current cueing speed appears on the LCD.
 - * Shuttle cueing continues as long as the [SHIFT] key is depressed, even when the [JOG] dial isn't used.
3. Lift finger from [SHIFT] key to return to the original play speed (1x).

<Remember!>
Once the data is rewound to the beginning of a program (ABS 0), playback starts from the beginning of the program, regardless of pressing the [SHIFT] key. When reaching the end of a program (ABS:23H 59M 59S), the program stops and the [PLAY] key flashes.

Variable Pitch Control

This section describes the Variable Pitch Control feature to play or record programs at variable recorder speeds. The VF-16 can change the speed in 0.1% units within a +/-6.0% range. Note that the key changes when changing the variable pitch speed.

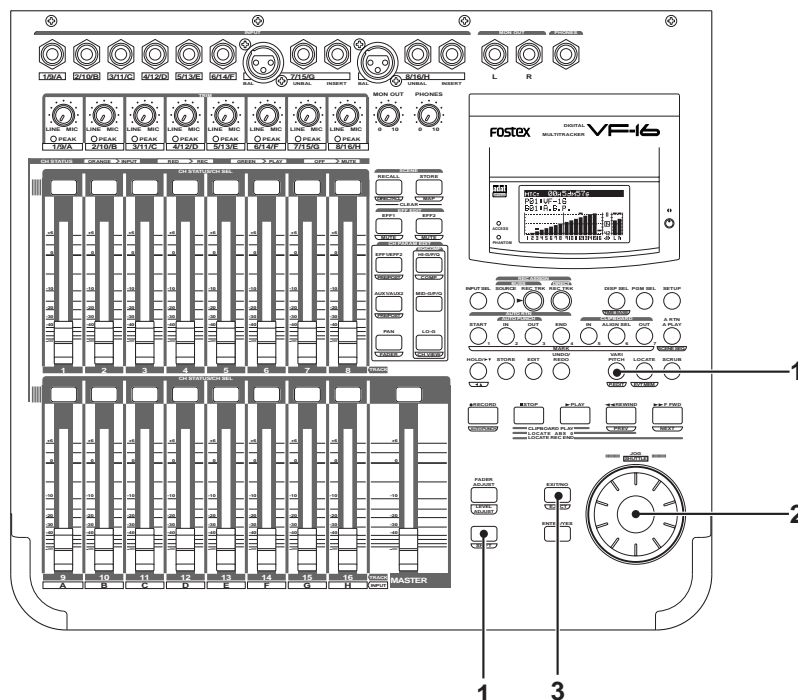

Variable Pitch Control ON/OFF

- * Press the [VARI PITCH] key.
The key lights up GREEN. This means the feature is ON.
- * Press the [VARI PITCH] key once again.
The key lights OFF. This means that the feature is OFF.

<Precaution>

The variable pitch control can be turned ON/OFF when the recorder is in the STOP/PLAY modes. Variable pitch control is not available when the recorder is recording, even though the key is pressed.

Variable pitch control ON/OFF alternates between ON and OFF each time the [VARI PITCH] key is pressed in this state. “ON” or “OFF” lights up.



2. Turn the [JOG] dial to set the setting.
3. Press the [EXIT/NO] key to return to the normal display.

Setting the Speed

Note that the speed can be set only in the recorder STOP or PLAY mode. It cannot be changed when the recorder is recording. By playing back a program with the variable pitch control ON it is possible to adjust the speech while monitoring the changes.

1. Put the recorder in the STOP or PLAY mode. Press the [VARI PITCH/P.EDIT] key while the [SHIFT] key is depressed.
The current setting appears on the LCD and “%” flashes. This means that the recorder is ready to edit with the variable pitch control feature.



flashing

<Precaution>

- * You can turn ON the variable pitch function by pressing the [VARI PITCH] key, even when the current pitch data is 0.0% (state where there is no change in speed). However, this does not mean that there is any change in speed in this state. It simply means that the variable pitch function is ON.
- * The variable pitch is automatically turned OFF in the following cases:
 1. When the power is turned ON again. (the pitch data is reset to 0.0% at this time)
 2. When the [Slave Mode On/Off Setting] of the SETUP mode is turned ON. (previously set pitch data are saved)
 3. When “PROF” and “ADAT” lights up on the display while the [Digital Input Setting] in the SETUP mode is set to “S/P DIF” or “adat”.

Auto Function

The VF-16 is equipped with 3 Auto Functions. One is the “Auto Play”, which automatically starts playing a track after locating it. Another is the “Auto Return”, which locates a predetermined time during playback. The third, “Auto Repeat”, combines the former two features to repeat playing a certain segment.

Use the [ARTN/APLAY] key to start the Auto Function. Every time the key is pressed the function switches through “Auto Play” -> “Auto Return” -> “Auto Repeat” -> “OFF”. The Normal Display will show an icon of each functional status.

Auto Play

1. Press the [ARTN/A PLAY] key during the Normal Display, to display the Auto Play icon (see figure below) on the LCD.



2. Follow the above location instructions to locate a chosen point. Playback automatically starts from the time located.

Auto Return

The Auto Return function automatically locates a START point when the track is played to the END point. To execute the Auto Return function, you must set the START point and END point time.

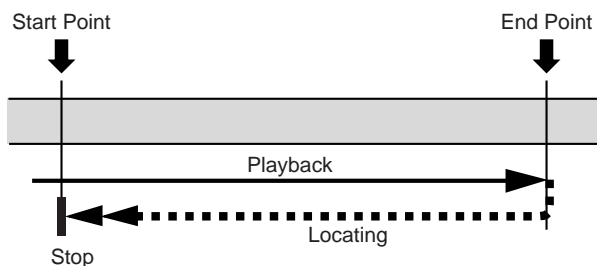

Set (Store) START/END Point

1. Press the [STORE] key at the time to set. This key can be pressed during then play or stop mode.
2. Press the [AUTO RTN-START] key or [AUTO RTN-END] key. The time is set at the respective points, and then the LCD returns to the Normal Display. The VF-16 stops when a time is stored during playback.

<Precaution>

Always set the START point time before the END point time. The Auto Return functions will not operate properly unless the start and end times are set correctly.

3. Press the [ARTN/A PLAY] key in the Normal Display to display the Auto Return icon on the LCD. (see figure below)



4. Play the VF-16 from the point immediately before the END point time. Auto Return then takes effect.

Auto Repeat

Auto Repeat is a combination of Auto Play and Auto Return. When play reaches the END point, the function automatically locates the START point.

By automatically starting to play after locating the START point, it becomes possible to repeatedly playback a certain segment.

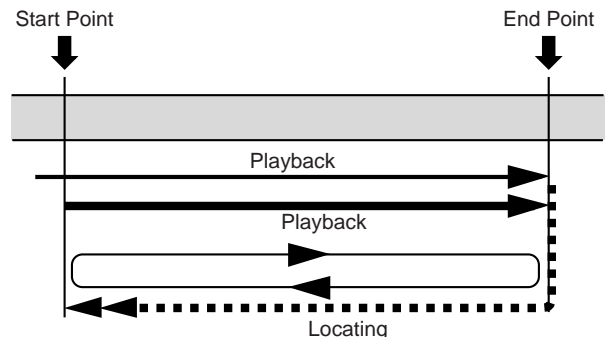

1. Set the START point time and END point time, the same as the “Auto Return” function.
2. Press the [ARTN/A PLAY] key in the Normal Display to display the Auto Repeat icon on the LCD. (as shown in figure below)



3. Start playing the VF-16 from the point immediately before the END point time set. Auto Repeat will take effect.

Program

With the VF-16, the music is managed according to programs numbered 01-99 (99 programs). These programs are independent of each other and can be recorded or played separately. This section describes the instructions of how to operate the program.

Creating a New Program

One program (P01) is automatically created on the VF-16 when formatting the hard disk. Follow the instructions below to create a New Program.

Note that the VF-16 must be in the STOP mode.

<Precaution>

The contents as the program currently started is copied as the default setting of a newly created program. To keep the same default settings as previously created programs, first start up the previous program and then create a new program.

1. Press the [PGM SEL] key in the STOP state.
The current program number and "Select PGM!" appears, then "Sure?" flashes on the LCD.

```

ABS=      00M00s
P01 [#0001
SelectPGM!          Sure?
.....+.....+ n +.....
  
```

2. Turn the [JOG] dial clockwise to find "New PGM?", then press the [ENTER/YES] key.
A new program is created, then automatically proceeds to the "Title Edit" menu of the SETUP mode. This allows the user to input (edit) the title name of the newly created program.

Press the [EXIT/NO] key twice to create a program with a working title, without editing the title.

When the [EXIT/NO] key is pressed, the system returns to the Normal Display. To edit the working title, proceed as follows.

```

ABS=      00M00s
New PGM?
SelectPGM!          Sure?
.....+.....+ n +.....
  
```

```

SETUP R03
Title Edit PGM
PGM **
[*****]
UP/DOWN JOG
←:REW          FFWD:→
Hit YES or NO Key
  
```

3. Press the [ENTER/YES] key again.
The "Tentative Title" (#0002, etc.) that was automatically assigned when creating a new program appears on the LCD. The left end of the title is highlighted and flashes.

This means that the tentative (working) title of the newly created program can be edited. Edit the title in the following manner.

Note that the "Title Edit" function described later can also edit or reedit the title of a new program already assigned a title or one that was edited.

<How to add a title!>

- * Turn the [JOG] dial at the cursor (flashing point). The following alphanumeric can be selected.
- * Shift through the cursor (flashing point) by pressing the [HOLD/>] key, [REWIND] key or [F FWD] key.

```

#%&'()*+,-./01234
56789:;<=>?@ABCDEF
GHIJKLMNOPQRSTUVWXYZ
YZ[^\_`abcdefghijklmnop
klmnopqrstuvwxyz{|
}~_!"
  
```

4. Press the [ENTER/YES] key after assigning a title.
The program is set with the title assigned.
5. Press the [EXIT/NO] key (or [STOP] key).
The user escapes from the SETUP mode and the Normal Display of the newly created program appears on the LCD.

<Notes>

- * Note that when creating a new program, the next sequential number of the program currently set on the disk is set. If there is only one program, then program number 2 (P02) is created. If there are five programs, then program number P06 is assigned.
- * The program name started when creating a new program is directly copied for the scene name (S01: #0002, etc.) appearing below the program number.
- * Available disk space is slightly reduced by creating a new program. The user cannot create a new program when there is not enough disk space available to save that program.

Selecting a Program

If there are several programs set on the disk, there may be a need to select a target program. The following instructions are based on the VF-16 in the STOP status in the Normal Display.

1. Press the [PGM SEL] key in the STOP state.
The current program number and "Select PGM!" appears, then the "Sure?" message starts flashing on the LCD.
2. Turn the [JOG] dial display to select the target program number (flashing).
"New PGM?" appears when turning the [JOG] dial clockwise. Use this to create a new program, according to the instructions as described above.
3. Select the target program number (flashing), then press the [ENTER/YES] key.
The Normal Display of the selected program appears.

Erasing a Program

The user can erase unnecessary programs. Note that there must be sufficient storage space (disk space available to store new/more data) on the hard disk to record or edit existing programs. By erasing an unnecessary program from the disk, the user can make more disk space and thus, ensure smooth operations of other functions.

1. Press the [SETUP] key in the STOP state.
The system goes to the SETUP mode and proceeds to the SETUP menu selection display.
2. Turn the [JOG] dial to select the "Delete" menu, then press the [ENTER/YES] key.
The current program number appears and "Sure?" flashes (***: Title). To cancel the ERASE procedure, press the [EXIT/NO] key while "Sure?" is flashing.

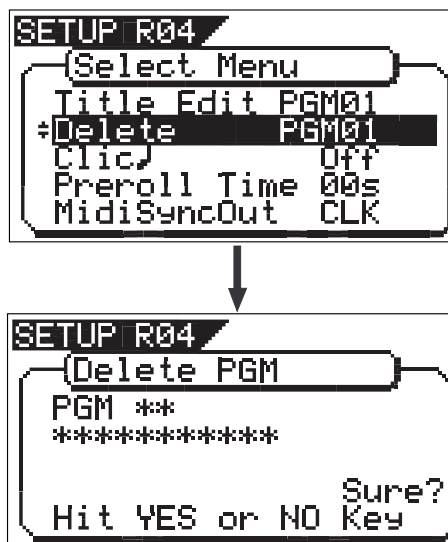

3. Press the [ENTER/YES] key.
The Normal Display of the next program following the program erased appears.

<Precaution>

- * The program started prior to executing the ERASE function is the program that is going to be erased. Therefore, the user must start the program to erase according to the "Selecting a Program" instructions, described above.
- * If a program is erased when there is only one program on the disk, then only the data saved for that program is erased. Note that an empty program 1 (P01) will remain on the disk even in such case.
- * Let's take the following case as an example. As shown in the figure below, there are five programs from P01 to P05. Note that the program numbers always remain in sequential order. Therefore, when program number P03 is erased, there will only be a total of 4 programs. This means though the data on P03 is erased, and the numbers are sequentially corrected (no number is skipped). Note that only the contents of P03 are erased and the numbers are merely reassigned in sequential order according to the number of programs available. Simply put, P04 becomes P03 and P05 becomes P04, when P03 is erased, as in this case.

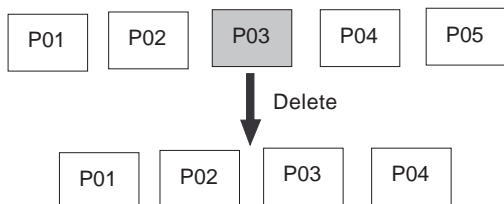

- * Remember that it is not possible to UNDO/REDO (unerase or re-erase) the ERASE feature once a program is erased.

Editing a Program Title

Note that the program title can be assigned when "Creating a New Program" as described in the previous section. However, the user must follow the instructions below to edit a title (or Tentative Title) that has already been assigned.

<Precaution>

- Note that only the title of the program that is started up can be edited.
- The user cannot choose a program from the SETUP mode. Therefore, the user must first start the program to edit, before going to the SETUP mode.

1. Press the [SETUP] key in the STOP state.
The system goes to the SETUP mode and proceeds to the display to select a SETUP menu.
2. Turn the [JOG] dial to select the "Title Edit" menu, then press the [ENTER/YES] key.
The title (name) of the current program started appears. The left end of the title is highlighted and flashes. (the flashing cursor indicates that it is editable)

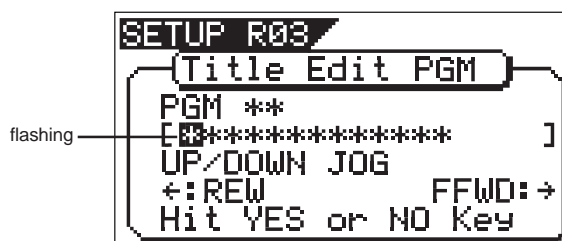

3. Press the [REWIND] key or [F FWD] key to move the cursor to the point to edit. Then turn the [JOG] dial to choose the alphanumeric/symbol to input. The title can contain up to 16 characters from the following alphanumerics and symbols.

```
#%&'()*+,-./01234
56789:;<=>?@ABCDEF
GHIJKLMNOPQRSTUVWXYZ
[\]^_`abcdefg hij
klmnopqrstuvw xyz{|
}~@_!"
```

4. Press the [ENTER/YES] key after inputting the title. The title input is set and the LCD returns to the Normal Display.

Editing the Track

The VF-16 features a 3.5 inch E-IDE hard disk as a storage media. This allows speedy voice editing in a nonlinear and nondestructive manner in track units. There are four track editing options as described below.

Copy & Paste

A specific range of data on a voluntary track can be copied and then pasted to the same track or another track. Note that the Copy & Paste feature is only possible with the current program started.

Move & Paste

A specific range of data of a voluntary track can be moved and pasted to the same track or another track. Note that the Move & Paste feature is only possible with the current program started.

Erase

A specific range of data on a voluntary track or on all real tracks are erased. Note that the Erase feature is only possible with the current program started.

Track Exchange

Tracks are interchangeable with each other. Mono tracks or several (8 track unit) tracks are exchangeable, to freely exchange between the 24 real tracks and additional tracks. Note that the Track Exchange feature is only possible with the current program started.

<Precautions>

- * DO NOT change the program during the editing process until the entire editing process is completed, since the editing process only effects the program currently selected.
- * Note that the editing process other than Track Exchange is only an option for real tracks (Trk 1-16). To edit data on additional tracks (Trk 17-24), exchange it to a real track to execute the editing process.

Copy & Paste and Move & Paste

Copy & Paste

Copy & Paste refers to the procedure to temporarily copy to a clipboard (Copy/Clip) a specific range of data on a voluntary track. That copied data can then be pasted to a specific paste point on a voluntary track. Since, the data copied remains in the clipboard even after pasting the data, that same copied data can be pasted numerous times.

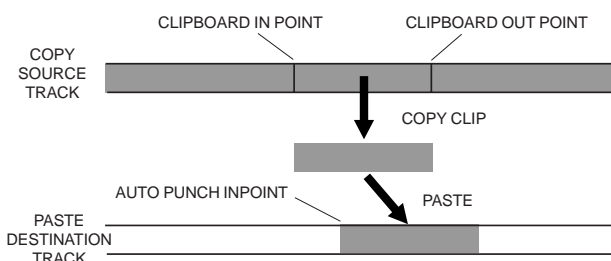

Move & Paste

Move & Paste resembles the Copy & Paste feature and refers to the procedure to temporarily move to a clipboard (Move/Clip) a specific range of data on a voluntary track. The difference between the Move & Paste and Copy & Paste feature is that with Move & Paste the original data moved can only be pasted ONCE. At the point the move data is pasted the data in the clipboard and original data is no longer available to paste again.

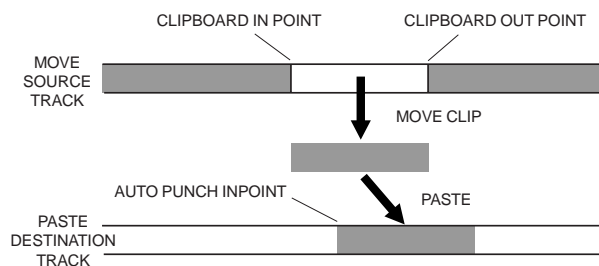

Copy & Paste and Move & Paste

This section describes the Copy & Paste (or Move & Paste) details.

<Precaution>

- * The data copied (or moved) on the clipboard is replaced with new data every time data is copied (or moved).
- * Note that the data copied in the clipboard is replaced when pasting over the original data copied.

Executing Copy (or Move) and CLIP

1. Set the point to start COPY (or MOVE) and the point to start the PASTE feature.

Set the COPY (or MOVE) starting point to the [CLIPBOARD IN] key, the ending point to the [CLIPBOARD OUT] key, and the PASTE starting point to the [AUTO PUNCH IN] key. For more details on how to set (store) to the memory key refer to the "Setting (Storing) to Memory Key" described in the "Locating Memory Key" section mentioned above.

2. Press the [EDIT] key to proceed to the "Copy Clip?" (or "Move Clip?") message.

To execute the Copy & Paste feature select "Copy Clip?".



To execute the Move & Paste feature select "Move Clip?".



3. Use the [CH STATUS/CH SEL] key to select the track to COPY (or MOVE).

Both mono tracks and multiple tracks (including ALL tracks) can be selected. During the Copy & Paste (or Move & Paste) process it is only possible to change the paste destination track of mono tracks or when copying (or moving) with two tracks that are odd and even number tracks situated next to each other. In any other case, when copying (or moving) multiple tracks, the data is pasted to the original copy site (or move) of the same track.

4. Press the [ENTER/YES] key. Press the [ENTER/YES] key to complete the data copy (or move) process. "Completed!" appears on the display then the "CopyPaste" (or "Move Paste") message flashes. This means that the sound data has been copied (or moved) to the clipboard, and that the system is ready to proceed to the following paste process.

The recorder is ready to paste if there is no problem with the COPY/CLIP (or MOVE/CLIP) process. At this stage, it is possible to check the sound data in which COPY/CLIP (or MOVE/CLIP) was executed.

To check the data on the clipboard, refer to the instructions described in "Checking Data in the Clipboard".

<Precaution>

- * If COPY (or MOVE) is executed without selecting a track to COPY (or MOVE), then "Select Track!" will appear on the LCD with a flashing "Copy Clip!" (or "Move Clip!") message. In this case, repeat the procedure by using the [CH STATUS/CH SEL] key to choose the track to COPY (or MOVE).
- * If the CLIPBOARD IN point and CLIPBOARD OUT point is stored in the reverse time relationship when attempting to COPY (or MOVE), then a "Void IN Point!" or "Void OUT Point!" warning appears on the display and prevents any further process. In such case, reset the proper time relationship of the CLIPBOARD IN/OUT points prior to COPY (or MOVE).

<Check the Clipboard Data>

Prior to pasting any sound data, follow the instructions below to check for the presence of any sound data copied (or moved) on the clipboard.

- * Press the [PLAY] key while the [STOP] key is depressed. The sound data copied or moved on the clipboard appears (if the data is copied "Copy Clip Play!" appears, and if it is moved data then "Move Clip Play!" appears), and that data is played (clipboard play). To monitor the sound played, make the adjustments with the channel fader corresponding to the track copied (or moved). The [CH STATUS/CH SEL] key that was copied (or moved) flashes during playback. The recorder automatically stop when clipboard play is over.
- * Press the [EDIT] key after checking the data. When the earlier mentioned COPY (or MOVE) is completed, the LCD will then return to the same display (flashing "Copy Paste" or "Move Paste").

Pasting Data

5. Press the [ENTER/YES] key when "Copy Paste" (or "Move Paste") is flashing.

The menu to select the paste repeat frequency appears ("Repeat = 01"), then "01" and "Sure?" flashes. (Note that "01" refers to paste once.) The [CH STATUS/CH SEL] key of the track copied (or moved) flashes.



or



6. Use the [CH STATUS/CH SEL] key to select the paste destination track.
 - * There is no need to select a track when pasting on the same track.
 - * The mono track is the only track in which the paste destination can be changed. The other condition in which the paste destination can be changed is when the data from two tracks (odd and even) next to each other (1-2, 3-4, 5-6, 7-8, etc.) are copied (or moved) on the clipboard. The paste destination track can be changed by pressing the [CH STATUS/CH SEL] key in this case.

- * Note that it is not possible to paste to the same track that was copied (or moved) when copying (or moving) multiple tracks (1-3, 5-8, etc.), although it was possible in the cases described earlier. In this case, the track will not be changed even if the [CH STATUS/CH SEL] key is pressed.
7. Turn the [JOG] dial to choose the paste repeat frequency. The desired number can be input in the "01" area of the "Repeat = 01" that is currently flashing. The maximum repeat frequency that can be input is 99 but this repeat frequency is automatically limited according to how much space is available on the disk. Simply put, a frequency of 99 repeat times can be input if there is enough disk space. If there isn't, then only the maximum allowable repeat frequency (size) for the remaining disk space can be input. It is not possible to go above this number even if the [JOG] dial is turned.
 8. Press the [ENTER/YES] key. "Copy Paste" (or "Move Paste") flashes on the display. "Please Wait!" flashes while the data is being pasted. "Completed!" lights up when the data has been successfully pasted.
 9. Press the [EXIT/NO] key (or [STOP] key). The system exits from the edit mode and returns to the original time base display.

UNDO/REDO Paste

Copy & Paste or Move & Paste can be undone and redone with the UNDO/REDO feature.

- * The data pasted can be undone (unpasted) by pressing the [UNDO/REDO] key after Copy & Paste (or Move & Paste). The data will return to the pre-paste status when undone (unpasted).
- * Data pasted but undone (unpasted) can be redone (re-pasted) by pressing the [UNDO/REDO] key immediately after undoing the paste process. The data will return to the post-paste status when re-done (re-pasted). Note the following when executing the UNDO/REDO feature.

<Caution>

The UNDO/REDO feature is valid only when the recorder is in the STOP state. UNDO/REDO is no longer possible if the following procedures take place after Copy & Paste (or Move & Paste).

1. When data is newly recorded.
2. When data is newly edited.
3. When the AUTO PUNCH mode is ON and PLAY (or RECORD) mode is effected, and the point has already passed the AUTO PUNCH IN point.
4. When the power is turned OFF.
5. When program selection takes place.

<Caution>

Note that Copy & Paste (or Move & Paste) is not possible unless there is enough disk space to "UNDO/REDO", as explained in the next section. When attempting to paste to a disk that does not have enough disk space, "Over Time!" appear on the display and the insufficient time appears according to the currently selected time base. In such case, either shorten the COPY DATA (or MOVE DATA) by the time it is in the excess, or erase unnecessary data or programs from the erase to secure enough disk space. Then repeat the paste procedure. Refer to the "Erasing a Program" on page 62 for instructions on how to erase a program, in terms of the "ERASE" instructions to erase unnecessary data.

< Please note >

For regular copy & paste (or move & paste) as shown in Figure 1, the CLIPBOARD IN point of the data which was copy clipped (or move clipped) onto the clipboard, is aligned with the AUTO PUNCH IN point and pasted.

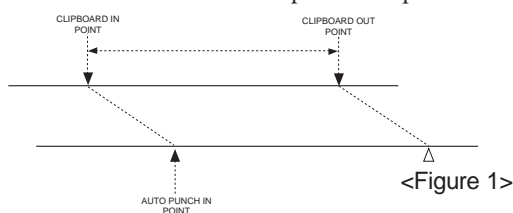

Due to this, as shown in Figure 2, in the case whereby data registered in the CLIPBOARD is the actual sound point and head of the measure is behind this, then even though you attempted to paste this head of the measure in alignment with this previously head, it will be pasted off alignment by this procedure due to the CLIPBOARD IN = ALIGN SEL function.

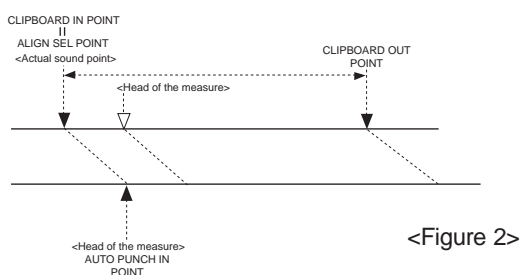

To align the head of the measure for pasting together with sound data in front of the measure, the "ALIGN SEL" function of VF-16 can be utilized. To use this function, the head of the measure data in the clip data must be registered in the [ALIGN SEL] key as shown in Figure 3.

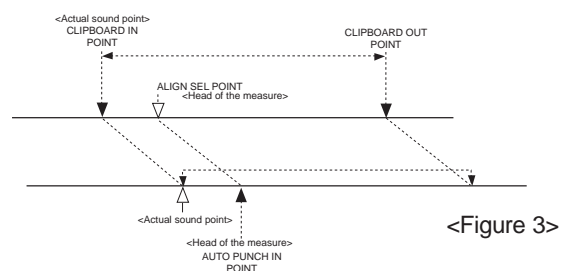

CLIPBOARD IN data, as a result of copy clip (or move clip), will be directly registered in the [ALIGN SEL] key. Next, recall the [ALIGN SEL] key data (press the [ALIGN SEL] key) and, after correcting this data to head point of the measure, press the [STORE] key and then the [ALIGN SEL] key. After this, by executing copy & paste (or move & paste), the aligned heads of the measures together with data in front of the measures, can be pasted.

< Note >

The range in correction of the ALIGN SEL data must be strictly limited between CLIPBOARD IN-OUT.

Erase

The VF-16 provides the following “ERASE” options. Please read the instructions in its entirety prior to actual operations, to prevent any erroneous understanding of the description. First, start the desired program if there are several programs set. DO NOT change a program in the middle of the erase procedure.

Erasing a selected section between ABS - REC END.

A selected section between ABS 0 (beginning of disk) and REC END (REC end point) is erased of the program currently started up.

Both mono tracks and multiple tracks (including all real tracks) can be erased if assuming that they are real tracks. To erase data, it needs to first be on a real track.

When erasing a selected section between ABS 0 - REC END, END of recording point remains unchanged as shown in the figure below. Only the section erased of data (meaning there will be no sound on that section) will be erased. Once the data is erased there will be more disk space remaining on the disk (more storage space to save new data).

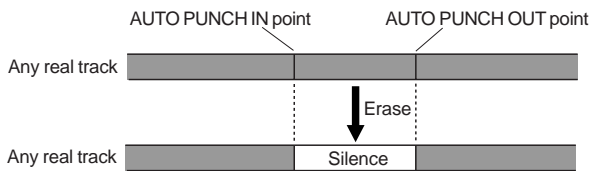

Erasing from a voluntarily specified point to REC END.

All data from a voluntarily specified point (other than ABS 0) to REC END is erased from the currently started program. Both mono tracks and multiple tracks can be erased, as in the case described to the left.

When erasing all tracks to REC END, the REC END point moves forward.

However, the REC END point may not move forward (Refer to <Precautions> on this page for more details) even when erasing data on multiple tracks that are not mono tracks or all tracks.

Note that the disk space remaining increases as in the case to the left, after data is erased from a section.

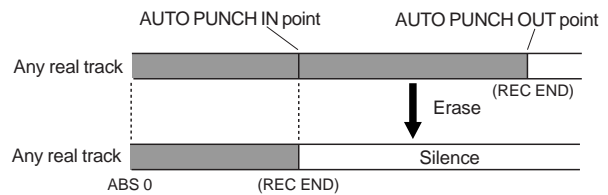

<Precautions Upon Erasing Data>

As in the case below, if data is recorded on real tracks 1 to 7, and data is erased from tracks 1 and 2, then the REC END, which the VF-16 recognizes, remains the same before and after erasing data.

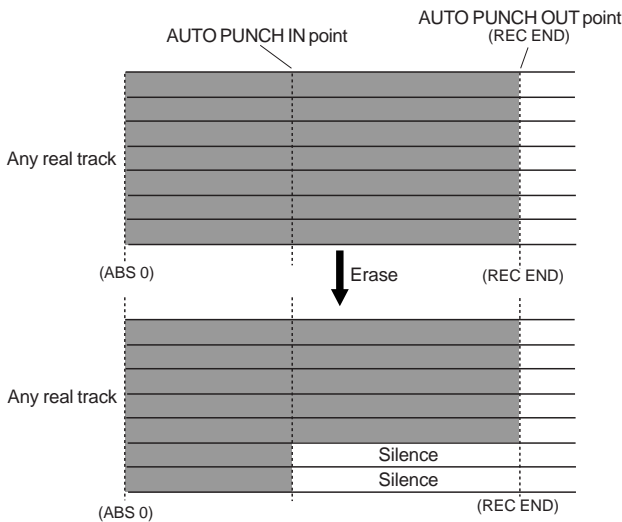

On the other hand, if data is erased from tracks 3 to 7 as shown in the figure below, the REC END point after erasing data will be positioned at the REC END point of tracks 1 and 2. In other words, the REC END point prior to erasing data moves, after the data is erased.

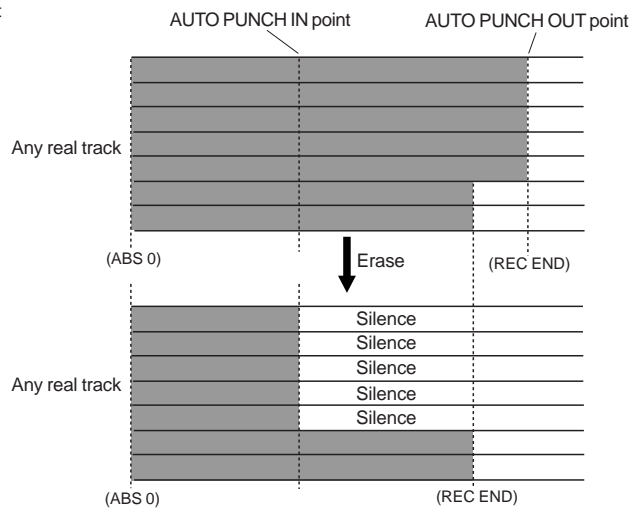

Erasing Data

- Set the starting point and ending point of the section to erase.
Set the starting point to erase to the [AUTO PUNCH IN] key, and the ending point to erase to the [AUTO PUNCH OUT] key.
For more details on setting data to the memory key refer to the section on “Storing to Memory Key” described in the “Locating Memory Key” item.
- Press the [EDIT] key in the STOP state. Then select “Erase?”.

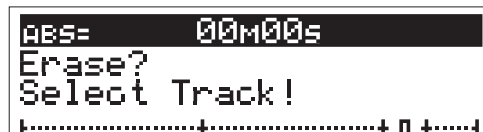

- Use the [CH STATUS/CH SEL] key to select the track to erase.
Mono tracks or multiple tracks (including all real tracks) can be selected to ERASE. The [CH STATUS/CH SEL] key of the track selected flashes.

4. Press the [ENTER/YES] key.
“Sure?” flashes.



5. Press the [ENTER/YES] key once again.
The erase process will take place. “Wait Erasing!” flashes on the display while data is being erased. “Completed!” lights up on the display when the data is successfully erased.
6. Press the [EXIT/NO] key (or [STOP] key).
The LCD returns to the Normal Display prior to the editing mode.

<Remember!>

To erase all data between ABS 0 and REC END, it is recommended that the time after REC END is set as the ERASE end point (AUTO PUNCH OUT point) to ensure that all the data is completely erased. In such case, move the current location of the recorder to the REC END point prior to setting the AUTO PUNCH OUT point and then press the [PLAY] key from that REC END point to move the REC END point slightly forward. Then press STOP. By setting that STOP point (time) to the [AUTO PUNCH OUT] key, it becomes possible to thoroughly erase all data from that section. The hard disk does not access any point after the REC END point, even when PLAY is started. When there is no data on that section, only the time will be counted.

UNDO/REDO Erase

The erase procedure can be undone and redone with the UNDO/REDO feature.

- * Data erased can be undone (unerased) by pressing the [UNDO/REDO] key after ERASE. The data will return to the pre-erase status.
- * The data erased but undone (unerased) can be redone (re-erased) by pressing the [UNDO/REDO] key immediately after undoing the erase process. The data will return to the post-erase status.

Note the following when executing the UNDO/REDO feature.

<Precautions>

The UNDO/REDO feature is valid only when the recorder is in the STOP state.
UNDO/REDO is no longer possible if the following procedures take place after ERASE.

1. When data is newly recorded.
2. When data is newly edited.
3. When the AUTO PUNCH mode is ON and PLAY (or RECORD) mode is effected, and the point has already passed the AUTO PUNCH IN point.
4. When the power is turned OFF.
5. When program selection takes place.

Track Exchange

“Track Exchange” allows the tracks currently on the program to be interchanged (all real tracks and additional tracks) on mono track or multiple track (8 tracks each) units.

This function makes it possible to exchange real tracks. A real track can be emptied by moving a real track to a blank additional track. This means that real track can be recorded with other data. All-in-all, track exchange allows effective utilization of the tracks.

As already described in the “Erase” section, the “Track Exchange” feature is necessary to check the REC END point of an additional track.

Executing Track Exchange

1. Press the [EDIT] key while the recorder is in the STOP state, and show “Track Exchange?” on the display.



2. Next press the [ENTER/YES] key.
The track exchange selection display appears.
The current display indicates that track 1-8 and track 9-16 can be exchanged in 8 track units.
To select another combination, go to the next step, respectively.



flashing

When exchanging tracks 1-8 and tracks 17-24.

1. Press the [HOLD/>] key, [REWIND] key or [F FWD] key to move the flashing “01-08” (left) to “09-16” (right) that is flashing.

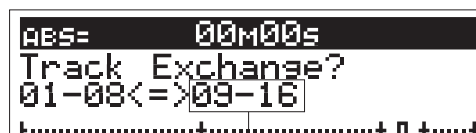

flashing

2. Turn the [JOG] dial to select “17-24” to flash on the display.
Tracks “09-16” and “17-24” can alternately be selected by turning the dial.

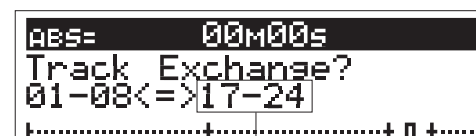

flashing

3. Press the [ENTER/YES] key.
The tracks are instantly exchanged.
“Completed!” appears on the display when the tracks are successfully exchanged. Then the LCD returns to the original time base display.

When exchanging mono tracks.

1. Turn the [JOG] dial while “1-8” is flashing.
By turning the [JOG] dial to the left and right it is possible to select the mono track numbers “1”, “2”, “3”, “4” ... “24” other than “01-08”. At the same time, the display on the right also shows the mono track display.
If, for example, the [JOG] dial is turned to “4” for the left track number, then “Track Exchange 4<->1” appears on the display. This means track 4 and 1 can be exchanged.

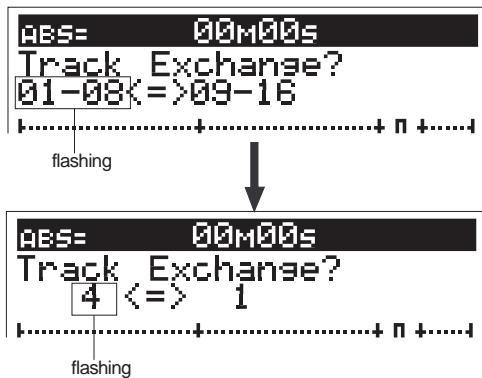

2. To select a track number on the right, press the [HOLD/ >] key, [REWIND] key, or [F FWD] key to move the flashing point (cursor). Use the [JOG] dial to choose the number desired.

<Note>
The numbers on the right and left of mono tracks mean the same thing, therefore, the numbers can be reversed and still mean the same thing. In other words, “Track Exchange 4<->1” and “Track Exchange 1<->4” mean the same thing. This representation means that tracks 1 and 4 will be exchanged, regardless of which number comes first.

<Caution>
Note that the same tracks on the left and right cannot be exchanged on mono track units. Even if selected, the operation will be invalidated and result in an error message. If the same track is erroneously specified and executed, a “Select Err” message instantaneously appears on the LCD, and then returns to the state prior to the error state.

3. Press the [ENTER/YES] key.
The tracks are instantly exchanged.
“Completed!” appears on the display when the tracks are successfully exchanged. Then the LCD returns to the original time base display.

Chapter 5 Features Application

Applications of DIRECT RECORD

This section describes applications of the DIRECT RECORD feature.

DIRECT RECORD while listening to the input signal

DIRECT RECORD basically takes place with the play [TRACK] started for all the channel faders. However, it is also possible to start [INPUT] signals A to H. Here we will DIRECT RECORD to tracks 1 to 16, while monitoring the counter and listening to a rhythm machine (in this case, a drum machine) from input H.

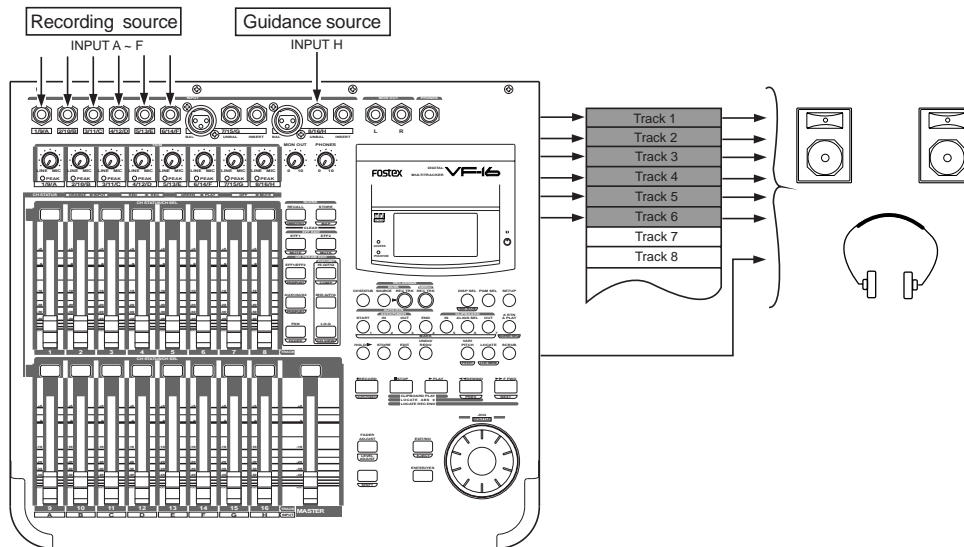

Connecting the sound source

1. Connect the OUT of the drum machine to [INPUT] H.
2. Connect the sound sources to record to [INPUT] A to F.

Setting the input signal to INPUT H

1. Press the [INPUT SEL] key (ORANGE: Flashing).
2. Press the [CH STATUS/CH SEL] key of ch16 so it flashes ORANGE (ch16-> INPUT).
3. Press the [EXIT/NO] key to return to the Normal Display.
4. Set the ch16 fader and master fader to "0".
5. Start the drum machine and then adjust the [TRIM] of 8/16/H.
The input signals of [INPUT] H are output from the L/R stereo OUT. Use the [MON OUT] knob or [PHONES] knob to increase the volume to an appropriate level.

Setting the input signals to INPUT A to F

1. Press the [DIRECT-REC TRK] key, then choose a track to record with the [CH STATUS/CH SEL] key. (RED: Flashing)
Press the [CH STATUS/CH SEL] key of ch1-ch6 so tracks 1-6 will be READY.
2. Press the [EXIT/NO] key to return to the Normal Display.
3. Set ch1-ch6 faders to "0".

4. Press the [RECORD] key and then set the READY track to input monitor (RED: Flashing).
By using the input monitor, it is possible to monitor the sound sources of ch1-ch6 and the INPUT H signals, at the same time. Set the PAN as desired so it is easy to monitor the sound.

5. Adjust the [TRIM] of each channel while outputting the sound source.
Set the input level of each sound source, then proceed to the next REC process.

Record

1. To start recording, press the [PLAY] key while the [RECORD] key is depressed.
Sounds are DIRECTLY RECORDED to tracks 1-6 according to the guidance sounds of input H.

<Caution>

* If the ch16 fader is set to "INPUT", then track 16 cannot enter READY status which means recording will not be possible. If, for example, all faders of ch9-ch16 are set to [INPUT], then recording is no longer possible on tracks 9-16. Note that this does not affect any signal already recorded on tracks 9-16.

* The fader of ch16 merely adjusts the level of the H [INPUT] signal sent to stereo OUT. Therefore, it does not adjust the level of the signals recorded.

Applications of BUSS RECORD

BUSS RECORD makes it possible to record all the source channel signals sent to REC BUSS L/R on either 2 tracks or 1 track. The source channel is selectable with the "INPUT" channel and "TRACK" channel, therefore, it is possible to record the input signals along with signals that are already recorded.

Record by mixing the input sound and play sound

Here, we will mix the play sounds of tracks 1-4 with the signals input through [INPUT] A-D to record on tracks 7 and 8.

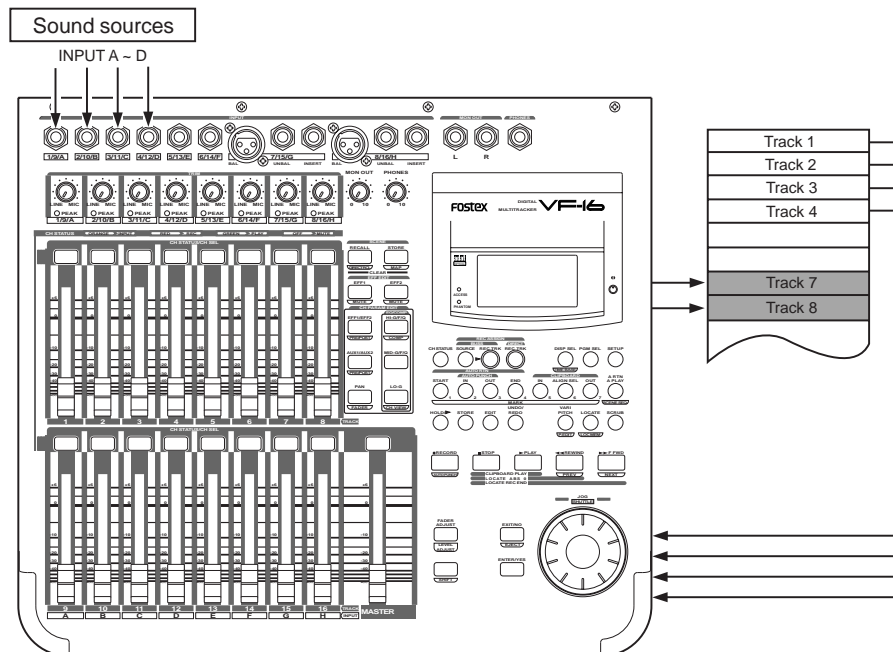

Connecting the sound source

1. Connect the sound sources to record to [INPUT] A to D.

Preparations to record

1. Press the [INPUT SEL] key (ORANGE: Flashing).
The display to select "INPUT" - "TRACK" appears.
2. Press the [CH STATUS/CH SEL] key of ch9-ch12 so it flashes ORANGE (ch9-ch12 -> "INPUT").
3. Press the [BUSS-SOURCE] key (GREEN: Flashing).
The display to select the source channel appears.
4. Press the [CH STATUS/CH SEL] key of ch1-ch4 and the [CH STATUS/CH SEL] key of ch9-ch12.
Ch1-4 and ch9-12 are set to the source channel.
5. Press the [BUSS-REC TRK] key (RED: Flashing).
The display to select the REC track appears.
6. Press the [CH STATUS/CH SEL] key of ch7 and ch8.
Ch7 and ch8 are set as the REC track. The signals from ch1-4 and ch9-12 can not be recorded to tracks 7 and 8.
7. Press the [EXIT/NO] key to return to the Normal Display.
8. Set the ch1-4, ch 7&8, and ch9-12 fader and master fader to "0".
9. Press the [RECORD] key to go to the input monitor (RED: Flashing).

10. Set the ch7/8 fader and PAN that is used to monitor the REC track.

Set the ch7 PAN to the LEFT (L) and ch8 PAN to the RIGHT (R). The position of the recorded signal can be checked.

11. Adjust the faders, PAN, equalizer and effect of each source channel (ch1-4 and ch9-12).

The sound is recorded on track 7 by setting the source channel PAN to the LEFT. The sound is recorded on track 8 by setting the source channel PAN to the RIGHT. The sound is recorded on both tracks by setting the source channel PAN to the CENTER.

When the preparations to record have been completed, start recording according to the basic "BUSS RECORD" instructions described earlier.

How to adjust the REC BUSS Master Level

To adjust the REC BUSS Master Level, press the [BUSS-REC TRK] key then use the [JOG] dial while the following display is shown. The default setting of the REC BUSS Master Level is set to "80". However, this can be modified to a voluntary REC BUSS Master Level with the [JOG] dial. After adjusting the level, press the [EXIT/NO] key. The Normal Display appears. The master level during recording appears on the level meter shown on the display below.

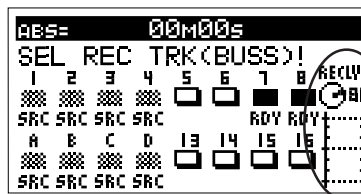

Ping-Pong RECORD

By using BUSS RECORD, it is possible to select a maximum of 15 source channels when recording to 1 track and a maximum of 14 source channels when recording to 2 tracks. Here we will ping-pong record the sound recorded on tracks 1-14 onto tracks 15 and 16 for temporary mix down. Ping-pong RECORD refers to the process in which the sound of several tracks are mixed and then recorded on another track.

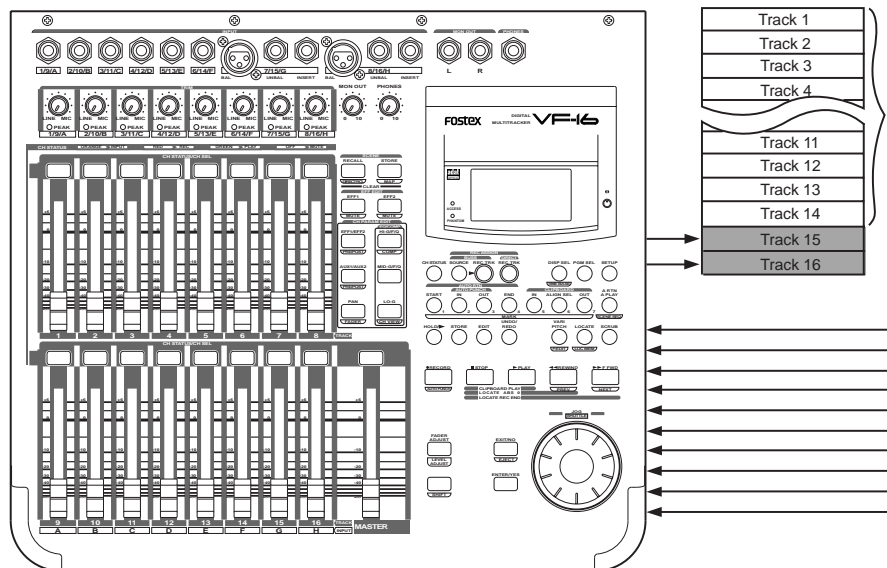

Preparations to record

1. Press the [INPUT SEL] key (ORANGE: Flashing).
The display to select "INPUT" - "TRACK" appears.
2. Press the [CH STATUS/CH SEL] key of ch9-ch16 so it flashes GREEN (= "TRACK").
3. Press the [BUSS SOURCE] key (GREEN: Flashing).
The display to select the source channel appears.
4. Press the [CH STATUS/CH SEL] key of ch1-ch14.
Ch1-8 and ch9-14 are set to the source channel.
5. Press the [BUSS-REC TRK] key (RED: Flashing).
The display to select the REC track appears.
6. Press the [CH STATUS/CH SEL] key of ch15 and ch16 (RED: Flashing).
Tracks 15 and 16 are set to the READY track.
7. Press the [EXIT/NO] key to return to the Normal Display.
8. Press the [RECORD] key to go to the input monitor (RED: Flashing).
9. Set the ch15/16 fader and PAN that is used to monitor the REC track.
Set the ch15 PAN to the LEFT (L) and ch16 PAN to the RIGHT (R). The position of the recorded signal can be checked.
10. Adjust the faders, PAN, equalizer and effect of each source channel (ch1-14 and ch9-12).
The sound is recorded on track 15 by setting the source channel PAN to the LEFT.
The sound is recorded on track 16 by setting the source channel PAN to the RIGHT.
The sound is recorded on both tracks by setting the source channel PAN to the CENTER.
11. To start recording, press the [PLAY] key while the [RECORD] key is depressed.

How to adjust the REC BUSS Master Level
To adjust the REC BUSS Master Level, press the [BUSS-REC TRK] key then use the [JOG] dial while the following display is shown. The default setting of the REC BUSS Master Level is set to "80". However, this can be set to a voluntary REC BUSS Master Level with the [JOG] dial. After adjusting the level, press the [EXIT/NO] key. The Normal Display appears. The master level while recording appears on the level meter shown on the display below.

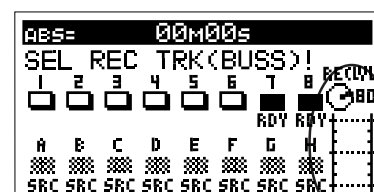

Metronome Function

The VF-16 incorporates a tempo map to set a desired bar/beat (4/4, 3/4, etc.) and tempo (30-250). It is possible to output a metronome sound, according to the setting of the tempo map. This allows for recording in sync with the rhythm output from the VF-16 without having to use an external metronome or rhythm box.

Setting the tempo map

The user must first set the tempo map to output metronome sound. The tempo map can be set through the "Beat Setting" menu and "Tempo Setting" menu of the SETUP mode. The default setting of the tempo map is set to 4/4 bar/beat with a tempo of 120. The following procedures are unnecessary if the default setting does not have to be modified. The tempo map of the default setting means that the metronome sound will always click at a 4/4 beat and 120 tempo.

1. Press the [SETUP] key when the VF-16 is in the STOP mode, to go to the SETUP mode.
The display to select a SETUP menu appears.
2. Use the [JOG] dial to select the "Signature Set" menu, then press the [ENTER/YES] key.
The menu to set the beat appears. Refer to "Setting the Beat" on page 99 for more details on how to customize the beat setting.
3. After setting the beat, press the [EXIT/NO] key to return to the SETUP menu.
4. Use the [JOG] dial to select the "Tempo Set" menu, then press the [ENTER/YES] key.
The menu to set the tempo appears. Refer to "Setting the Tempo" on page 101 for more details on how to customize the tempo setting.
5. After setting the tempo, press the [EXIT/NO] key to return to the SETUP menu.
Next, proceed with the "Setting Metronome Output" procedure.

Setting metronome output

The next step is whether to set the system to output metronome sound or not. This is done in the same manner as setting the tempo map and is set from the "Metronome Function Setting" menu in the SETUP mode.

1. Use the [JOG] dial to select the "Click?" menu, then press the [ENTER/YES] key.
The currently set item (On or Off) flashes.
The default setting is set to "Off".
2. Use the [JOG] dial to select "On" (flashing), then press the [ENTER/YES] key.
The metronome function is now turned "On".
3. When the setting has been completed, press the [EXIT/NO] key twice to escape from the SETUP mode.

Set the time base to the BAR/BEAT.

1. Press the [DISP SEL] key while the [SHIFT] key is depressed to switch the time base display to the "BAR/BEAT" display.
It is possible to check the bar/beat set in the tempo map by switching to the "BAR/BEAT" display.

Checking metronome sound

1. Press the [PLAY] key to play the VF-16.
The metronome sound level appears on the level meter of ch16. At this time, turn up the master fader and fader of ch16 to "0", then use the [PHONES] knob or [MON OUT] knob to turn up the volume, to monitor the metronome sound.

It is possible to output the metronome sound from ch16 as described above. It is also possible to use the metronome sound as a guide to record to ch1-15.

Use the ch16 fader to adjust the output level of the metronome sound (clicking sound).

<Note>
The metronome sound (clicking sound) cannot be heard unless ch16 is set to "TRK (Track)". Press the [INPUT SEL] key to see that ch16 is set to "TRK", as shown in the display on the left.

<Caution>
When the metronome function is no longer necessary, always go to the SETUP mode to turn OFF the metronome function. As long as the metronome function is ON, it is not possible to record on track 16, and any sounds already recorded on track 16 cannot be played.

Digital Recording

This section will describe digitally recording from the VF-16 to external digital devices or to digitally record from external digital devices that are connected to the [DATA IN]/[DATA OUT] jack of the VF-16. Digital signals recorded are either S/P DIF or adat digital signals.

Digital recording from an external digital device

This section describes digitally record from an external S/P DIF digital device (CD, MD, DAT, etc.) or adat digital device (Fostex D-1624, D-824, VC-8, VM88, etc.) to the VF-16.

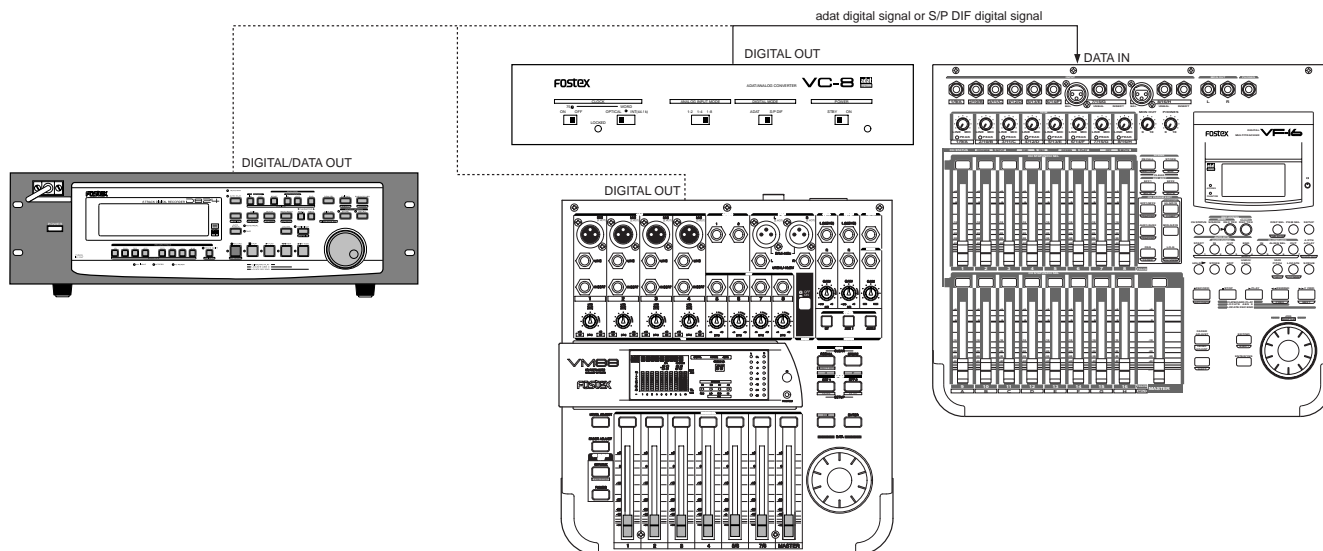

<Caution (IMPORTANT)>

To digitally record to the VF-16, only input digital signals (S/P DIF or adat) with the same sampling rate (44.1kHz/16bit) as the VF-16.

<When recording adat digital signals>

Set the "Digital In" of the SETUP mode to "adat".

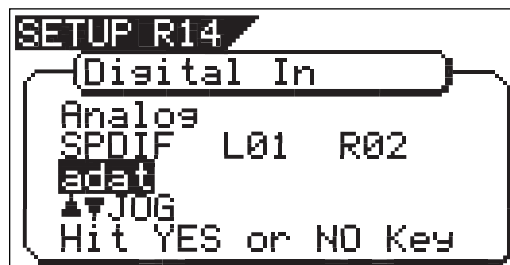

Selecting the program to record

If several programs are set, use the program selection function to pre-start the program to record.

Setting the digital input

1. Set the VF-16 digital input as shown below, from the "Digital In" menu in the SETUP mode. For more details on setup procedures refer to the "SETUP Mode" on page 107.

<When recording S/P DIF digital signals>

Set the "Digital In" (SPDIF) of the SETUP mode, as shown as an example below. With this setting the LEFT channel of the S/P DIF digital signal is recorded on track 1 and the RIGHT channel is recorded on track 2.

As shown in this case, when selecting a S/P DIF digital signal it is possible to set odd and even tracks next to each other.

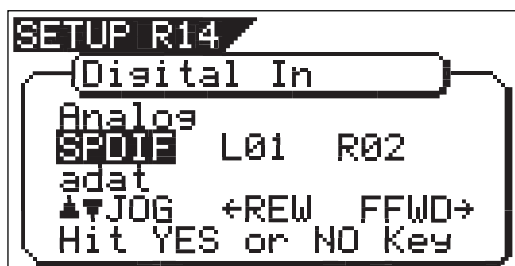

This setting records the adat digital signals on ch1-ch8 on tracks 1-8. In other words, the ch1 signals are recorded on track 1, ch2 signals on track 2, and so on. Simply put, the digital signal is recorded on tracks corresponding to the adat digital signal channel.

2. When the "Digital In" settings are completed, press the [EXIT/NO] key to escape from the SETUP mode. The LCD shows the Normal Display.

Either "ADAT" or "SPDIF" lights up on the display, when proper digital signals (S/P DIF or adat) from an external digital device is input in DATA IN.

If either "ADAT" or "SPDIF" flashes on the display it means that the digital signal input is incorrect. In such case check the connection cable and digital output setting of the external device.

<Caution (IMPORTANT)>

Do not make connections such as for input of S/P DIF digital signals into the VF-16 DATA IN connector when "Digital In" is set to "adat". It could result in abnormal symptoms such as reduction in operating speed of VF-16 and also create noise.

Selecting a track to record

Digital recording is only an option of "DIRECT RECORD" that was described in the section on basic recording choices. It is not possible to apply equalization or effect on the signals recorded.

1. Press the [INPUT SEL] key. Check to see that ch9-ch16 are all set to "TRK".
If any channel is set to "IN", modify the setting to "TRK".
2. Press the [DIRECT-REC TRK] key.
The display to select the REC track appears.
3. Press the [CH STATUS/CH SEL] key of the track that was set with "Digital In".
The [CH STATUS/CH SEL] key of the channel selected flashes RED.
4. Press the [EXIT/NO] key to return to the Normal Display.

Starting to record

1. Turn up the channel fader and master fader corresponding to the track recorded to "0".
2. Press the [PLAY] key while the [RECORD] key is depressed to start recording with VF-16, as well as start playing the external digital device.
The level meter of the digital signal level that is currently input will appear. There is no need to adjust the input level on the VF-16 for digital recording.
3. Turn up the [PHONES] knob or [MON OUT] knob to monitor the sound.
4. When recording is completed, press the [STOP] key to stop the VF-16 and to stop the external digital device.

<Important>

If the track for digital recording is set from the "Digital In" menu of the SETUP mode, then tracks not assigned for digital REC can record analog signals at the same time.

For example, if S/P DIF digital signals are recorded on tracks 1 and 2, it would then be possible to record analog signals on the remaining tracks 3-16.

With this function, it is possible to simultaneously record 16 tracks with adat digital and analog signals. However, the prerequisite is that "DIRECT RECORD" is the recording option being used. For further details, refer to the section on "Recording 16 Tracks at the Same Time" described below.

Recording 16 Tracks at the Same Time

This section describes how to simultaneously record a total of 16 tracks consisting of 8 analog signals and 8 adat digital signals. Simply put, tracks 1-8 record the adat digital signals from VC-8 or VM88 and tracks 9-16 DIRECT RECORD the 8 analog signals.

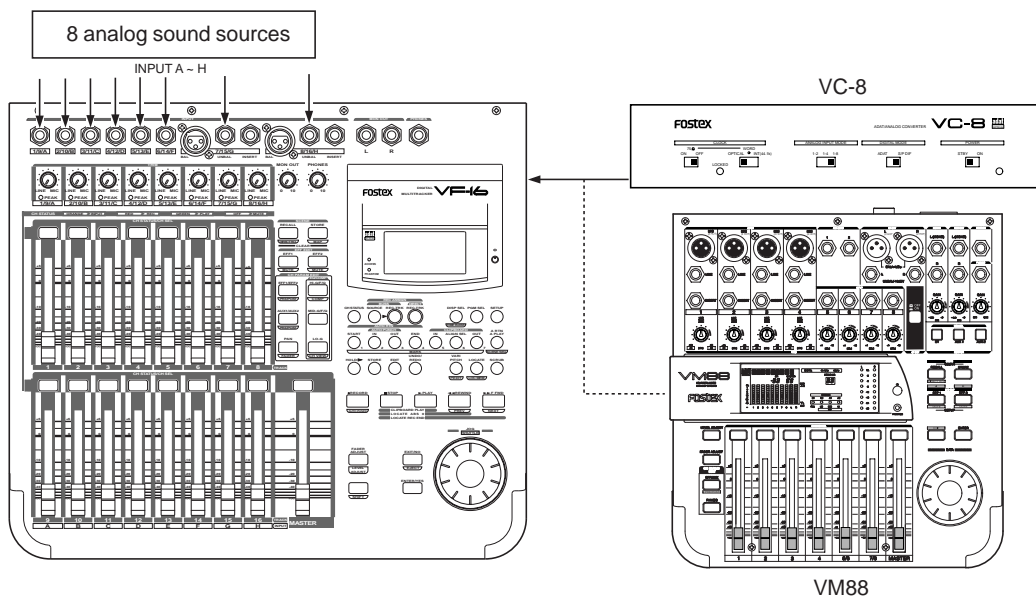

Connecting a Sound Source or External Device

1. Connect the VC-8 or VM88 to the [DATA IN] jack of the VF-16.

2. Connect 8 sound sources into [INPUT] jacks A to H.

Setting the VC-8 or VM88

1. Set the VC-8 or VM88 so it outputs adat digital signals.
For more details refer to the VC-8 or VM88 User's Manual.

Setting "Digital In" on the VF-16

1. Set the "Digital In" menu in the SETUP mode to "adat".
For more details refer to the SETUP mode on page 107.

REC Track and Master Fader settings

1. Press the [INPUT SEL] key.
Check to see that ch9-ch16 are set to "TRK (Track)".
If there is any channel that is set to "IN (Input)" switch it to "TRK".
2. Press the [DIRECT-REC TRK] key, so all tracks are READY.
The REC track selected will appear on the display.
3. Press the [CH STATUS/CH SEL] key of ch1-ch16 so all tracks are READY.
Now the adat digital signals (ch1-ch8) from VC-8 (or VM88) are recorded on tracks 1-8 and the input signals from [INPUT] A to H are recorded on tracks 9-16.
4. Press the [EXIT/NO] key and return to the Normal Display.
If normal adat digital signals from VC-8 (or VM88) are input into VF-16, "ADAT" lights up on the Normal Display.
5. Set the master fader to "0".

Check adat signal and adjust monitor

1. Press the [RECORD] key.
All tracks go to the input monitor status.
If signals are input from the VC-8 (or VM88) in this state, the input level appears on the level meters 1-8.
To monitor the adat signals, turn the ch1-ch8 channel fader up to "0", and then turn up the [MON OUT] knob or [PHONES] knob.
There is no need to adjust the REC level on the VF-16.
The channel fader procedures only adjust the monitor sound.

Setting the analog input signal setting

1. Set the channel fader of ch9-ch16 to "0".
2. Adjust the input level with the [TRIM] for which each sound source is input.
Fine tune the input with the channel fader if necessary.
The monitor sound can also be heard at this time.

Starting to record

1. To start recording, press the [PLAY] key while the [RECORD] key is depressed.
When recording starts, the adat digital signals from VC-8 (or VM88) are input along with the signal input of the analog sound source.
This allows recording of 8 analog signals (8 channels) and 8 adat digital signals (8 channels) for recording on 16 tracks at the same time.

MIDI clock sync system

By setting any desired meter at any desired point of the programmable tempo map contained in the VF-16, and by output of a MIDI clock and song position pointer according to the setting, a hardware type MIDI sequencer can be synchronized as a MIDI clock slave. Consequently, in this system, the VF-16 will be the master and the MIDI sequencer the slave.

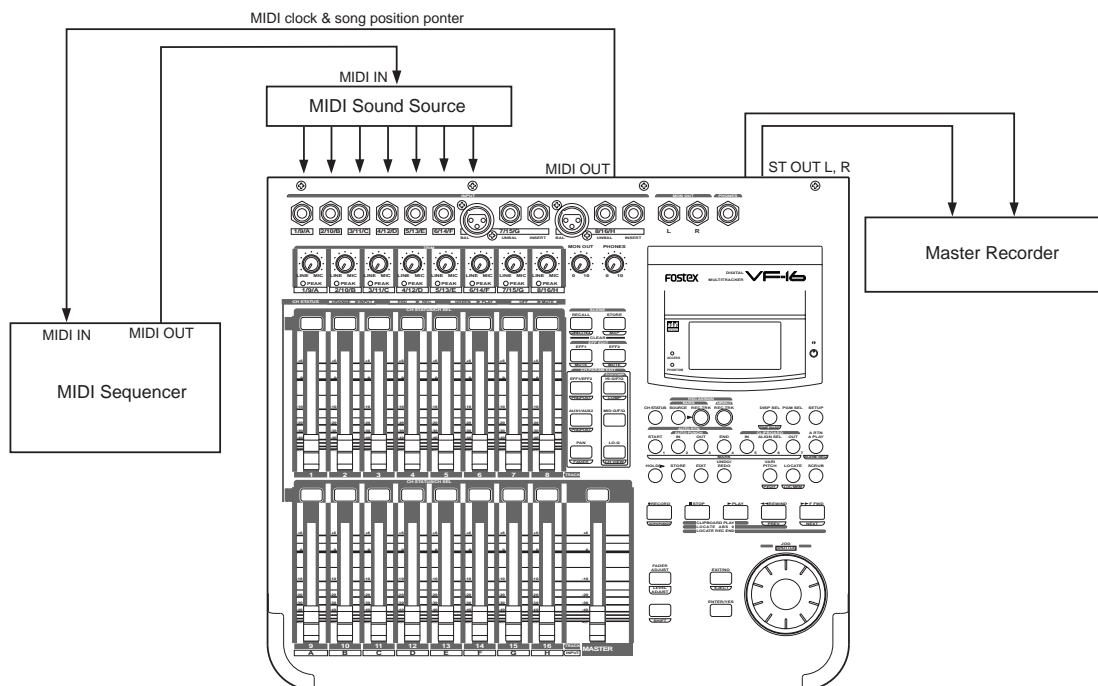

Connecting external equipment

1. Connect the VF-16 MIDI OUT to MIDI IN of the MIDI sequencer.
2. Set the MIDI sequencer for "external sync mode (EXTERNAL SYNC) by MIDI clock."
Refer to the Owners Manual of the equipment in use for details.

Setup of the VF-16

1. Because the MIDI clock and song position pointer will be output from the VF-16, set the SETUP mode "MIDI sync signal output setting" to "CLK."
Refer to page "103", SETUP mode "MIDI sync signal output setting" for correct operating procedures.
2. The meter in the desired bar can be set by "Time signature setting" of the SETUP mode.
Refer to page "99", SETUP mode "Time Signature Setting" for operating procedure.
3. Tempo in the desired bar can be set by "Tempo setting" of the SETUP mode.
Refer to page "101", SETUP mode "Tempo Setting" for operating procedure.
4. Set the SETUP mode "Metronome setting" to "On" if click sound is to be output according to the setup tempo map.
Refer to page "102", SETUP mode "Metronome setting" for operating procedure.

5. Press the [DISP SEL] key while holding down the [SHIFT] key, and then change the time base display to BAR/BEAT/CLK.

Confirming the MIDI clock sync

During recording and at playback following the recording, the time base (BAR/BEAT/CLK) is displayed in accordance to the setup tempo map, and the MIDI clock and song position pointer is also output.

Confirm that the travel position (BAR/BEAT/CLK) of the VF-16 and the travel position of the synchronized MIDI sequencer are matched.

If correct sync cannot be obtained, re-check the connections/ cables and setting of both equipment.

<Note>
In the VF-16, the "ABS 0" position is set at "-002BAR/1BEAT/00CLK." This setting is made in consideration of the time required (it will not sync immediately) for the MIDI sequencer, etc. to enter into sync. As a result, if the VF-16 is played back from ABS 0 (LOCATE ABS 0), sync will be completed by the time it reaches the first bar, and will thus synchronize from head of the tune.

Execution of recording

Various ways of recording can be conducted while synchronizing the VF-16 and the MIDI sequencer with the MIDI clock.

MTC sync/MIDI machine control system

The following will explain synchronization by the MTC (MIDI time code) output and the computer controlling system using MMC (MIDI machine control). In this system, the VF-16 will be the master and the computer (with sequence software) will be the slave. The VF-16 will attach any desired offset (time difference) against ABS time (absolute time) and output it as MTC in any desired frame rate. It can also carry out the proper operation upon receiving an MMC from outside. In this case, because the VF-16 can setup a DEVICE ID number by the SETUP mode "MIDI Device ID Setting" menu, a multiple number of the VF-16's can be separately controlled by changing the DEVICE ID numbers in the transmitted message from the computer.

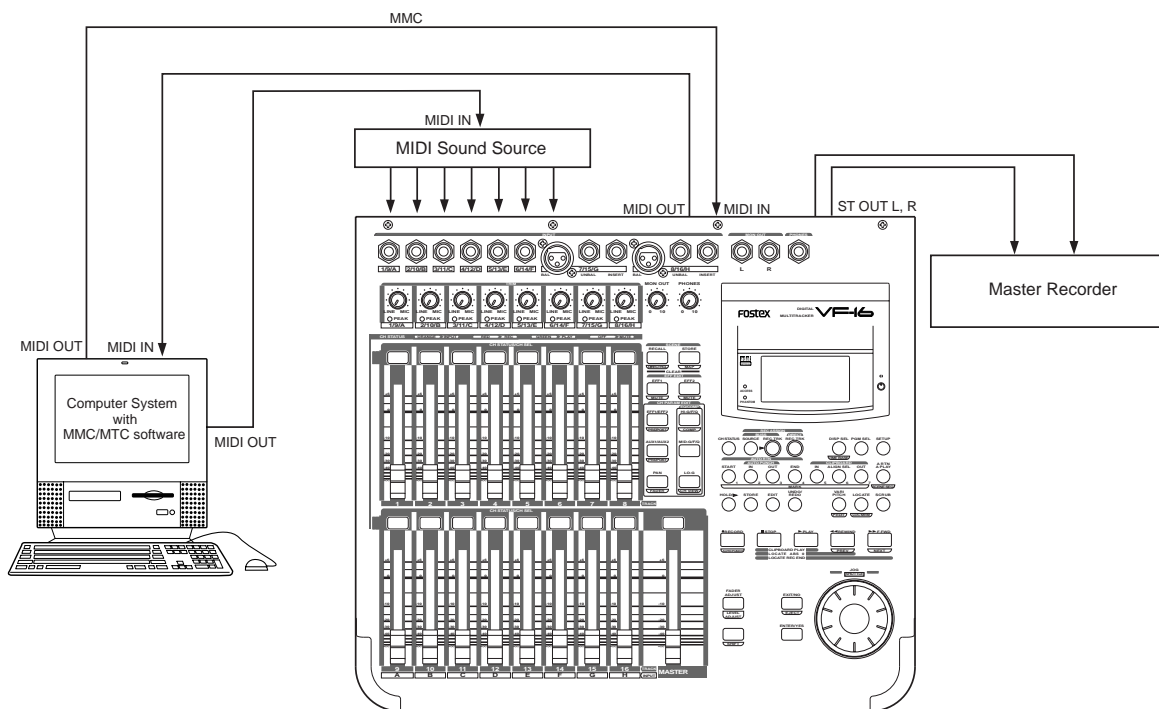

Connecting to external equipment

1. Connect the VF-16 MIDI IN/OUT to the computer (with MIDI interface) MIDI IN/OUT.
MMC/MTC complied sequence software is activated in the computer.

Setup of external equipment

1. Setup the following in the sequence software.
 - * Set to MTC external sync mode (EXTERNAL SYNC).
 - * Set for output of MMC.
 - * Set to the desired MTC read out frame rate.
 - * Set start time of the tune (which MTC time is to be the first bar). Refer to precaution in regards to MTC offset, farther on.

For details, refer to Owners Manual of the external equipment.

Setup of the VF-16

1. Because MTC will be output from the VF-16, set to "MTC" the SETUP mode "MIDI sync signal output setting."
Refer to page "103", SETUP mode "MIDI sync signal output setting" for operating procedure.
2. Set a random offset time by the SETUP mode "MTC offset time setting."
Refer to page "104", SETUP mode "MTC offset time setting" for operating procedure.
3. In the SETUP mode "MTC offset mode setting," whether the MTC offset time setup in Step 2 should be output (ABS) at the ABS 00m 00s 00f 00sf position or at the 001BAR 1BEAT 00CLK (bar, signature) must be selected.
Refer to page "105", SETUP mode "MTC offset mode setting" for operating procedure.
4. Setup to the same frame rate as that setup by the sequence software by "MTC Frame rate setting" of the SETUP mode.
Refer to page "104", SETUP mode "MTC Frame rate setting" for operating procedure and details.
5. Set to the same figure as the sequence software MMC device number by the SETUP mode "MIDI device ID setting."
When the sequence software transmits by "7F," it means "ALL DEVICE" and therefore, it need not be setup.
Refer to page "109", SETUP mode "MIDI device ID setting" for operating procedure and details.
6. Press the [DISP SEL] key while holding down the [SHIFT] key to show time base in the MTC display.

<Notes on MTC related setups>

By "MTC offset time setting" and "MTC offset mode setting," at what position (ABS 0 or 001BAR/1BEAT/00CLK) should the setup MTC (MTC offset time) is to be output is set. When setting the start time of the tune in the sequence software by these setups, be careful of the following points.

** Offset mode: For ABS*

If playback is started from ABS 0, since MTC will be output starting from the MTC offset time that has been set, the start time of the tune set by the sequence software must be set about 3 seconds later from the MTC offset time that was setup. This will provide time because the sequence software cannot sync immediately after MTC is output. For example, if the initial setting of 00h 59m 57s 00f 00sf" is used, set the start time of the tune to "01h 00m 00s 00f."

If playback is thus started from ABS 0 (LOCATE ABS 0), sync will be obtained by the time it reaches the first bar and therefore it can be made to sync from the head of the tune.

** Offset mode: For BAR*

As mentioned before, because the "ABS 0" position is set at the "002BAR/1BEAT/00CLK" position, the setup MTC offset time can be set to the head of the tune without taking into account the time until reaching sync, as mentioned above. The length of the time two bars beforehand will change in accordance to the first bar setting for "signature" and "tempo." For example, it will be long if the tempo is set slow. This mode can be effectively applied when using the MIDI clock and MTC in parallel, and when using MTC for the sync signal while controlling the recorder with time base BAR/BEAT/CLK.

Confirming MTC sync/MMC

1. During recording and at playback after recording, time base MTC is displayed according to the setting and MTC is output at the same time.
Check that the VF-16 traveling position (MTC) and the traveling position of the sequence software in sync are matched.
2. Send MMC commands such as PLAY, STOP and LOCATE from the sequence software to see that the VF-16 will be properly controlled.
When a correct MIDI command (MMC or FEX) is received, "MIDI" in the display will be lit for about 40msec.
There is no setting in the VF-16 to receive MMC or FEX but it will operate if a correct MIDI signal is input.

If sync and control cannot be done correctly, re-check connections/cables and the setting of both equipment.

Execution of recording

Carry out various recordings while synchronizing the VF-16 and a MIDI sequencer with the MIDI clock.

External MIDI equipment sync system by the slave mode

Up to this point, synchronization with external MIDI equipment has been explained with the VF-16 as the master and MIDI equipment as the slave but depending on the slave mode setting, the MIDI equipment can be set as the master and the VF-16 as the slave.

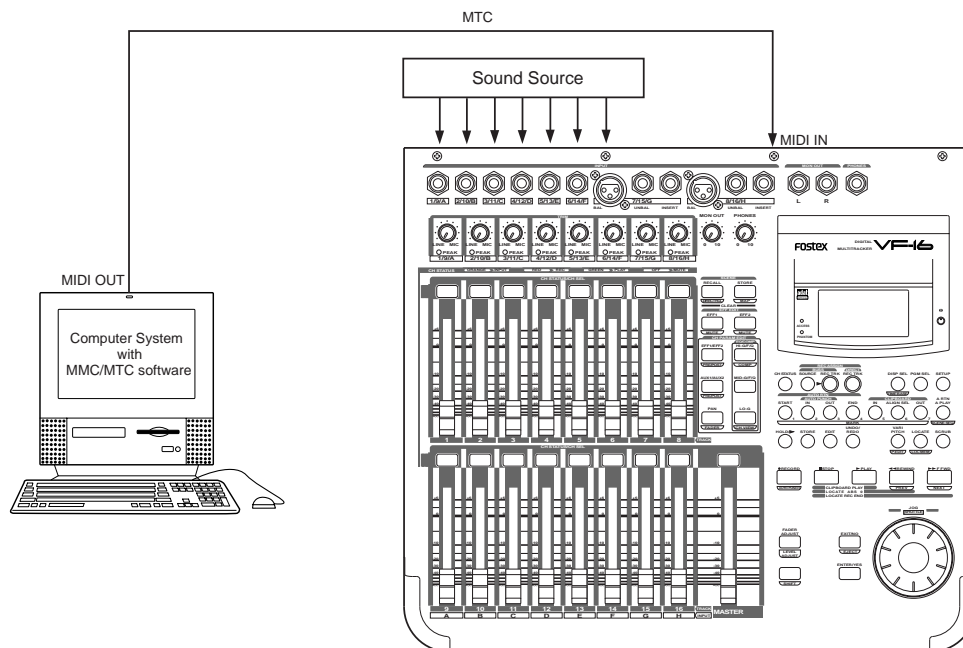

Connection to external equipment

1. Connect MIDI OUT of the computer (with MIDI interface) with MIDI IN of the VF-16.
The computer sequence software complying to MMC/MTC must be activated.

Setup of external equipment

1. Sequence software is setup as follows.
 - * Set for output of MTC.
 - * Set frame rate of the MTC to be output.
 - * Confirm start time of the tune.
 Refer to Owners Manual of the respective equipment for details.

Setup of the VF-16

1. Set to same frame rate as the sequence software by the SETUP mode "MTC Frame rate setting."
Refer to page "104", SETUP mode "MTC Frame rate setting" for operating procedure and details.
2. Set to the desired mode by the SETUP mode "MTC offset mode setting."
Refer to page "105", SETUP mode "MTC offset mode setting" for operating procedure and details.
3. A random offset time can be set by the SETUP mode "MTC offset time setting."
Refer to page "104", SETUP mode "MTC offset time setting" for operating procedure and details.
4. Set slave mode to "On" by the SETUP mode "Slave mode setting."
Refer to page "105", SETUP mode "Slave mode setting" for operating procedure and details.

5. Set slave type to "Vari" by the SETUP mode "Slave type setting."
Refer to page "106", SETUP mode "Slave type setting" for operating procedure and details.
6. Press the [DISP SEL] key while holding down the [SHIFT] key, to change the time base display to MTC.

<Precautions at MTC related setups>

The position (ABS 0 or 001BAR/1BEAT/00CLK) when the setup MTC (MTC offset time) should be output was setup by the "MTC offset time setting" and "MTC offset mode setting." In accordance to start time of the tune set by the sequence software, setup as explained below.

Offset mode: For ABS

Set the MTC offset time about three seconds prior to the start time of the tune set by the sequence software. Because the recorder cannot immediately chase lock after input of MTC, in order to sync the unit from head of the tune, set the preroll using the sequence software, and playback from before the actual head of the tune to allow the recorder to enter into sync by the time it arrives at the head of the tune.

Offset mode: For BAR/BEAT

The MTC offset time can be set to the same time as the start time of the tune set by the sequence software. Because the "ABS 0" position is set at the "0002BAR/1BEAT/00CLK" position in the unit, as mentioned before, the preceding time required for sync is already set. The preceding time of two bar lengths could change in length depending on the first bar's "signature setting" and "tempo setting" mentioned before. For example, it will be longer if the tempo is slowed down.

Confirming chase lock

1. When the sequence software is played, "CHASE" and "MTC" in the display will be light and the chase lock will be completed.
Check that the MTC output by the sequence software and MTC time displayed in the VF-16 are the same.
2. When the sequence software stops, MTC will be interrupted and the VF-16 will also stop.
"CHASE" in the display will change from lit to blinking.
3. During FF/REW of the sequence software, the VF-16 will remain stopped but upon starting to record, the VF-16 will immediately chase lock.
Should it not be possible to chase lock, re-check connections / cables and all settings.

<Note>

Normally, when "Setup of slave type" is set to "Vari," the VF-16 will be constantly controlled by vari-pitch and follow the MTC, which is the master.
However, if the digital input is set to "SPDIF" or "adat" via the SETUP mode "Setup of digital input," it will be in "Word clock external sync operation" by the digital signal (S/P DIF or adat) that is input.
Therefore, it must be noted that when "Setup of digital input" is executed, even though "Setup of slave type" is set to "Vari," it will not follow by application of vari-pitch and upon completion of lock, it will change to external sync operation by the digital input signal.

<One Point Advice>

Sync signal "Vari" of the "Slave mode setting" menu:
When the VF-16 is made to chase lock by MTC only, variable pitch will be constantly applied by external MTC. If a digital signal is output to an external digital equipment from the VF-16, it will not be able to follow the speed difference (MTC speed difference of the master) of the VF-16 and the external digital equipment, in some cases, may not be able to input a continuous digital signal.

As a counter measure, the sync signal should be set to "Free" by the "Slave mode setting" menu. Using this setting, the VF-16 will enter self operation by the internal clock, after completion of chase lock, and it will be possible to supply a stable digital signal to the external equipment.

Under this setting, when MTC drift between the master recorder and slave recorder exceeds 10 frames, the VF-16 will assume that chase lock has been disengaged and the slave recorder will carry out position matching again with the master unit (re-chase operation). During the re-chase operation, sound output will be muted and the digital signal will also be interrupted. If it is within 10 frames, the slave recorder will continue to run while admitting this drift.

Execution of recording

1. Carry out various recordings while the recorder is chase locked to the sequence software.

<Note>

Chase lock of the VF-16 by MTC only is permissible when speed difference of the MTC from the master is within +/- 5.6%. Against the MTC within this range, variable pitch will be constantly applied internally for chasing. Chase lock, however, will not function against MTC at a speed difference outside this range. Also, when the master speed difference is large, it is advised to let the VF-16 learn the master speed by entering PLAY prior to recording. By doing so, it will be lock faster from the second and later sessions.

Chapter 6 Save/Load of song data

You can save or load the desired song data (including audio and various setup data) of the current program to a DAT or adat recorder, as well as a SCSI backup device.

This function allows you to save finished or unfinished song data to a digital recorder such as a DAT and adat or a SCSI backup device, and load the data later.

*****About song data*****

There are three methods of saving/loading song data depending on the digital signals used to handle the data, which are S/PDIF digital, adat digital and SCSI. The format and time required for the save/load operations are different between each method.

•Using the S/PDIF digital signal (you can save/load data for each program individually.):

Following to five seconds of the pilot signal (shown in gray in the diagram below), the song data is output to a DAT. The audio data is divided into data blocks of track pairs (shown in black in the diagram below) and transferred. To save data for Real tracks 1 through 16, 8 two-track data are transferred. To save all tracks including the Additional tracks in addition to the Real tracks, 12 two-track data are transferred. Therefore, it will take about 8 times as much as the recorded time of a program (from ABS 0 to REC END) to save the Real tracks 1 through 16 of the program, while it will take about 12 times to save all the data including the Additional tracks. When loading song data from the DAT to the VF-16 via the S/PDIF digital signal, data is transferred with two-track data blocks, as with the same way as saving data from the VF-16 to the DAT. (See also <Notes> on the next page.)

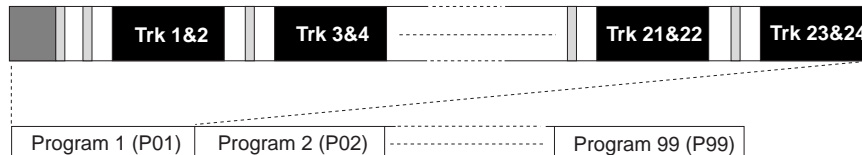

•Using the adat digital signal (you can save/load data for each program individually.):

After the pilot signal (shown in gray in the diagram below) which takes approximately 5 seconds, the song data is output to an adat machine. The audio data is divided into data blocks of 8 tracks (shown in black in the diagram below) and transferred. To save Real tracks 1 through 16, two 8-track data are transferred. To save all tracks including the Additional tracks in addition to the Real tracks, three 8-track data are transferred. Therefore, it will take about twice as much as the recorded time of a program (from ABS 0 to REC END) to save the Real tracks 1 through 16 of the program, while it will take about 3 times to save all the data including the Additional tracks. When loading song data from an adat machine to the VF-16 via the adat digital signal, data is also transferred with eight-track data blocks, as with the same way as saving data from the VF-16 to an adat machine. (See also <Notes> on the next page.)

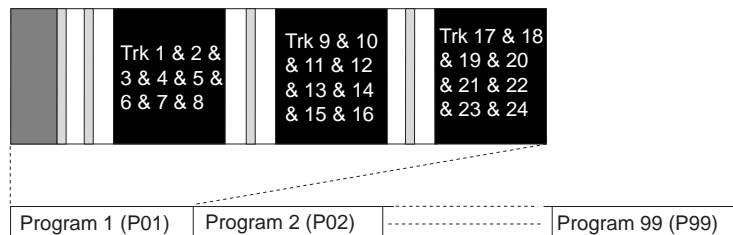

•Using a SCSI disk (you can save/load data for each program individually.):

When using a SCSI disk, all audio data including both the Real and Additional tracks (shown in black in the diagram below) is transferred simultaneously. Therefore, you can save or load a program much faster than using the S/PDIF or adat signal. Note that no pilot tone or beep sound is recorded when saving data to a SCSI disk. If song data to be saved requires more space than the available disk space, you can save the data to more than one disk (up to 99 disks). You can also save/load data to/from a DOS formatted disk by the WAV file format. In the save/load operation using the WAV file, you can specify a track to be saved or loaded, as well as all tracks.

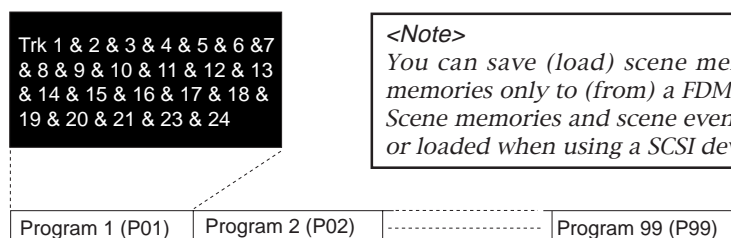

<Note>
 You can save (load) scene memories and scene event memories only to (from) a FDMS-3 formatted SCSI disk. Scene memories and scene event memories can be saved or loaded when using a SCSI device (except WAV).

<Items that can be saved or loaded as song data>

- Memory data:

Data for CLIPBOARD IN/OUT, AUTO RTN START/END, AUTO PUNCH IN/OUT.
Locate data (for Locate No. 00 through 99, only available with save/load using SCSI)

- Timebase:

ABS, MTC or BAR/BEAT/CLK

- SETUP mode:

Bar/beat setting, tempo setting, metronome on/off, preroll time, MIDI synchronization output signal setting, MTC offset time, MTC offset mode, REC protect setting, slave mode on/off, slave type setting

<Items that cannot be saved or loaded as song data>

- On/off settings for Auto play mode and Auto return mode

- Varipitch on/off and pitch data

- SETUP mode:

DIGITAL IN and DIGITAL OUT settings, bar/beat resolution on/off and device ID

<Notes for DAT and adat machines to be used>

The VF-16 song data only can be saved to or loaded from a digital machine that can record 16 bit, 44.1 kHz linear digital data with S/PDIF or adat format (such as DAT and adat machines).

<Notes for saving data using the S/PDIF or adat digital signal>

When saving all data including both real and Additional track data using the S/PDIF or adat digital signal, note the following.

Only the data recorded within the time duration between ABS 0 and REC END of the Real tracks is saved. Therefore, if the recorded time of Additional tracks is longer than the Real tracks, only the Additional track data within the time duration between ABS 0 and REC END of the Real tracks is saved.

In the example shown on the right, the Additional tracks have data from "00m 00s" to "10m 00s", while the Real tracks have data from "00m 00s" to "07m 00s".

If you are going to save all tracks, the Additional track data from "00m 00s" to "07m 00s" will be saved but the rest will not be saved.

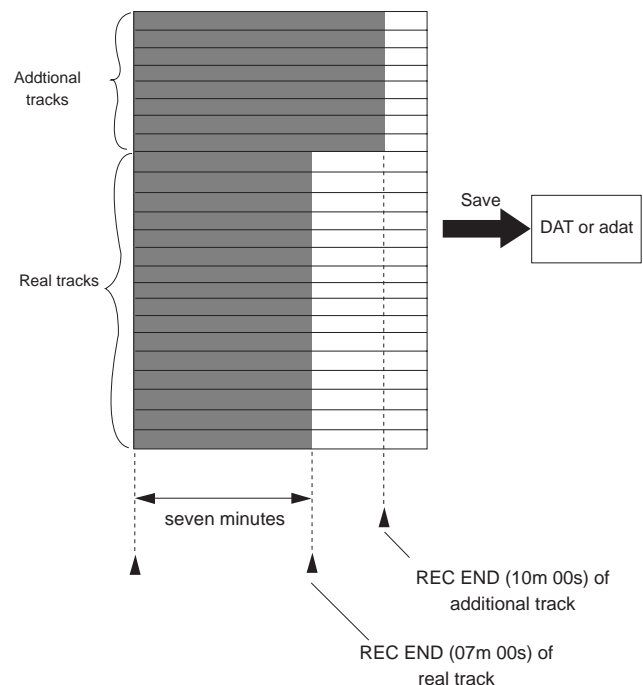

Saving data using the S/PDIF or adat digital signal

You can save data using the S/PDIF or adat digital signal via the DIGITAL/DATA OUT jack.

*Use an external device that supports 44.1 kHz sampling frequency (the same as the VF-16).

Connecting to an external device

Connect the DIGITAL/DATA OUT jack to the digital input jack of the external digital device (DAT or adat etc.).

<Note>
The DIGITAL/DATA OUT jack accommodates either the S/PDIF (optical) or adat digital signal selected. Though the S/PDIF (optical) and adat digital signal use the same connector shape, the signal formats are different.

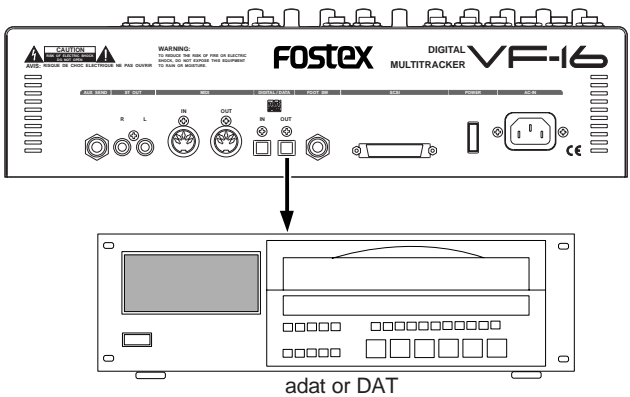

- When using the S/PDIF signal, if your DAT only provide the coaxial (RCA) digital input jack and does not provide the optical jack, use the optional COP-1/96kHz (optical/coaxial converter).
- Do not connect digital signals for both directions between the VF-16 and the external device (i.e. the digital output of the VF-16 to the digital input of the external device and the digital output of the external device to the digital input of the VF-16), which may form a digital loop and cause feedback.

Setting the external device

1. Set the sampling frequency to 44.1 kHz (the same as the VF-16).
2. Set the input source to "digital input" to accept the signal from the VF-16.
Some machine also needs to select the clock reference to "external" when setting the input source to "digital input". See the operation manual of the machine for the detailed information.

<Note>
If you cannot hear the input signal or you hear digital noise when monitoring the source signal of the external digital device, check the connections, cables and settings of both the VF-16 and the external device.

*See the operation manual of the external device for the detailed information.

Saving data

You can save data via the "Save PGM" menu in the SETUP mode.

<Details about "Save PGM" menu>

- Output signal options: adat, S/PDIF and SCSI
- Program options:
P01 to P99 (an individual Program)
- Track options:
* When using S/PDIF or adat:
Tracks 1-8, Tracks 1-16, Tracks 1-24, Tracks 9-16, Tracks 9-24 or Tracks 17-24.
* When using a SCSI disk:
All tracks (1-24) is selected automatically. (You can select tracks individually when saving by the WAV file format).

1. Press the [SETUP] key to enter the Setup mode.
The display shows the screen for selecting the Setup menu.
2. Use the [JOG] dial to select "Save PGM" and press the [ENTER/YES] key.
The display shows the screen for selecting the device to which the data is saved. "SCSI" flashes.

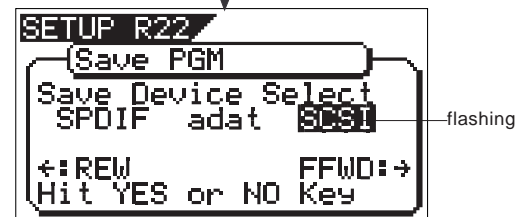
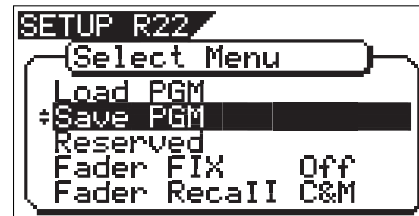

3. Use the [REWIND] or [F FWD] key to select "SPDIF" (or "adat") and press the [ENTER/YES] key.
The display shows the screen for selecting the program to be saved. The program number currently selected flashes, while the data size of the program is shown. While a program number is flashing, you can select the desired program to be saved.

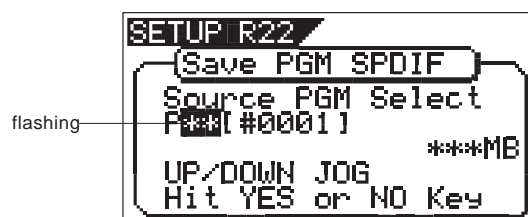

If you save data using the adat digital signal, select "adat". If you save data using the S/PDIF digital signal, select "SPDIF". If you save/load data using the SCSI (described later), select "SCSI".

4. Use the [JOG] dial to select the program to be saved and press the [ENTER/YES] key.

The display shows the "Save Length" screen. Initially, the recorded time length of the selected program (ABS 00 to REC END) is shown as the time length of data saving. Normally you do not need to edit the length but you may edit it to the desired value if needed.

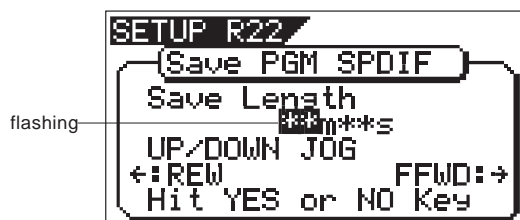

For example, if the actual recorded time is 9 min. 00 sec., you can make the length of the data to be saved shorter or longer than 9 min. 00 sec., as long as the length does not exceed 59 min.59 sec. The initially displayed value here is the length of the Real track, therefore, as noted earlier, you may edit the value to match the length of the Additional track if it is longer.

To edit the save length

Press the [REWIND] or [F FWD] key to move the flashing field between "minutes" and "seconds". Use the [JOG] dial to set the value for the flashing field.

5. Press the [ENTER/YES] key. The display shows the screen for selecting tracks to be saved.

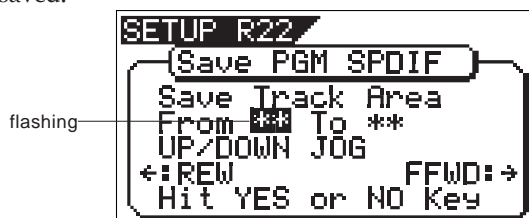

6. Select tracks to be saved. Press the [REWIND] or [F FWD] key to move the flashing field between "From" and "To". Use the [JOG] dial to set the track number for the flashing field. For the "From" field, you can select from 1, 9 and 17. For the "To" field, you can select from 8, 16 and 24. For example, if you select "From 1 to 24", data for all tracks (1 to 24) will be saved.

<Note>

When you save tracks including Additional tracks, read <Notes for saving data using the S/PDIF or adat digital signal> on page 79 before executing the save operation.

7. After selecting tracks, press the [ENTER/YES] key again. The display shows "Rec Start Recorder!" together with the program and tracks to be saved, and "Sure?" flashes. This means "are you sure to start saving data to recorder?".

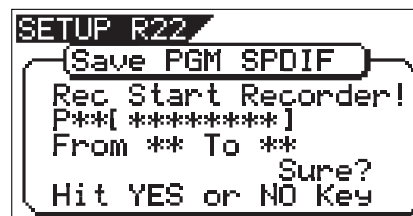

8. After checking any preparations on the external digital recorder are made, start it recording. It may be a good idea to put a START-ID (for DAT) or set a locate memory at the starting position so that you can easily find the position when you load the data later.
9. Press the [ENTER/YES] key right after the external machine starts recording. The display shows something like the one below. After a few seconds, the unit starts saving the data and "Wait time" starts counting down.

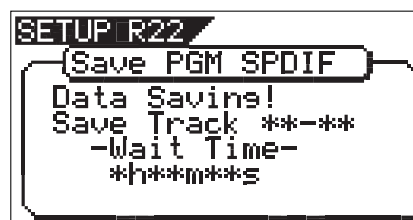

For the first several seconds, the VF-16 transmits the pilot signal that will a reference for locating the tape position during the load operation, and the actual data saving starts from the position at which "Wait time" starts counting down. Using the S/PDIF signal, data is saved in 2-track unit. Using the adat signal, data is saved in 8-track unit. When the data saving is completed, "Completed!" appears on the screen and the VF-16 stops.

<Note>

If you interrupts saving before completing, the saved data is invalid.

10. Stop the external recorder machine.
11. Press the [EXIT/NO] key (or the [STOP] key) repeatedly until exiting the Setup mode.

To cancel each operation or to return to the previous screen before pressing the [ENTER/YES] key, press the [EXIT/NO] key (or the [STOP] key). Each press of the key returns to the previous screen and finally exits the Setup mode.

Loading data using the S/PDIF or adat digital signal

You can load data using the S/PDIF or adat digital signal via the DIGITAL/DATA IN jack.

**Use an external device that supports 44.1 kHz sampling frequency (the same as the VF-16)*

Connecting to an external device

Connect the DIGITAL/DATA IN jack to the digital output jack of the external digital device.

<Notes>

- The DIGITAL/DATA OUT jack accommodates either the S/PDIF (optical) or adat digital signal selected. Though the S/PDIF (optical) and adat digital signal use the same connector shape, the signal formats are different.
- Do not do anything, such as unplug the optical cable, that interrupts the digital signal until the loading operation is completed. Otherwise, the unit may generate a noise which damages an external device.

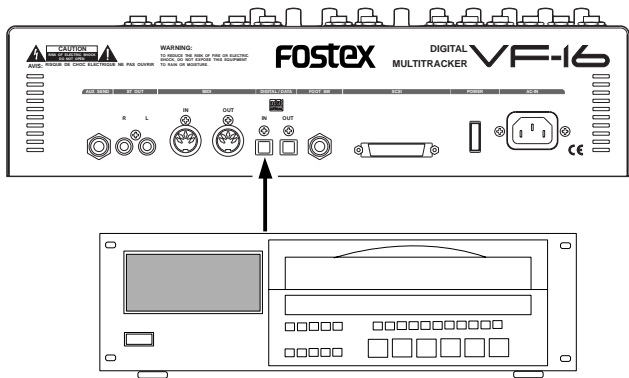

- When using the S/PDIF signal, if your DAT only provide the coaxial (RCA) digital input jack and does not provide the optical jack, use the optional COP-1/96kHz (optical/coaxial converter).
- Do not connect digital signals for both directions between the VF-16 and the external device (i.e. the digital output of the VF-16 to the digital input of the external device and the digital output of the external device to the digital input of the VF-16), which may form a digital loop and cause feedback.

Setting the external device

1. Make preparations of the external device for outputting the digital signal.
2. Locate the beginning of the pilot signal for the song data.

**See the operation manual of the external device for the detailed information.*

Loading data

You can load data via the "Load PGM" menu in the SETUP mode.

<Details about "Load PGM" menu>

- Input signal options: adat, S/PDIF and SCSI
- Program options: P01 to P99 (an individual Program)
- Track options:
 - * When using S/PDIF or adat: Tracks 1-8, Tracks 1-16, Tracks 1-24, Tracks 9-16, Tracks 9-24 or Tracks 17-24.
 - * When using a SCSI disk: All tracks (1-24) is selected automatically. (You can select tracks individually when loading a WAV file).

1. Press the [SETUP] key to enter the Setup mode. The display shows the screen for selecting the Setup menu.
2. Use the [JOG] dial to select "Load PGM" and press the [ENTER/YES] key. The display shows the screen for selecting the device from which the data is loaded. "SCSI" flashes.

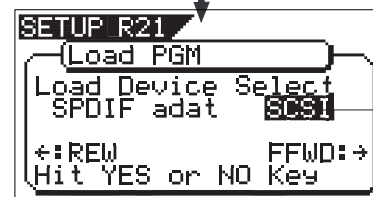
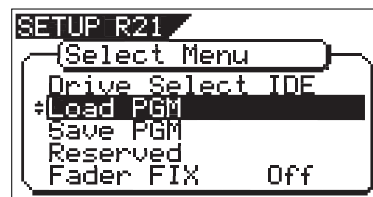

3. Use the [REWIND] or [F FWD] key to select "SPDIF" (or "adat") and press the [ENTER/YES] key. The display shows the screen for selecting a load destination program to which data is loaded. A program number currently selected flashes, followed by its program name. The data size of the current program is also shown. When a program number is flashing, you can select the desired load destination program.

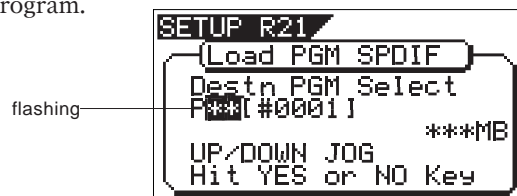

You can select a load destination program from existing programs on the current drive as well as "New PGM". When selecting "New PGM", a new program is created.

* If you load data to a program in which data is already recorded, the newly loaded data overwrites the current data track by track. Consequently, on each overwritten track, the loaded data becomes valid while the current data is erased.

4. Use the [JOG] dial to select the program to which data is loaded and press the [ENTER/YES] key.

The display shows the screen for selecting tracks to be loaded.

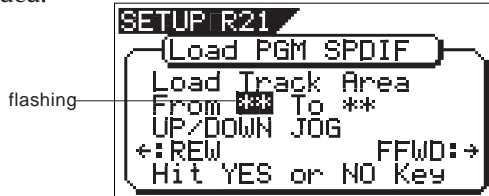

5. Select tracks to be loaded. Press the [REWIND] or [F FWD] key to move the flashing field between "From" and "To". Use the [JOG] dial to set the track number for the flashing field. For the "From" field, you can select from 1, 9 and 17. For the "To" field, you can select from 8, 16 and 24. For example, if you select "From 1 to 24", data for all tracks (1 to 24) will be loaded.

6. After selecting tracks, press the [ENTER/YES] key again.

The display shows something like the one below. A load destination program (existing or new program) to which the data is loaded and tracks to be loaded are shown, while "Sure?" flashes.

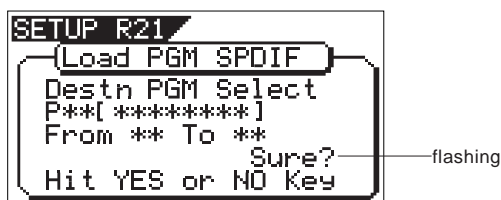

<Note>

In the above step, if the VF-16 does not lock to the digital signal from the external digital device, the following warning message appears on the display.

This indicates that the VF-16 does not receive a correct digital signal (S/PDIF or adat signal). So check the cable connection and the digital output settings of the external digital device.

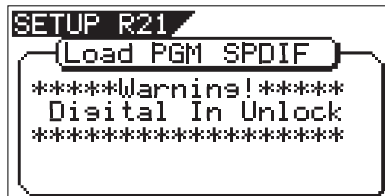

7. When the VF-16 is locking to the digital input signal, press the [ENTER/YES] key.

The display shows "Play Start Player!"

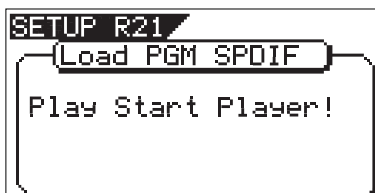

8. Start playback of the player.

After reading the pilot signal recorded when saving the data, the data starts loading automatically.

When starts loading, the display shows something like the one below, in which "Wait time" starts counting down.

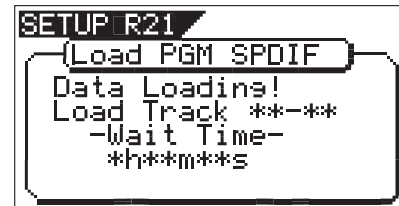

Using the S/PDIF signal, data is loaded in 2-track unit. While loading, the indicators on [CH STATUS/CH SEL] keys for channels 1 and 2 flash, while the input levels are displayed by level meters 1 and 2.

Using the adat signal, data is loaded in 8-track unit. While loading, the indicators on [CH STATUS/CH SEL] keys for channels 1 through 8 flash, while the input levels are displayed by level meters 1 and 8.

When the data loading is completed, "Completed!" appears on the screen.

<Note>

If you quit loading before completing, the loaded data is invalid.

9. Stop the external DAT (or adat) machine.

10. Press the [EXIT/NO] key (or the [STOP] key) repeatedly until exiting the Setup mode.

To cancel each operation or to return to the previous screen before pressing the [ENTER/YES] key, press the [EXIT/NO] key (or the STOP key). Each press of the key returns to the previous screen and finally exits the Setup mode.

Saving/loading data using SCSI

You can save/load song data using a SCSI backup disk.

Normally a backup SCSI disk should be formatted by the backup format (for backup use only). You can also save data to or load data from a WEV file on a SCSI disk formatted by the DOS format (for computer use). Since song data written in a WAV file can be read by a computer, as well as can be loaded to the VF-16, you can use the data with a music software.

<Note>

You can save (load) scene memories and scene event memories only to (from) a FDMS-3 formatted SCSI disk. Scene memories and scene event memories can be saved or loaded when using a SCSI device (except WAV).

Connecting to an external device

Connect the unit's SCSI connector (half pitch 25-pin type for Macintosh) to an external SCSI device. Before connecting to a SCSI device, read the following notes carefully.

<Notes>

- Make connection with the power turned off.
- You can connect only one SCSI device via the SCSI connector of the VF-16. When connecting a external SCSI device to the unit, insert a SCSI terminator to the other (unused) SCSI connector of the device. Or, if the device provides a switch that switches the SCSI termination, set it to ON.
- There is no limitation for the ID number of the backup SCSI device. The unit automatically recognizes the device as a backup SCSI device.
- You must format the disk used with the backup SCSI device after connecting the device. See "Formatting a backup disk" below for the detail information.

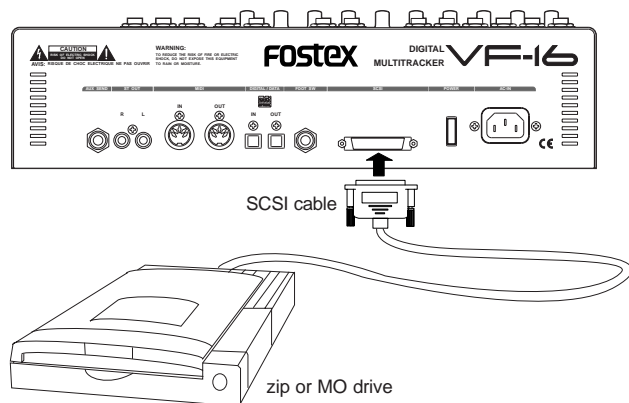

Formatting a backup disk

You can use an unformatted disk or disk currently used for a computer, etc.

When formatting a disk currently used for a computer, make sure that you do not need the data recorded on the disk. Once you start formatting, you cannot stop or cancel formatting. The following procedure assumes that a removable disk is used.

<Notes>

- A write-protected disk cannot be used. Release the protection before using.
- The disk formatted by the VF-16 can be used for saving/loading by the FDMS-3. The VF-16 cannot DOS-format a disk for saving/loading by a WEV file. So, to DOS-format a disk, use a personal computer, etc.

1. After connecting a backup SCSI device to the VF-16, turn on the both machine.
2. Insert a backup disk into the SCSI device.
3. Press the [SETUP] key to enter the Setup mode. The display shows the screen for selecting the Setup menu.
4. Use the [JOG] dial to select "Disk Format" and press the [ENTER/YES] key. The display shows the screen for selecting a drive. "IDE" (E-IDE hard disk) flashes.

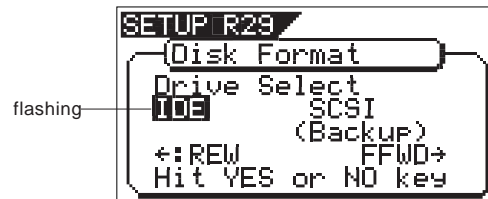

5. Use the [F FWD] key to make "SCSI" flash and press the [ENTER/YES] key. The display shows the name of the SCSI device connected, and "Sure?" flashes.

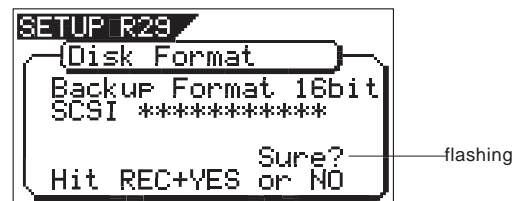

6. While holding down the [RECORD] key, press the [ENTER/YES] key. The unit starts formatting the backup disk. When formatting is completed, "Completed!" appears on the screen.
7. Press the [EXIT/NO] key (or the [STOP] key) repeatedly until exiting the Setup mode.

A backup SCSI disk is formatted and ready to be used for data saving/loading by the FDMS-3. If you continue to format another disk, remove the current disk and repeat the procedure above. To remove a disk, press the [EJECT] key on the SCSI device.

Saving data to a SCSI disk

You can save data via the "Save PGM" menu in the SETUP mode. When saving to a SCSI disk, you can save data for each specified program like saving to a DAT/adat.

<Details about "Save PGM" menu>

•Output signal options: adat, S/PDIF and SCSI

•Program options:

P01 to P99 (an individual Program)

•Track options:

* When using S/PDIF or adat:

Tracks 1-8, Tracks 1-16, Tracks 1-24, Tracks 9-16,
Tracks 9-24 or Tracks 17-24.

* When using a SCSI disk:

All tracks (1-24) is selected automatically. (You can select tracks individually when saving by the WAV file format).

<Note>

When saving a single program data to more than one removable disk, we suggest to put a number on each disk in the saving order so that you will easily know the order when loading the data later.

1. Press the [SETUP] key to enter the Setup mode. The display shows the screen for selecting the Setup menu.
2. Use the [JOG] dial to select "Save PGM" and press the [ENTER/YES] key. The display shows the screen for selecting the device to which the data is saved. "SCSI" flashes.

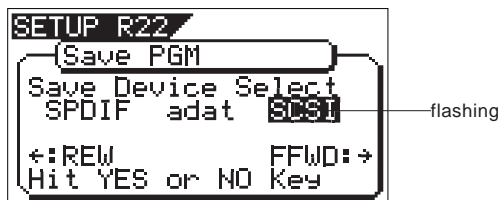

3. While "SCSI" is flashing, press the [ENTER/YES] key. The display shows the screen for selecting the backup mode (FDMS 3 or WAV). If a disk formatted by the FDMS-3 is set, "FDMS 3" flashes.

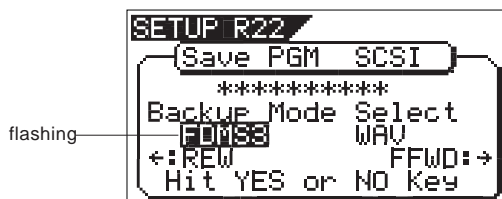

4. While "FDMS 3" is flashing, press the [ENTER/YES] key. The display shows the screen for selecting a program to be saved. The program number currently selected flashes, while the data size of the program is shown.

<Hint>

If you select the backup mode to "WAV" and press the [ENTER/YES] key while a disk formatted by the FDMS-3 is set, the display shows "Warning Illegal Disk!" and the disk is ejected.

5. Use the [JOG] dial to select a program to be saved. Depending on a program selected, the display shows as below.

- When selecting a vacant program (no data is recorded): "0MB" is shown.

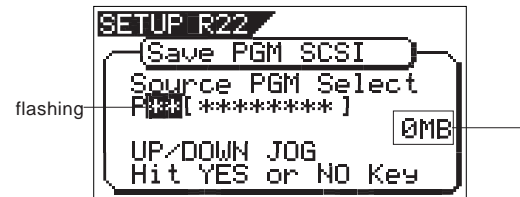

- When selecting a program that can be saved to a single backup disk: The example below shows "68 MB". This means the data size of the data is 68 MB and the data can be saved to a single disk.

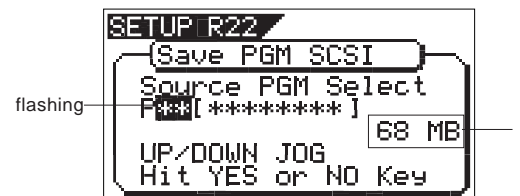

- When selecting a program that needs more than one backup disk for saving. The example below shows "2 Disks 130 MB". This means the data size of the data is 130 MB and you need two disks to save the data.

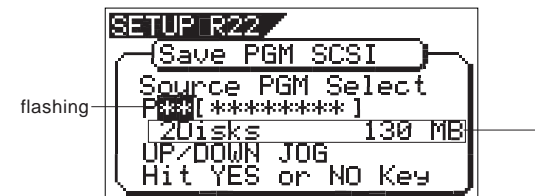

6. After selecting the program, press the [ENTER/YES] key. The display shows the difference screens depending on whether or not the program can be saved to a single disk, as below.

- When the program can be saved to a single disk: The display shows the screens for creating a new program on the backup disk (the program number "B01" is shown for the backup disk) and "Sure?" flashes.

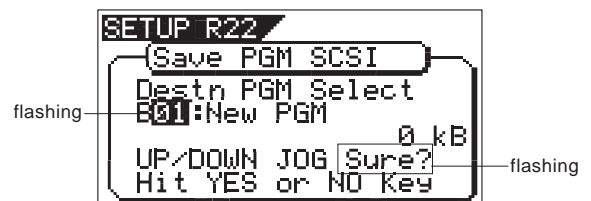

Pressing the [ENTER/YES] key in the above condition starts saving and the screens shown below appears.

<Hint>

While "B01: New PGM" is flashing, you can select "Eject" for the forced eject by using the [JOG] dial. When you remove the disk forcibly, select "Eject" and press the [ENTER/YES] key. The disk will be ejected and "Insert Disk" will flash on the display.

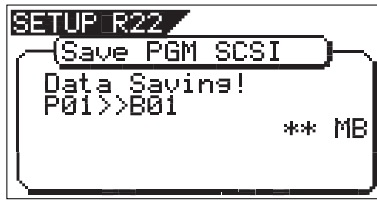

The screen above shows that the VF-16 is saving the song data of program 01 to B01 on the backup disk. The remaining data size shown on the screen counts down while the data save goes on. Wait for a while until the save operation is completed.

When the save operation is completed, the display changes to something like the one as shown below, while the VF-16 stops.

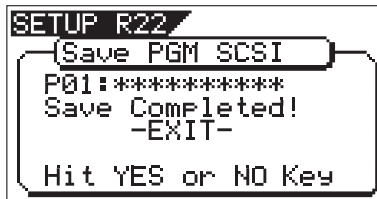

•When the program requires more than one disk for saving:
Pressing the [ENTER/YES] key immediately starts saving to the first disk and the "Data Saving" screen, same as described above, appears.

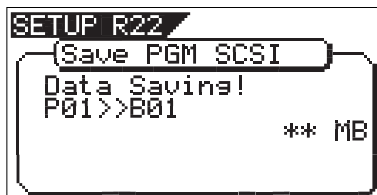

The first disk is ejected when it becomes full, and "Insert Disk2!" flashes on the screen. Inserting the second disk to the SCSI device automatically resumes saving. If more than two disks are required for saving, repeat the same procedure as above.

When the save operation to all disks is completed, "Completed!" appears on the display, while the VF-16 stops.

<Note>

You cannot abort the save operation before completed, unlike the save operation using the S/PDIF or adat signal. Especially during the save operation to more than one disk, if you happen to press the [EXIT/NO] key while removing or inserting a disk, you have to redo the save operation from the beginning using the first disk.

7. Press the [EXIT/NO] key (or the [STOP] key) repeatedly until exiting the Setup mode.

•To remove the disk from the SCSI drive after the save operation is completed, press the eject key on the SCSI drive.

<Hint>

The save operations described above (both for using a single disk and multiple disks) are assumed that backup disks used are newly formatted and have no recorded data. It will be ideal to prepare newly formatted "clean" disks before the save operation, however, there may be some cases where you have to use disks containing recorded data or unformatted disks. See the following notes for such a case.

- If you are going to save to an unformatted disk: The VF-16 recognizes that the disk is "unformatted" after executing steps 1 through 4 described above, and the following screen appears.

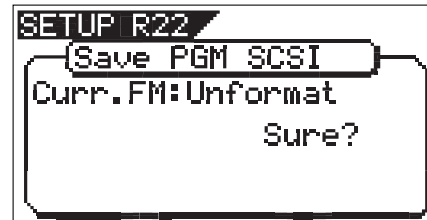

By pressing the [ENTER/YES] key while holding down the [RECORD] key, the disk is formatted and the display shows the screen for selecting the program to be saved, as described above.

- If you select a program to be saved to the backup disk which has saved data: After executing steps 1 through 6 described above, the display shows the screen for selecting the program to be saved. You can select from existing programs on the backup disk and "New PGM". If you select an existing program and execute the save operation, the new data overwrites the program (the existing data is erased). If you select "New PGM", the data is saved to a newly created program, while other existing programs are unchanged.

- If you are going to save data to "New PGM" but the disk does not have enough available space for the data: When you select "New PGM", the available disk space is shown. If you press the [ENTER/YES] key, "Disk Full!" is shown at the top of the screen and you cannot execute the save operation. In such a case, you may save data by overwriting an existing program. If you want to cancel the save operation, select "Eject" by using the [JOG] dial and then press the [ENTER/YES] key.

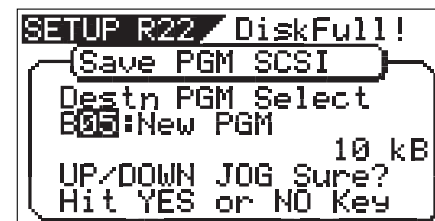

- If you are going to save data to a disk that is used as the current drive by another digital recorder: After executing steps 1 through 4 described above, "Wrong Disk!" is shown and then the screen for prompting to format the disk shown above appears. you may format the disk by pressing the [ENTER/YES] key while holding down the [RECORD] key, or cancel the save operation by selecting "Eject" and then pressing the [ENTER/YES] key.

- In the saving operation using more than one disk, if you use a disk in which save data is already recorded:

When carrying out step 6 above, an existing program number is shown. In this condition, by using the [JOG] dial, you can select "Eject", as well as existing programs.

To eject the disk, select "Eject" and press the [ENTER/YES] key.

If you save data to the disk, select any existing program and press the [ENTER/YES] key.

The display shows "Delete All" and "Sure?" (flashing) as below.



Press the [ENTER/YES] key while the above screen is shown.

All backup data recorded in the disk are erased and then the save operation starts.

Loading from a single SCSI disk

You can load data using the "Load PGM" menu in the SETUP mode. The following procedure shows how to load song data saved to a single SCSI disk. See the next section for loading data saved to more than one SCSI disk.

<Details about "Load PGM" menu>

- Input signal options:
adat, S/PDIF or SCSI
- Program options:
P01 to P99 (an individual Program)
- Track options:
* When using S/PDIF or adat:
Tracks 1-8, Tracks 1-16, Tracks 1-24, Tracks 9-16, Tracks 9-24 or Tracks 17-24.
* When using a SCSI disk:
All tracks (1-24) is selected automatically. (You can select tracks individually when loading a WAV file).

1. Press the [SETUP] key to enter the Setup mode.
The display shows the screen for selecting the Setup menu.
2. Use the [JOG] dial to select "Load PGM" and press the [ENTER/YES] key.
The display shows the screen for selecting the device from which the data is loaded. "SCSI" flashes.

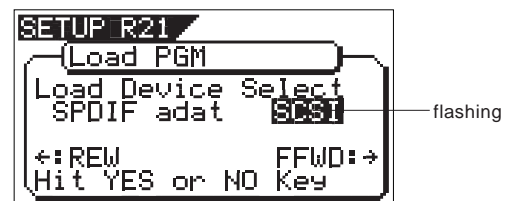

3. While "SCSI" is flashing, press the [ENTER/YES] key.
The display shows the screen for selecting the program to be loaded.
The backup number currently selected flashes, while the data size of the program is shown. While a backup number is flashing, you can select the desired program to be loaded. If a disk has more than one program saved, you can select the desired program by using the [JOG] dial.

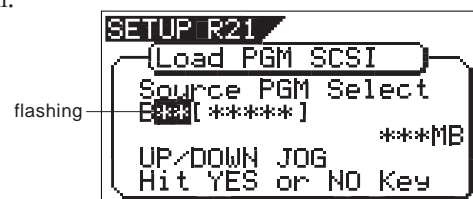

- You can also select "Eject" as well as programs to be loaded in the condition above.
To eject the disk, press the [ENTER/YES] key after selecting "Eject".

4. Use the [JOG] dial to select the program to be loaded and press the [ENTER/YES] key.
The display shows the screen for selecting the destination program to which data is loaded. In the default setting, "New PGM" is selected so that the data is loaded to a newly created program.

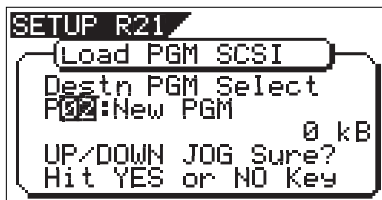

You can select any existing program available on the current drive by rotating the [JOG] dial besides "New PGM".

When selecting an existing program, the data size of the program is also shown.

When you load the data to any existing program, the backup data overwrites the existing data.

If you do not like to overwrite any track, select "New PGM".

<Note>

If the current drive disk (destination disk of loading data) does not have enough available space for accepting the loaded data, The display shows "Disk Full" and the returns to the screen shown when carrying out step 3.

- Use the [JOG] dial to select the load destination program and press the [ENTER/YES] key. The data load to the selected program starts. The following screen example shows that the "B01" data on the backup disk is now being loaded to "P02" on the current disk. As the data load goes on, the remaining data size shown on the screen counts down.

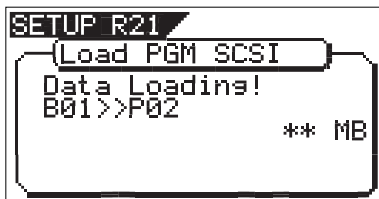

<Note>

You cannot abort the load operation before completed using SCSI, unlike the load operation using the S/PDIF or adat signal.

When the load operation is completed, "Completed!" appears, while the VF-16 stops.

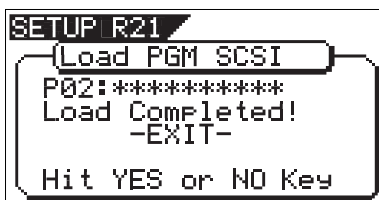

- Press the [EXIT/NO] key (or the [STOP] key) repeatedly until exiting the Setup mode.

Loading from more than one disk

The following procedure shows how to load song data saved to two SCSI disks.

- Insert the first disk (Disk-1) to the SCSI device.
- Carry out the same procedures as steps 1 through 3 described in the previous section "Loading from a single disk". The display shows the screen for selecting a program loaded.

If the program is saved over more than one disks, backup file number "B01" flashes, as well as the recorded data size is shown.

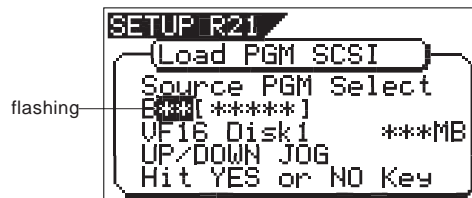

- By using the [JOG] dial in this step, you can select "Eject" as well as destination programs. To eject the disk, select "Eject" and press the [ENTER/YES] key.

<Note>

If Disk-2 (the second disk when saving) is inserted in mistake, the VF-16 automatically recognized that the wrong disk is set. The display shows "Wrong Disk", followed by "Illegal No!", and the disk is automatically ejected. Then, as the display shows "Insert Disk", insert Disk-1.

- Press the [ENTER/YES] key. The display shows the screen for selecting the destination program to which data is loaded. In the default setting, "New PGM" is selected so that the data is loaded to a newly created program.

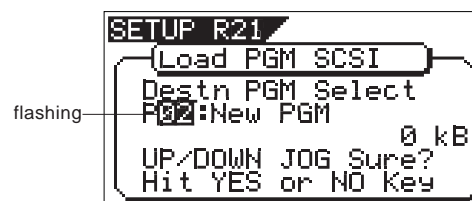

You can select any existing program available on the current drive by rotating the [JOG] dial besides "New PGM". When selecting an existing program, the data size of the current program is also shown.

When you select load data to an existing program, the backup data overwrites the existing data.

If you do not like any track to be overwritten, select "New PGM".

<Note>

If the current drive disk (destination disk of loading data) does not have enough available space for accepting the loaded data, The display shows "Disk Full" and the returns to the screen shown when carrying out step 3.

4. Use the [JOG] dial to select the load destination program and press the [ENTER/YES] key.
The data load to the selected program starts.
The display changes to something like the screen below.
As the data load goes on, the remaining data size shown on the screen counts down.

```

SETUP R21
  Load PGM SCSI
Data Loading!
  B01>>P02
VF16 Disk1   *** MB
  
```

After completing the data load from Disk-1, the display shows "Insert Disk 2", while Disk-1 is automatically ejected.

```

SETUP R21
  Load PGM SCSI
Insert Disk2
  
```

5. Insert Disk-2 (the second disk) to the SCSI device according to the display message.
In a while after inserting the disk, the VF-16 automatically starts loading data from Disk-2.
The screen looks similar to the one when loading Disk-1. As the data load goes on, the remaining data size shown on the screen counts down.

```

SETUP R21
  Load PGM SCSI
Data Loading!
  B01>>P02
VF16 Disk2   *** MB
  
```

When the load operation is completed, "Completed!" appears, while the VF-16 stops.

```

SETUP R21
  Load PGM SCSI
P02:*****
Load Completed!
  -EXIT-
Hit YES or NO Key
  
```

<Note>

You cannot abort the load operation using SCSI before completed, unlike the load operation using the S/PDIF or adat signal.

6. Press the [EXIT/NO] key (or the [STOP] key) repeatedly until exiting the Setup mode.

Save/load a WAV file

Song data can be saved to or load from a SCSI disk by the FDMS-3 (Fostex Disk Management System-3) format, as well as by the WAV file format (RIFF WAVE file format) using a DOS-formatted disk. As you can handle song data of the VF-16 with a WAV file, it is possible to directly import/export data from/to a personal computer, to playback/edit a data file with various software applications, and to import a data file edited by a computer to the VF-16.

<Important notes for using a WAV file>

About backup disks:

- The save/load by a WAV file can be done only by using a disk DOS-formatted with FAT16.

The VF-16 executes the save/load of a WAV file when it recognizes the disk DOS-formatted with FAT16. The VF-16 cannot recognize a disk DOS-formatted with FAT32.

- You cannot DOS-format a disk from the "Disk Format?" menu in the SETUP mode.

A backup disk that handles WAV files must be DOS-formatted with FAT16 by a personal computer in advance.

When a disk larger than 2 GB is DOS-formatted with FAT16, the disk is partitioned at the 2 GB maximum size. In such a case, the VF-16 only recognizes the first partition and does not recognize the following partition(s). Therefore, the maximum available size of a backup disk for the VF-16 is 2 GB.

To avoid an accidental erasure of data by overwriting, etc., we suggest to use a clean disk just formatted for the save/load of WAV files.

About directory of a backup disk:

- A WAV file saved is recorded in the root directory (in the first layer) on the backup disk.

- A WAV file that can be loaded must be allocated in the root directory on the backup disk.

A WAV file moved from the root directory to another area such as a folder cannot be recognized by the VF-16, which may cause a malfunction.

About file names of WAV files

- A WAV file the VF-16 saves is recorded with a file name "*****##.WAV".

- A WAV file the VF-16 can load must have a file name "*****##.WAV".

The first 6 characters "*****" are the title that is shown in the "Title Edit" screen in the SETUP mode. These characters can be changed when saving using a WAV file or edited by a computer.

The following 2 characters "##" indicate the track number (1 to 24) for the save/load using a WAV file. The last ".WAV" is the file extension indicating that the file format is WAV.

The VF-16 does not recognize other file names than above. See the following description for each operation about details.

By using the specifications above, you can load only the desired tracks of a WAV file or load a track-swapped WAV file. See "Loading a WAV file" described later for details.

Saving a WAV file

You can save a WAV file.

Make sure that the DOS-formatted disk with FAT16 is set. The following procedure assumes that the newly formatted "clean" disk is used for backup.

1. Press the [SETUP] key to enter the Setup mode.
The display shows the screen for selecting the Setup menu.
2. Use the [JOG] dial to select "Save PGM" and press the [ENTER/YES] key.
The display shows the screen for selecting the device to which the data is saved. "SCSI" flashes.

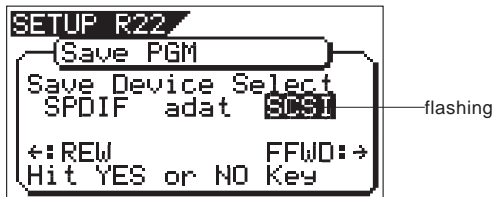

3. While "SCSI" is flashing, press the [ENTER/YES] key.
The display shows the screen for selecting the backup mode (FDMS 3 or WAV), where "WAV" flashes. (When a DOS-formatted disk is set, "WAV" initially flashes.)

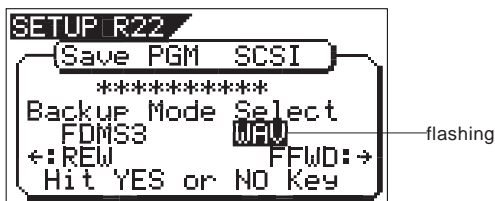

4. While "WAV" is flashing, press the [ENTER/YES] key.
The display shows the screen for selecting ON or OFF of the Clipboard export function, where "OFF" flashes. Pressing the [REWIND] or [F FWD] key switches between ON and OFF.

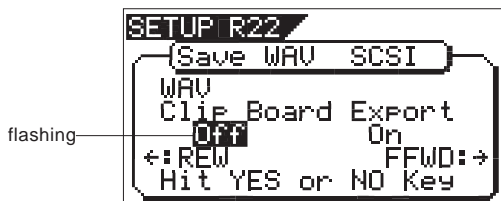

If you save all data from "ABS 0" to "REC END" (in most cases), you do not have to change the setting here.

<About the Clipboard export function>

The Clipboard export function allows you to save the desired range of data.

If you save data with this function active, only the data between the Clipboard IN and Clipboard OUT points is saved. Therefore, if you want to save only the specific range of data, you have to register the Clipboard IN and Clipboard OUT points before the save operation.

<Note>

If you save all data from "ABS 0" to "REC END", make sure to set the Clipboard export function to OFF.

5. While "OFF" is flashing, press the [ENTER/YES] key.
The display shows the screen for selecting a program to be saved. The program number currently selected flashes, while the data size of the program is shown.

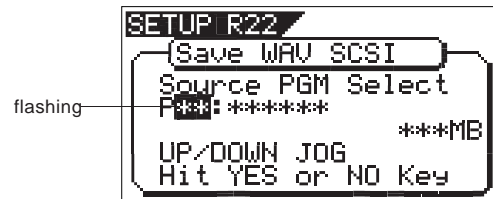

6. Use the [JOG] dial to select a program to be saved and press the [ENTER/YES] key.
The display shows the screen for selecting a track to be saved. Initially, "From All Track" flashes.

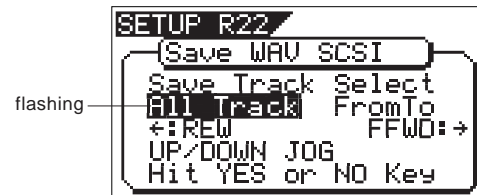

By rotating the [JOG] dial, you can select "From ** To ***" (where the left field flashes initially) instead of "From All Track". If you save data for all tracks (1 through 24), select "From All Track". If you save data for any specific track(s), select "From ** To ***" and specify the desired track numbers.

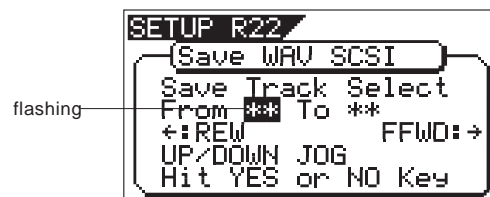

<To specify the desired tracks to "From ** To ***">

By rotating the [JOG] dial while the left ("From") field is flashing, you can select the track number from 01 through 24. The number in the right ("To") field automatically follows the number in the left field (i.e. numbers in the left and right fields are always the same). Therefore, if you want to save a single track, you just have to set the right ("From") field and do not have to set the right ("To") field. For example, "From 02 To 02" will save only track 2.

To specify tracks 5 through 12:

- Enter "05" to the left field while the left field is flashing.
- Press the [REWIND] or [F FWD] key to make the right field flashing.
- Enter "12". (Note that the number for the right field must be equal to or larger than the left field.)

Finally the screen shows "From 05 to 12" to save tracks 5 through 12.

7. After selecting the track(s), press the [ENTER/YES] key.
The display shows the screen for selecting a WAV file on the disk.
If no file is recorded on the disk, "New File" flashes. You can select "Eject" by rotating the [JOG] dial. To remove the disk, select "Eject" and press the [ENTER/YES] key.

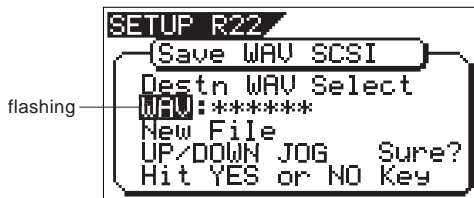

<Hints>

If the backup disk contains any existing program(s) previously saved, the display may show following screens after carrying out the previous step, depending on the available space of the backup disk.

•Showing the title and "New File":

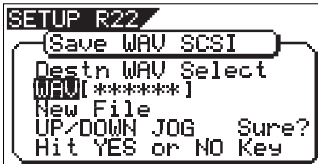

There is enough space for creating a new WAV file in addition to the existing WAV files on the disk.

Pressing the [ENTER/YES] key advances to the next step (for editing the file name).

After completing the save operation, this new WAV file will be added on the disk.

•Showing the title and "New File", and "-****MB":

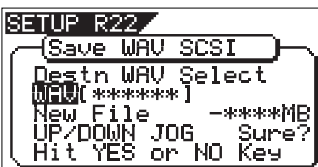

The space for adding a new WAV file to the existing WAV files on the disk is ****MB short.

Pressing the [ENTER/YES] key shows "Disk Full!", followed by "Delete All WAV?".

Pressing the [ENTER/YES] key again deletes all the WAV file on the disk and advances to the next step (for editing the file name)

After completing the save operation, only this new WAV file will remain on the disk.

•Showing the title and "****MB":

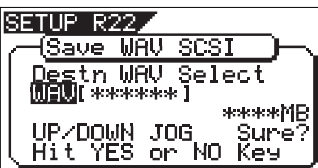

To get enough space for creating a WAV file, the specified file on the backup disk will be deleted.

By pressing the [ENTER/YES] key, "DEL" appears.

Pressing the [ENTER/YES] key again will delete the specified WAV file on the disk and advances to the next step (for editing the file name).

After completing the save operation, the specified WAV file will be replaced with the new WAV file on the disk.

•Showing the title and "-****MB":

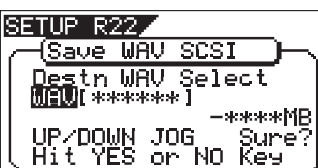

Even if the specified file is deleted, the space for creating a new WAV file on the disk is ****MB short.

Pressing the [ENTER/YES] key shows "Disk Full!", followed by "Delete All WAV?".

Pressing the [ENTER/YES] key again deletes all the WAV file on the disk and advances to the next step (for editing the file name). After completing the save operation, only the new WAV file will remain on the disk.

- After selecting a file, press the [ENTER/YES] key. The display shows the screen for editing the WAV file.

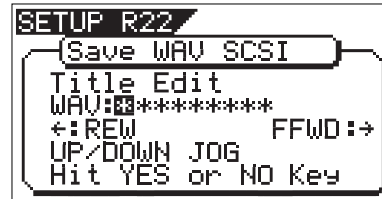

By rotating the [JOG] dial, you can enter the desired numeric, symbolic or alphabetical character in the flashing digit. You can move the flashing digit by using the [REWIND] and [F FWD] keys. See the following table for the available characters.

Upper-case alphabetical characters (A to Z)
Numerals (0 to 9)
Symbols (! # \$ % & ' () @ ^ _ -)

<Note>

You can use up to 6 characters for a file name. Some characters entered are converted as shown below.

- Upper-case alphabetical characters (A to Z): not converted
- Lower-case alphabetical characters (a to z): converted to the corresponding upper-case
- Numerals (0 to 9): not converted
- Symbols (! # \$ % & ' () @ ^ _ -): not converted
- Other symbols: converted to "_".

- After entering the file name, press the [ENTER/YES] key.

The save operation is executed and the display shows something like the one as below. As the file save goes on, the remaining data size shown on the screen counts down.

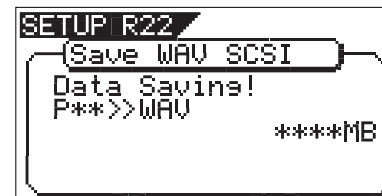

When saving data onto more than one disk, the current disk number is shown on the screen as "Disk*" (where * indicates the number).

Immediately after the data save to each disk is completed, the disk is automatically ejected, and "Insert Disk*" flashes on the screen, prompting you to insert the next disk.

Inserting the next disk resumes the save operation.

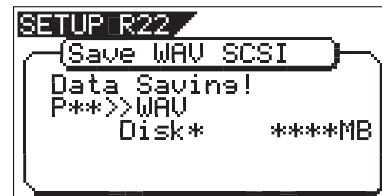

After the save operation is completed, "Completed!" appears on the screen.

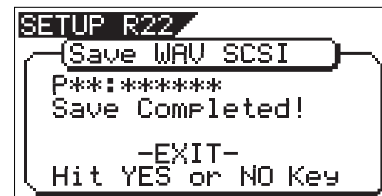

<Hint>

In the save operation which requires more than one backup disk, if you use a backup disk which contains any program(s) saved, the display shows the screen as shown below.

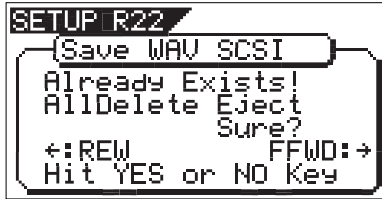

This screen is asking you whether to delete all existing WAV files on the disk or to eject the disk. To delete all the existing files, select "All Delete" and press the [ENTER/YES] key. All existing files are deleted and the disk is ready for saving data. If you do not want to delete the existing files, select "Eject" and press the [ENTER/YES] key. The disk is ejected so you can insert another disk. To select between "All Delete" and "Eject", press the [REWIND] or [F FWD] key.

10. Press the [EXIT/NO] key (or the [STOP] key) repeatedly until exiting the Setup mode.

<About WAV files saved>

•WAV file structure

A WAV file on the backup disk has 24 files (one file per track) in the root directory of the disk. The file names are "*****01.WAV" through "*****24.WAV" where "*****" shows the file name specified in step 8 above and each number (01 - 24) shows the corresponding track number. If a track has no data recorded, the corresponding file with no data is created.

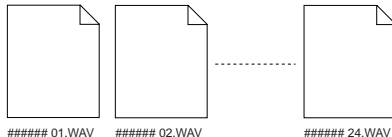

•WAV file structure which is saved over more than one disk

A WAV file is saved in order of track number (from track 1 to 24). During the save operation over more than one backup disk, the VF-16 always calculates the available space of the disk automatically. If the VF-16 knows that the available space gets smaller than the data size of the next track, it will change the disk when the data save of the current track is completed.

•WAV file size

When saving data by the WAV file format to a backup disk, the file size may sometimes increase compared with the data size in the current drive, depending on the recorded data condition such as the start time, end time, the data amount, etc. on each track. For example, if a track is recorded from ABS:0 (min.) to ABS:1 (min.) and ABS:10 (min.) to ABS 11 (min.), the file on the current drive has a length of 2 minutes, while the WAV file has a length of 11 minutes. Also as mentioned above, if a track has no data recorded, the corresponding WAV file with no data is created though the size is small.

<Notes>

- If the file name you are going to save duplicates with the existing WAV file name on the backup disk, "Warning! Already Exist" is shown on the screen and the save operation will not be executed. In such a case, change the file name according to the procedure above and carry out the save operation again.
- A disk on which you have overwritten data many times may lower the access speed because of the disk fragmentation. Therefore, we suggest that you should use a newly formatted "clean" disk for backup.
- If any other file but "*****#.WAV" or folder, which cannot be recognized by the VF-16, is created on the backup disk using a personal computer, the VF-16 cannot calculate the available backup disk space accurately. Accordingly, it may happen that the save operation cannot be completed. You should note this when changing the file name or creating a folder using your computer.

Loading a WAV file

1. Press the [SETUP] key to enter the Setup mode. The display shows the screen for selecting the Setup menu.
2. Use the [JOG] dial to select "Load PGM" and press the [ENTER/YES] key. The display shows the screen for selecting the device from which the data is loaded. "SCSI" flashes.
3. While "SCSI" is flashing, press the [ENTER/YES] key. The display shows the drive name and "DOS Format", followed by the screen for selecting the WAV file to be loaded, showing the WAV file name and size. If no disk is inserted, "No SCSI Disk!" is shown.

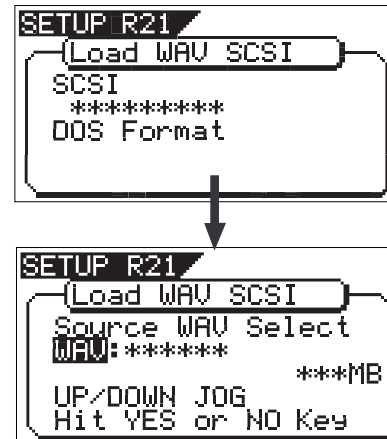

4. Use the [JOG] dial to select the desired WAV file to be loaded. If more than one WAV file with different file names (the first 6 characters) is saved, you can see each file name (by the first 6 characters) in order when rotating the [JOG] dial. You can also select "Eject" to remove the backup disk.

<Note>

The VF-16 cannot recognize any other file names but "*****#.WAV" and cannot load such disks. A WAV file with a unique name (the first 6 characters) is recognized as an independent backup file and can be selected.

- After selecting the desired WAV file, press the [ENTER/YES] key.

The display shows the screen for selecting a track to be loaded. "All" flashes initially. Besides "All", you can select any one of tracks (01 through 24) by rotating the [JOG] dial.

WAV[*****]

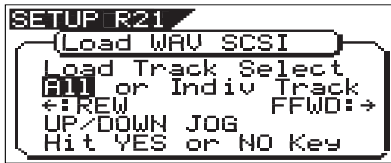

- After selecting the desired track(s), press the [ENTER/YES] key.

The display shows the screen for selecting the load destination program to which a WAV file is loaded. You can select the program by using the [JOG] dial.

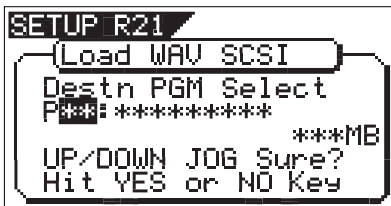

When the screen shows "Title" and "Size", the selected program will be deleted and replaced with the WAV file loaded.

When the screen shows "Title" and "New PGM", the WAV file loaded will create a new program.

<Note>
 If the current drive does not have enough available space for loading the WAV file, the size indication on the screen shows a negative value ("_*").
 In such a case, select a program that can be replaced with the WAV file loaded without causing the disk space shortage, or delete unnecessary programs by the "Delete PGM" menu in the SETUP mode.

- After selecting the load destination program, press the [ENTER/YES] key.

When selecting a new program as the load destination (by selecting an option showing "Title" and "New PGM"), the load operation immediately starts. When selecting an existing program as the load destination (by selecting an option showing "Title" and "Size"), "Overwrite?" and "Sure?" appear. Pressing the [ENTER/YES] key will start the load operation. During the load operation, the screen shows something like the one as below. As the data load goes on, the remaining data size shown on the screen counts down.

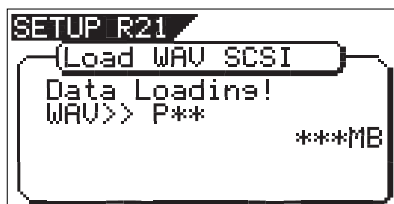

When the load operation is completed, "Completed!" appears on the screen.

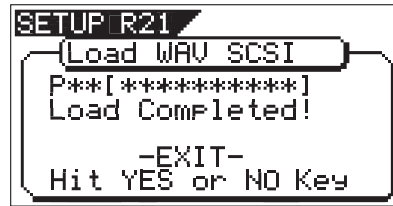

<Note>
 The title of the program to which the WAV file is loaded is replaced with the WAV file name loaded (the first 6 characters).

- Press the [EXIT/NO] key (or the [STOP] key) repeatedly until exiting the Setup mode.

To go back to the previous step or abort the operation, you can also use the [EXIT/NO] key or the [STOP] key.

<< Special loading method when using a computer >>

< Note >

WAV files which can be saved/loaded by this recorder must have file names written as "*****##.WAV."
Other file names cannot be acknowledged by this recorder.

Unknown file names will not be acknowledged and could cause malfunction. Extreme care should be taken when changing file names and making folders on a computer.

- * The first six letters will be the title shown in the SETUP mode "Title Edit" display.
- * The last two letters "##" represent each track number (1-24) of the WAV file which are to be saved/loaded.
- * The last "WAV" is the extension which indicate that this is a WAV file.
- * File name of the WAV file which is to be saved in the backup disk of this recorder will all be recorded in capital letters. However, in certain computers, this WAV file name will be displayed in small letters.

(*) Method to load specific tracks.

The backup disk in which files are saved will contain files from "*****01.WAV" up to "*****24.WAV." Should these files be deleted, moved from the root directory, for example, into a another folder or the file name changed which cannot be acknowledged, this recorder will not recognize this file.

When a backup disk changed in this manner is loaded, only WAV files with file names "*****##.WAV" which are located in an acknowledgeable root directory can be loaded.

For example, if the "zero number of data" made at save is deleted from the backup disk and then load is executed, only WAV files recorded with any other sound can be loaded.

(*) When loading WAV files saved in a multiple number of disks, they can be loaded by a special method derived from the above method.

Assume that there is backup disc 1 saved with "*****01.WAV" through "*****12.WAV" and disc 2 saved with "*****13.WAV" through "*****24.WAV."

First, when backup disk 1 is loaded, files in tracks 1-12 will be loaded. At this point, tracks 13-24 will not be loaded and thus be non-recorded. Next, when backup disk 2 is loaded, files in tracks 1-12 remains intact and tracks 13-24 only will be loaded.

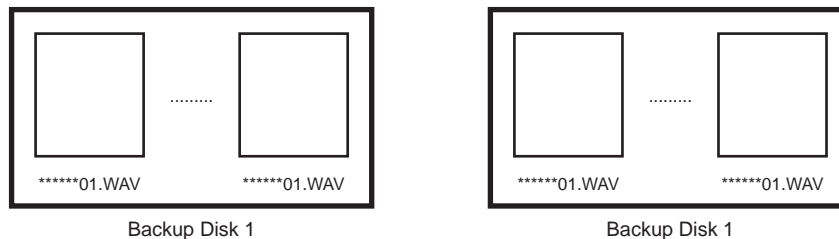

(*) Method in loading by changing the track.

If the two letters "##" in file name "*****##.WAV" in the backup disk are changed, it will be possible to load them on this recorder on a track different from that at the initial save. For example, if a WAV file named "ABCDEF01.WAV" on track 1 is changed to "ABCDEF03.WAV" this WAV file will be loaded on track 3.

(*) Method in loading by changing the title.

If the 6 letters "*****" in file name "*****##.WAV" in the backup disk are changed, it will be possible to load them on this recorder under a title different from that at the first save. Letters which can be used at changing the file name in a computer are those only indicated below. All of these letters must be one byte size.

Alphabets	: A-Z and a-z
Numerals	: 0-9
Symbols	: !#\$%&'()@'_ =

Chapter 7 SETUP mode

The SETUP mode of the VF-16 offers the “Changing the initial settings” menus, which configure the operating environment of the VF-16, a “Check” menu that enables you to check the number of events for each track, and an “Execution” menu that executes certain operations, such as save and load and disk formatting. The “Changing the initial settings” menu include 20 parameters as shown in <Table-1> below. These parameters were set before the VF-16 was shipped from the factory and these values are called the “initial settings.” Modifying these settings allows you to change the operating environment of the VF-16. The “Check” menu provides two parameters “Checking the number of events” as shown in <Table-2> - “Checking the number of events” and “Checking the current drive information.”

Also, as shown in <Table-3>, the “Execution” menus include five items: Title Edit, Delete PGM, Load PGM, Save PGM, and Disk Format, which you can execute by selecting the corresponding SETUP menu. This chapter explains how to use the “Changing the initial settings” menus shown in <Table-1> and the “Check” menu shown in <Table-2>.

For more information on the “Execution” menus, refer to the corresponding pages in the “Reference page” column in <Table-3>.

<Table-1> “Changing the initial settings” menu

Parameters	Display	Default setting	Refer page	Community
Setting a time signature	Signature Set	001BAR 4/4	99	○
Setting a tempo	Tempo Set	001BAR 1♩120	100	○
Setting the metronome function	Click ♩	Off	102	○
Setting a preroll time	Preroll Time	00s	103	○
Setting MIDI sync output signal	Midi Sync Out	MTC	103	○
Setting an MTC frame rate	Frame Rate	25 frame	104	○
Setting an MTC offset value	Mtc Offset	00h 59m 57s 00f 00sf	104	○
Setting the offset mode	Offset Mode	ABS	105	○
Setting the slave mode	Slave Mode	Off	105	○
Setting the slave type	Slave Type	Vari	106	○
Setting the record protect function	Rec Protect	Off	106	○
Setting digital input	Digital In	Analog	107	●
Setting digital output	Digital Out	SPDIF	108	●
Setting BAR/BEAT resolution mode	♩ Resolution	Off	108	●
Setting the MIDI device ID number	Device ID	00	109	●
Setting the drive	Drive Select	IDE	110	-
Setting the fader fix mode	Fader Fix	Off	111	○
Setting the fader recall mode	Fader Recall	Off	111	○
Setting the phantom power	Phantom Power	Off	112	●
Setting the compressor channel	Comp. Channel	Off	112	●

○: Modes applicable program by program. They can be saved/loaded.

●: Modes applicable to all program. They cannot be saved/loaded.

<Table-2> “Check” menu

Check item	Display	Refer page	Community
Check of the event number on the track	Number Of Event	109	-
Check of the current drive information	Drive Information	110	-

<Table-3> “Execution” menu

Execution item	Display	Refer page	Community
Editing a program title	Title Edit	62	-
Deleting a program	Delete	62	-
Saving song data to an external device	Load PGM	80	-
Loading song data from an external device	Save PGM	80	-
Formatting an current drive disk	Disk Format	21	-

To enter the SETUP mode

Entering the SETUP is possible only when the VF-16 is in the Stop mode.

1. While the recorder is stopped, press the [SETUP] key on the operating panel.

When the [SETUP] key is pressed, the recorder enters the SETUP mode first stage and change to the display for selecting the SETUP menu. The white black reversed title indicates the currently selected menu and the ▼ (flash) indicates that other titles exist below.

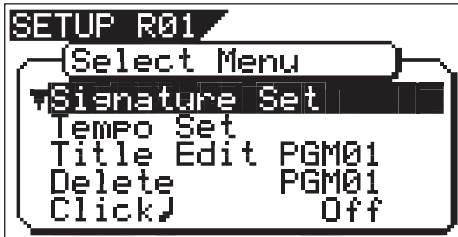

<Note>

At shipping from the plant or when power is switched on again, the "Signature Set" menu will be reversed in white-black. Otherwise, when exiting from the SETUP mode, the SETUP menu that was displayed last will be reversed in black and white.

2. If the desired menu is selected via the [JOG] dial and the [ENTER/YES] key pressed, you can proceed to the actual setup procedure.

<Important>

- * To exit from the SETUP mode or return to the previous level, press the [EXIT/NO] key (or [STOP] key).
- * When selecting the desired SETUP menu, the [HOLD/ >], [REWIND] and [F FWD] keys can be used in addition to the [JOG] dial.

Time signature setting ["Signature Set"]

Using the "Setting a time signature" menu, you can set a time signature of a given measure on the internal programmable Tempo Map. Also in this setting, the BAR (-002BAR, 1J, 00CLK) displayed at the head of the disk in the time base BAR/BEAT/CLK can be set within a range of -009BAR ~ -002BAR.

For example, you can specify 4/4 for the first and second measures, and 2/2 from the third measure." Setting a time signature and tempo will create a Tempo Map, which allows the VF-16 to manage a song using the BAR/BEAT/CLK Time Base. You can also use the Metronome function.

A time signature and tempo setting are required when MIDI clock & song position pointer are output to an external sequencer.

- * Initial Setting : 001bar 4/4 beat
- * Available bars : 001 ~ 999
- * Available time signature : 1/4, 2/4, 3/4, 4/4, 5/4, 1/8, 3/8, 5/8, 6/8, 7/8, 8/8, DEL
- * Maximum setting points : 64
- * The setting is applicable song by song.
- * The setting can be saved or loaded as a part of the song data
- * The setting is memorized even when the power is off.
- * Make sure you choose the right program before setting this mode.

1. Select a program for which to set a time signature.
2. In the menu selecting display, select "Signature Set" and press the [ENTER/YES] key.

The display will change to confirming the currently set signature. In the initial setting, the display will be as shown below to indicate that the bar offset is -002BAR, signature from the first bar is set to 4/4, and nothing is set after the first bar.

If the [JOG] dial is rotated, items displayed can be alternately selected. "-002BAR Offset" to setup the bar offset figure, "Insert New Event" to setup a new signature following the first bar, and "All Clear" to clear all signature/tempo settings, can be selected.

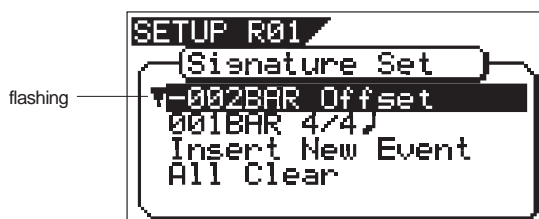

New Registering of Time Signature

3. While in the previous step 2 display, select "Insert New Event" and press the [ENTER/YES] key.

The "Insert New Event" display section will change to the display for setting up a new bar and the "002" number will flash.

At this point, the bar figure displayed will be the bar figure setup last +1 and the signature figure displayed will be same as the last setting (Example: In the initial state, "002BAR 4/4 J" will be shown.

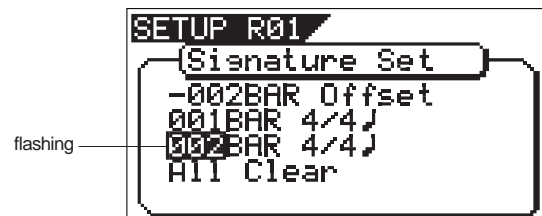

4. Input the desired bar figure with the [JOG] dial and press the [ENTER/YES] key.

It will change to flashing of "4/4J."

5. Input the desired meter via the [JOG] dial and press the [ENTER/YES] key.

The input bar and signature figures will be set as shown in the following. This display is an example of setting the third bar to 3/4 beat. If the [JOG] dial is rotated, the editing point of bar or signature, like the figures shown below, can be input.

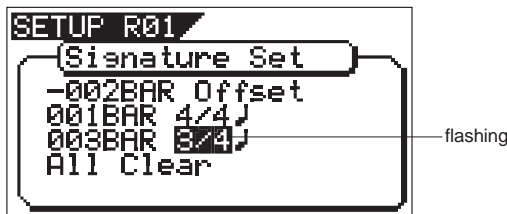

The following bar numbers and time signatures can be entered via the [JOG] dial.

Bar	You can enter are from 001 to 999.
Time Signature	1/4, 2/4, 3/4, 4/4, 5/4, 1/8, 3/8, 5/8, 6/8, 7/8, 8/8 or DEL "DEL" is used to deleted time signature data.

- Next, to register other bar and time signature, repeat steps 2 through 5.
- Upon completion of registering, press the [EXIT/NO] key (or the [STOP] key) and exit from the SETUP mode.

Correcting the Registered Time Signature

- Under the previous "Confirmation display," select bar/ time signatures to be changed and press the [ENTER/ YES] key.
- Input the desired signature via the [JOG] dial and press the [ENTER/YES] key.
The newly input signature will be setup.

Time Signature	1/4, 2/4, 3/4, 4/4, 5/4, 1/8, 3/8, 5/8, 6/8, 7/8, 8/8 or DEL "DEL" is used to deleted time signature data.
----------------	--

- Upon finishing, press the [EXIT/NO] key (or [STOP] key) to exit from the SETUP mode.

Deleting a Time Signature

- Under the above "Confirmation display," select bar/ time signatures to be deleted and press the [ENTER/ YES] key.
- Press the [ENTER/YES] key again to make "*/* J" to flash and input "DEL" via the JOG dial.

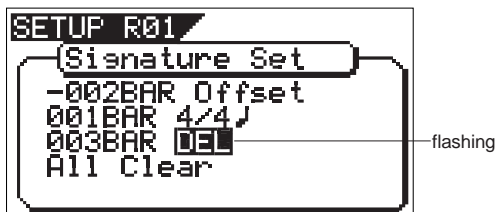

- Press the [ENTER/YES] key.
The selected measure/signature setting will be deleted.
- After deleting, press the [EXIT/NO] key (or [STOP] key) to exit from the SETUP mode.

<Note>
You cannot register the "001BAR" of "001BAR 4/4 J."

<Note>
Take care because this procedure wipes out the tempo setting as well as time signature setting.

Clearing All Time Signature/Tempo Data

<Note>
Be careful because this procedure wipes out the tempo setting as well as time signature setting.

- Under the above "Confirmation display," select "All Clear" and press the [ENTER/YES] key.
A following display of "All Clear," "SURE ?" will flash. This indicates the standby mode for clearing all signature setting data and the tempo data.

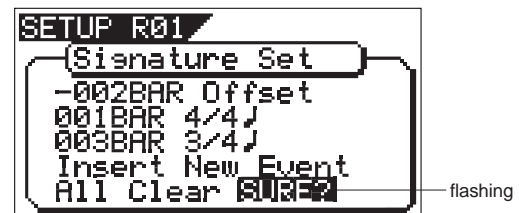

- Press the [ENTER/YES] key.
Except for the initial setting "001BAR 4/4 J," other time signature settings and the tempo setting will be cleared at the same time.
- Press the [EXIT/NO] key (or STOP key) to exit from the SETUP mode.

Changing the Bar Offset Figure

- Under the above "Confirmation display," select "-002BAR Offset" and press the [ENTER/YES] key.
The "-002" display will change to flashing.



- Input the desired offset value with the [JOG] dial and press the [ENTER/YES] key.
Offset value can be input in the -2 through -9 range.
- After correction, press the [EXIT/NO] key (or [STOP] key) to exit from the SETUP mode.

Setting a tempo ["Tempo Set"]

The "Tempo Map Set" menu enables you to specify a tempo at a given point in a song that already has a time signature setting. For example, you can specify a tempo of 150 to the third beat of the 12th measure. Time signature and tempo settings make a Tempo Map, which is used by the VF-16 to manage the song using the BAR/BEAT/CLK time base, and enable the metronome function. Tempo settings as well as time signature settings are required when you wish to output MIDI clock and Song Position Pointer to an external sequencer.

<Note>

The tempo set figure setup here is an approximate figure and thus not accurate. Therefore, although the tempo map be matched with a personal computer, they will gradually drift apart. In order to prevent this drift, the personal computer side can be set to either MIDI clock sync or, the MIDI sync output signal temporarily set to "MIDI Clock" the figure reset to make it possible for the computer to read the accurate tempo, and the return it again to MTC sync.

- * Initial Setting: 001BAR 1st beat 120 bpm
- * Bar to register: Follows to the time signature setting
- * Beat to register: Follows to the time signature setting
- * Available tempo: 30 ~ 250, DEL (delete)
- * Maximum setting points: 64
- * The setting is applicable song by song.
- * The setting can be saved or loaded as a part of the song data
- * The setting is memorized even when the power is off.
- * Make sure you choose the right program before setting this mode.

1. Select a program for which to set a tempo setting.
2. Under the menu selection display, select "Tempo Set" and press the [ENTER/YES] key.
The display will change, confirming the current tempo setting. At the initial setting, the display will be as shown below, indicating that tempo of the first beat for the 001 bar is 120 and subsequent tempo is not setup. "Insert New Event" should be selected at setup of a new tempo. When the [JOG] dial is rotated, the currently displayed items can be selected alternately.

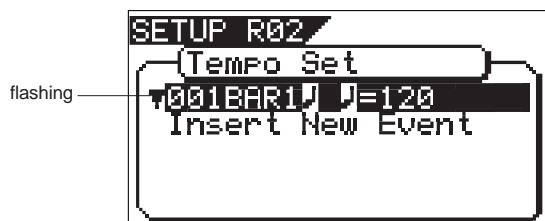

New Registering of Tempo

1. Under the above "Confirmation display," select "Insert New Event" and press the [ENTER/YES] key.
The "Insert New Event" section will change to new tempo setup display and "002" will flash. The bar value thus displayed will be the last setup bar value +1 and tempo value will be identical with the last setting (Example: In the initial setup state, "002BAR 1 J=120" will be displayed.

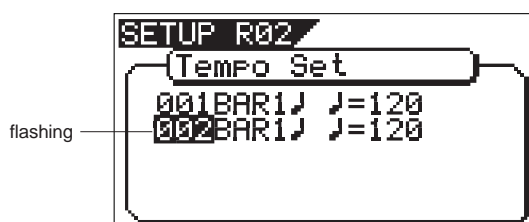

2. Input the desired bar with the [JOG] dial and press the [ENTER/YES] key.
The bar value that can be input is identical with the above "signature setup." When the [ENTER/YES] key is pressed, "beat value" will change to flashing.
3. Input the desired beat with the [JOG] dial and press the [ENTER/YES] key.
The meter value that can be input is identical with the above "signature setup." When the [ENTER/YES] key is pressed, "tempo value" will change to flashing.
4. Input the desired tempo with the [JOG] dial and press the [ENTER/YES] key.
The tempo can be input within the range of 30 through 250. When the [ENTER/YES] key is pressed, the tempo map value thus input will be set and return to the above mentioned "Confirmation display for tempo map."
5. To register another tempo map, repeat steps 1 through 4.
6. Upon completing registering, press the [EXIT/NO] key (or [STOP] key) to exit from the SETUP mode.

For a setup example, if it is attempted to setup the following tempo in the music that is set to [001BAR 4/4 J] and [005BAR 3/4 J] by the previous "signature setup," as seen in the music score below, the tempo map must be set as follows.

Tempo Map	
Time signature setting	Tempo setting
001 BAR 4/4 J	001 BAR 1 J = 120 003 BAR 1 J = 90
005 BAR 3/4 J	005 BAR 3 J = 60 007 BAR 2 J = 120

Correction of the Registered Tempo

- Under the above "Confirmation display," select the tempo map which is to be changed and press the [ENTER/YES] key.
The same as before, "tempo value" will flash.
- Input the desired tempo with the [JOG] dial and press the [ENTER/YES] key.
- Upon completing registering, press the [EXIT/NO] key (or [STOP] key) to exit from the SETUP mode.

Erasing of the Registered Tempo

- Under the above "Confirmation display," select the tempo map which is to be erased and press the [ENTER/YES] key.
The same as before, "tempo value" will flash.
- Input the "DEL" with the [JOG] dial.
"DEL" will flash.



- Press the [ENTER/YES] key.
The selected tempo map will be erased.
- Upon completing registering, press the [EXIT/NO] key (or [STOP] key) to exit from the SETUP mode.

<Note>
You cannot register the "001BAR 1 J=120."

Setting the Metronome function ["Click"]

"Setting the Metronome function" menu allows you to determine whether or not the VF-16 outputs a metronome sound from track 16 during playback or recording. Turning the Metronome function on enables you to record your performance while playing the instrument accompanying the metronome sound.

<Note>
Metronome sound will be output from track 16.
For this reason, when the metronome function is activated, a new sound source cannot be recorded on the track to which the metronome sound is to be output or sound recorded on this track cannot be played back.
If the metronome function is not to be used, be sure to reset it to "Off."

- * Initial Setting : [Off]
- * Available setting : [Off] or [On]
- * The setting is applicable song by song.
- * The setting can be saved or loaded as a part of the song data
- * The setting is memorized even when the power is off.
- * Make sure you choose the right program before setting this mode.

- Select "Click" in the menu selection display and press the [ENTER/YES] key.
The currently set item (Off or On) will flash ("Off" will flash if in the initial state).

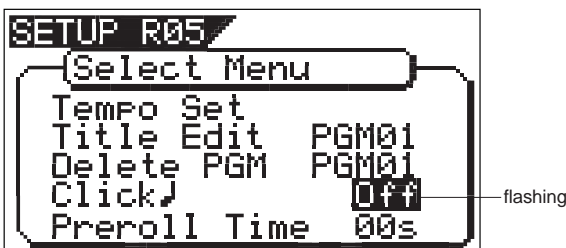

- Select "On" or "Off" with the [JOG] dial and press the [ENTER/YES] key.
The selected item will be setup.

On	Metronome sound will be output from track 16.
Off (default)	Metronome sound will not be output.

- Press the [EXIT/NO] key (or [STOP] key) to exit from the SETUP mode.

Setting a preroll value ["Preroll Time"]

The VF-16 features a Preroll function that enables you to locate a position a few seconds prior to a specified locate point. The "Setting a preroll value" menu enables you to set the preroll time (in seconds).

The Preroll function is convenient when you wish to monitor the audio data from a point slightly before the locate point.

- Initial setting: [00] second
- Setting range of preroll time: [00]-[10] seconds in one second steps
- * You can set the value for each Program individually.
- * The settings can be saved and loaded as part of the song data.
- * The settings are maintained after you turn off the power to the VF-16.

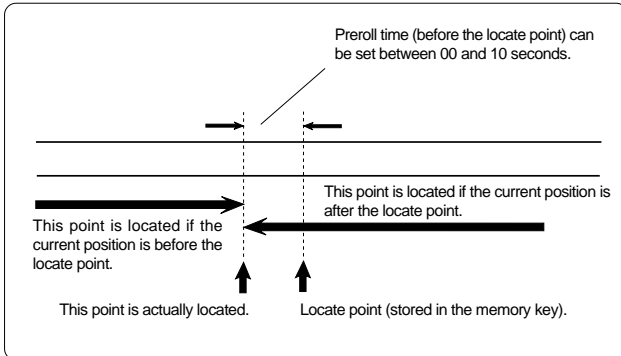

1. Select "Preroll Time" in the menu selection display and press the [ENTER/YES] key.

The currently set preroll time will flash. "00" will flash in the initial setting.

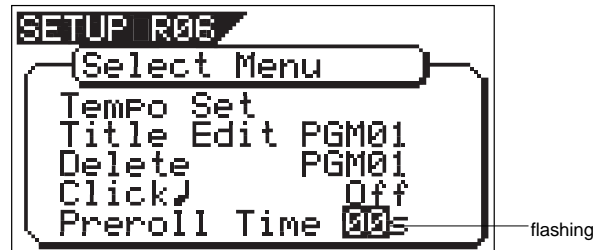

2. Input the desired preroll value with the [JOG] dial and press the [ENTER/YES] key. The recorder will be set to the Preroll time thus input.

3. Press the [EXIT/NO] key (or STOP key) to exit from the SETUP mode.

Setting MIDI sync output signal ["Midi Sync Out"]

The "Setting MIDI sync output signal" menu enables you to select the type of MIDI sync signals output from the MIDI OUT connector on the rear panel of the VF-16 to an external MIDI device.

The options are MIDI clock & Song Position Pointer, or MTC (MIDI time code). Select an appropriate option depending on the type of signal supported by the connected MIDI device.

If you select MIDI clock & Song Position Pointer, first you need to set the time signatures and tempo as described previously. If you select MTC, you first need to set the MTC frame rate, the MTC offset time, and the MTC offset mode as described later.

- Initial setting: [MTC]
- Option: [CLK] (clock & Song Position Pointer), [MTC] (MIDI time code), or [Off] (no output)
- * You can set the parameters for each Program individually.
- * The settings can be saved and loaded as part of the song data.
- * The settings are maintained after you turn off the power to the VF-16.

2. Select the desired MIDI sync signal with the [JOG] dial and press the [ENTER/YES] key.

CLK (Initial setting)	MIDI clock and song position pointer will be output.
MTC	MIDI time code will be output.
Off	Any MIDI sync signal will not be output.

1. Select "Midi Sync Out" in the menu selection display and press the [ENTER/YES] key.

The currently set item will flash. "CLK" will flash in initial setting.

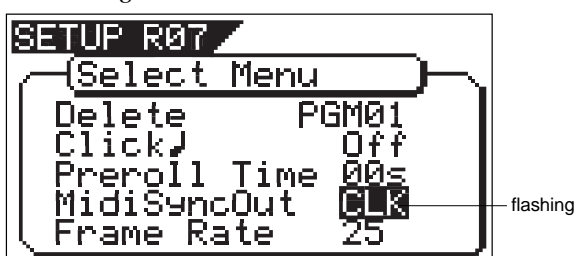

3. Press the [EXIT/NO] key (or STOP key) to exit from the SETUP mode.

Setting an MTC frame rate ["Frame Rate"]

The "Setting an MTC frame rate" menu enables you to set the frame rate for MTC output from the MIDI OUT connector of the VF-16 to an external MIDI device. If you have already set the type of MIDI sync output signal to [MTC], you need to set the frame rate. Use the frame rate of MTC received by the external MIDI device (or sequence software).

- Initial setting: [25] (25 frames)
- Setting range of frame rate: [24], [25], [29df], [29nd], [30df] or [30nd]
- * You can set the value for each Program individually.
- * The settings can be saved and loaded as part of the song data.
- * The settings are maintained after you turn off the power to the VF-16.

1. Select "Frame Rate" in the menu selection display and press the [ENTER/YES] key. The currently set frame rate will flash. "25" will flash in the initial setting.

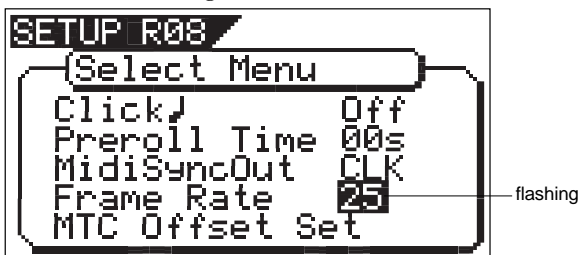

2. Select the desired frame rate value with the [JOG] dial and press the [ENTER/YES] key. It will be set to the selected frame rate.
3. Press the [EXIT/NO] key (or STOP key) to exit from the SETUP mode.

<Note>

There are no 29.97nd or 29.97df in the MTC standard. Use either 30nd or 30df unless you definitely need to synchronize the VF-16 with NTSC video.

Setting an MTC offset value ["Mtc Offset Set"]

The "Setting an MTC offset value" menu enables you to specify an offset time value - the difference between the time of MTC output from the VF-16 and the ABS 00m 00s 00f 00sf time. You need to specify this value if you have selected [MTC] for the "Setting MIDI sync output signal" menu.

With the initial setting of 00h 59m 57s 00f 00sf, for example, MTC of 59m 57s 00f 00sf is output at the ABS time 00m 00s 00f 00sf. You can also set an offset value from the 001bar 1beat 00clk value (bar/beat) on the Tempo Map. Refer to the next section for information on MTC Offset mode.

- Initial setting: [00h: 59m: 57s: 00f: 00sf]
- Setting range of offset time: 00h: 00m: 00s: 00f: 00sf ~ 23h: 59m: 59s: 29f: 99sf
- * You can set the value for each Program individually.
- * The settings can be saved and loaded as part of the song data.
- * The settings are maintained after you turn off the power to the VF-16.

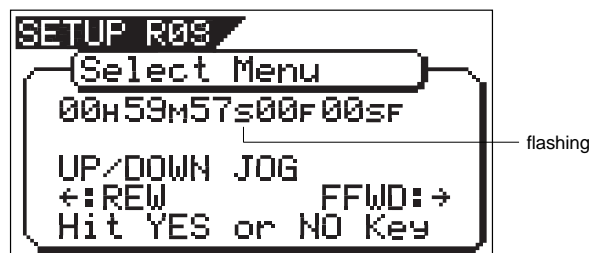

<Note>

For example, if you set MTC Offset mode to "ABS" (See the next section) and you wish to start the song from MTC's 01h 00m 00s 00f, you may wish to set a preroll of three seconds with an MTC offset of 00h 59m 57s 00f.

1. Select "Mtc Offset Set" in the menu selection display and press the [ENTER/YES] key. It will change to the second level display of the [Mtc Offset] menu and the currently set offset value will be shown. 00h 59m 00f 00sf will be displayed in the initial state and "s" will flash. Flashing indicates the editable point.

2. Move the edit point with the [F FWD] key/[REWIND] key, input the desired offset with the [JOG] dial, then press the [ENTER/YES] key. Offset value thus input will be set. Advancing or retarding the input figure is carried out automatically with reference to the currently set MTC frame rate figure.
3. Press the [EXIT/NO] key (or STOP key) to exit from the SETUP mode.

Setting MTC Offset mode ["Offset Mode"]

If you have selected [MTC] in the "Setting Offset mode" menu, you need to select MTC Offset mode.

This menu enables you to determine whether the specified MTC is output at ABS 00h 00m 00s 00f or at 001bar 1beat 00clk (bar/beat) of the Tempo Map.

<Notes>

* As an example, if you set MTC Offset mode to "ABS" and you wish to start the song from MTC's 1h 00m 00s 00f, you may want to set a preroll of three seconds with MTC offset of 00h 59m 57s 00f.

If you select "BAR" as the MTC Offset mode, a preroll of two measures is automatically set. Use 01h 00m 00s 00f; do not set a preroll value.

* If you set Offset mode to "BAR" and use MTC to synchronize sequence software on the computer, the tempo of the sequencer may sometimes slip gradually. This is because the tempo of the VF-16 and the tempo of the software are slightly different even if both use the same tempo. Some sequence software can read the tempo output from the VF-16 correctly. We recommend that you use the tempo of the VF-16 on the sequence software. No such problems will occur if the sequence software synchronizes the VF-16 via MIDI clock, instead of MTC.

- Initial setting: [ABS]
- Offset mode option: [ABS] or [Bar ↵]
- * You can set the mode for each Program individually.
- * The settings can be saved and loaded as part of the song data.
- * The settings are maintained after you turn off the power to the VF-16.

1. Select "Offset Mode" in the menu selection display and press the [ENTER/YES] key.
The currently set offset mode will flash. "ABS" will flash in the initial setting.

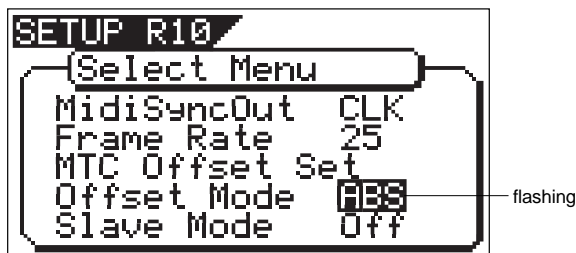

2. Select the desired offset mode with the [JOG] dial and press the [ENTER/YES] key.
The selected offset mode will be set.

[ABS] (Initial setting)	The specified MTC offset time is output at ABS 00h 00m 00s 00f.
[BAR ↵]	The specified MTC offset time is output at 001bar 1beat 00clk of the Tempo Map.

3. Press the [EXIT/NO] key (or STOP key) to exit from the SETUP mode.

Setting the Slave mode ["Slave Mode"]

This mode allows you to choose the VF-16 slave mode setting either On or Off.

If you set the slave mode to "On", the VF-16 will synchronize to the incoming MTC (MIDI Time Code) from master unit. It will also synchronize to a type of external sync signal which you have chosen with the section "Slave Type setting."

- Initial setting: [Off]
- Offset mode option: [On] or [Off]
- * You can set the mode for each Program individually.
- * The settings can be saved and loaded as part of the song data.
- * The settings are maintained after you turn off the power to the VF-16.

1. Select "Slave Mode" in the menu selection display and press the [ENTER/YES] key.
The currently set slave mode will flash. "Off" will flash in the initial setting.

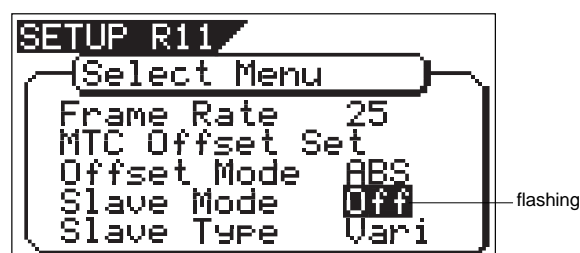

2. Select "On" or "Off" with the [JOG] dial and press the [ENTER/YES] key.
3. Press the [EXIT/NO] key (or STOP key) to exit from the SETUP mode.

Upon exit from the SETUP mode, the "SLV" (SLAVE) icon will flash.

This icon will change to constant lighting when VF-16 is correctly synchronized with the external equipment.

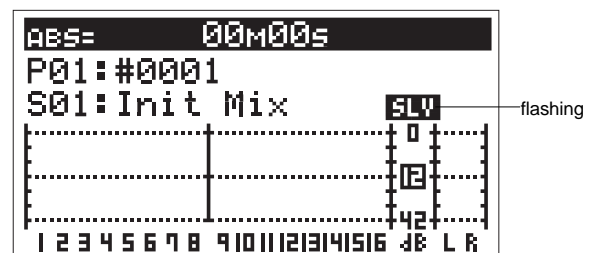

Setting the Slave Type ["Slave Type"]

If you have set Slave Mode to "On" in the previous section "Slave Mode Setting," you can choose what type of external sync signal that the VF-16 synchronizes to. This mode allows you to choose the external sync signal type.

- Initial setting: [Vari]
- Offset mode option: [Vari], [Free], [SPDIF] or [adat]
- * You can set the mode for each Program individually.
- * The settings can be saved and loaded as part of the song data.
- * The settings are maintained after you turn off the power to the VF-16.

<Notes>

- * You need to input MTC from an external device to the VF-16 with any Slave Type.
- * The VF-16 re-chase window is fixed to ten frames. That is, if an offset between the master device and slave device exceeds ten frames, the VF-16 interprets that as out of sync, and tried to chase and lock to MTC sent from the master device. This operation is called "re-chasing." During the re-chase operation, audio output is muted. If the slave machine slips with MTC from the master device by less than ten frames, the slave machine continues running while recognizing the slippage.
- * When you set the Slave Type, the Vari Pitch function is automatically disabled. (The "VARI PITCH" indicator turns off.)

1. Select "Slave Type" in the menu selection display and press the [ENTER/YES] key.
The currently set slave type will flash. "Vari" will bflash in the initial setting.

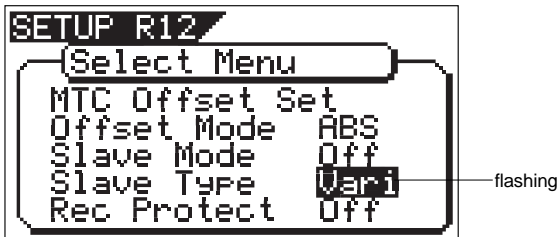

2. Select the desired slave type with the [JOG] dial and press the [ENTER/YES] key.
It will be set to the selected slave type.

Free	This is the mode whereby after chase locking, it will free run by the internal clock of VF-16 or the digital in clock from the external equipment should the time drift away from that of the master.
Vari (Initial setting)	This is the mode whereby after chase locking, it will constantly run by vari-pitch so that the time does not drift away from that of the master by compensating the phase drift. However, if digital in has been set, it will operate the same as for "Free."
SPDIF	This is the mode whereby after chase locking, it will free run by the S/P DIF clock only when there is S/P DIF digital signals from the master. However, if digital in has been set, that clock will have priority.
adat	This is the mode whereby after chase locking, it will free run by only the adat clock when there is input of adat digital signals from the master. However, if digital in has been set, that clock will have priority.

3. Press the [EXIT/NO] key (or STOP key) to exit from the SETUP mode.

Setting the Record Protect function ["Rec Protect"]

The "Setting the Record Protect function" menu allows you to turn the Record Protection function On or Off. When this function is turned "On", you cannot record, paste, or erase data. Use this function to protect your important data from being accidentally erased.

- Initial setting: [Off]
- Offset mode option: [On] or [Off]
- * You can set the mode for each Program individually.
- * The settings can be saved and loaded as part of the song data.
- * The settings are maintained after you turn off the power to the VF-16.

1. Select "Rec Protect" in the menu selection display and then press the [ENTER/YES] key.
The presently set item (On or Off) will flash. "Off" will flash in the initial setting.

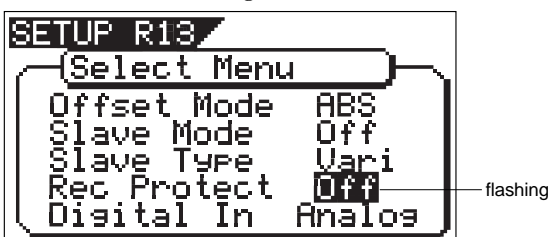

2. Select "On" or "Off" with the [JOG] dial and then press the [ENTER/YES] key.
It will be set to the selected item (On or Off).

Selecting "Off" enables recording; you can record, paste, and erase data.

Selecting "On" disables recording; and you cannot record, paste, or erase data.

3. Press the [EXIT/NO] key (or STOP key) to exit from the SETUP mode.

<Note>

When recording is disabled ("On") and you try to record, paste, or erase data, the VF-16 displays "Protected!" for a second, indicating that you cannot perform the operation. To perform the operation you need to enable recording ("Off").

Setting Digital Input ["Digital In"]

In the [Setting digital input] menu, whether the signal assigned to tracks 1 through 16 are digital signals (adat digital signal/SP DIF digital signal) or analog signals, can be setup.

By using this function, it becomes possible to digitally record from external digital equipment (CD, MD, DAT, adat, digital mixer, etc.). If "S/P DIF" is selected for input of digital, the S/P DIF signal (L, R) applied to DIGITAL/DATA INPUT of VF-16, it will be assigned to any two tracks, and if "adat" is selected, the adat signals will be assigned to tracks 1 through 8.

If it is set to "Analog", analog signals input to the mixer will be assigned to tracks 1 through 16.

<Note>

If set to "S/P DIF or adat", "DIGITAL" will be lit in the display when the DIGITAL/DATA INPUT is locked. Should "DIGITAL" blink, check the connecting cables between external equipment and recheck the setups of VF-16 and external equipment.

- Initial setting: [Analog]
- Options: [Analog], [adat], or [SPDIF] (L=1~16, R=1~16)
- * You can set the mode for each Program individually.
- * The settings can be saved and loaded as part of the song data.
- * The settings are maintained after you turn off the power to the VF-16.

1. Select "Digital In" in the menu selection display and press the [ENTER/YES] key.
The items currently set will be shown in reversed white and black (In the initial state, "Analog" will be reversed in white and black).

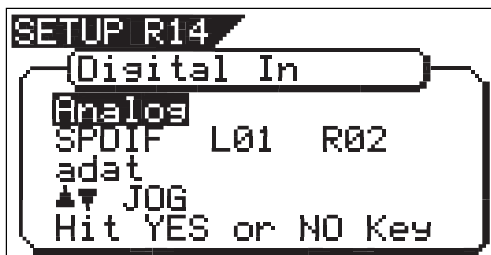

2. Select the desired "digital in" with the [JOG] dial.
Depending on the item selected, the following will be shown in the LCD.

AT SELECTION OF "SPDIF"

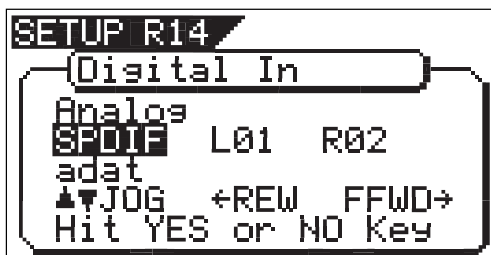

When in the initial setup and selecting "SPDIF," simultaneous with indicating that L of the S/P DIF digital signal is assigned to track 1 and that R to track 2, "-:REW F FWD:-" will also be shown.

This is indicating that any track can be selected for assigning to L/R. If the [REWIND] key or [F FWD] key is pressed, the blinking "L**" or "R**" will move. If the [JOG] dial is rotated, numbers 1 through 16 can be input at the blinking point.

When selecting "SPDIF," because S/P DIF digital signals can be assigned to any two tracks within 1 through 16, simultaneous recording of S/P DIF digital signal + analog signal is possible by input of analog signals into the other tracks (Refer to "Chapter 5 Features Applications" for details).

AT SELECTION OF "adat"

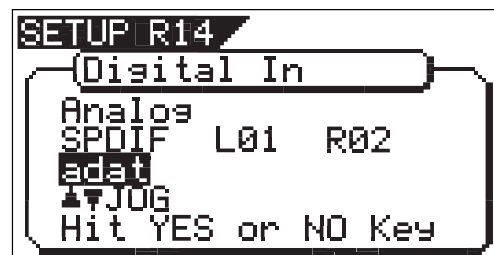

At selection of "adat," adat digital signals (1-8) only will be assigned to tracks 1-8 and analog signals can be input to tracks 9-16. As adat digital signals can be input to tracks 1-8 and analog signals into tracks 9-16 by using this feature, simultaneous recording of analog/digital 16 tracks can be realized. For details, refer to "Chapter 5 Features Applications."

3. Select the desired "digital in" and press the [ENTER/YES] key.
The selected "digital in" will be setup.
4. Press the [EXIT/NO] key (or STOP key) to exit from the SETUP mode.

When a correct digital signal (adat or S/P DIF) is input from the external digital equipment and then VF-16 is locked to the input signal, "ADAT" or "SPDIF" will be lit in the normal display as shown below.

If this display blinks, it indicating that an incorrect digital signal is input to the VF-16. In such a case, check connections between any external equipment or the external equipment digital out setting.



Setting Digital Output ["Digital Out"]

In the "Setup of digital output" menu, the type of digital signal to be output to external digital equipment from the VF-16 DIGITAL/DATA OUT connector, can be setup.

By using this feature, digital signals recorded in VF-16 can be directly sent without conversion to external digital equipment (MD, DAT, adat, digital mixer).

<Important>

When outputting digital signals to external digital equipment, the external digital equipment sampling frequency must be set identical to that of the VF-16.

- Initial setting: [SPDIF]
- Options: [SPDIF] or [adat]
- * You can set the mode for each Program individually.
- * The settings can be saved and loaded as part of the song data.
- * The settings are maintained after you turn off the power to the VF-16.

1. Select "Digital Out" in the menu selection display and press the [ENTER/YES] key.
The current setting will flash. "SPDIF" will flash in the initial setting.

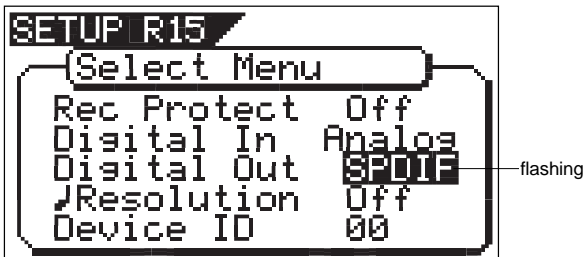

2. Select the desired "digital out" with the [JOG] dial.
Depending on the selected item, LCD will be as follows.

AT SELECTING OF "SPDIF" (initial setup)
When this setting is selected, STEREO BUSS L, R signals will be output as S/P DIF digital signals and should be selected at digital mixdown to a digital master recorder.

AT SELECTING OF "adat"
At selecting of "adat," signals from tracks 9-16 will be output as adat digital signals.
If signals from tracks 1-8 are to be output as adat digital signals, it must be executed after exchanging between tracks 1-8 and 9-16 by using the track exchange function (The same applies at output of data in the additional track).

3. Select the desired digital out and press the [ENTER/YES] key.
The selected digital out will be setup.
4. Press the [EXIT/NO] key (or STOP key) to exit from the SETUP mode.

Setting BAR/BEAT Resolution mode ["Resolution"]

The "Setting BAR/BEAT resolution mode" menu enables you to turn BAR/BEAT resolution mode on and off. The initial setting is "Off." When you turn this mode "On", the CLK (clock) digits will be always round off to "00" and be stored in the memory key while the VF-16 is using the BAR/BEAT/CLK time base.

That is, beat-resolution is used. Using this function allows you to automatically store a beat-resolution value of the CLIPBOARD IN/OUT points and other points in real-time. (Press the [STORE] key, then the corresponding memory key while playing the VF-16.) Therefore, it is very convenient when you perform the Copy & Paste or Move & Paste operation in beat-resolution.

For example, assume that you have stored the value for 001bar 1 46 clk as the CLIPBOARD IN point, and the value for 002bar 4 51 clk as the CLIPBOARD OUT point. These values will be used as they are if BAR/BEAT resolution mode is turned off. However, the mode is turned on, the following values will be stored instead. The following example has a time signature setting of 4/4.

- 001 bar 1 46 clk -> 001 bar 1 00 clk
(A clk value of 46 will be rounded off.)
- 002 bar 4 51 clk -> 003 bar 1 00 clk
(A clk value of 51 will be rounded up.)

- Initial setting: [Off]
- Options: [On] or [Off]
- * You can set the mode for each Program individually.
- * The settings can be saved and loaded as part of the song data.
- * The settings are maintained after you turn off the power to the VF-16.

1. Select "Resolution" in the menu selection display and press the [ENTER/YES] key.
The presently set item will be flash (On or Off).
"Off" will flash in the initial setup.

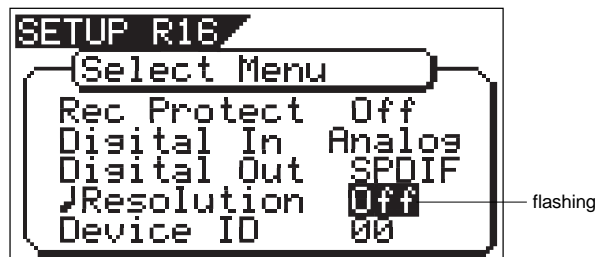

2. Select "On" or "Off" with the [JOG] dial and press the [ENTER/YES] key.
3. Press the [EXIT/NO] key (or STOP key) to exit from the SETUP mode.

Setting the MIDI device number ["Device ID"]

The "Setting the MIDI device number" menu enables you to set the VF-16 device ID number required to control the VF-16 from a sequence software using MMC (MIDI Machine Control).

The transmit device ID links to this setting. You can set the device ID from 00 to 99.

However, if the device ID number of the message the VF-16 receives is [7F], the VF-16 will recognize it to perform the corresponding operation, regardless of its device ID setting.

- Initial setting: [00]
- Options: [00] ~ [99]
- * You can set the mode for each Program individually.
- * The settings can be saved and loaded as part of the song data.
- * The settings are maintained after you turn off the power to the VF-16.

2. Select desired device number with the [JOG] dial and press the [ENTER/YES] key.
3. Press the [EXIT/NO] key (or STOP key) to exit from the SETUP mode.

1. Select "Device ID" in the menu selection display and press the [ENTER/YES] key.

The presently device number will be flash.
"00" will flash in the initial setup.

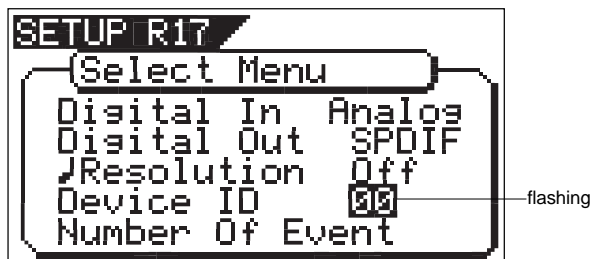

Checking the number of track events ["Number Of Event"]

The "Checking the number of track events" menu enables you to check the number of events on each track. Each track (including Additional tracks) of VF-16 Programs consists of consecutive audio files (and "zero" files). The number of events represents the total number of audio files and 0 files. Each track can contain up to 512 events.

If you are editing a song of typical length (about six minutes), repeated editing operation does not usually exceed this maximum number. (Exceeding this limit is called "event number overflow.") Even a 20-minute song will not cause event number overflow. This is because the recorder system always optimizes the data structure by keeping the number of events low. However, if a recording on a track is scattered in different areas of the disk, or if you have made a very long recording on a single track and performed many edits, you should be wary of "event number overflow." To avoid this problem, use the "Checking the number of track events" menu to check the number of events on each track prior to recording or editing.

1. Select "Number of Event" in the menu a selection display and press the [ENTER/YES] key.
It will change to the "Event" second level and the event number currently in each track will be displayed (The * symbol indicates there is data below). *** is the event number.
2. Use the [JOG] dial to select another (01~24) to check the number of events on the corresponding track.
3. Press the [EXIT/NO] key (or [STOP] key) to exit from the SETUP mode.

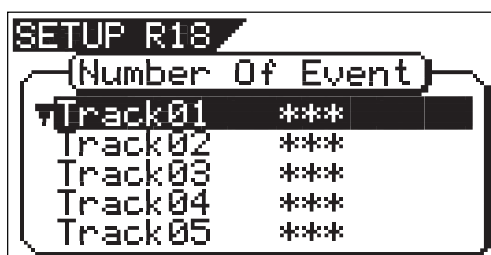

The Drive Format Information ["Drive Information"]

Format information of the current drive currently installed can be checked by using the "Drive Format Information" menu. Should any trouble occur in the VF-16, providing the information obtained here to our nearest Fostex Service Station will be of great help in giving quick service. The following items will be displayed and can be confirmed.

1. Manufacture / Model of the currently installed hard disk.
2. Format method
3. Format type
4. Simultaneously recordable number of tracks
5. Number of bits at formatting
6. Sampling frequency at formatting
7. Present number of programs
8. Present number of free blocks
9. Audio file / maximum number of events and its program No.
10. Specific capacity of the drive
11. Remaining capacity of the drive
12. Present software version

1. Select "Drive Information" in the menu selection display and press the [ENTER/YES] key. It will change to the "Drive Information" second level and the current drive information currently in use will be displayed (The ▼ symbol indicates there is data below).

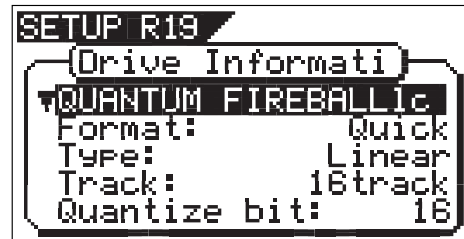

2. As the [JOG] dial is rotated, information will be displayed one by one.
3. Press the [EXIT/NO] key (or [STOP] key) to exit from the SETUP mode.

Drive Setting ["Drive Sel"]

In this "Drive Setting," a switch is made between the current drive (E-IDE hard disk) and the backup drive (Removable SCSI drive). The saved song data can be played back by switching to the backup drive (SCSI). However, this will be only to the extent of confirming the saved data and should all 16 channels be played back, it may create drop out of sound, and in some SCSI equipment, the channel possible for playback could be changed.

<Note>

The following operations cannot be executed when the drive is switched to "backup drive."

- * Save/load of song data
- * Recording
- * Creating a new program
- * Deleting a program
- * Copy & paste and Move & paste
- * Erase
- * Track exchange
- * Setup of tempo
- * ON/OFF of metronome function
- * Setup of permission or denial of recording
- * Setup of time signature
- * Editing a title

If power to the VF-16 is switched again, the drive will automatically switch to current drive (E-IDE).

In order to take out the removable disk when set to backup drive, press the [EXIT/NO] key while holding down the [SHIFT] key.

- Initial setting: [IDE]
- Options: [IDE] or [SCSI]
- * You can set the value for each Program individually.
- * The settings cannot be saved and loaded as part of the song data.

The selected drive will be set.

"IDE" indicates the 3.5-inch E-IDE hard disk and, "SCSI" the backup SCSI drive

1. Select "Drive Sel" in the menu selecting display and press the [ENTER/YES] key. The present setting will flash. "IDE" will be flashed in the initial setting.

3. Press the [EXIT/NO] key (or [STOP] key) to exit from the SETUP mode.

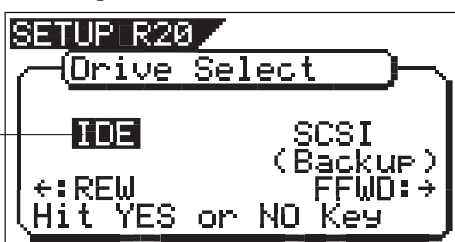

When the drive is changed, the program number in the normal display will shown as indicated below.

When the current drive is E-IDE (program display "P").



When the current drive is SCSI (program display "B").



2. Press the [REWIND] key/[F FWD] key, select "IDE" or "SCSI" and press the [ENTER/YES] key.

Fader Fix Mode Setting ["Fader Fix"]

Whether the fader manipulation should be reflected on the sound volume or not can be set.

The setup content will be held even if the main power is switched off.

<Caution>

The "Fader Fix Mode" can be made to function when set in other (CH, MST or CH & MST) than "Off" of the next item on the "Fader Recall Mode".

- Initial setting: [Off]
- Options: [On] or [Off]
- * You can set the value for each Program individually.
- * The settings cannot be saved and loaded as part of the song data.
- * The settings are maintained after you turn off the power to the VF-16.

1. Select "Fader Fix" in the menu selection display and press the [ENTER/YES] key.
The currently set will flash. "Off" will flash in the initial setting.

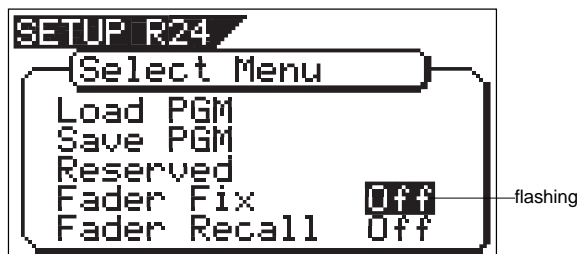

2. Select the desired item with the [JOG] dial and press the [ENTER/YES] key.
The selected item will be set.

On	For all modes, manipulation of the Channel fader/Master fader will have not affect on the sound volume. Any accidental shifting of the fader position by vibration and misoperation can be prevented.
Off (Initial setting)	Manipulation of the Channel fader/Master fader will affect the sound volume.

3. Press the [EXIT/NO] key (or [STOP] key) to exit from the SETUP mode.

Fader Recall Mode Setting ["Fader Recall"]

In the "Setup of the fader recall mode" menu, whether each channel input fader/master fader settings should be recalled or not at scene recall, can be setup.

- Initial setting: [Off]
- Options: [Off], [CH], [MST] or [CH & MST]
- * You can set the value for each Program individually.
- * The settings cannot be saved and loaded as part of the song data.
- * The settings are maintained after you turn off the power to the VF-16.

1. Select "Fader Recall" in the menu a selection display and press the [ENTER/YES] key.
The currently set will flash. "Off" will flash in the initial setting.

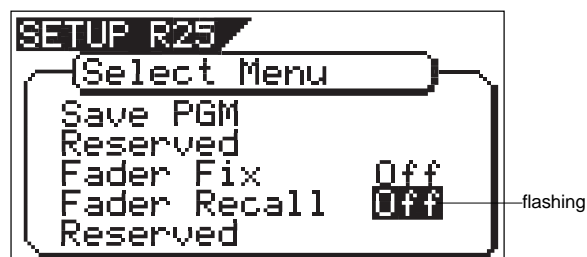

2. Input the desired item with the [JOG] dial and press the [ENTER/YES] key.
The selected item will be set.

Off (Initial setting)	When scene is recalled, the fader position immediately prior to recalling the scene will be directly employed without recalling the setup figures of each channel fader and the master fader.
CH (Channel)	When scene is recalled, setup figures of each channel faders only will be recalled and not recall the master fader setup figure.
MST (Master)	When scene is recalled, the setup figure of the master fader only is recalled and the channel fader setup figures will not be recalled.
CH & MST	When scene is recalled, each channel faders and the master fader set up figures will both be recalled.

3. Press the [EXIT/NO] key (or [STOP] key) to exit from the SETUP mode.

On/Off of phantom power setting ["Phantom Power"]

ON/OFF of phantom power provided at INPUT 7 and 8 (XLR-3-31) can be setup.

- Initial setting: [Off]
- Options: [On] or [Off]
- * You can set the value for each Program individually.
- * The settings cannot be saved and loaded as part of the song data.
- * The settings are maintained after you turn off the power to the VF-16.

<CAUTION!>

- Do the following before using the phantom power:
- * When connecting a condenser microphone to MIC INPUT 7 and 8 (XLR-3-31 type) of the VF-16, be sure this microphone requires phantom power (+48V).
 - * Switch ON the phantom power after connecting the condenser microphone.
 - * Always mute the VF-16 output when switching ON-OFF the phantom power and when connecting or disconnecting the microphone cable from the VF-16.
 - * Always switch OFF the phantom power when connecting a dynamic microphone to INPUT 7 and 8 (XLR-3-31 type). Otherwise, a malfunction could occur.

Phantom power cannot be used with the following equipment:

- * Unbalanced output microphones.
- * High impedance microphones.
- * In a microphone where there is voltage leak between pin 2/pin 3 and pin 1 of the microphone cable canon connector.
- * Old model ribbon microphones of the ground center tap output type.

1. Select "Phantom Power" in the menu selection display and press the [ENTER/YES] key.

The currently set will flash. "Off" will flash in the initial setting.

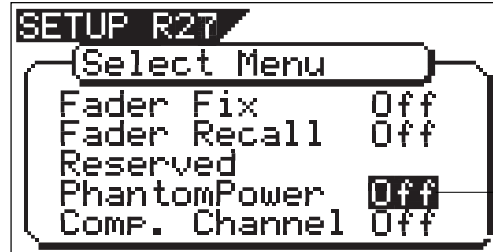

flashing

2. Select the desired item with the [JOG] dial and press the [ENTER/YES] key.

The selected item will be set.

Off (Initial setting)	Phantom power will not be supplied.
On	Phantom power is supplied to INPUT 7 and 8. The PHANTOM LED will be lit.

3. Press the [EXIT/NO] key (or [STOP] key) to exit from the SETUP mode.

Compressor Channel Setting ["Comp. Channel"]

In the "Setup of the compressor channel" menu, the channel in which the VF-16 internal compressor function should be activated can be setup. The compressor can be made to function in channels 13-14 or 15-16. Regardless to this setting, the compressor can be applied at all times to the master channel.

<Note>

The VF-16 internal compressor can be made to function only in the channel setup here and the master channel. However, editing of EQ in channels other than the master channel, is not permissible.

- * Initial setting: [Off]
- * Options: [Off], [13-14] or [15-16]
- # Common to all programs in the same disc.
- # The setup content cannot be saved/loaded as song data.
- # Although the setup content will not be held at switch off of power, it can be saved as a scene memory.

1. Select "Comp. Channel" in the menu selection display and press the [ENTER/YES] key. The currently set will flash. "Off" will flash in the initial setting.

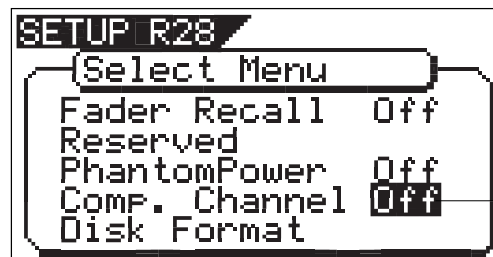

flashing

2. Select the desired comp. Channel with the [JOG] dial and press the [ENTER/YES] key.

The selected item will be set.

Off (Initial setting)	Compressor can be applied only in the master channel.
13-14	The compressor can be applied to channels 13/14 and the master channel.
15-16	The compressor can be applied to channels 15/16 and the master channel.

3. Press the [EXIT/NO] key (or [STOP] key) to exit from the SETUP mode.

<Important>

EQ cannot be applied to the channel (Except the master channel) setup for the compressor.

With the compressor channel setup, if the EQ editing mode is entered, this condition will be indicated by the [CH STATUS/CH SEL] key LED.

The channel in which the LED (green) is blinking is an indication that EQ editing is possible in this channel and the channel in which the LED is not lit is an indication that EQ cannot be applied to this channel.

If a channel that cannot be EQ editing had been selected, the "Can't Select!" message will blink to warn that the operation is ineffective.

The schematic below is an example of channels 15-16 setup as the compressor channel.

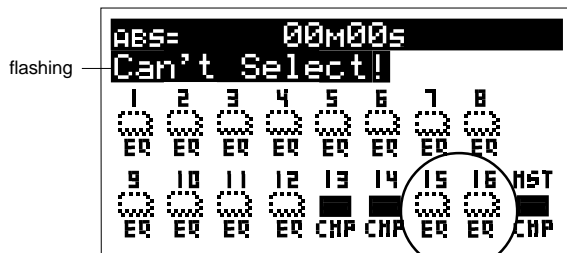

This is indicating that channels 15 and 16 are setup as the compressor channel.

Trouble Shooting

A breakdown? If you suspect so, please read the following explanations before requesting repairs.

Troubles at Recording?

- * Input signal not indicated by the level meter ?
Level meter does not light up even though recording track is set and channel fader/master fader is raised to the "0" position.

Set the recorder to input monitor

Press the [RECORD] key only. The key will blink in red and the READY track will be in the input monitor mode. The recorder output can be applied to each channel faders. The level meter is unable to function unless the READY track is changed to the input monitor mode. For details, read pages 28 and 38.



- * Level does not increase even though the channel fader is raised ?
Recording level will not increase although the READY track channel fader is raised to maximum (+6).

Adjust [TRIM] knob to a suitable level

The level cannot be raised for small input signals if the [TRIM] knob is positioned at "LINE" (full CCW). Rotate the [TRIM] knob to just before the sound distorts.



- * The monitor sound is not heard even though the input level/stereo buss L, R levels are being indicated by the meter ?
Although the READY track is set to input monitor, no sound is heard in the headphone although the meter is indicating the level.

Raise the [PHONES] knob

No sound will be heard if the headphones adjuster is turned down. Also, if monitoring with an external monitor speaker, raise the [MON OUT] knob.

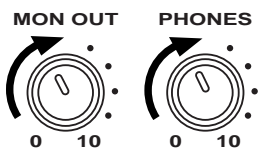

- * When attempting to select a recording track for DIRECT recording, are there some tracks between 9-16 that cannot be selected ?

Could there be some channels set to [INPUT] at setup of [INPUT]-[TRACK] ?

DIRECT recording is executed, basically, with all channels in the [TRK] mode at setup of [INPUT]-[TRACK], as shown below. Should any one channel of 9-16 is set to [INPUT], that channel cannot be set as a recording track at DIRECT recording.

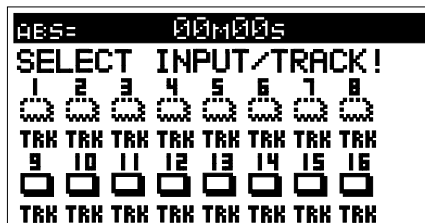

- * Sound adjusted by EQ cannot be recorded by DIRECT recording ?

When DIRECT recording, EQ cannot be applied

Application of EQ at recording is permissible only at BUSS recording. Although EQ can be applied to the input signal at DIRECT recording, this is strictly listening to the monitor sound only and the original sound will be recorded without alteration. However, when BUSS recording, EQ can be applied to each input signal and recorded.

- * Effect sound cannot be recorded at BUSS recording ?

Select source channel for the effect

When BUSS recording, in order to record while applying effect to the source channel, effect 1 or effect 2 must be selected together with selecting the source channel as shown in the schematic below. In the example below, input H and effect 1 are selected for the source channel. For details, read page 38.

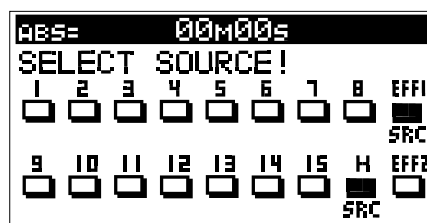

- * Even though effect is selected for the source channel, effect cannot be applied ?

Raise the effect send level

Initially, the effect send level of each channel will all be at "0".

Select the channel for applying effect and raise the effect send level with the JOG dial. For details, read page 44.

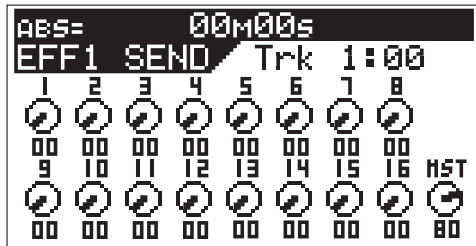

- * Ping pong recording cannot be executed ?

Is the playback track for ping pong set to source channel

Press the [BUSS-SOURCE] key and set the track for ping pong to source channel.

Then, press the [BUSS-REC TRK] key and set the ping pong objective track in the READY mode.

In the example below, tracks 1-4 and 9-12 are selected for the source channel and their signals sent for ping pong into tracks 15 and 16.

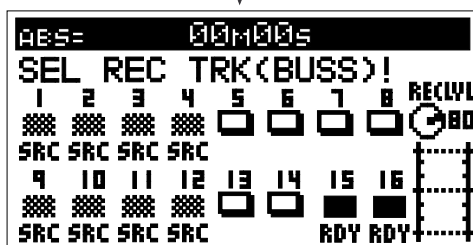
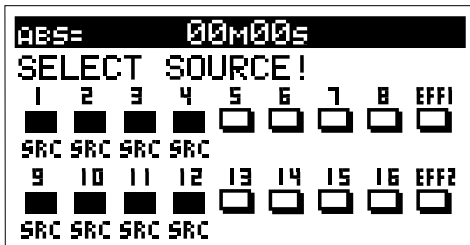

- * Cannot record external digital signals ?

Match "Digital In" in the SETUP mode to the digital signal (S/P DIF or adat) to be input
Read page 107 for details.

- * Cannot record analog signals ?

Could the track about to be recorded still be set for digital inputs

Analog signals cannot be recorded in a track set for digital input by "Digital In" in the SETUP mode.
Reset the digital input to "Analog."

- * At playback of digital signals just recorded, sound pitch is not normal ?

Record digital signals of sampling frequency identical to that of the VF-16

The VF-16 sampling frequency is 44.1kHz/16 bit. In a sampling frequency other than 44.1kHz/16 bit, it will be recorded with the wrong pitch. Time count will also be incorrect.

Having trouble Editing?

- * A warning message appears although it was only execution of copy-clip (or move-clip) ?

Correctly register the CLIPBOARD IN and OUT points

The relation between CLIPBOARD IN point and OUT point is "IN point<OUT point".

If it is registered in reverse relationship, copy-clip (or move-clip) cannot be executed.

- * When copy paste (or move paste) is executed, the sound section located before head of the bar is missing ?

Use the ALIGN SEL function

If the "ALIGN SEL" function is used at executing copy paste (or move paste), the sound section located in front of the bar head can be included at pasting.
Refer to page 65 for details.

MIDI Implementation Chart

(Digital Multitracker)

Model VF-16

MIDI Implementation Chart

Date:
Version: V1.00

Function.....	Transmitted	Recognized	Remarks
Basic Default Channel Changed	X X	X X	
Mode Default Message Altered	X X *****	X X X	
Note Number: True Voice	X *****	X X	
Velocity Note ON Note OFF	X X	X X	
After Touch Key's Channel's	X X	X X	
Pitch Bend	X	X	
Control Change	X	X	
Program Change True #	X *****	X X	
System Exclusive	○ (rem. 1)	○ (rem. 2)	
Common : Quarter Frame : Song Position : Song Select : Tune	○ ○ X X	○ X X X	
System : Clock Real Time : Commands	○ ○ (rem. 3)	X X	
Aux. Message : Local ON/OFF : All Notes OFF : Active Sense : Reset	X X X X	X X X X	
Notes	rem.1: MMC (Device ID=00~99, 127), MTC, Identity reply rem.2: MMC (Device ID=00~99, 127), MTC, Inquiry rem.3: START, STOP, CONTINUE		

Mode 1: OMNI ON, POLY
Mode 3: OMNI OFF, POLY

Mode 2: OMNI ON, MONO
Mode 4: OMNI OFF, MONO

○ : Yes
X : No

MMC Command List

Command list	Movement (Recorder)
01: STOP	STOP
02: PLAY	PLAY
03: DEFERRED PLAY	DEFERRED PLAY
04: FAST FORWARD	F FWD
05: REWIND	REWIND
06: RECORD STROBE	REC
07: RECORD EXIT	PUNCH OUT
09: PAUSE	STOP
40: WRITE	Refer to MMC Response/Information Field List
41: MASKED WRITE	Refer to MMC Response/Information Field List
42: READ	Refer to MMC Response/Information Field List
44: LOCATE	LOCATE to Setting Data
46: SEARCH	CUE/REVIEW (+/- 1~60 times)
47: SHUTTLE	CUE/REVIEW (+/- 1~60 times)
4C: MOVE	Refer to MMC Response/Information Field List
4D: ADD	Refer to MMC Response/Information Field List
4E: SUBTRACT	Refer to MMC Response/Information Field List

MMC Response/Information Field List	Command
01: SELECTED TIME CODE	READ/WRITE/MOVE/ADD/SUBTRACT
03: REQUESTED OFFSET	READ/WRITE
04: ACTUAL OFFSET	READ
08: GP 0	READ/WRITE/MOVE/ADD/SUBTRACT
09: GP 1	READ/WRITE/MOVE/ADD/SUBTRACT
0A: GP 2	READ/WRITE/MOVE/ADD/SUBTRACT
0B: GP 3	READ/WRITE/MOVE/ADD/SUBTRACT
0C: GP 4	READ/WRITE/MOVE/ADD/SUBTRACT
0D: GP 5	READ/WRITE/MOVE/ADD/SUBTRACT
0E: GP 6	READ/WRITE/MOVE/ADD/SUBTRACT
0F: GP 7	READ/WRITE/MOVE/ADD/SUBTRACT
48: MOTION CONTROL TALLY	READ
4C: RECORD MODE	READ/WRITE
4E: TRACK RECORD STATUS	READ
4F: TRACK RECORD READY	READ/WRITE/MASKED WRITE
51: RECORD MONITOR	READ/WRITE

Inquiry Message List

IDENTITY REQUEST: F0, 7E, <channel>, 06, 01, F7
 IDENTITY REPLY: F0, 7E, <channel>, 06, 02, 51, 01, 00, 13, 00, **, **, **, **, F7

51 :Fostex ID
 01, 00 :Device family code
 13, 00 :Device family number VF-16
 **, **, **, ** :Software version

Maintenance

Cleaning the exterior

** For normal cleaning, use a soft dry cloth.*

For stubborn dirt, moisten a cloth in diluted detergent, wring it out firmly, and wipe the dirt off. Then polish with a dry cloth. Never use solvents such as alcohol, thinner or benzene, since these will damage the printing and finish of the exterior.

Specifications

Recording/Reproducing

Recording Medium	: 3.5 inch, hard disk (E-IDE type)
Recording Format	: FDMS-3 (*)
Save/Load Format	: FDIO-1 (**)
Sampling Frequency	: 44.1kHz
Quantization	: 16-bit linear (Non expanded)
A/D Converter	: 20-bit 64 times, over sampling, Delta-Sigma
D/A Converter	: 24-bit 128 times, over sampling, Delta-Sigma
No. of Recording Track	: 16 real tracks + 8 additional tracks *16 tracks for simultaneous recording
Vari Pitch Control	: +/- 6%
Crossfade	: 10msec.
Recording/Reproducing Frequency	: 20Hz ~ 20kHz

Input/Output

Input 1 ~ 6

Connector	: ϕ 6mm Phone jack (Unbalanced)
Input Impedance	: 50k Ω or more (Unbalanced)
Standard Input Level	: -50dBV ~ 2dBV

Input 7 and 8

Connector	: ϕ 6mm Phone jack (Unbalanced)
	: XLR-3-31 type (Balanced)
Input Impedance	: 50k Ω or more (Unbalanced), 10k Ω or more (Balanced)
Standard Input Level	: -50dBV ~ 2dBV
Phantom Power (XLR only)	: +48VDC (Setting of ON/OFF with SETUP mode)
Output (Tip)	
Load Impedance	: 10k Ω or more
Input Level	: -10dBV

INSERT Input/Output

Connector	: ϕ 6mm TRS Phone jack
Output (Tip)	
Load Impedance	: 10k Ω or more
Input Level	: -10dBV
Input (Ring)	
Load Impedance	: 10k Ω or more
Output Level	: -10dBV

MONITOR Output

Connector	: ϕ 6mm Phone jack (Unbalanced)
Load Impedance	: 10k Ω or more
Output Level	: -10dBV

HEADPHONE

Connector	: ϕ 6mm TRS Phone jack
Load Impedance	: 10 Ω ~ 50 Ω
Output Level	: 20mW or more (at 16 Ω)

AUX SEND 1 and 2

Connector	: ϕ 6mm TRS Phone jack (Tip: SEND1, Ring: SEND2)
Load Impedance	: 10k Ω or more

Output Level	: -10dBV
STEREO OUT L, R	
Connector	: RCA pin jack
Load Impedance	: 10k Ω or more
Output Level	: -10dBV
DIGITAL IN	
Connector	: Optical
Format	: (1) IEC 60958 (S/P DIF), (2) Alesis Proprietary Multi Channel Optical Interface (Either (1) or (2) is selected in the SETUP mode)
DIGITAL OUT	
Connector	: Optical
Format	: (1) IEC 60958 (S/P DIF), (2) Alesis Proprietary Multi Channel Optical Interface (Either (1) or (2) is selected in the SETUP mode)
MIDI IN/OUT	
Connector	: DIN 5 PIN
PUNCH IN/OUT	
Connector	: \varnothing 6mm Phone jack (An optional FOOT SW Model 8051 can be connected.)
SCSI (for use Backup)	
Connector	: D-sub half pitch 25pin
General	
Connector	: 380 (W) x 98 (H) x 335 (D) mm
Weight	: Approx. 4.0kg
Power Supply	: 120VAC 60Hz, 230V~ 50/60Hz (AC inlet type)
Power Consumption	: 20W
Accessories	
	: Owner's manual
	: Power Cable

* Fostex Disk Management System-3

** Fostex Data In Out-1

Specifications and appearance are subject to change without notice for product improvement.

"Adat" an the  symbol are trademarks of Alesis Corporation.

Block Diagram

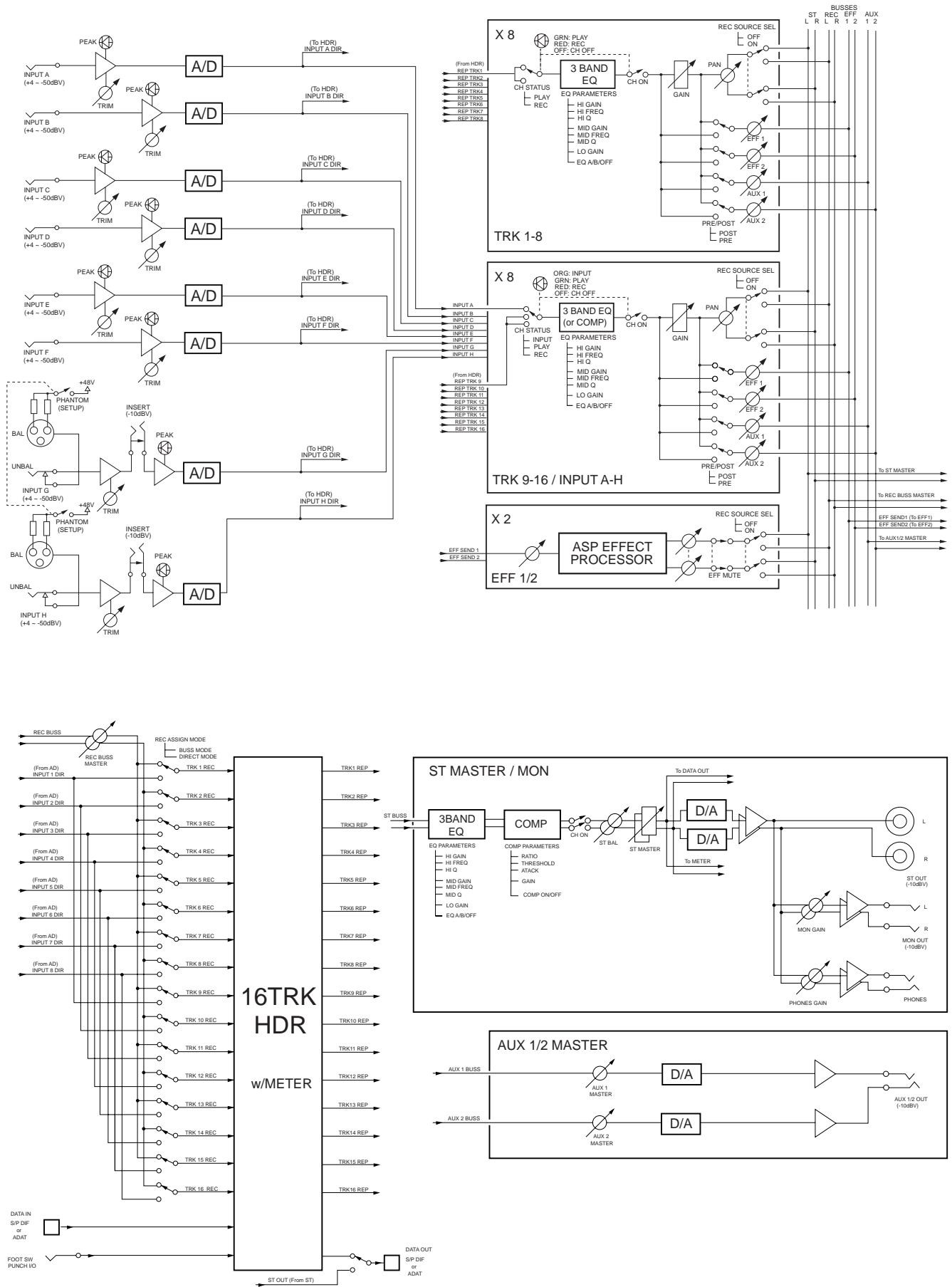

Declaration of EC Directive

This equipment is compatible with the EMC Directive (89/336/EEC) - Directive on approximation of member nation's ordinance concerning the electromagnetic compatibility and with the Low Voltage Directive (73/23/EEC) - Directive on approximation of member nation's ordinance concerning electric equipment designed to be used within the specified voltage range.

The Affect of Immunity on This Equipment

The affect of the European Specification EN50082-1 (coexistence of electromagnetic waves - common immunity specification) on this equipment are as shown below.

* In the electrical fast transient/burst requirements, surge, conducted disturbances by radio-frequency fields, power frequency magnetic field, radiate electromagnetic field requirements and static electricity discharging environment, this could be affected by generation of noise in some cases.

FOSTEX DISTRIBUTORS LIST IN EUROPE

* Including non-EU countries.

* underlined: contracted distributors (as of April, 1999)

<AUSTRIA>

NAME: A TEC Audio-u. Videogeraete VertriebsgesmbH.
ADD: Im Winkel 5, A-2325 Velm, Austria
TEL: (+43) 2234-74004, FAX: (+43) 2234-74074

<BELGIUM>

NAME: EML Sound Industries NV
ADD: Bijvennestraat 1A, B3500 Hasselt, Belgium
TEL: (+32) 11-232355, FAX: (+32) 11-232172

<DENMARK>

NAME: SC Sound ApS
ADD: Malervej 2, DK-2630 Taastrup, Denmark
TEL: (+45) 4399-8877, FAX: (+45) 4399-8077

<FINLAND>

NAME: Noretron Oy Audio
ADD: P. O. Box 22, FIN-02631 Espoo, Finland
TEL: (+358) 9-5259330, FAX: (+358) 9-52593352

<FRANCE>

NAME: Musikengro
ADD: ZAC de Follhouses, B. P. 609, 01706 Les Echets, France
TEL: (+33) 472 26 27 00, FAX: (+33) 472 26 27 01

<GERMANY>

NAME: Studio sound & Music GmbH
ADD: Industriestrasse 20, D-35041 Marburg, F. R. Germany
TEL: (+49) 6421-92510, FAX: (+49) 6421-925119

<GREECE>

NAME: Bon Studio S. A.
ADD: 6 Zaimi Street, Exarchia, 106.83 Athens, Greece
TEL: (+30) 1-3809605-8, 3302059, FAX: (+30) 1-3845755

<ICELAND>

NAME: I. D. elrf. electronic Ltd.
ADD: ARMULA 38 108 REYKJAVIK, ICELAND
TEL: (+354) 588 5010, FAX: (+354) 588 5011

<ITALY>

NAME: Recoton Italia Srl.
ADD: V. 1 Maggio, N 18, 40050 Quarto Inferiore, (BO) Italy
TEL: (+39) 051-768576, FAX: (+39) 051-768336

<THE NETHERLANDS>

NAME: IEMKE ROOS AUDIO B. V.
ADD: Kuiperbergweg 20, 1101 AG Amsterdam, The Netherlands
TEL: (+31) 20-697-2121, FAX: (+31) 20-697-4201

<NORWAY>

NAME: Siv. Ing. Benum A/S
ADD: P. O. Box 145 Vinderen, 0319 Oslo 3, Norway
TEL: (+47) 22-139900, FAX: (+47) 22-148259

<PORTUGAL>

NAME: Caius - Tecnologias Audio e Musica, Lda.
ADD: Rua de Santa Catarina, 131 4000 Porto, Portugal
TEL: (+351) 2-2086009/2001394,
FAX: (+351) 2-2054760/2087488

<SPAIN>

NAME: Multitracker, S. A.
ADD: C/Garcilaso No.9, Madrid 28010, Spain
TEL: (+34) 91-4470700, 91-4470898, FAX: (+34) 91-5930716

<SWEDEN>

NAME: Professional Television AB
ADD: Kavallerivagen 24, 172 48 Sundbyberg, Sweden
TEL: (+46) 8-59798000, FAX: (+46) 8-59798001

<SWITZERLAND>

NAME: Audio Bauer Pro AG
ADD: Bernerstrasse-Nord 182, CH-8064 Zurich, Switzerland
TEL: (+41) 1-4323230, FAX: (+41) 1-4326558

<UK>

NAME: SCV London
ADD: 3A 6-24 Southgate Road, London N1 3JJ, England, UK
TEL: (+44) 171-923-1892, FAX: (+44) 171-241-3644

Fostex[®]

FOSTEX CORPORATION

3-2-35, Musashino, Akishima-shi, Tokyo, Japan 196-0021

FOSTEX CORPORATION OF AMERICA

15431, Blackburn Ave., Norwalk, CA 90650, U. S. A.