

VF160 Owner's Manual

<V2.0 Supplement>

This supplement describes the enhanced/new functionality of the VF160 version 2.0 software.

Before using the VF160 V2.0, please read this supplement along with the original owner's manual.

Newly added functionality:

- (1) Chain play function
- (2) Audio CD playback mode

Enhanced functionality:

- (1) Audio CD recording
- (2) Audio CD track loading

Table of Contents

Chain play function	5
Making the chain play list	6
Making the chain play list by selecting all the programs	7
Making the chain play list by selecting desired programs	8
Setting the chain play mode	9
Selecting a program in the chain play list	10
Editing the chain play list	11
Deleting (or replacing) a program in the chain play list	11
Deleting all programs from the chain play list	12
Inserting a program to the chain play list	13
 Changes in audio CD recording functionality	 14
Change in the automatic silence recording function between songs	14
Change in the CD-R/RW setup menu	14
How to make a silent space between songs in the mastering process	15
How to insert a silent space after completing mastering	15
How to edit the Clipboard Out point	16
Event enable/disable setting	17
 Newly added audio CD playback mode	 19
Switching the playback mode	19
Available functions in the audio CD playback mode	20
 Function enhancement on audio CD track loading	 22
How to load tracks from an audio CD	22

<Before using, please attach the sticker!>

In the VF160 V2.0 carton, you can find a sticker labeled "CD PLAY", as well as the owner's manual and V2.0 supplement (this document), etc.

This sticker should be attached to the position under the [SCRUB] key for indicating that this key is used for audio CD playback.

Attach the sticker as shown in the illustration below (indicated by the arrow).

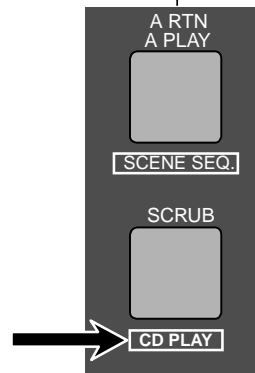
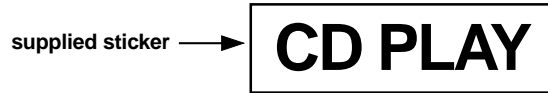

Chain play function

The chain play function allows you to play back programs in order according to the “chain play list”.

As examples in figure 1, you can play back programs in order of program number or in desired order.

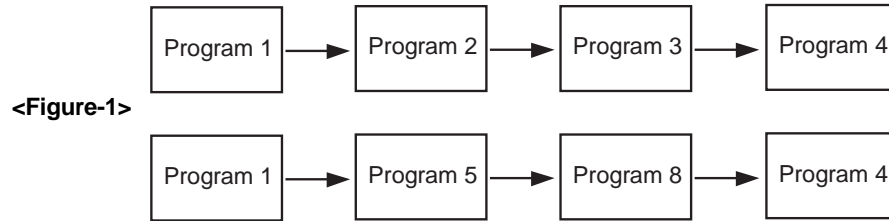

You can play the whole (i.e. from ABS 0 to REC END) of each program in the chain play list as shown in figure 2, as well as a desired part(*) of each program as shown in figure 3.

(*) A desired part can be specified as a range between the Auto Return Start and Auto Return End points. Therefore, if a program does not have both the Auto Return Start and End points which are correctly set, the whole program (from ABS 0 to REC END) is played back. See page 35 of the owner's manual for details about how to set the Auto Return Start and End points.

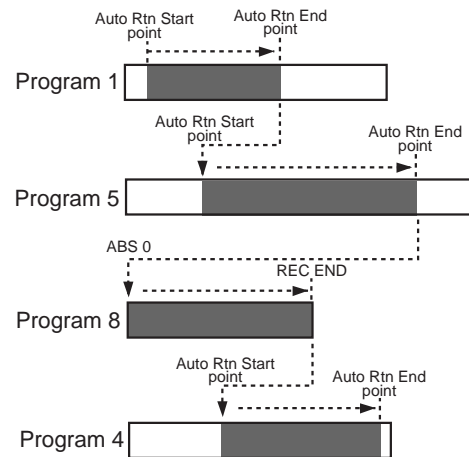
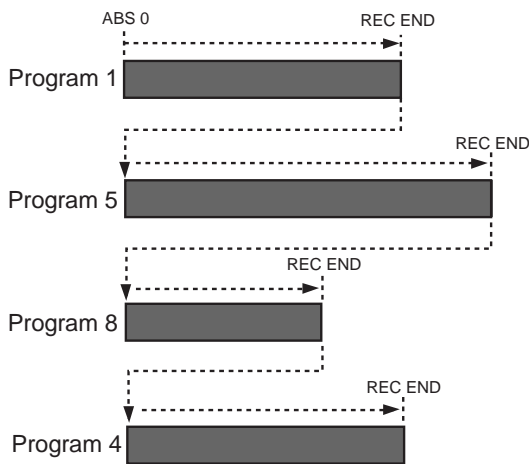

In addition, you can select a playback mode for the chain play function from among “Pause”, “A. Play” and “Repeat” (see below for details about each mode).

Pause	In this mode, the VF160 plays back each program in the chain play list one by one. Each time the VF160 finishes playback of a program, it automatically pauses at the start point of the next program. Pressing the [PLAY] key starts playback.
A. Play	In this mode, the VF160 plays back all programs in the chain play list continuously. After finishing playback of the last program, the VF160 pauses at the start point of the first program. Pressing the [PLAY] key again starts playback of all programs in the chain play list continuously.
Repeat	In this mode, the VF160 plays back all programs in the chain play list continuously and repeatedly until you press the [STOP] key.

Making the chain play list

Before executing chain play, you must make the chain play list by selecting the desired (or all) programs in the desired order. You can enter up to 99 programs to the chain play list.

On pages 7 and 8, two procedure examples for entering programs on the VF160 current drive to the list are shown. The former example shows how to enter all programs on the current drive, while the latter shows how to enter desired programs. Both examples assume that 10 programs exist on the current drive.

- 1) **While the VF160 is stopped, press the [SETUP] key.**

The VF160 enters the setup mode and the display changes to show the "Select Menu" screen for selecting a setup menu item.

By default, the "Signature Set" flashes as shown in the figure below.

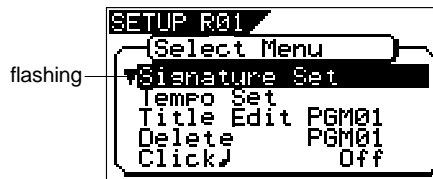

- 2) **Use the [JOG] dial to select "Chain Play List" which is the 23rd menu item (R23) in the setup menu, and then press the [ENTER/YES] key.**

The display changes to show the "Chain Play List" screen, in which "C01:END" is highlighted by default. "C01" shows the step number, while "END" shows no program is entered to the chain play list.

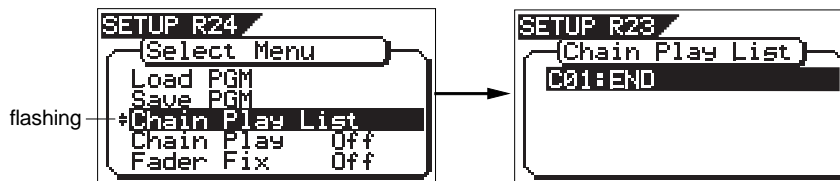

- 3) **Press the [ENTER/YES] key again.**

"END" starts flashing and you can now enter a desired program to step 01.

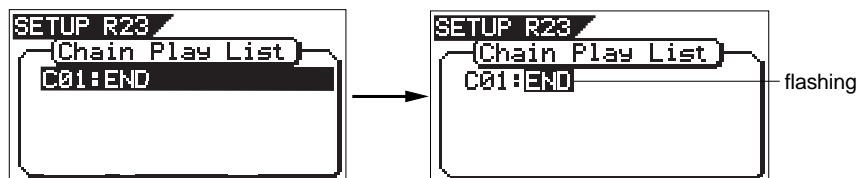

By rotating the [JOG] dial while "END" is flashing, you can select a desired option from among the programs on the drive ("P01" through "P10"), as well as "ALL", "INS" and "DEL". See the table below for details about each option.

END	The current and succeeding steps in the chain play list are all deleted. (See "Deleting all programs from the chain play list" described later for details.)
ALL	All programs on the current drive are entered to the chain play list. Note that you can select "ALL" to step 1 (C01) only. There is no "ALL" option on other steps. (See "Making the chain play list by selecting all the programs" described later for details.)
INS	A desired program can be added (inserted) to the current step. (See "Inserting a program to the chain play list" described later for details.)
DEL	The program on the current step is deleted. (See "Deleting a program from the chain play list" described later for details.)
P01 - Pnn	A desired program is entered to the current step. If another program is already entered, the new program overwrites it. You can select any of the programs on the current drive. (See "Making the chain play list by selecting desired programs" described later for details.)

Making the chain play list by selecting all the programs

The following procedure example shows how to enter all the programs (P01 through P10) on the current drive to the chain play list.

- 1) **While "END" is flashing, rotate the [JOG] dial to select "ALL", and press the [ENTER/YES] key.**

By rotating the [JOG] dial to the left, you can find "ALL" easily.

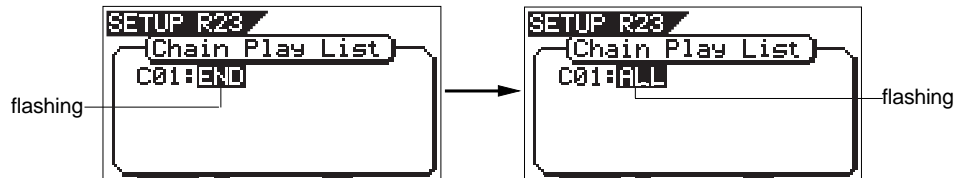

By pressing the [ENTER/YES] key after selecting "ALL", all programs on the current drive are entered to the chain play list, as shown in the screen example below.

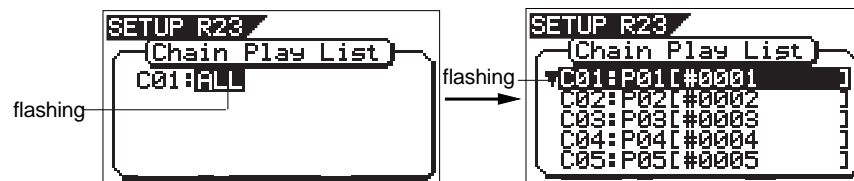

By rotating the [JOG] dial, you can scroll through the list to check the chain play list. In the last line on the list, "C11: END" is shown, which shows that no more program is entered after step 11.

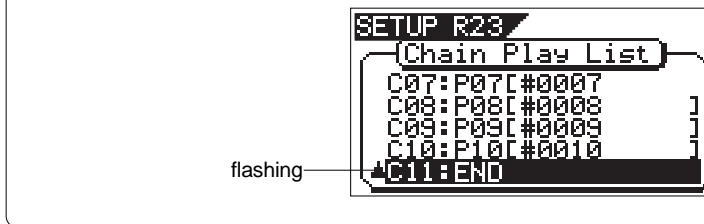

- 2) **Press the [EXIT/NO] key.**

The chain play list is made and the "Chain Play List" screen is dismissed.

The display returns to the "Select Menu" screen, where the current option of the "Chain Play" menu item flashes (by default, "Off" flashes) and you can now set the chain play mode.

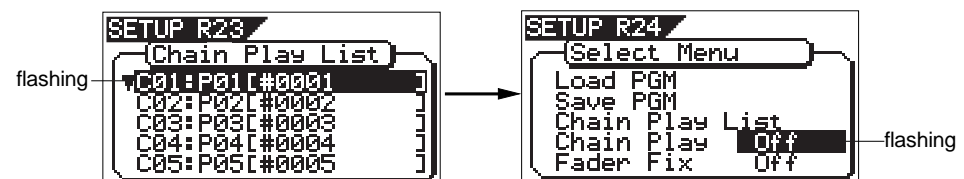

For details about how to set the chain play mode, see "Setting the chain play mode" on page 9.

<Note>

If a program which participates in the chain play list is deleted from the drive (see "Deleting a program" in the owner's manual), the whole play list is cleared (it returns to show "C01: END").

If you select the "Delete" menu item of the Setup mode and press the [ENTER/YES] key, the display shows the warning message ("[WARNING] Delete Play List too?").

Making the chain play list by selecting desired programs

The following procedure example shows how to enter the five desired programs (from among 10 programs on the current drive) to steps 1 through 5 in the chain play list, as below.

- : C01 -> program 5 (P05)
- : C02 -> program 3 (P03)
- : C03 -> program 1 (P01)
- : C04 -> program 2 (P02)
- : C05 -> program 4 (P04)

- 1) **While “END” is flashing on the screen, rotate the [JOG] dial to select “P05” and press the [ENTER/YES] key.**

You can select the desired program by rotating the [JOG] dial to the right. When selecting the program, the first nine characters of the program name is also shown (in the example below, the name is “#0005”).

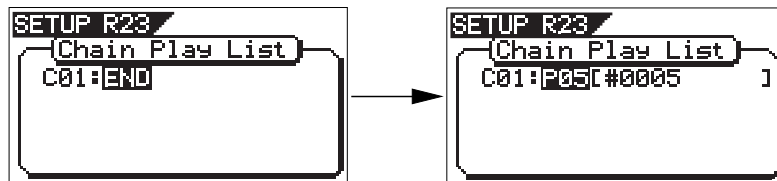

After selecting “P05” and pressing the [ENTER/YES] key, program 5 (P05) is set to step 1 (C01) of the chain play list and the screen changes as shown below.

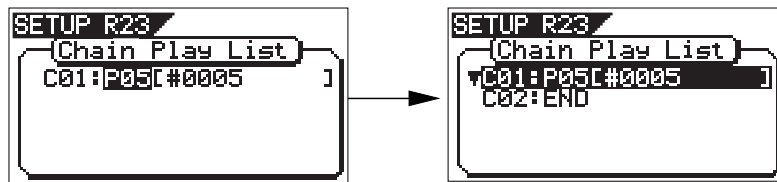

- 2) **Use the [JOG] dial to highlight “C02: END” and press the [ENTER/YES] key.**

As with procedure step 1) above, “END” of “C02: END” starts flashing.

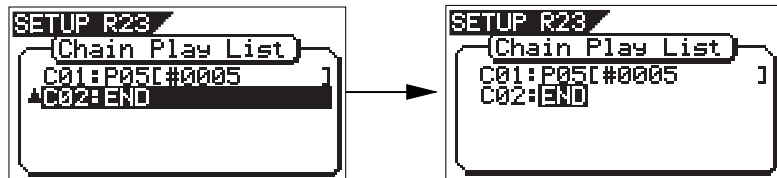

- 3) **While “END” is flashing on the screen, rotate the [JOG] dial to select “P03” and press the [ENTER/YES] key.**

As with procedure step 1) above, program 3 (P03) is set to step 2 (C02) of the chain play list and the screen changes as shown below.

Set programs to steps 3 through 5 (C03 through C05) of the chain play list with the same manner as above.

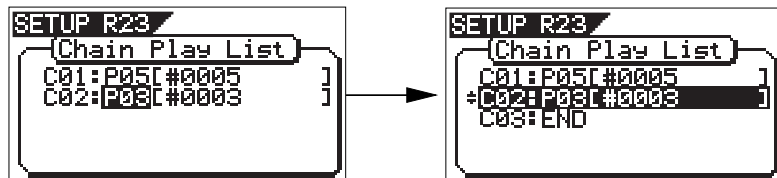

- 4) **After completing setting all the desired programs to the chain play list, press the [EXIT/NO] key.**

The chain play list is made and the “Chain Play List” screen is dismissed. The display returns to the “Select Menu” screen, where the current option of the “Chain Play” menu item flashes (by default, “Off” flashes) and you can now set the chain play mode.

For details about how to set the chain play mode, see “Setting the chain play mode” on page 9.

Setting the chain play mode

When you have made the chain play list, set the chain play mode.

The following procedure shows how to set the chain play mode after making the chain play list as described before.

- 1) While "OFF" which is the current option of the "Chain Play" mode setting is flashing on the screen, rotate the [JOG] dial to select a desired chain play mode option. You can select a chain play mode option from among "Pause", "A. Play" and "Repeat", besides "Off". See page 5 for details about each chain play mode option.

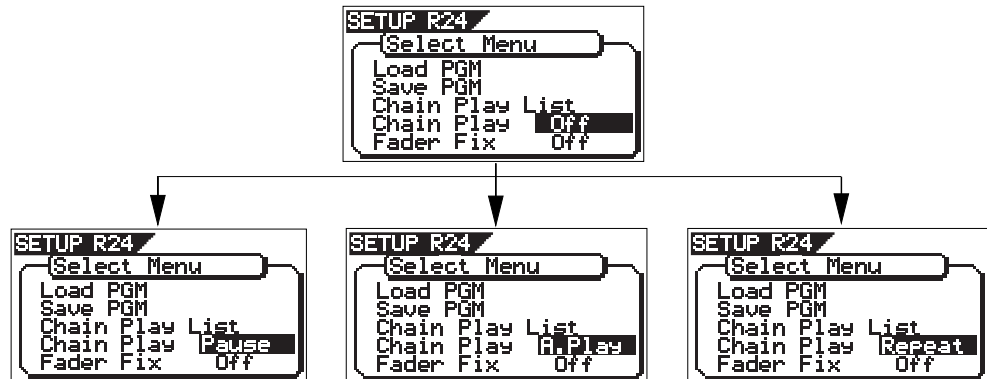

<Notes>

- The chain play mode setting returns to the default setting ("Off") when turning off the power or executing play list editing (described later). Therefore, each time you want to carry out chain play after turning on the power or executing play list editing, you must set the chain play mode.
- If you are going to set the chain play mode while the chain play list has not been made, "[WARNING] Illegal Play List!" is shown and the setting is invalid.

- 2) After selecting the desired option, press the [ENTER/YES] key.

The VF160 enters the selected play mode, while the Setup mode exits. The display shows the beginning (ABS 0, or the Auto Return Start point) of the program set to step 1 in the play list. In this condition, pressing the [PLAY] key starts playback of the play list by the selected play mode (if the play mode is set to "A. Play" or "Repeat", playback starts automatically).

The current play mode is shown for a few seconds after starting playback, as shown in the right example below (in this example, the play mode is set to Auto Play).

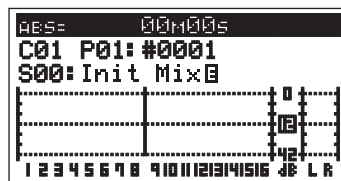

The normal screen example when setting the play mode

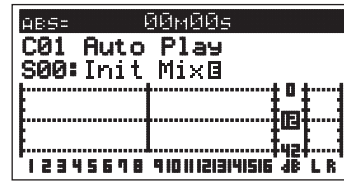

The example of the play mode display

<Notes when the chain play mode is set to any option but "Off">

- When the chain play mode is set to any option but "Off", you cannot make the auto punch mode or auto function mode active. If you are going to make either of them active, "[WARNING] Void! Chain Play" is shown and the operation is invalid.
- When setting the chain play mode to "Repeat" and exiting the setup mode, the recorder automatically starts playback from the start point (the ABS 0 or Auto Return Start point) of the first program in the chain list. (When setting the chain play mode to "Pause" or "A. Play" and exiting the setup mode, the recorder moves to the beginning of the first program in the chain list.)
- When the chain play mode is set to any option but "Off", you can change the current program (by [PGM SEL] key) only from among the programs set to the chain play list (see "Selecting a program from the chain play list" on page 10).

<Notes on playing back the chain play list>

When the play mode is set to any option but "Off", the recorder immediately locates to the start point of the program set to step 1 (C01) in the play list, and then stops.

If you move the recorder to a position out of the range between the Auto Return Start and End points (or after the REC END point), "Out of Zone" is shown instead of the step number. In such a condition, the recorder does not correctly execute chain play. The worst case is that you start chain play when the recorder position is after the Auto Return End point (or the REC END point). The recorder never moves to the next program.

To move the recorder to the start point of a program, reselect a program you want to start chain play from by following the procedure described below.

Selecting a program in the chain play list

If the play mode is set to any option but "Off", you can select a program only from those set to the chain play list. By selecting a program, you can start chain play from the desired step in the chain play list.

In the following procedure, it is assumed that the chain play list has been made, the play mode is set to an option but "Off", and the program set to the first step of the chain play list is loaded.

<Note>

If you want to select any program on the disk, as usual, turn off the power and then on, or set the chain play mode to "Off" (see "Setting the chain play mode").

1) While the recorder is stopped, press the [PGM SEL] key.

After showing "Select Change No!" immediately, the display changes to show the screen as below, on which the current program list number and "Sure?" flash.

In this condition, you can select another program set in the list by rotating the [JOG] dial.

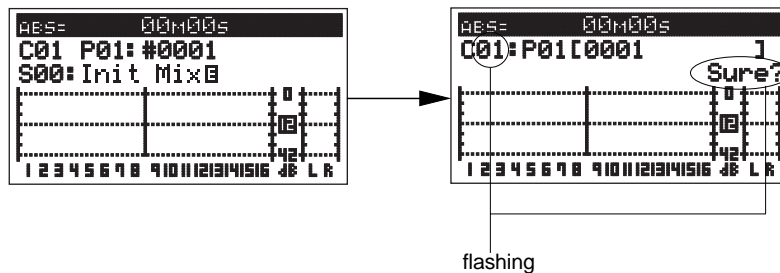

2) Use the [JOG] dial to select the desired step and press the [ENTER/YES] key.

The program set to the selected step is loaded and the recorder is stopped at the beginning of the program (ABS 0), while the display shows the Normal screen.

In the screen examples below, program 4 (P04) set to step 4 (C04) is selected.

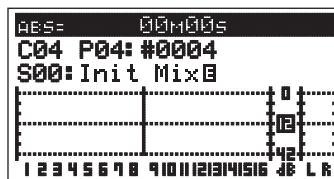

As described above, by selecting a program while the chain play mode is set to any option but "Off", you can start chain play from the desired program.

Editing the chain play list

You can replace a program in the chain play list with another program, delete a program from the list, or add a new program to the list.

• Deleting (or replacing) a program in the chain play list

You can delete a desired program from the chain play list or replace a program in the list with another program by following the procedure below.

- 1) **While the recorder is stopped, press the [SETUP] key to enter the setup mode.**
The screen for selecting a menu item in the setup mode appears.

- 2) **Use the [JOG] dial to select "Chain Play List", and press the [ENTER/YES] key.**
The display changes to show the "Chain Play List" screen as below.

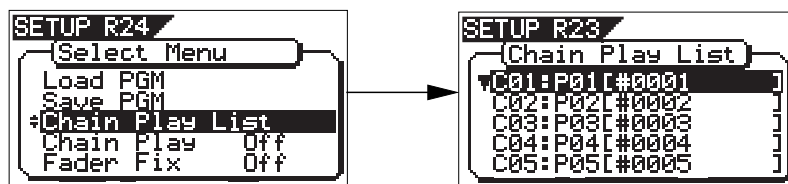

- 3) **Use the [JOG] dial to select the step you want to edit, and press the [ENTER/YES] key.**

The program number set to the selected step starts flashing.
In the example below, "P03" which is set to step 3 (C03) is flashing.

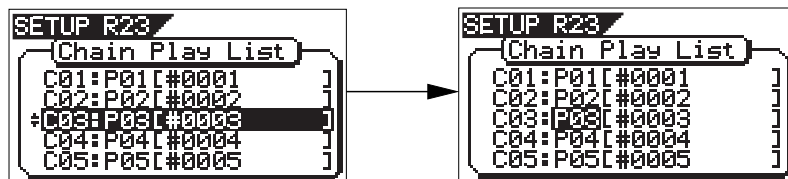

- 4) **Use the [JOG] dial to select "DEL" (or a desired program) and press the [ENTER/YES] key.**

To delete the program from the chain play list, select "DEL". To replace the program with another program, select a desired program.
If you delete the program from the list, all the programs set to the subsequent steps automatically slide up, as shown below.

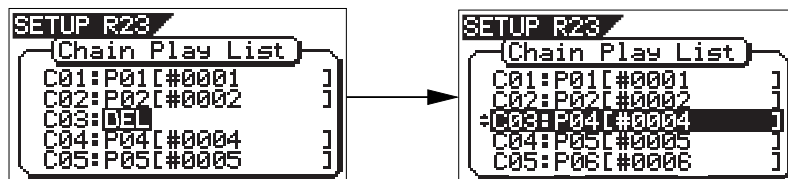

If you select a desired program, the program set to the selected step is replaced and other steps are not affected (in the following example, "P03" set to "C03" is replaced with "P08").

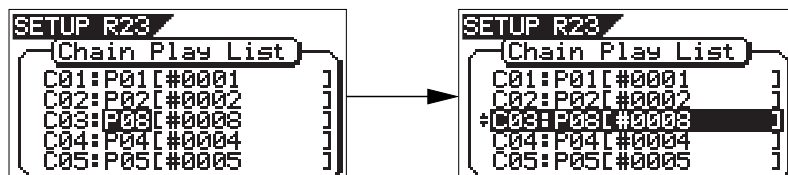

To delete (or replace) another program, repeat the procedure shown above.

- 5) **Press the [EXIT/NO] key to exit the "Chain Play List" screen.**

The display returns to the "Select Menu" screen where the current option of the "Chain Play" mode setting is flashing.

<Note>

If you delete or replace a program in the chain play list when "Chain Play" is set to any option but "Off", the "Chain Play" setting automatically changes to "Off" (which is the default). Therefore, to execute chain play after editing the chain play list, you must make the "Chain Play" mode setting appropriately again.

Deleting all programs from the chain play list

You can delete all the program in the chain play list simultaneously.

- 1) **Follow procedure steps 1) and 2) on page 11 to show the "Chain Play List" screen.**
(i.e. enter the setup mode and select "Chain Play List".)
- 2) **While step 1 (C01) is highlighted (selected), press the [ENTER/YES] key.**
The program number set to step 1 (P01) starts flashing.
If step 1 ("C01") is not highlighted, use the [JOG] dial to select step 1 and press the [ENTER/YES] key.

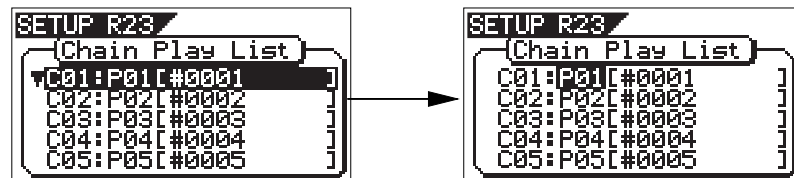

- 3) **Use the [JOG] dial to select "END" and press the [ENTER/YES] key.**
All the programs in the list are deleted at once and the screen shows as below ("C01: END" is shown in the chain play list, which means no program is entered to the list).

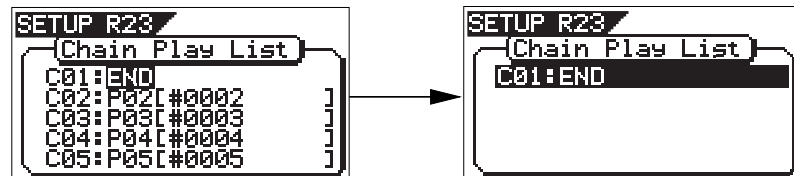
**<Note>**

If you select any step but "C01" in procedure step 2) above and follow procedure step 3), programs set to the selected and subsequent steps are deleted from the list.

For example, if you set "END" to step 3 (C03) in the chain play list where ten steps are currently set, programs set to steps 3 through 10 are all deleted, while programs set to steps 1 and 2 remain.

- 4) **Press the [EXIT/NO] key repeatedly until the setup mode exits.**
The "Chain Play" mode setting is automatically changed to "Off".

Inserting a program to the chain play list

You can insert a program to a desired step in the current chain play list.

- 1) Follow procedure steps 1) and 2) on page 11 to show the "Chain Play List" screen. (i.e. enter the setup mode and select "Chain Play List".)

- 2) Use the [JOG] dial to select a step where you want to add a program and press the [ENTER/YES] key.

The program number set to the selected step starts flashing. If you select "C02" on the left screen example below, "P02" starts flashing.

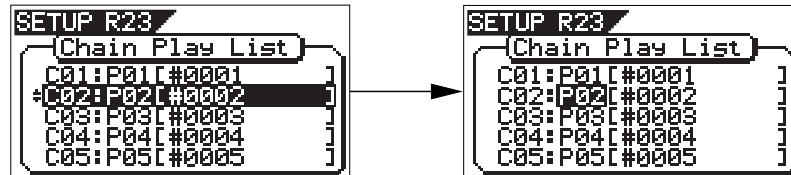

- 3) Use the [JOG] dial to select "INS" and press the [ENTER/YES] key.

You can now select a program to be inserted. Initially, "P01" flashes.

As you can see by comparing the two screen examples above, the programs set to the second and subsequent steps slide down automatically.

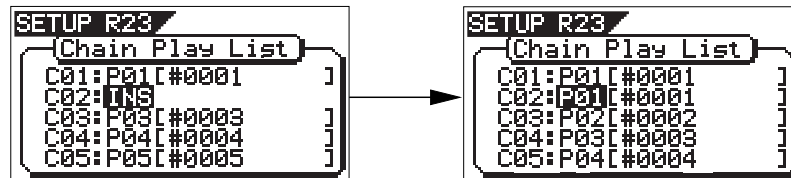

- 4) Use the [JOG] dial to select a program to be inserted, and press the [ENTER/YES] key.

In the example shown below, program 6 (P06) is inserted to step 2.

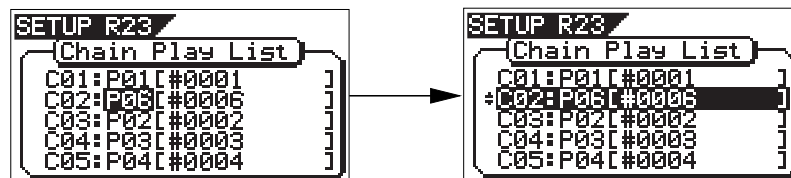

If you want to insert a program to another step, repeat the same procedure above.

<Note>

You can enter up to 99 programs to the play list. If you are trying to enter a program to the play list where 99 programs are already registered, "Void! Play List is Full" is shown and the operation is canceled.

- 5) After inserting all desired programs, press the [EXIT/NO] key.

The "Chain Play List" screen is dismissed and the display returns to the "Select Menu" screen where the current option of the "Chain Play" mode setting is flashing.

<Note>

If you insert the desired program(s) to the chain play list when the "Chain Play" mode is set to any option but "Off", the "Chain Play" setting automatically changes to "Off" (the default).

Therefore, to execute chain play after editing the chain play list, you must set the "Chain Play" mode appropriately again.

- 6) After setting the "Chain Play" mode appropriately, press the [EXIT/NO] key repeatedly until exiting the setup mode.

Changes in audio CD recording functionality

With the version 2.0 software, the following two changes in audio CD (CD-DA) recording functionality as described below, are made. See also "Making an audio CD" on page 120 of the original owner's manual.

Change in the automatic silence recording function between songs

When burning an audio CD using the VF160 of the previous version with the optional CD-R/RW drive (Model CD-1A) installed, an approximately two second silent space was automatically recorded between songs when recording more than one song continuously (see Figure 4 below).

With the new version, no silent space is automatically recorded, which means songs are recorded with no space between them, as shown in Figure 5 below. Therefore, when playing back the audio CD made with the new version, song 2 starts immediately after finishing song 1.

With the previous version

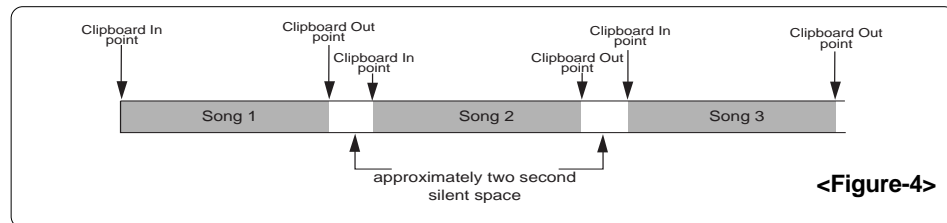

With the new version

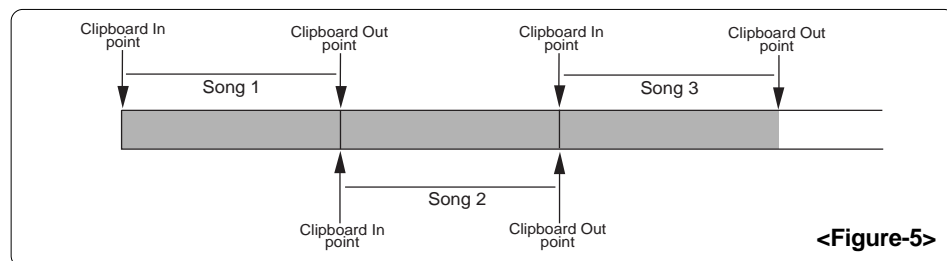

If you want to have a silent space between songs when burning an audio CD, you can create a desired silent space in the mastering process using the internal mixdown function or after finishing mastering. Use either of the methods described later. For details about the internal mixdown function, see page 79 of the original owner's manual.

Change in the CD-R/RW setup menu

The new "EventEnable" setting is added to the "CD-R/RW setup" screen, which can be brought up from the "Save PGM" menu item in the setup mode and is used to set the writing condition when burning an audio CD. This "EventEnable" setting selects whether enabling or disabling the events stored in the tracks.

See page 17 for details about how to make the "EventEnable" setting.

Previous version

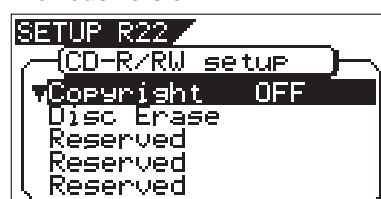

New version

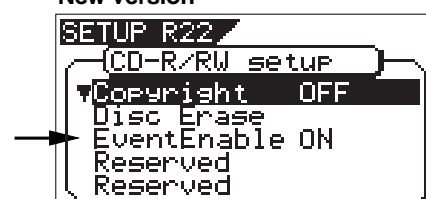

<How to make a silent space between songs in the mastering process>

When mastering a song in the internal mixdown mode, do not stop recording at the song end point. Instead, continue recording with the fader down for a few seconds from the song end point and then stop recording.

See Figure 6 below. At the end point of the song to be mastered, put the [MASTER] fader down completely, and continue recording for a few more seconds then stop.

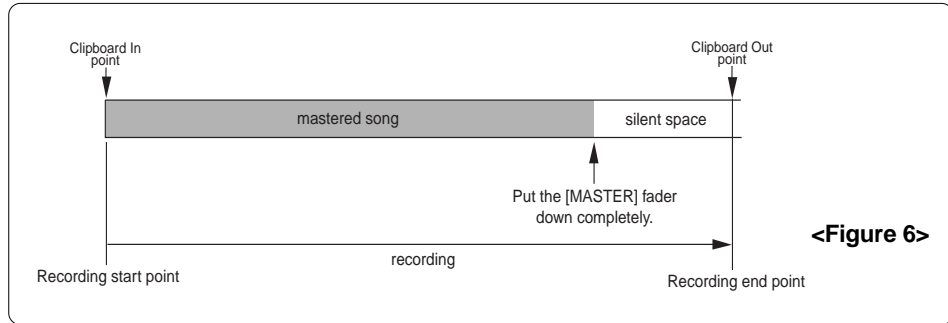

The recording start and end points are automatically registered as the clipboard in and clipboard out points, respectively. Therefore, the recording end position shown above (which is after the silent space) is registered as the clipboard out point of the mastered material.

By mastering each material with a silent space as described above, you can burn an audio CD with silent spaces between songs, as shown in Figure 7 below.

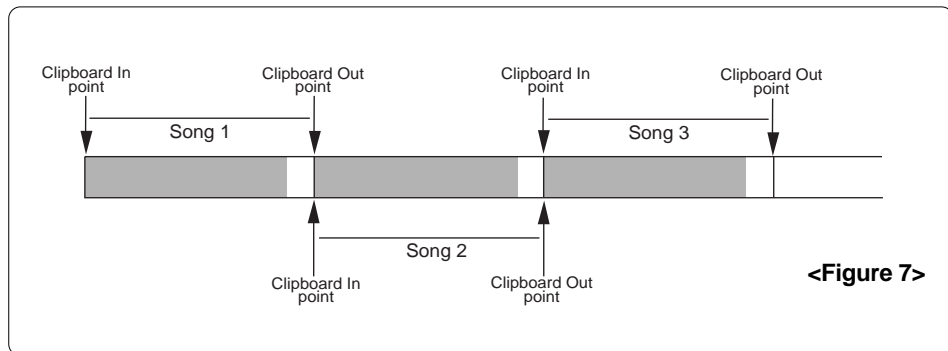

<How to insert a silent space after completing mastering>

If a mastered song does not have a silent space, you can add a silent space later by shifting the clipboard out point backwards, as shown in Figure 8 below.

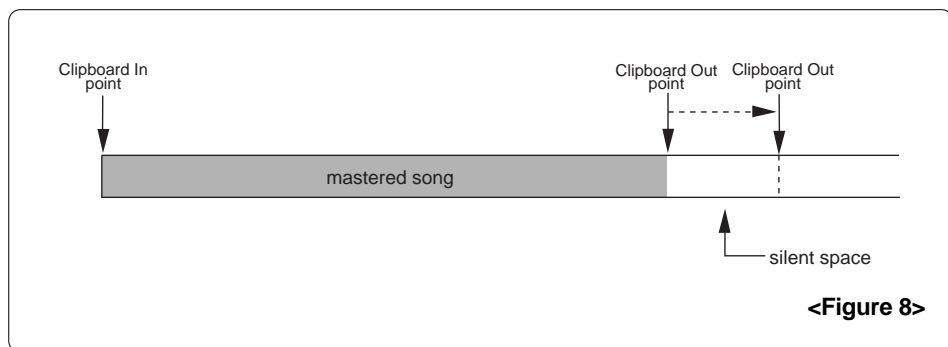

See the next page for details about how to edit the clipboard out point.

How to edit the clipboard out point

The following procedure describes how to edit the clipboard out point, assuming that a program mastered by the internal mixdown mode is currently loaded.

- 1) **While the VF160 is stopped, press the [CLIPBOARD OUT] key.**

The display shows the current Clipboard Out point data in which "s" (second) flashes.

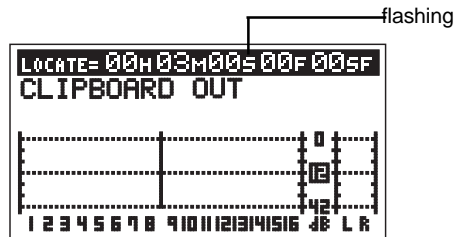

- 2) **You can move the flashing point (edit point) using the [REWIND] or [F FWD] key, while you can edit the value using the [JOG] dial.**

For example, to edit the current value ("00H 03M 00S 00F 00SF") to "00H 03M 05S 00F 00SF", while "s" flashes, use the [JOG] dial to enter "05".

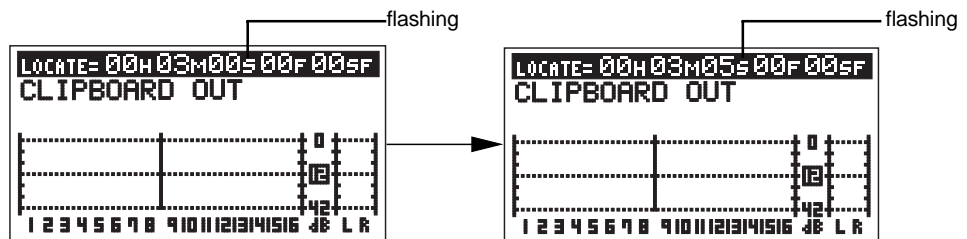

- 3) **After making editing, press the [STORE] key.**

The display shows "Hit Any Memory Keys!".

Now, hitting any desired memory key will store the data to the associated memory.



- 4) **Press the [CLIPBOARD OUT] key.**

The edited time data is stored to the Clipboard Out point, while the edit mode exits and the display returns to show the Normal screen.

Event enable/disable setting

The event enable/disable setting is added to the "CD-R/RW setup" screen which can be brought up by selecting "Setup" from "Mode Select" options in the "Save PGM" menu item of the setup mode. This setting allows you to select whether enabling (ON) or disabling (OFF) the events stored between the clipboard in and clipboard out points when burning a material to an audio CD. The default is "ON", as shown in the screen example below. In some cases, "EventEnable" should be set to "OFF" (the setting remains when turning the power off and then on).

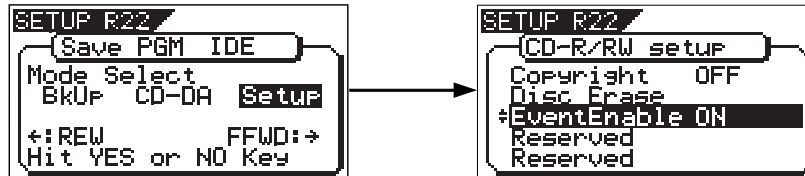

Setting	Function
ON (default)	Enables events between the clipboard in and out points. When making an audio CD, a mastered material is divided into tracks separated by the events.
OFF	Disables events between the clipboard in and out points. When making an audio CD, a mastered material is not divided into tracks (i.e. a material is burned as a single track).

On a material which is mastered by the internal mixdown mode, the clipboard in and clipboard out points are automatically registered. The clipboard in point is also regarded as the beginning of a CD track. The VF160 recognizes the area between the clipboard in and clipboard out points as a single CD track when burning it to a CD-R/RW disc.



During mastering, events (EVT 01, EVT 02, EVT 03, etc.) may be used for locate etc. If you make an audio CD by burning a mastered material which has such events between the clipboard in and clipboard out points, you should set "EventEnable" to "OFF". (At the start point, "EVT 00" is automatically marked.)

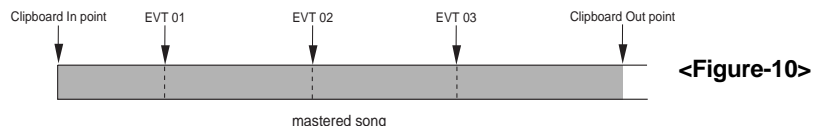

If you set "EventEnable" to "ON" and make an audio CD with a material which has such events between the clipboard in and clipboard out points, each event divides the material into separate tracks. In result, more than one track is created, instead of a single track. Therefore, when you make an audio CD by burning a mastered material which has such events, you must set "EventEnable" to "OFF" in order not to divide the single material into more than one track.

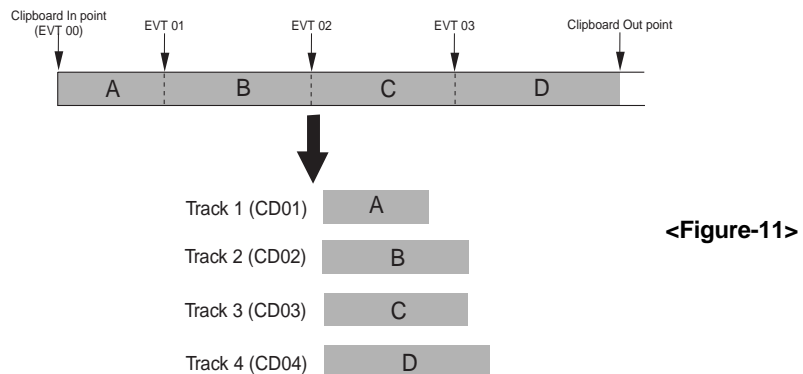

<"EventEnable" should also be set to "OFF" in such a case!>

Let's assume that there are two programs; program 1 and program 2. The material in program 1 has events, while the material in program 2 does not (as shown in figure below).

If you make an audio CD from these two materials, burn a disc with "EventEnable" set to "OFF". In result, you can make a CD containing two tracks (ignoring events on program 1).

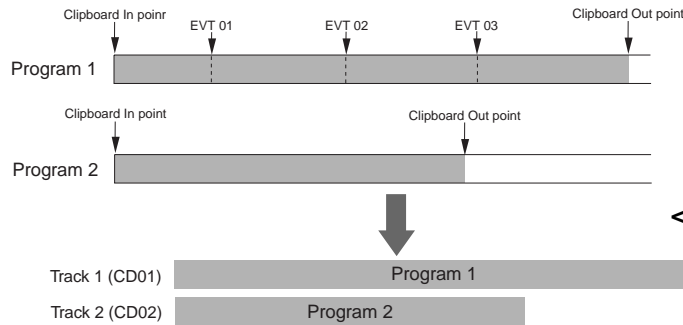

<Figure-12>

If you burn a disc with "EventEnable" set to "ON", program 1 is divided into four tracks. In result, a CD containing five tracks (four from program 1 and one from program 2) is made.

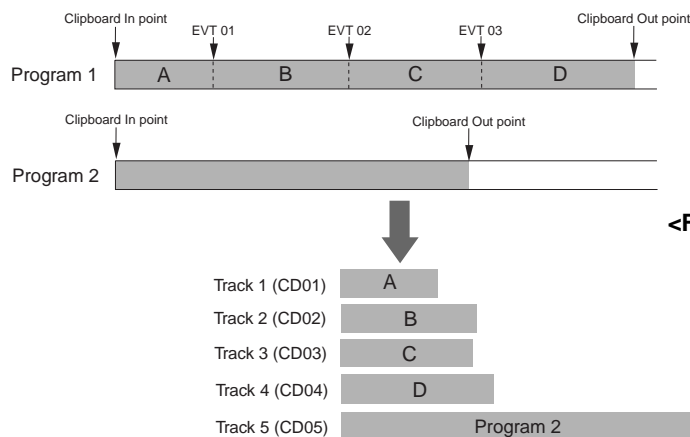

<Figure-13>

<"EventEnable" should be set to "ON" in such a case!>

When loading more than one track from an audio CD you made to the VF160 hard disk, all the tracks are loaded onto a single program (see page 22), in which an event is automatically registered to the beginning of each track.

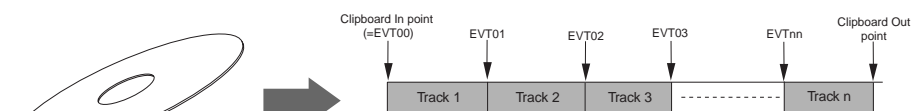

<Figure-14>

When making an audio CD from a program which contains more than one track originally loaded from an audio CD, set "EventEnable" to "ON".

This allows making a CD which contains the same number of tracks as the number of tracks originally loaded from an audio CD.

Newly added audio CD playback mode

In version 2.0, the audio CD playback mode is newly added. This mode allows playing back an audio CD (regardless of whether it is made using the VF160 or on the market) using the CD-R/RW drive (model CD-1A) which is optionally installed.

By switching the HDD playback mode to the audio CD playback mode, you can operate the CD-R/RW drive from the transport keys ([PLAY], etc) on the VF160 panel for monitoring an audio CD.

<Notes>

- You can play back an audio CD only when the optional CD-1A is installed. You cannot play back an audio CD by a SCSI CD-R/RW drive.
- You cannot play back an audio CD which is copy-protected.
- Never try to play back a disc which is not an audio CD (CD-DA). This may damage the VF160.
- In the audio CD playback mode, you can use functions such as locate, scrub, auto function and effect editing, as with internal HDD playback. However, note that the access speed is not guaranteed.

Switching the playback mode

When turning the power on, the VF160 always starts up in the internal HDD playback mode. In the following description, it is assumed that the optional CD-R/RW drive is installed to the VF160 and an audio CD (burned using the VF160 or on the market) is inserted to the drive.

•When the HDD is stopped, press the [SCRUB] key while holding down the [SHIFT] key.

After the associated warning message as shown below appears, the playback mode changes. Executing the above operation alternatively switches the playback mode. In the audio CD playback mode, only the [CH STATUS/CH SEL] keys for tracks 1, 2 and [MASTER] are lit, while the other [CH STATUS/CH SEL] keys are unlit, showing that only the faders for track 1, 2 and [MASTER] are effective. (This means that the playback level of the audio CD is adjusted using the faders for tracks 1, 2 and [MASTER].)

<Caution>

When switching the playback mode, make sure that the VF160 is not accessing the CD-R/RW disc.

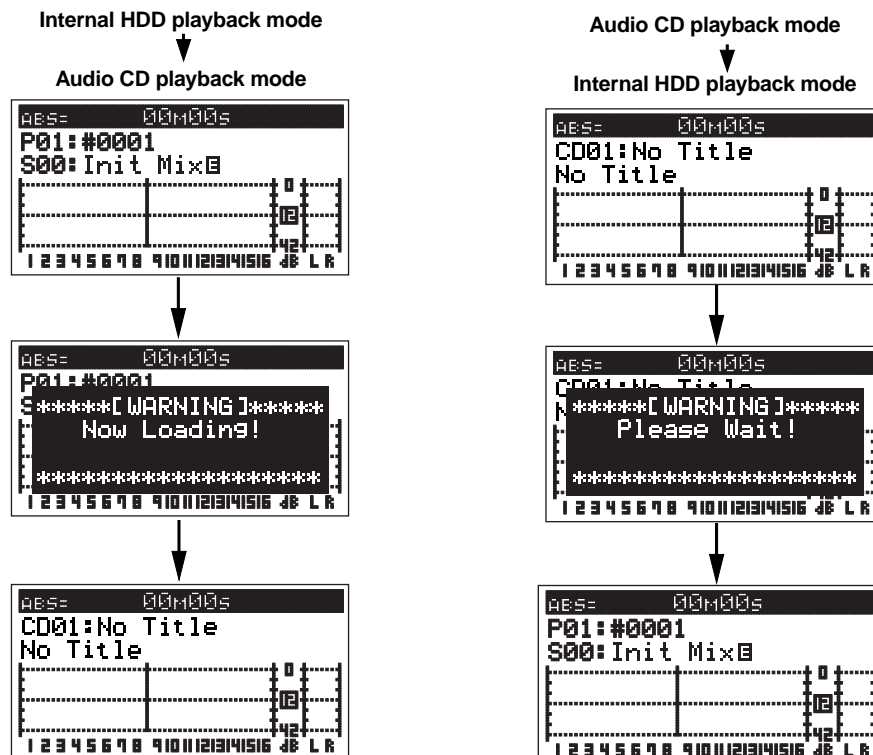

Available functions in the audio CD playback mode

In the audio CD playback mode, the following functions are available.

If you are going to carry out any function other than the following, a warning message is shown and the operation is ignored (for example, if you press the [RECORD] key while holding down the [SHIFT] key, "[WARNING!] Void Key CD PLAYER" is shown.

• Normal playback

You can play back an audio CD with the same manner as with a program in the internal HDD. You can control the playback level using the faders for tracks 1, 2 and [MASTER].

<Note>

If you press the [PLAY] key, the key indicator flashes for a while. This shows that the system is in preparation for audio CD playback. When it is ready, playback starts.

• Track skip

If an audio CD contains more than one track, pressing [REWIND/PREV] or [F FWD/NEXT] key while holding down the [SHIFT] key skips a track. By pressing the key, "Locate: EVT ***" (** shows the event number) is shown on the display, and the playback position skips (locates) to the beginning of the appropriate track.

• Auto functions

When the Start and End points are correctly set, the auto functions (Auto play, Auto return, Auto repeat, etc.) are available.

* See page 69 of the owner's manual for details about the auto functions.

• Varipitch playback

You can use the varipitch playback function which allows to alter the playback speed within +/- 6.0 % range in 0.1 % increments/decrements.

* For details about the varipitch function, see page 68 in the owner's manual.

• Effect, EQ and pan controls

You can use the effect, EQ and pan controls for tailoring the playback sound.

* For details about the effect function, see pages 41 and 52 in the owner's manual.

* For details about the EQ function, see pages 40 and 51 in the owner's manual.

* For details about the pan control, see pages 40 and 50 in the owner's manual.

• Ejecting an audio CD

In the audio CD playback mode and when the VF160 is not accessing the disc, you can eject a disc in the CD-R/RW drive by pressing the [EXIT/NO] key while holding down the [SHIFT] key, or pressing the eject key on the CD-RW drive.

• Display time mode selection

By pressing the [DISP SEL] key, you can select the time mode on the display from among "ABS", "Offset" and "MTC". For details about the time mode selection In the internal HDD playback mode, see page 30 of the owner's manual.

* See the next page for details about the time display.

Display in the audio CD playback mode

When switching to the audio CD playback mode, the display looks like the example below.

By pressing the [DISP SEL] key while holding down the [SHIFT] key, you can switch the time base.
By pressing only the [DISP SEL] key, you can switch the display mode in the current time base. See the table below for details.

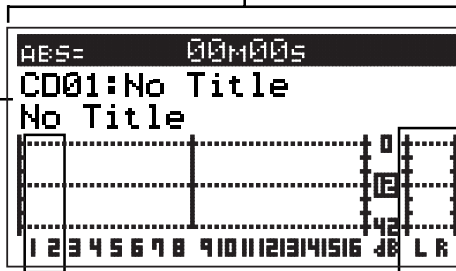

This section shows the current track number and name. In this example, "CD01" shows the current track number is "01". On the right of the track number, the track name is shown when playing back a CD TEXT disc (an audio CD containing text information) which has track title information. If the name is long and exceeds the display area, it is scrolled in the next row. When playing back a normal audio CD (which does not contain text information) available on the market or burned using the VF160, "No Title" is shown, as this example.

When an audio CD which has more than one track is set, pressing the [REWIND/PREV] or [F FWD/NEXT] key while holding down the [SHIFT] key locates to the beginning of an appropriate track while the display shows "Locate: EVT**".

In the audio CD playback mode, only the level meters for tracks 1, 2 and L/R master are effective. The playback level can be controlled using the faders for tracks 1, 2 and [MASTER].

• Time base selection by "[SHIFT] + [DISP SEL]"

ABS	Disc elapsed time is shown. The time starts from the beginning of a disc. The loop start and end points refers to disc elapsed time.
OFFSET	Track elapsed time is shown. Track time starts from the beginning of each track. Naturally, at the point each track starts playback, the display shows "00m00s".
MTC	MTC (MIDI Time Code) is shown. It has an offset of 59 minutes 57 seconds to "ABS 0" (the same offset as the internal HDD playback mode).

• Display mode selection in the current time base by the [DISP SEL] key

When the current time base is ABS:	You can switch between "ABS", "OFFSET" and "MTC IN".
When the current time base is OFFSET:	You can switch between "OFFSET" and "MTC IN".
When the current time base is MTC:	You can switch between "MTC", "OFFSET" and "MTC IN".

MTC IN: Show the MTC time input in the [MIDI IN] jack.

Function enhancement on audio CD track loading

The audio track loading function which is available by installing the optional CD-1A (CD-R/RW drive) has been enhanced. With the previous version, you can load the specified track(s) from an audio CD. With version 2.0, you can also load all tracks from an audio CD at once.

With this function enhancement, the procedure for loading data from an audio CD described on page 123 in the VF160 manual has been changed.

Please follow the procedure below not only when loading all track at once but also when loading a single track.

How to load tracks from an audio CD

In the following operation, we assume that the optional CD-1A (CD-R/RW drive) is installed to the VF160 and an audio CD created by the VF160 (or on the market) is prepared.

<Important notice on copyright>

Never use a material loaded from an audio CD on the market for a commercial purpose unless you own the copyright, or have obtained the appropriate permission from the copyright owner or the rightful licensor. Your unauthorized use for a commercial purpose thereof, may result in severe civil and criminal penalties under copyright laws and international copyright treaties.

- 1) Turn on the VF160 and set an audio CD to the CD-R/RW drive.
- 2) Press the [SETUP] key to enter the setup mode.
- 3) Rotate the [JOG] dial to select "Load PGM" and press the [ENTER/YES] key.
The display changes to show the screen for selecting the source device of loading, on which "IDE" flashes.

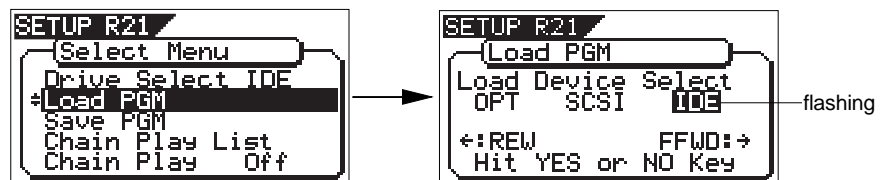

- 4) While "IDE" is flashing, press the [ENTER/YES] key.
The display changes to show the screen for selecting the load mode, on which "CD-DA" flashes.

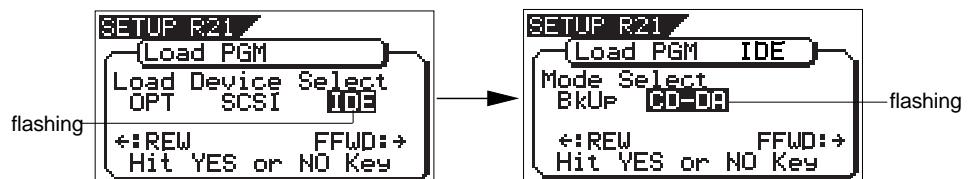

- 5) While "CD-DA" is flashing, press the [ENTER/YES] key.
The display now shows the warning message for the copyright. By rotating the [JOG] dial, you can scroll the message.

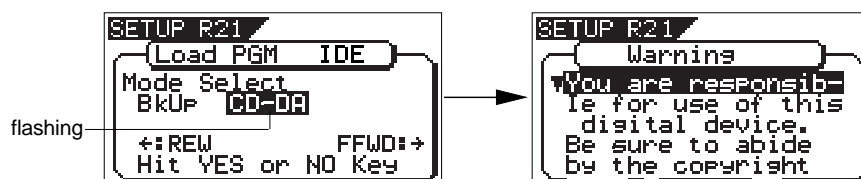

- 6) **If you agree to the message contents, press the [ENTER/YES] key.**
 The display changes to show the screen for selecting the load type, on which “One” flashes. This screen has been newly added with version 2.0. You can select a desired load type from among the following.

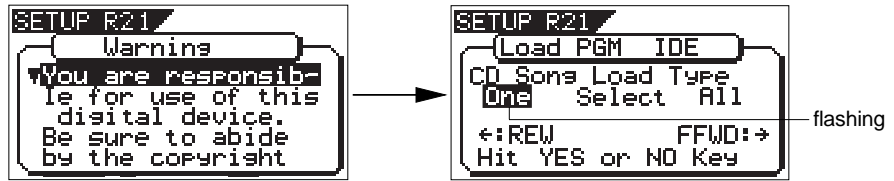

One	You can select one or more tracks to be loaded. Each selected track is individually loaded to a new program automatically created on the current drive.
Select	You can select one or more tracks to be loaded. All the selected tracks are individually loaded to a new program automatically created on the current drive.
All	All the tracks on an audio CD are loaded to a new program automatically created on the current drive.
* “A new program automatically created on the current drive” has the program number one higher than the current highest program number.	

- 7) **Select the desired load type and press the [ENTER/YES] key.**

Depending on the selected load type, the display shows as below.

• **When selecting “One” or “Select”:**

The screen as shown below appears.

The left column shows the track numbers (01, 02...) of the audio CD, while “NON” in the second column shows no program is selected.

“▼” is shown when more than one track is recorded on the audio CD. It is not shown when only one track is recorded on the audio CD. If only one track is recorded on the audio CD, “▼” is not shown. To select desired tracks to be loaded, go to step 8.

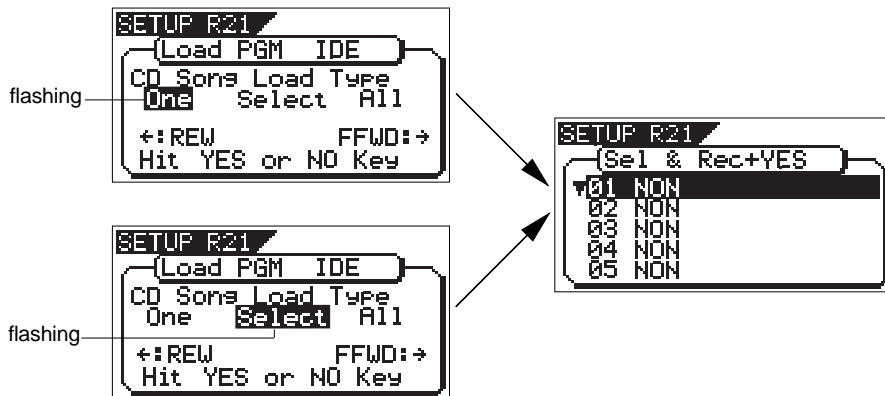

• **When selecting “All”:**

All tracks on the audio CD are selected to be loaded, and the screen as shown below appears. In this screen example, the destination program newly created on the current drive is “P05”. Each track time is also shown.

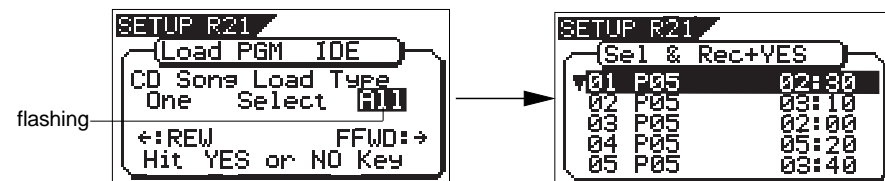

When selecting “All”, you can start loading tracks to the current drive by pressing the [ENTER/YES] key while holding down the [RECORD] key. You can delete an unnecessary track if you want. See <Hint> below about how to do it.

<Hint>

Before executing "All" track loading, you can delete an unnecessary track by the following procedure.

- 1) While the display shows the screen as above, use the [JOG] dial to highlight the desired track and press the [ENTER/YES] key.
The destination program number of the selected track starts flashing.
- 2) Use the [JOG] dial to select "NON" and press the [ENTER/YES] key.
A track whose destination program number is set to "NON" is not loaded.

8) Use the [JOG] dial to select (highlight) a desired track to be loaded and press the [ENTER/YES] key.

The load destination program number of the selected track is shown as a flashing display, as well as the track time. In the screen example below, track 1 (01) is selected. The total time is also shown above the track list. (The total time is summed up each time you select another track.)

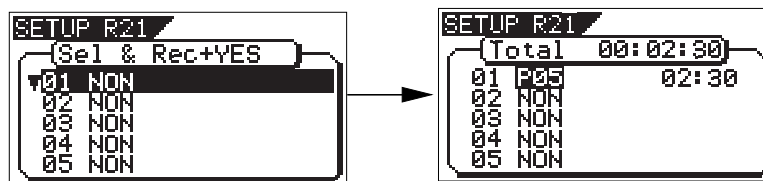

In this condition, you can choose the option between "Pxx" (program number) and "NON" using the [JOG] dial. To cancel the track selection, choose "NON" and press the [ENTER/YES] key. To set the track to be loaded, go to the next step.

9) Press the [ENTER/YES] key.

The selected track ("01", in this example) is set, while the screen changes as below.

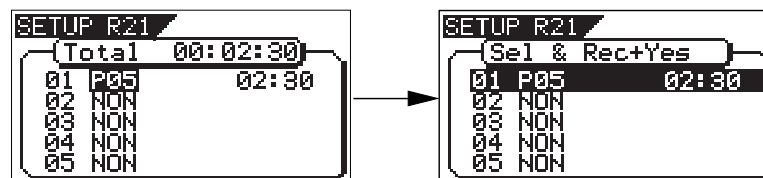

10) Use the [JOG] dial to select (highlight) another desired track to be loaded and press the [ENTER/YES] key.

In the example below, track 2 (02) is selected (of course, you can select whichever track you want). Depending on the load type ("One" or "Select") selected in step 7) above, the screen shown is slightly different.

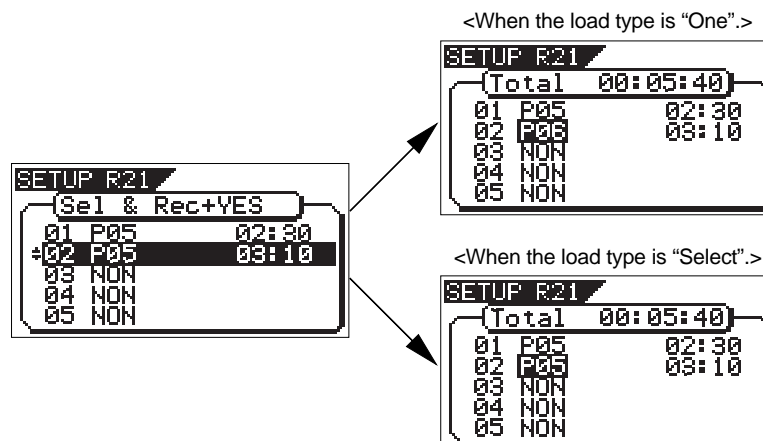

When you set the load type to "One", the load destination program number for the secondly selected track is one higher than that for the firstly selected track. That is, the load destination program number is counted up each time you select a track.

On the contrary, when you set the load type to "Select", the load destination program number for the secondly selected track is same as the firstly selected track. That is, all selected tracks are loaded to the same program.

11) Press the [ENTER/YES] key.

As with the firstly selected track, the secondly selected track ("02", in this example) is set.

12) Operate the same procedure as above for selecting other tracks.

13) When completing selecting all desired tracks, press the [ENTER/YES] key while holding down the [RECORD] key.

The display shows "Data Loading!" while the remaining data amount (in MB) is counted down. You cannot cancel loading once it starts. Wait for a while until loading is completed. Loading more amount takes more time.

When completing loading, "Completed!" is shown, while the audio CD is automatically ejected from the CD-R/RW drive.

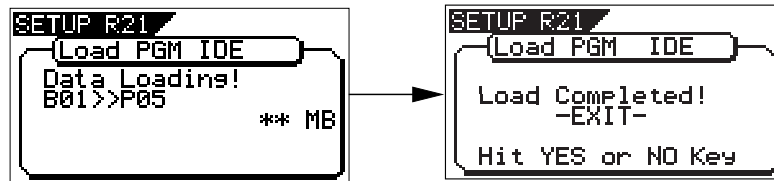

14) Press the [EXIT/NO] key to exit the setup mode.

<Hint>

To play back a desired loaded track on the current drive, carry out the following operation depending on the load type.

• **To play back a track loaded with the type set to “One”:**

1. **Select the appropriate program to which the track to be played back is loaded by following the procedure below.**
See “Selecting a program” on page 70 of the owner’s manual for details about how to select a program.
 - 1-1. **Press the [PGM SEL] key.**
 - 1-2. **Use the [JOG] dial to highlight the appropriate program.**
 - 1-3. **Press the [ENTER/YES] key.**
2. **Press the [PLAY] key to start playback of the track.**

• **To play back tracks loaded with the type set to “Select” or “All”:**

1. **Select the destination program by following the same procedure as step 1 above.**
2. **Select a desired track in the program by pressing the [REWIND/PREV] or [F FWD/NEXT] keys while holding down the [SHIFT] key when the recorder is stopped or during playback.**
Because all the tracks loaded take part in the same program, you have to select a track within the program.

The VF160 automatically set an event at the beginning of each track loaded with the type set to “Select” or “All”, so pressing [REWIND/PREV] or [F FWD/NEXT] key while holding down the [SHIFT] key locates to the beginning of the previous or next track, as with a typical CD player on the market (see “Event function” on page 36 of the owner’s manual).

3. **Press the [PLAY] key to start playback of the track.**

To check events, press the [SCENE STORE/MAP] key while holding down the [SHIFT] key while the recorder is stopped. The display shows the event map, allowing you to check the event positions (in the screen example below, the time base is set to “Bar/Beat/Clk”).

EVENT MAP		Bar	
Event No.	Select		
00	-2BAR	1	00 S00
01	126BAR	3	14 Non
02	267BAR	2	10 Non
03	331BAR	3	15 Non
04	528BAR	5	09 Non

Memo

Fostex

FOSTEX CO.

3-2-35 Musashino, Akishima-shi, Tokyo, Japan 196-0021

FOSTEX AMERICA

15431, Blackburn Avenue, Norwalk, CA 90650, U. S. A.