



Owner's Manual

Digital Multitracker

VFO8



	CAUTION RISK OF ELECTRIC SHOCK DO NOT OPEN	
<p>CAUTION: TO REDUCE THE RISK OF ELECTRIC SHOCK, DO NOT REMOVE COVER (OR BACK). NO USER - SERVICEABLE PARTS INSIDE. REFER SERVICING TO QUALIFIED SERVICE PERSONNEL.</p>		

<p>CAUTION: TO PREVENT ELECTRIC SHOCK, MATCH WIDE BLADE OF PLUG TO WIDE SLOT, FULLY INSERT.</p> <p>ATTENTION: POUR ÉVITER LES CHOCS ÉLECTRIQUES, INTRODUIRE LA LAME LA PLUS LARGE DE LA FICHE DANS LA BORNE CORRESPONDANTE DE LA PRISE ET POUSSER JUSQU' AU FOND.</p>



The lightning flash with arrowhead symbol, within an equilateral triangle, is intended to alert the user to the presence of uninsulated "dangerous voltage" within the product's enclosure that may be of sufficient magnitude to constitute a risk of electric shock to persons.



The exclamation point within an equilateral triangle is intended to alert the user to the presence of important operating and maintenance (servicing) instructions in the literature accompanying the appliance.

"WARNING"

"TO REDUCE THE RISK OF FIRE OR ELECTRIC SHOCK, DO NOT EXPOSE THIS APPLIANCE TO RAIN OR MOISTURE."

SAFETY INSTRUCTIONS

1. Read Instructions - All the safety and operating instructions should be read before the appliance is operated.
2. Retain Instructions - The safety and operating instructions should be retained for future reference.
3. Heed Warnings - All warnings on the appliance and in the operating instructions should be adhered to.
4. Follow Instructions - All operating and use instructions should be followed.
5. Water and Moisture - The appliance should not be used near water - for example, near a bathtub, washbowl, kitchen sink, laundry tub, in a wet basement, or near a swimming pool, and the like.
6. Carts and Stands - The appliance should be used only with a cart or stand that is recommended by the manufacturer.



An appliance and cart combination should be moved with care. Quick stops, excessive force, and uneven surfaces may cause the appliance and cart combination to overturn.

7. Wall or Ceiling Mounting - The appliance should be mounted to a wall or ceiling only as recommended by the manufacturer.
8. Ventilation - The appliance should be situated so that its location or position does not interfere with its proper ventilation. For example, the appliance should not be situated on a bed, sofa, rug, or similar surface that may block the ventilation openings; or, placed in a built-in installation, such as a bookcase or cabinet that may impede the flow of air through the ventilation openings.

9. Heat - The appliance should be situated away from heat sources such as radiators, heat registers, stoves, or other appliances (including amplifiers) that produce heat.
10. Power Sources - The appliance should be connected to a power supply only of the type described in the operating instructions or as marked on the appliance.
11. Grounding or Polarization - The precautions that should be taken so that the grounding or polarization means of an appliance is not defeated.
12. Power Cord Protection - Power supply cords should be routed so that they are not likely to be walked on or pinched by items placed upon or against them, paying particular attention to cords at plugs, convenience receptacles, and the point where they exit from the appliance.
13. Cleaning - The appliance should be cleaned only as recommended by the manufacturer.
14. Nonuse Periods - The power cord of the appliance should be unplugged from the outlet when left unused for a long period of time.
15. Object and Liquid Entry - Care should be taken so that objects do not fall and liquids are not spilled into the enclosure through openings.
16. Damage Requiring Service - The appliance should be serviced by qualified service personnel when:
 - A. The power supply cord or the plug has been damaged; or
 - B. Objects have fallen, or liquid has been spilled into the appliance; or
 - C. The appliance has been exposed to rain; or
 - D. The appliance does not appear to operate normally or exhibits a marked change in performance; or
 - E. The appliance has been dropped, or the enclosure damaged.
17. Servicing - The user should not attempt to service the appliance beyond that described in the operating instructions. All other servicing should be referred to qualified service personnel.

Contents

- Safety Instructions 2

Basic Features of VF08

- Product Features 6
- Precautions 7
 - About power supply 7
 - Precautions upon handling the hard disk 7
 - Note on repair 7
 - About copyright 7
 - About damage 7
- Before Operating 8
 - RECORDING method 8
 - Program 8
 - Remain Indicator 8
 - Additional track 9
 - INPUT monitor and REPRO monitor 9
 - Event 9
 - Trim 10
 - Time Base 10

Names and Functions

- Top panel (Analog input/output section) 12
- Top panel (Mixer section) 13
- Top panel (Recorder/display section) 14
- Rear panel 17
- Side Panel 17

About the hard disk storage device

- Reformatting the Hard Disk 18
- Replacing a Hard Disk 19
- Formatting the New Hard Disk 21

Basic Recording and Playback

- Connections of external equipment 22
- LCD 23
 - Display when turning on the power 23
 - Switching the time base 23
 - “Disk remain” indication 23
- Preliminary knowledge 24
 - Inputs and tracks 24
 - How to use condenser microphones 24
- Basic recording (recording onto a single track) .. 25
 - Preparation for recording 25
 - Recording 26
 - Playback 26

- Basic recording (recording onto two track) 27
 - Preparation for recording 27
 - Recording 28
 - Playback 28
- Mark function 29
 - Setting a mark on the fly 29
 - Locating a mark 29
 - Deleting a mark 29
- ABS Locate 30
- Punch In/Out 30
 - Manual punch in/out using the keys on the unit ... 30
 - Punch in/out using the Foot Switch 30
 - Auto punch in/out function 31
- Mixing 33
 - Adjusting levels 33
 - Setting PAN position 33
 - Adjusting EQ 33
 - Setting effects 34
- Mix Down 35
 - Analog Mix Down 35
 - Digital Mix Down 35

Mixer Functions

- Initial condition when turning the power 36
- Operations while the Normal display is shown 36
 - Fader 36
 - Track mute 36
 - Master fader mute 36
- Mix Parameter Edit 37
 - Adjusting PAN position 37
 - Editing EQ 38
 - Preset entries in the EQ library 39
 - Editing effects 41
 - Setting effects send level 42
 - Selecting an effect type 42
 - Selecting pre/post of the effect send 43
 - Turning the effect processor on or off 43
 - About the effect types 44
 - Scene memory 47
 - Storing the current scene 47
 - Recalling a scene 47
 - Deleting a scene 48
 - Fader adjust 48
 - Scene sequence 49
 - Assigning scene memories to the mark map 49
 - Deleting a mark from the mark map 50
 - Scene sequence on/off selection 50

Recorder Functions

- Cueing 51
 - Cueing with the [F FWD]/[REWIND] keys 51
 - Shuttle cueing 51
 - Digital scrubbing 52
 - Performing digital scrubbing 52
 - Storing the digital scrub point 52
- Variable Pitch 53
 - Turning on or off the vari pitch function 53
 - Setting the Speed 53
- Loop Function 54
 - Setting the start and end points 54
 - Capturing the current position on the fly 54
 - Editing the position via the screen 54
 - Setting the start and end points by marks 55
 - Carrying out the loop playback 55
- Program 56
 - Creating a new program 56
 - Selecting a program 57
 - Deleting a program 57
 - Editing a program title 57
- Track editing 58
 - Copy & Paste and Move & Paste 58
 - Performing Copy (or Move) Paste 59
 - Undo/redo of Copy (or Move) Paste 60
 - Erasing track data 61
 - Erasing 61
 - Undo/redo of Erase 62
 - Track Exchange 63
 - Performing the track exchange 63
- Editing marks 64
 - Viewing the mark list 64
 - Editing a mark position 64
 - Enter a mark title 65
 - Adding a mark 65
 - Deleting a mark 66
 - Locating a mark 66

Advanced Operation

- Metronome function 67
 - Setting the tempo map 67
 - Setting the metronome output 67
 - Setting the time base to bar/beat 67
 - Monitoring the metronome sound 67
- Track bounce (Ping-pong recording) 68
 - On/Off of bounce mode 68
 - Setting pan position 68
 - Setting level of each track 68
 - Performing the track bounce 68

- Training mode 69
 - Connecting the instrument and headphones 69
 - On/Off of training mode 69
 - Slowing down the playback speed 70
 - Changing the pitch 70
 - Canceling the center-positioned sound 70
 - Setting the cancel position 70
 - Boosting the bass sound 70
 - Playing along with the playback sound 70
- Mastering mode 71
 - Selecting a program to be played back 71
 - On/Off of mastering mode 71
 - Setting the mastering effects 72
 - On/Off the mastering effects 72
 - Recording onto the master recorder 72
 - Effect library details 72
- Digital Recording 74
 - Recording an external source onto the VF08 digitally 74
 - Selecting a program to be recorded 74
 - Selecting the digital input 74
 - Selecting a track to record 74
 - Starting to record 74
- MIDI Clock Sync System 75
 - Connecting to external equipment 75
 - Setup of the VF08 76
 - Executing of recording 76
 - Confirming the MIDI clock sync 76
- MIDI Sync/MIDI Machine Control System 76
 - Connecting to external equipment 77
 - Setup of external equipment 77
 - Setup of the VF08 77
 - Confirming MTC sync/MMC 77
 - Executing of recording 77
- External MIDI equipment Sync System by the Slave Mode..78
 - Connecting to external equipment 78
 - Setup of external equipment 78
 - Setup of the VF08 78
 - Confirming chase lock 78
 - Executing of recording 79

Save/Load of Song Data

- About Song Data 80
 - Items that can be saved or loaded as song data 81
 - Notes for digital audio recorder to be used 81
 - Notes for saving data using the S/P DIF digital signal 81
- Saving data using the S/PDIF digital signal 82
 - Connecting to an external digital recorder 82
 - Setting the external recorder 82
 - Saving data 82
- Loading data using the S/PDIF digital signal .. 84
 - Connecting to an external digital recorder 84

Setting the external recorder 84
 Loading data 84

- Saving /Loading Data using SCSI 86
 - Connecting to an external device 86
 - Formatting a backup disk 86
 - Saving data to a SCSI disk 87
 - Loading from a single SCSI disk 89
 - Loading from more than one disk 90
- Save/Load a WAV File 92
 - Saving a WAV file 93
 - Loading a WAV file 96

SETUP Mode

- To enter the SETUP mode 99
- Time Signature Setting 99
 - New Registering of Time Signature 99
 - Correcting the Registered Time Signature 100
 - Deleting of Time Signature 100
 - Clearing All Time Signature data 100
 - Changing the Bar Offset Figure 100
- Setting a Tempo 101
 - New Registering of Tempo 101
 - Correction of the Registered Tempo 102
 - Erasing of the Registered Tempo 102
- Setting the Metronome function 102
- Setting MIDI sync output signal 103
- Setting an MTC frame rate 103
- Setting an MTC offset value 104
- Setting MTC offset mode 104
- Setting the Slave mode 105
- Setting the Slave type 105
- Setting the Record Protect function 106
- Setting Digital Input 107
- Setting BAR/BEAT Resolution mode 107
- Setting the MIDI device number 108
- Checking the number of track events 108
- The Drive Format Information 109
- Drive Setting 109
- Fader Fix mode Setting 110
- Fader Recall mode Setting 110

Others

- MIDI Implementation Chart 111
- MMC Command List 112
- Inquiry Message List 112
- Maintenance 113
- Specifications 113
- Block Diagram 114
- Installing the Model 8340 SCSI card 115

Basic Features of VF08

The VF08 Digital Multitracker incorporates a digital mixer with an 8-track (plus 16-additional track) digital recorder.

The digital mixer section features a high-performance DSP multi-effect processor employing the A.S.P. (Fostex Advanced Signal Processing) technology originally developed by Fostex. The digital recorder section allows you to record and playback uncompressed linear 16-bit/44.1 kHz digital audio.

You can make all process for music production such as overdubbing, track bounce, effect processing, mixdown and mastering in the digital domain without sound deterioration.

Product Features

Mixer Section

- Built in a high-performance DSP multi-effect processor employing the A.S.P. (Fostex Advanced Signal Processing) technology
- 7 track faders and a stereo master fader allow you to control signal levels intuitively.
- The track ON/OFF switch is provided for each track. The 2-band EQ with the EQ library and the effect send with PRE/POST selection are provided for Tracks 1 through 6.
- Both balanced (XLR) and unbalanced (1/4" phone) connectors are provided for each analog input. The phantom power is also available when using the balanced connector. Also the trim knob on each input makes it possible to accept a wide range of input signals from microphone to line levels.
- "Bounce" function allows bouncing signals from tracks 1 through 6 to tracks 7/8 with a single key operation.
- "Mastering effect" allows effect processing for the master tracks (7/8).
- "Training mode" helps you to practice your instrument by slowing down playback, shifting the pitch of the recorded performance or masking the solo instrument/voice.
- "Scene memory" function allows you to save and load up to 99 mixer scenes including fader positions and EQ/effect settings.
- You can feed the mixed-down signal from the S/PDIF output connector to an external digital device such as a DAT recorder for digital recording.

Recorder Section

- Employs the Fostex original FDMS-3 (Fostex Disk Management System-3) format, allowing high quality recording/playback with uncompressed linear 16-bit/44.1 kHz digital audio on 8 tracks, as well as 16 additional tracks. You can record about 3 hours of mono audio per 1 GB disk space.

- Nondestructive audio editing functions such as copy, paste, move, erase and undo/redo are possible.
- The "Program" function allows you to give a title to each song and manage up to 99 titles.
- +/- 6.0% pitch control.
- Accepts S/PDIF digital signal and records it directly onto any VF08 track.
- The auto punch in/out function with rehearsal mode. The IN and OUT points can be set with 1/100 frame accuracy. You can also carry out punch in/out manually using the foot switch.

Others

- Dot-matrix LCD and self-illuminating keys allow you to know the current status visually, as well as to make settings of the mixer and recorder easily.
- Durable and reliable 3.5-inch E-IDE standard hard disk is built in.
- Optional SCSI card (Model 8340) allows save/load of all VF08 data (both recorder and mixer data) using an external SCSI device.
- Save/load of song data using the S/PDIF (optical) signal is possible.
- Feeds MIDI clock with song position pointer or MTC (MIDI Time Code).
- Supports MMC (MIDI Machine Control).
- Can be slaved to an external MTC.
- The internal metronome function can be used for recording a guide track.
- The bar/beat resolution function allows editing by beat (the clock digit is omitted).
- Up to 99 mark points can be set per each song. You can locate any mark point or make the mark map of a scene.

Precautions

About power supply

- Be sure to connect the VF08 to the power supply specified in the Specifications section of this owner's manual. Do not use an AC outlet of any other voltage.
- Do not connect the VF08 to the same AC outlet to which devices that could generate noise (such as a large motor or dimmer), or the devices that consume a large amount of power (such as an air conditioning system or large electric heater) are connected.
- If you use the VF08 in an area with a different power voltage, first consult your dealer or the nearest Fostex service station. You can use the VF08 with a power frequency of 50Hz or 60Hz.
- It is very dangerous to use a power cord that is frayed or damaged. In such a case, stop using the VF08 immediately and ask your dealer to repair the cord.
- To avoid possible electric shock and damage to the VF08, avoid contact with water or other liquids, or do not handle the power plug while your hands are wet.
- To prevent possible electric shock and damage to the VF08, do not remove the main unit cover or reach the inside the VF08.
- Do not let water or other liquid, or metal objects such as pins, accidentally enter the inside of the VF08 because this may lead to electric shock or damage. Should water enter the inside of the VF08, remove the power plug from AC outlet, and consult your dealer or the nearest FOSTEX service station.
- To prevent damage to the VF08, be sure to power on the connected devices first, then turn on the power to the VF08. When you remove or connect the cables to the input/output connectors on the VF08, make sure that the track and master faders and volume controls are set to "0."

Important!

Equipment name, electrical ratings, serial number and other information for the VF08, are written on bottom side.

FOSTEX MODEL VF08		
DIGITAL MULTITRACKER		
FOSTEX	18W	50/60Hz
230V~		
SERIAL NO.	MADE IN CHINA	
FOSTEX CORP.		

Delay of display indication

- While using the VF08, you may have an experience to see the delay of the reaction of the time counter or level meters. This is not a malfunction and it bears no relation to the actual sound to be recorded or played.

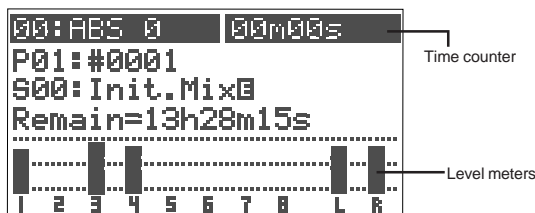

This kind of delay is due to the VF08 design concept in which the audio processing takes priority over the display processing when the audio processing gets busy (e.g. when a sudden fader level change happens). You may always trust the VF08 to record or playback audio in good condition.

Precautions upon handling the HD

- Before turning the power off to the VF08, first quit setup mode and make sure that the recorder section is stopped. Especially, never attempt to turn off the power to the VF08 while the hard disk is accessing data (the HD ACCESS LED is lit or flashing). Otherwise, not only will you lose recorded data, but you may damage to the VF08. Fostex is not responsible for the data lost during operation of the VF08.
- Before you change the location of the VF08, pack the unit in the shipping carton or an impact-resistant case. Make sure that the VF08 is kept free from external vibration or impact since the VF08 is very sensitive to vibration.
- Do not install the VF08 in locations subject to the following:
 - * Extremely high or low temperature, or significant changes in temperature.
 - * Excessive humidity or dust.
 - * Excessive changes in power supply voltage.
 - * Unstable or significantly vibrating or shaking surfaces.
 - * Near a strong magnetic field (such as a TV or speaker).
- If you move the unit from a place with an excessively low temperature to a warm place, or if you use the VF08 in a room in which the temperature varies significantly during winter, condensation may occur on the hard disk or other parts. In such cases, leave the VF08 for about an hour in the new location before you turn on the power.

Note on repair

- The VF08 does not use any parts that user can repair easily. Contact your dealer or the nearest FOSTEX service station to ask about repairs.
- Use the packing carton designed for the VF08 when you transport the VF08 to the dealer for repair or return. If you have discarded the packing box, try to pack the VF08 completely using shock absorbing materials. Fostex is not responsible for malfunction or damage due to incomplete packaging or caused during transport.

About copyrights

- It is prohibited by law to use any part of a CD recording or video images or audio data for which copyright is possessed by a third party for commercial purposes such as contents, broadcasts, sales, or distribution-any purpose other than for your personal pleasure.

About damage

- Fostex is not responsible for any "direct damage" or "indirect damage" caused by using the VF08.

Before Operating

This section describes the basics that you should know before you start operating the VF08. All users, including those who are familiar with using tape-based Multitracker and those who are new to Multitracker, should read this section thoroughly to understand the functions of the VF08.

Recording method

The VF08 uses a hard disk as a recording medium, instead of a conventional tape.

You can start recording sound sources from any point on a disk as long as the point is within the range of 24 hours in ABS time. Also you locate any point within the range. You may think of the VF08 as incorporating tapes on which 24-hour time information is striped.

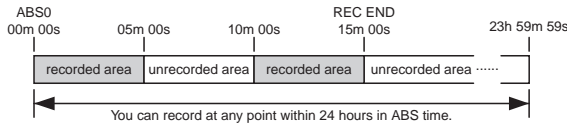

You can record in any area within 24 hours in ABS time.
 ABS 0: The beginning time at 00H 00M 00S
 REC END: The end time of recording (in the example above, 00H 15M 00S)

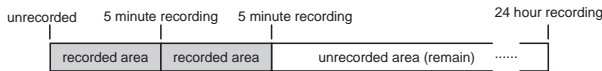

With a tape recorder, the maximum recording time depends on the tape length, regardless of the amount of unrecorded areas. With the VF08, you can use the media more efficiently because no disk space is used for unrecorded areas.

Program

You can use up to 99 "tapes with 24-hour time information" with the VF08. Each "tape" is called a "Program".

A program exists independently on the hard disk, therefore, you can freely record, playback or edit each program without affecting other programs.

You can give a name (program title) to each program, so you can easily identify a program.

"Program title" with its program number appears at the top left of the normal screen as shown below.

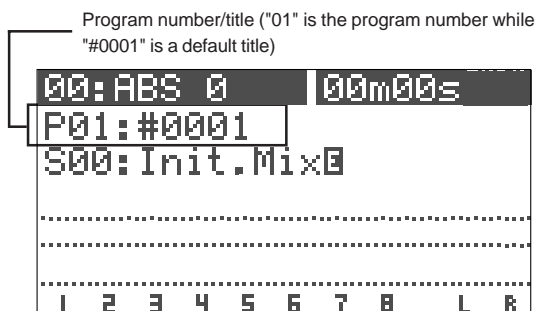

Remain indicator

The remain indicator shows how much recording time is left on the current hard disk.

The VF08 program is managed by a 24-hour time counter, however, the actual recording time left depends on the available disk space.

The remain indicator appears on the LCD during recording (or on REC standby), showing the rough remaining time if you record on a mono track.

Note that if the remaining time is 100 hours or more, the indicator shows the available (remaining) disk space in MB.

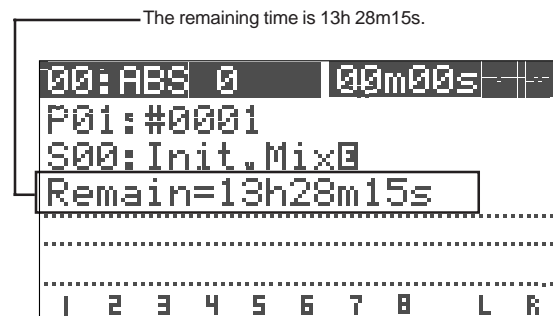

The remaining value is calculated on a mono-track basis. That is, the value indicates recordable time if you record on a mono track. You can calculate the recordable time when recording on more than one track easily by dividing the time by the track number.

In the example above, if you record on 2 tracks, the recordable time is about 6 hours 44 minutes (13 hours 28 minutes 15 seconds divided by 2). Or if you record on 8 tracks, the recordable time is about 1 hour 41 minutes (13 hours 28 minutes 15 seconds divided by 8).

The VF08 manages up to 99 programs on the hard disk. Each program includes not only the recording data but also various setting information which consumes a small amount of disk space. Therefore, note that the remaining time shown on the screen is a rough value.

Always check the remaining time left before starting recording, to ensure that you have enough disk space to work with.

Additional track

A program on the VF08 consists of 24 tracks. Tracks 1 through 8 are called "Real tracks" which you can record, playback and edit. Tracks 9 through 24 are called "Additional tracks". Using the "Track Exchange" function, you can exchange between "real track(s)" and "additional track(s)" in one-track, 2-track or 8-track block.

This makes it possible to record solo on several tracks, exchange tracks and compare the results, or to record different rhythm versions using multiple tracks, exchange the rhythm tracks completely and making a remix version.

Note that tracks 9 through 24 cannot be recorded, played or edited. The tracks you want to work with must be set as tracks 1 through 8.

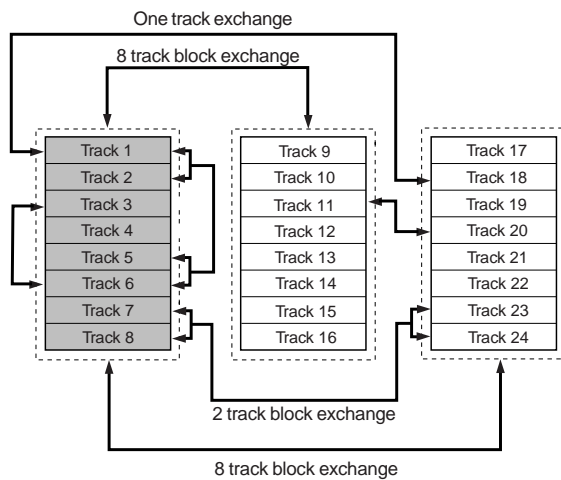

Input monitor and Repro monitor

There are two modes for monitoring a track of the VF08 ; "Repro monitor" and "Input monitor".

"Repro monitor" means that the track playback signal is monitored.

"Input monitor" means that the input source of the track is monitored. You can check the signal level for recording in this mode.

Input monitor is only available for tracks to be recorded (on REC standby) or currently being recorded.

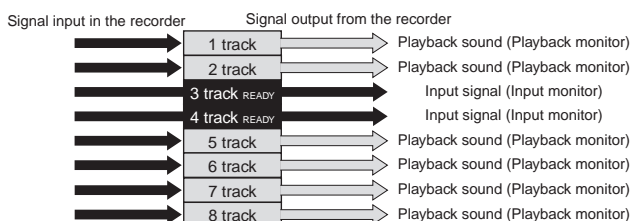

Event

Each time you make a recording, an independent audio file is created on each recorded track. A silent part on a track is also recognized as a file. These files (audio files and silent files) are called "events".

With the VF08, you can create up to 512 events per track. You cannot make any further recording when 512 events are created. In the normal use, 512 events are enough.

The VF08 can show the current number of events on the LCD. It also shows a warning message if you are going to make recording when 512 events already exist. You may resolve this problem by saving the program (see "Save/Load of a program").

Let's count the events for each recording step (A through E) below.

- A. Before recording, there is a single event (silent file) on the track (the VF08 recognizes a silent part as a file).
- B. After making a recording (REC B), there are two events on the track; the recorded audio file and the following silent part.
- C. After making another recording (REC C) continuously from the end point of REC B, there are three events on the track; two audio files and the following silent part.
- D. After locating a point ahead of REC C and then making another recording (REC D), there are totally five events on the track. Note that a silent file is created between REC C and REC D.
- E. After making a recording (REC E) over REC B and REC C, there are four events on the track.

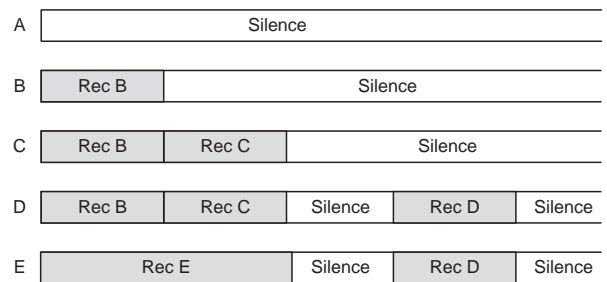

Trim

It is important to set the analog input level appropriately when converting an analog input signal from [INPUT] A or B into a digital signal (A/D conversion). You can adjust the analog level using the [TRIM] control. The [PEAK] indicator lights if the level is too high.

If the [TRIM] setting is not appropriate and the analog input level is too high (if the PEAK indicator lights), the signal will be converted into a distorted digital signal, resulting digital noise. You cannot eliminate this distortion/noise from the sound in the following stages. Therefore, be sure to adjust the level appropriately using the [TRIM] knob not to light the [PEAK] indicator when receiving the loudest audio input signal.

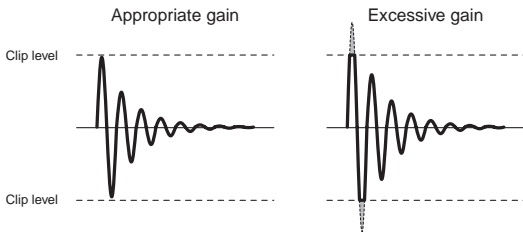

Time Base

The term "Time base" frequently appears in this manual. The time base is used to show the location in the recorder, like the "tape counter" of conventional tape recorders.

There are three types of time bases:

1. ABS (Absolute time)
2. Bar/Beat/Clk (Bar/Beat/Clock)
3. MTC (MIDI Time Code)

You can switch between these time bases by pressing the [TIME BASE SEL] key.

The ABS shows the absolute time of each program and is striped from 00h00m00s (=ABS 0) to 23h59m59s when a program is created.

The example below shows the current recorder position is at 00m (minute) 00s (second) 00f (frame). The hour digit appears only when the ABS time exceeds 01h00m00s00f.

ABS 0 is the reference position for managing all the location and related to other time bases.



Bar/Beat/Clk shows the musical position generated from the internal tempo map of the VF08 (including time signature and tempo).

The example below shows the current recorder position is at beat 1 of bar -2.

This position (beat 1 of bar -2) corresponds to ABS 0 and the following bar/beat numbers are determined according to the time signature and tempo settings.



Beat 1 of bar -2 corresponds to ABS 0 as the default setting, however, you can change to set it between bar -9 and bar -2.

MTC (MIDI Time Code) runs in sync with the ABS time. The MTC value (**h**m**s) corresponding to ABS 0 can be set, which is called "MTC offset".

If you set the MTC offset to 01h00m00s, the MTC will start from 01h00m00s, and at the ABS 01h00m00s position, the MTC value will be 02h00m00s.

The example below shows that the current position is at MTC 00h59m57s.



The default MTC offset is 00h59m57s00f00sf. You can change the offset to any time value of 24-hour clock.

It is also possible to set the MTC offset by setting the MTC value corresponding to "beat 1 of bar 1" instead of "ABS 0".

The following diagram illustrates the relationship between the three time bases.

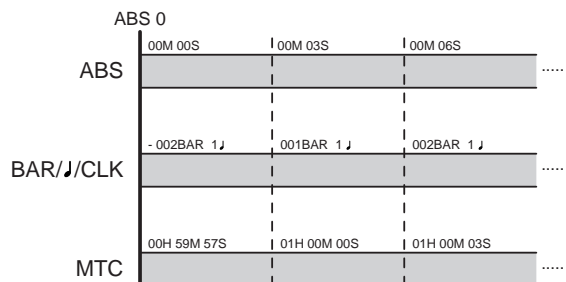

Names and Functions

Top panel

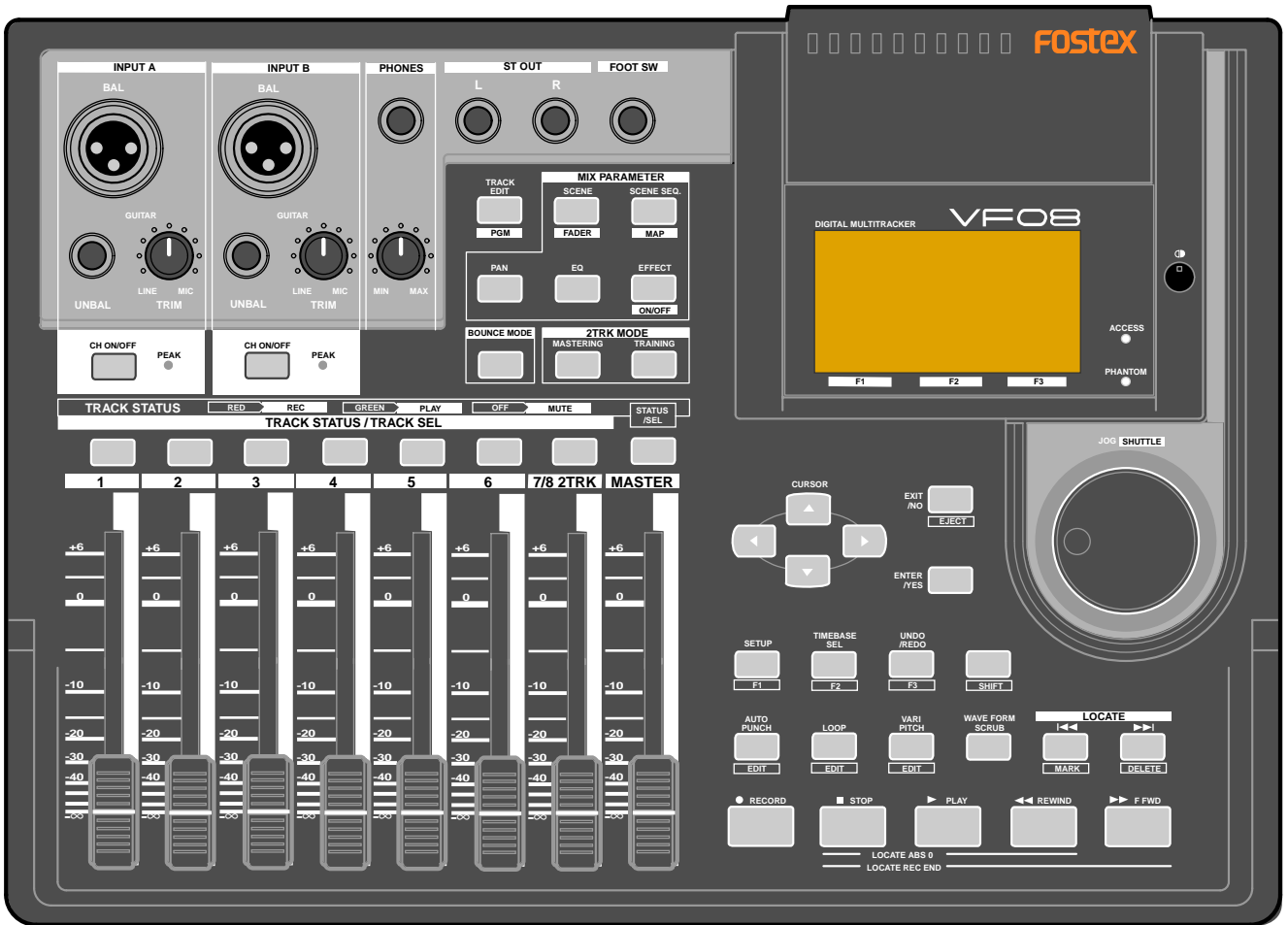

Rear panel

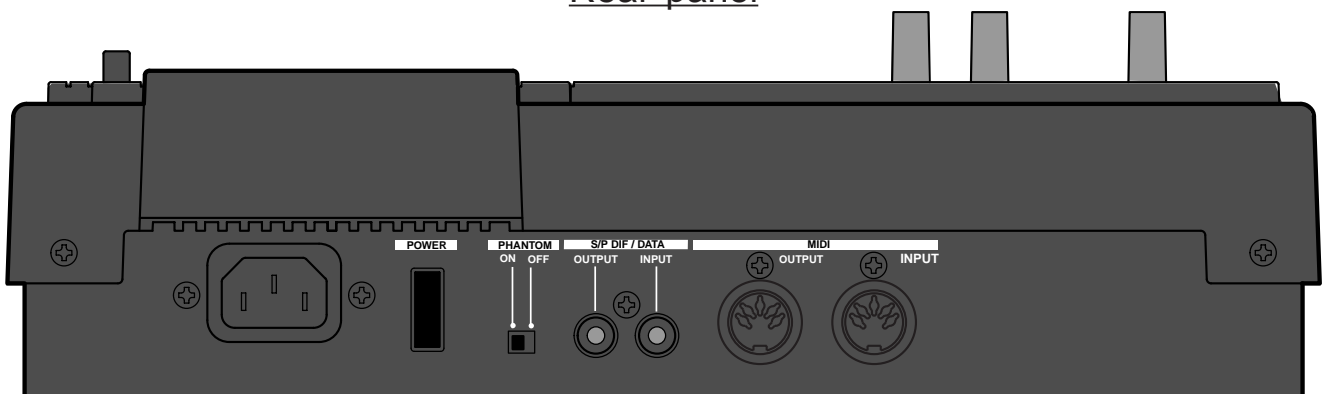

Top panel (Analog input/output section)

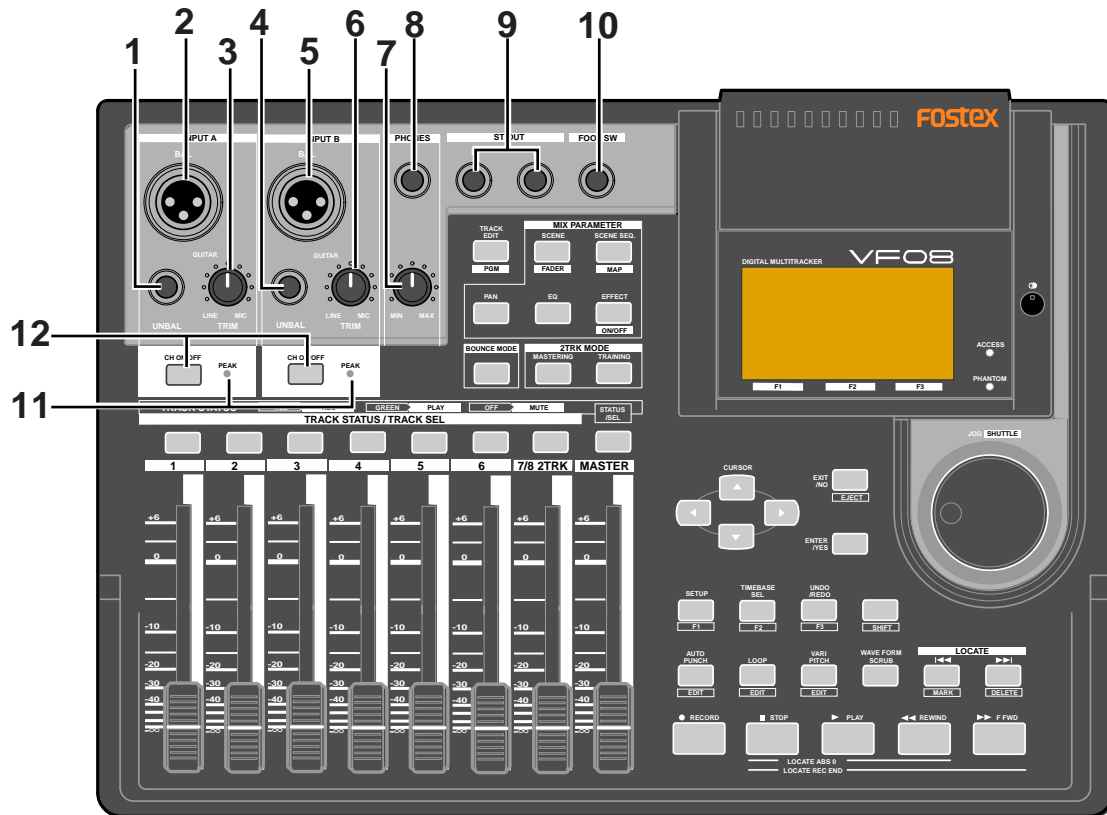

1. [INPUT A/UNBAL] (Unbalanced) connector
 - * Connects to the unbalanced output of an external sound source.
 - * Reference input level: -50 dBV to +2 dBV
 - * Connector type: phone jack
 - * When this connector is plugged, the input from the [INPUT A/BAL] connector is interrupted.
2. [INPUT A/BAL] (Balanced) connector
 - * Connects to the balanced output of an external sound source.
 - * Reference input level: -50 dBV to +2 dBV (approx. -48 dBu to +4 dBu)
 - * Connector type: XLR-3-31 type (pin #2 hot)
 - * A phantom power (+48 V) can be supplied for using a condenser microphone by setting the [PHANTOM] switch on the rear panel to ON.
 - * When the [INPUT A/UNBAL] connector is plugged, the input from this connector is interrupted.
3. [INPUT A/TRIM] knob
 - * Controls the gain according to the signal from [INPUT A].
 - * You can adjust the gain to accept input signals between -50 dBV (MIC) and +2 dBV (LINE).
4. [INPUT B/UNBAL] (Unbalanced) connector
 - * Connects to the unbalanced output of an external sound source.
 - * Reference input level: -50 dBV to +2 dBV
 - * Connector type: phone jack

- * When this connector is plugged, the input from the [INPUT B/BAL] connector is interrupted.
5. [INPUT B/BAL] (Balanced) connector
 - * Connects to the balanced output of an external sound source.
 - * Reference input level: -50 dBV to +2 dBV (approx. -48 dBu to +4 dBu)
 - * Connector type: XLR-3-31 type (pin #2 hot)
 - * A phantom power (+48 V) can be supplied for using a condenser microphone by setting the [PHANTOM] switch on the rear panel to ON.
 - * When the [INPUT B/UNBAL] connector is plugged, the input from this connector is interrupted.
 6. [INPUT B/TRIM] knob
 - * Controls the gain according to the signal from [INPUT B].
 - * You can adjust the gain to accept input signals between -50 dBV (MIC) and +2 dBV (LINE).
 7. [PHONES] (Headphones) knob
 - * Adjusts the level of headphones for monitoring.
 8. [PHONES] (Headphones) connector
 - * Connects headphones for monitoring.
 - * Connector type: TRS phone jack
 9. [ST OUT L. R] (Stereo out) connector
 - * Outputs the stereo (L and R) buss signal.
 - * Connects to a master recorder, etc.
 - * Reference output level: -10 dBV

- * Connector type: phone jack
 - 10. [FOOT SW] (Foot switch) connector
 - * Connects to an optional foot switch (Model 8051) for punch in/out operation.
 - * Connector type: phone jack
 - 11. [PEAK] indicators
 - * Each indicator lights up when the corresponding input signal reaches the clipping level.
 - * Set the [TRIM] knob properly not to light the indicator.
 - 12. [CH ON/OFF] keys
 - * Each key is used to turn on and off of the corresponding channel. When on, the key illuminates.
- See the following description for details about how to use each element.

Top panel (Mixer section)

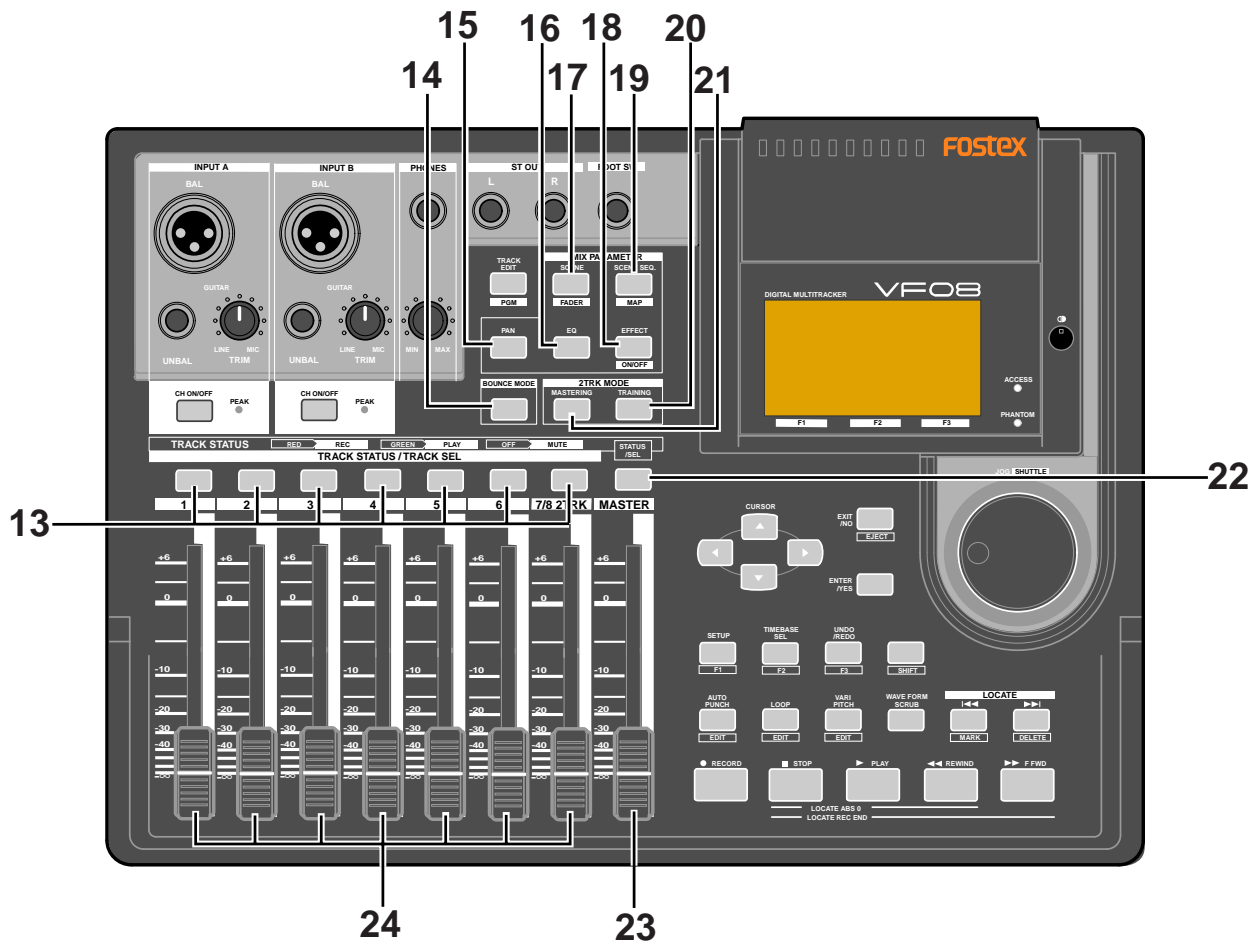

- 13. [TRACK STATUS/TRACK SEL] keys
 - * While stopped, each key is used to change the track status among OFF, PLAY and REC (READY). During playback, pressing the key switches between OFF and PLAY.
 - * During recording, you cannot change the track status.
 - * When you view or edit mixer parameters such as pan and EQ in the "Mix parameter edit" mode (described later), you can select the target track by pressing the corresponding [TRACK STATUS/TRACK SEL] key.
 - * The illumination of each key shows the track status as follows.
 - flashing in red: the track is in REC READY.
 - lighting in red: the track is being recorded.
 - lighting in green: the track can be played back.
 - not lighting (off): the track is muted.
- 14. [BOUNCE MODE] key
 - * Turns the bounce mode on or off.
 - When on (the key lights), tracks 7-8 are automatically armed for recording, allowing track 1 through 5 signals to bounce to track 7 and 8.
- 15. [MIX PARAMETER-PAN] key
 - * When viewing or editing the pan pot setting, press this key.
 - * Select the track to be viewed or edited by pressing the corresponding [TRACK STATUS/TRACK SEL] key.
- 16. [MIX PARAMETER-EQ] key
 - * When viewing or editing the EQ setting, press this key.
 - * Select the track to be viewed or edited by pressing the corresponding [TRACK STATUS/TRACK SEL] key.

Names and functions

17. [MIX PARAMETER-SCENE / FADER] key

- * When storing, recalling or deleting a scene memory, press this key.
- * To view track fader positions, press this key while depressing the [SHIFT] key.

18. [MIX PARAMETER-EFFECT / ON/OFF] key

- * When selecting the internal DSP effects, adjusting the effect send levels, selecting pre or post of the effect send, or setting effect parameters, press this key.
- * Select the track to be viewed or edited by pressing the corresponding [TRACK STATUS/TRACK SEL] key.

19. [MIX PARAMETER-SCENE SEQ. / MAP] key

- * Turns on or off the scene sequence mode.
- * When editing the scene sequence map, press this key while depressing the [SHIFT] key.

20. [2TRK MODE-TRAINING] key

- * Turns on or off the "Training mode" in which only tracks 7-8 are played back. When the mode is active, the key lights up.

21. [2TRK MODE-MASTERING] key

- * Turns on or off the "Mastering mode" in which tracks 7-8 are played back with the mastering effects. When the mode is active, the key lights up.

22. [STATUS/SEL-MASTER] key

- * Turns on or off the master channel.
- * Also used to select the track for the mix parameter edit.

23. [MASTER] fader

- * Adjusts the output levels of the stereo L/R busses.

24. Track faders

- * Adjusts the playback levels of the tracks 1 through 6 and 7-8.

Top panel (Recorder/Display section)

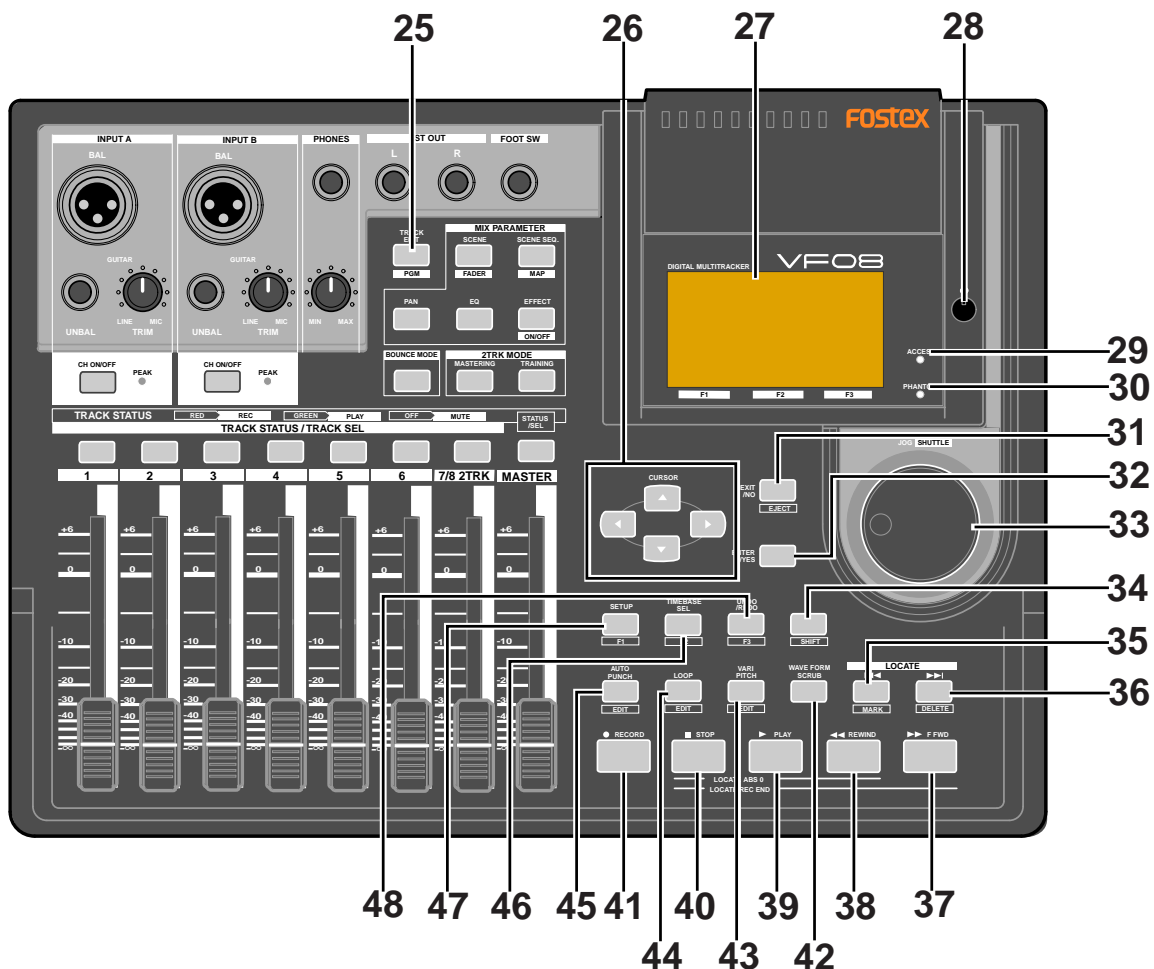

25. [TRACK EDIT / PGM] key

- * When editing audio of tracks such as copy/paste, etc., press this key.

There are four audio editing functions.

- copy
- move
- erase
- track exchange

- * Pressing this key while depressing the [SHIFT] key allows you to carry out the following program-related functions.

- creating a new program
- selecting a program
- editing a program title
- deleting a program

26. [CURSOR left/right/up/down] keys

- * Used to move the edit point in edit or setup mode.

27. LCD (Liquid Crystal Display)

- * Displays the recorder or mixer status or parameters.

28. Contrast adjusting knob

- * Adjusts the LCD contrast.
Turning the knob clockwise makes the contrast higher, while turning it counterclockwise makes it lower.

29. [ACCESS] indicator

- * Lights up while the internal hard disk drive or external backup SCSI device is writing or reading data.

<Caution>

Do not turn off the VF08 power while this indicator lights. Data recorded in the disk may be erased.

30. [PHANTOM] indicator

- * Lights up when the phantom power is supplied.
You can switch the phantom power on or off by the [PHANTOM] switch on the rear panel.

31. [EXIT/NO / EJECT] key

- * Used to cancel or interrupt SETUP menu settings or audio editing functions such as Copy and Paste.
The opposite of the [ENTER/YES] key.
- * When the optional SCSI card (Model 8340) is installed and an external SCSI device is connected, while "SCSI" is selected in the "Drive setting" menu, pressing this key while holding down the [SHIFT] key removes a removable disk for backup.

32. [ENTER/YES] key

- * Used to execute SETUP menu settings or audio editing functions such as Copy and Paste. The opposite of the [EXIT/NO / EJECT] key.

33. [JOG / SHUTTLE] dial

- * When the [WAVE FORM SCRUB] key is illuminated, after pressing any of the [TRACK STATUS/TRACK SEL] keys, rotating this dial scrubs audio digitally with no pitch change for both forward and backward directions.
- * Used to change a parameter value in the edit mode.
- * Pressing this dial while holding down the [SHIFT] key moves the position forward or backward at 1x to 64x

speed depending on the rotating direction and degree.

34. [SHIFT] key

- * Used to activate the second (shifted) functions of keys and a dial. Each shifted function is labeled in a while-line boxes on the panel.

35. [LOCATE << / MARK] key

- * Each press of this key locates the previous mark point.
- * Pressing this key while holding down the [SHIFT] key stores the current position in the mark map.

36. [LOCATE >>] / [DELETE] key

- * Each press of this key locates the next mark point.
- * Pressing this key while holding down the [SHIFT] key delete the current mark point directly.

37. [F FWD >>] key

- * Pressing this key while stopped fast-forwards the position at 30x speed.
- * Pressing this key during playback moves forward the position at 3x speed with audible cue.
- * Pressing this key while holding down the [STOP] key executes the "LOCATE REC END" function (locates the last recording position of the current program).

38. [REWIND <<] key

- * Pressing this key while stopped rewinds the position at 30x speed.
- * Pressing this key during playback moves backward the position at 3x speed with audible cue.
- * Pressing this key while holding down the [STOP] key executes the "LOCATE ABS 0" function (locates the beginning of the current program).

39. [PLAY] key

- * Pressing this key starts the recorder playback.
- * Pressing the [RECORD] key while holding down this key (or pressing this key while holding down the [RECORD] key) starts recording of the armed (REC READY) track(s).
- * Pressing this key alone during recording punches out (releases recording).
- * Pressing this key while holding down the [STOP] key locates the last playback position.

40. [STOP] key

- * Pressing this key during playback, recording, fast-forward or rewinding stops the recorder running.
- * Also used to cancel or interrupt SETUP menu settings or audio editing functions such as Copy and Paste.
- * Pressing the [F FWD] or [REWIND] key while holding down this key executes the "LOCATE REC END" or "LOCATE ABS 0" function.
- * Pressing the [PLAY] key while holding down this key locates the last playback position.
- * Pressing the [RECORD] key while holding down this key locates the last recording position.

41. [RECORD] key

- * Pressing the [PLAY] key while holding down this key (or pressing this key while holding down the [PLAY] key) starts recording of the armed (REC READY) track(s).
- * Pressing this key alone switches the monitor of the armed track (s) to Input monitor (the [RECORD] key flashes).

Names and functions

Pressing this key again switches the monitor back to Repro monitor.

- * Pressing this key while holding down the [STOP] key locates the last recording position.

42. [WAVE FORM SCRUB] key

- * Pressing this key enters the scrub mode. In the scrub mode, you can scrub audio forward or backward digitally.

43. [VARI PITCH / EDIT] key

- * Pressing this key switches between On and Off of the vari pitch (vari-speed playback/recording) function. When the function is active, this key is illuminated.
- * Pressing this key while holding down the [SHIFT] key makes you ready to edit the pitch value via the screen.

44. [LOOP / EDIT] key

- * Pressing this key switches between On and Off of the loop mode. When the mode is active, this key is illuminated.
- * Pressing this key while holding down the [SHIFT] key makes you ready to edit the loop parameters (Start point and End point) via the screen.

45. [AUTO PUNCH I/O / EDIT] key

- * Pressing this key switches between On and Off of the auto punch mode. When the mode is active, this key is illuminated.
- * Pressing this key while holding down the [SHIFT] key makes you ready to edit the auto punch parameters (In point and Out point) via the screen.

46. [TIME BASE SEL / F2] key

- * Pressing this key switches the time base shown on the screen among the following.

a. ABS (absolute time):

Absolute time from 00h00m00s to 23h59m59s.

b. Bar/Beat/Clk (Bar/Beat/Clock):

Bar/Beat/Clock according to the time signature and tempo information set in the internal tempo map.

c. MTC (MIDI Time Code)

MTC with or without an offset to the ABS time.

- * When a key icon is shown above "F2" on the screen, pressing this key while holding down the [SHIFT] key executes the function directly.

47. [SETUP / F1] key

- * Pressing this key enters the setup mode for editing/setting the initial setting parameters of recorder and mixer.
- * When a key icon is shown above "F1" on the screen, pressing this key while holding down the [SHIFT] key executes the function directly.

48. [UNDO/REDO / F3] key

- * Pressing this key cancels the operation for the audio editing (Copy, Paste, etc.), auto punch in/out or recording, and returns to the previous condition. This is the "undo" function.
- * Pressing this key again returns to the condition before carrying out the "undo" function. This is the "redo" function.

- * When a key icon is shown above "F3" on the screen, pressing this key while holding down the [SHIFT] key executes the function directly.

In the example below, pressing the [SETUP / F1] key, [TIME BASE SEL / F2] key or [UNDO/REDO / F3] key executes "RECALL", "STORE" or "DELETE" respectively.

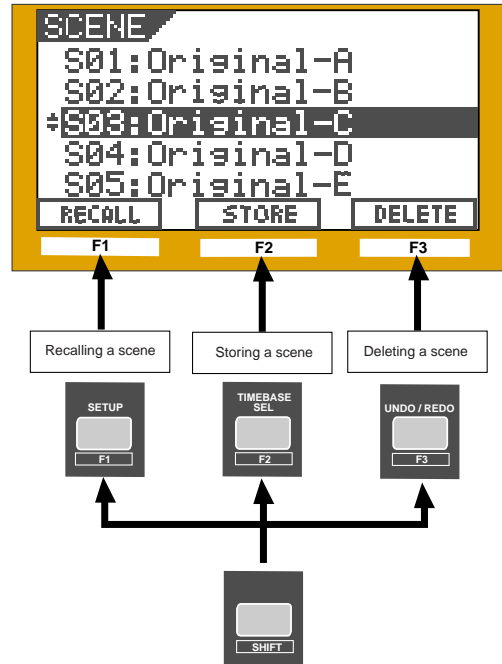

Rear panel

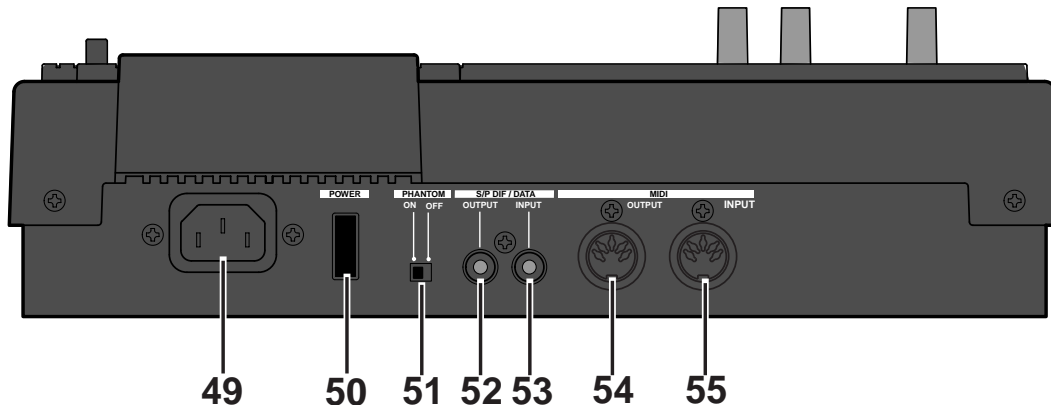

49. [AC IN] connector

- * Connects the supplied AC power cord. Make sure that the voltage of your AC outlet matches the specified voltage.

50. [POWER] switch

- * Turns on or off the power of the unit.

51. [PHANTOM] ON/OFF switch

- * When the switch is set to ON, the phantom power is supplied to the condenser microphone(s) connected to the [INPUT A/BAL] and/or the [INPUT B/BAL] connector(s).

52. [S/P DIF / DATA OUTPUT] connector

- * Outputs the S/P DIF digital signal. Used to connect to the coaxial (S/P DIF) digital input of an external digital device.
If the external device only provides the optical digital input, use the Fostex COP-1 coaxial/optical converter.
- * Connector: RCA pin jack

53. [S/P DIF / DATA INPUT] connector

- * Accepts the S/P DIF digital signal. Used to connect to the coaxial (S/P DIF) digital output of an external digital device. If the external device only provides the optical digital output, use the Fostex COP-1 coaxial/optical converter.
- * Connector: RCA pin jack

54. [MIDI OUTPUT] connector

- * Connects to the MIDI IN connector of an external MIDI device.
- * Mainly transmits MIDI information for synchronization such as MTC (MIDI Time Code) and MIDI clock with song position pointer.
- * Connector: DIN 5-pin type

55. [MIDI INPUT] connector

- * Connects to the MIDI OUT connector of an external MIDI device.
- * Mainly receives MIDI control information such as MMC (MIDI Machine Control).
- * Connector: DIN 5-pin type

See an appropriate section for the detailed information of each operation or function.

Side panel

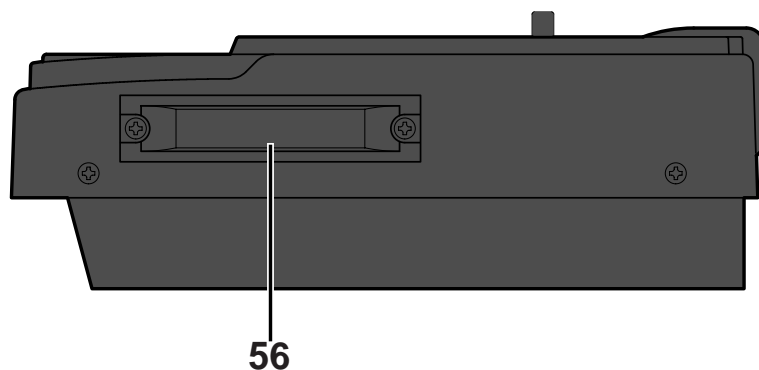

56. Slot for the optional card

- * You can install the Model 8340 optional SCSI card in this slot. By installing the SCSI card, you can save or load song data using an external SCSI device (MO, zip, etc.).

- * See page 115 for details about how to install the optional SCSI card.
If you want to know details about the option, contact your dealer or a Fostex sales office.

About the hard disk storage device

The VF08 is complete with a 3.5-inch E-IDE hard disk (storage device) which is formatted in the Master 8 mode. Therefore, there is no need to newly assemble a hard disk or to format the hard disk.

Reformatting the hard disk

This section describes how to reformat the hard disk. The VF08 adopts a “FDMS-3 (Fostex Disk Management System-3)” format which is a Fostex exclusive format. 24 additional tracks can be used in addition to recording and playing 8-tracks of uncompressed 44.1kHz/16 bit high quality sound.

<Precaution>

Note that, when you reformat your hard disk, you will erase all data saved or recorded on the hard disk, as well as all the settings made. Reformating your hard disk restore the VF08 back to the default setting. Always make a point to check that there is no data that you need remaining on the hard disk prior to reformating.

- 1 Turn ON the VF08.
- 2 Press the [SETUP] key. The system will go to the SETUP mode. The select display of the SETUP menu appears. (The highlight indicates the menu that is currently selected.)

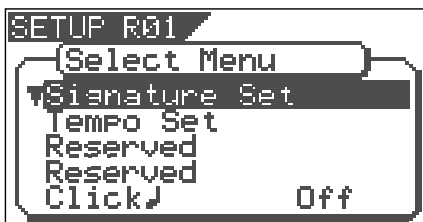

- 3 Turn the [JOG] dial to highlight the “Disk Format” menu title, press the [ENTER/YES] key. “IDE” indicates the current drive. “SCSI” indicates the backup SCSI drive.

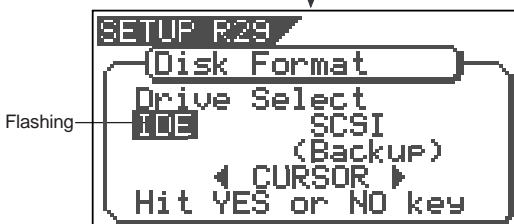
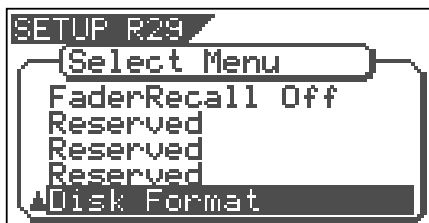

- 4 Press the [ENTER/YES] key while “IDE” is flashed. The menu to select the format type appears. The display will appear as follows, according to the previous format type. “*****” represents the name of the drive.

The hard disk formatted in the “Standard” type upon newly formatting the hard disk will show “Standard” and “Erase”. The hard disk formatted in the “Quick” type upon newly formatting the hard disk will show “Standard” and “Quick”. The user can select one.

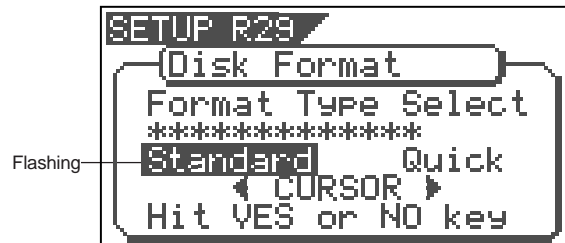

or

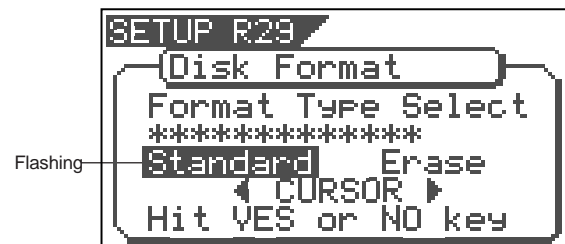

“Standard”	The hard disk is formatted with the access time of the unit sectors, while judging whether the sectors are good or bad. The formatting time tends to be longer with this type, however, the reliability is better. Therefore, it is recommended that this default format type is selected under normal conditions.
“Erase”	This choice is only available when a hard disk previously formatted in the “Standard” type is being reformatted. With this format, the “Standard” type is maintained, while all data on the hard disk are erased. The formatting time is shorter than the time required to format a “Standard” type.
“Quick”	This is a quick formatting procedure in which all hard disk sectors are considered to be good sectors. The formatting time is fast, however, the procedure cannot discover bad sectors. Therefore, it is recommended that this format type is only used when formatting a new hard disk that Fostex has already confirmed to operate normally.

- Select the format type with the [CURSOR </>] key. Then press the [ENTER/YES] key.
The format type selected is set and "Sure?" flashes.

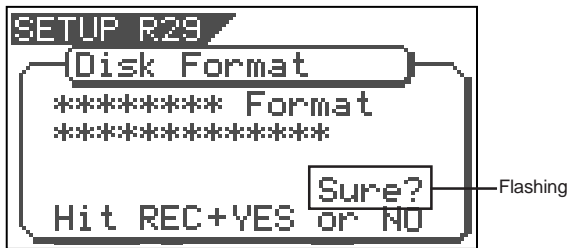

- Press the [ENTER/YES] key while the [RECORD] key is depressed.
If the "Standard" format is selected and executed, the formatting process takes place while showing the progress of the good sectors (Good ***MB) on the disk, bad sectors on the disk (Bad ***MB) and remainder (Remain ***MB).
Nothing can be done during the formatting process. Please wait for a while until the process is completed.

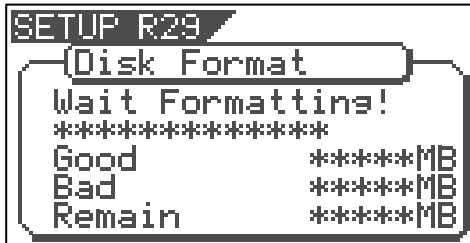

When the hard disk is successfully formatted (formatting completed), the number of sectors and noncontiguous sectors are shown after formatted, then "Completed!" lights up. Formatting is completed instantaneously if either "Erase" or "Quick" is selected and executed.
For this reason, the "Completed!" message lights up without showing the progress status while formatting is taking place.

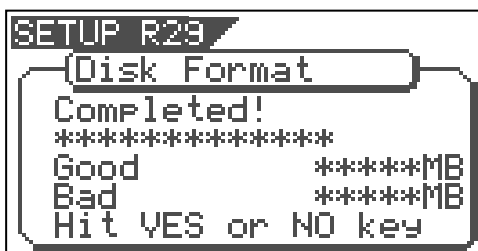

- Press the [EXIT/NO] key (or [STOP] key) to escape from the SETUP mode.
The Normal Screen appears indicating the beginning of the program (P01) that is automatically created after formatting the hard disk.

Replacing a hard disk

The user can immediately start recording with the VF08. Note that the current hard disk can also be replaced with another model for use with the VF08. (However, please only use hard disks that Fostex recommends.)

<Operation Confirmed HD List for the VF08>
The updated information on the operation-confirmed HD and backup media for VF08 is mentioned in the following Fostex international web site.

<http://www.fostex.co.jp/int/index.htm>

For those who are unable to check our web site, please contact the Fostex distributor in your territory.

<Warning>

This section describes the procedures to replace the hard disk. However, we recommended that the customer ask the Fostex Customer Service Department to replace the VF08 hard disk. Note that the product is not warranted for any malfunctions that may occur after the customer replaces the hard disk on their own. Also note that Fostex will not be held liable for any accidents that may occur during the replacement process or any hard disk damages, if the customer decides to replace their own hard disk on their own.

<Precautions Upon Replacement>

- * Always turn OFF the power of the VF08 and unplug the power plug from the electric outlet when replacing the hard disk.
- * Always place the hard disk on a flat and stable platform during the replacement process. Place a soft cloth under the unit to protect the product from scratching. Gloves are recommended to prevent any hand injuries.

<Precautions Upon Handling the Hard Disk>

- * A hard disk is an extremely sensitive precision device. Never expose the hard disk to "strong shocks" when replacing, assembling or handling. Never leave the hard disk by a device that generates strong magnetic fields.
- * Always set the DIP switch and Jumper of the newly assembled hard disk to the "MASTER" setting. The hard disk will not operate normally if the setting is set to "SLAVE" when the hard disk is assembled. Refer to the User's Manual of the hard disk for more details on the DIP switch and Jumper settings.
- * Note that the connector of some hard disks may be stiff, and thus make it difficult or impossible to insert or connect. Never apply excessive force to insert the connector in such case. Always make a point to gently insert the connector. Failure to do so may result in unexpected injuries or damage the hard disk.

About the hard disk storage device

- 1** Unscrew the four screws from the bottom of the main unit that are fixing the panel.

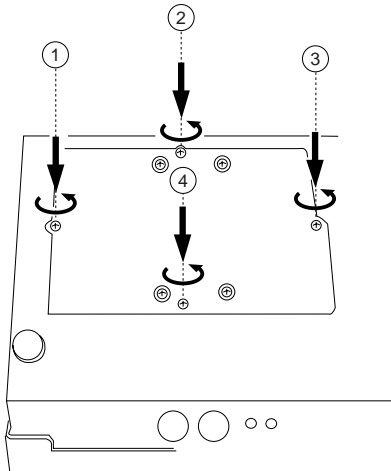

- 2** Turn over the panel that the hard disk is fixed according to the instructions shown in the figure below. Note that hard disk cables will be connected. Be careful not to apply excessive force when turning over the panel.

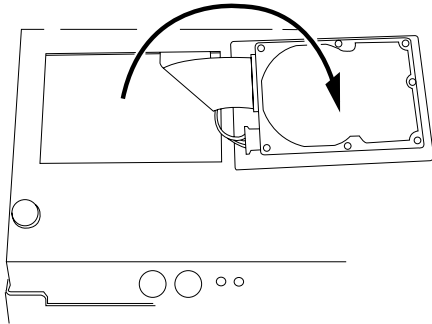

- 3** Remove the two cable connectors that are connected to the hard disk. Gently hold the connector and slowly pull out.

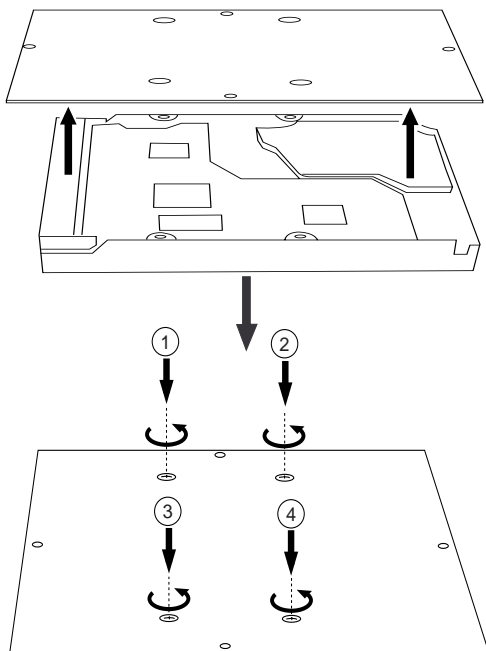

- 4** After disconnecting the cables, remove the panel that is fixing the hard disk. Unscrew the four screws with a screwdriver, as shown in the Figure.

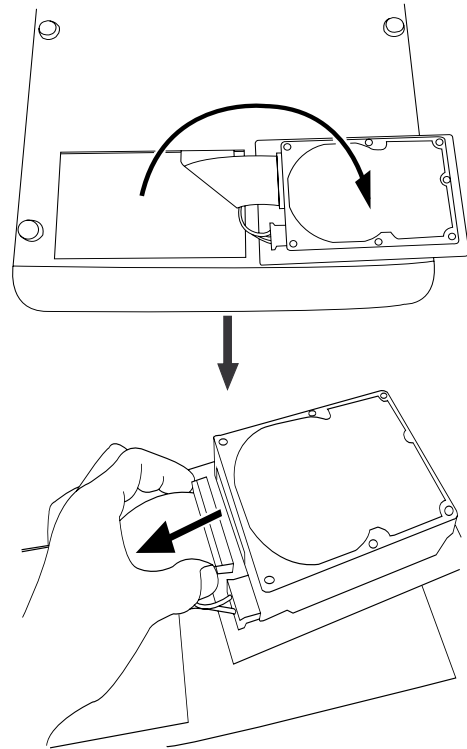

- 5** Fix a new hard disk to the panel in the reverse order of removing the hard disk as performed earlier. Connect the cables. Then house the hard disk at the bottom of the main unit. Follow the <Precautions> described earlier, and properly assemble the parts.

When the new hard disk is successfully assembled, go to the next section. Now, format the unformatted hard disk.

Formatting the Hard disk

Carefully follow the instructions below to newly format the hard disk properly.

- 1 Turn ON the VF08 after plugging the power cable in the electric outlet.
The VF08 will startup. "Unformat!" will appear on the LCD. The menu will automatically go to the SETUP mode.
The display showing the "Disk Format" menu appears.

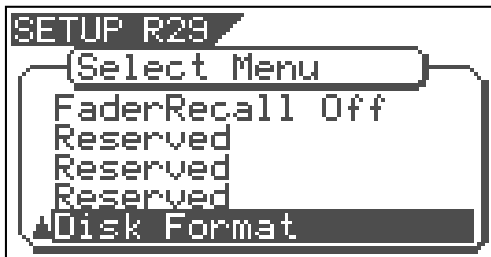

- 2 Press the [ENTER/YES] key.
The drive selection display appears.
"IDE" will be flashed.

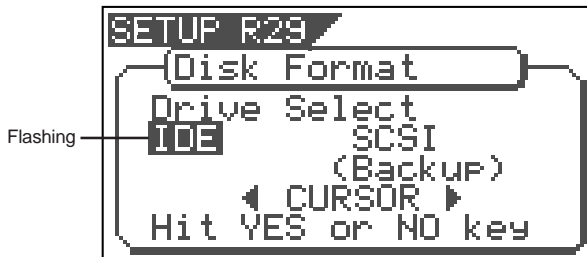

- 3 Press the [ENTER/YES] key where the "IDE" is flashed.
The menu to select the format type appears.
"****" represents the name of the drive.

<CAUTION>

Either the "Standard" or "Quick" format type can be selected. However, make sure that the "Standard" format type is selected when formatting a newly installed hard disk.

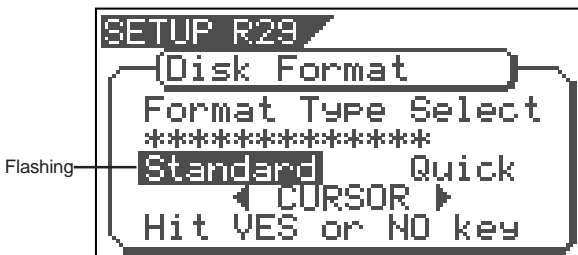

- 4 Press the [ENTER/YES] key where the "Standard" is flashed.
The format type selected is set and "Sure?" flashes.

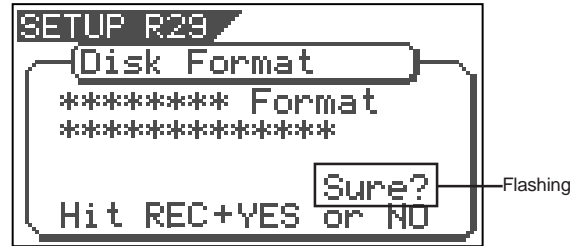

- 5 Press the [ENTER/YES] key while the [RECORD] key is depressed.
The formatting process is started. The formatting process will take some time.
When the formatting is successfully completed, "Completed!" will light up on the display.
- 6 Press the [EXIT/NO] key (or [STOP] key) to escape from the SETUP mode.
The Normal Screen appears indicating the beginning of the program (P01) that is automatically created after formatting the hard disk.



<Normal Screen>

Basic Recording and Playback

This chapter describes the basics of recording and playback audio using the VF08.

Connections of external equipment

You can connect various sound sources and external devices to the input and output connectors of the VF08 as shown in the example below. When making connection, make sure that the [MASTER] fader is set to the lowest (“∞”) position and the [PHONES] knob to the leftmost (“MIN”) position. Otherwise, your speakers or headphones may damage by the audio noise generated when connecting cables.

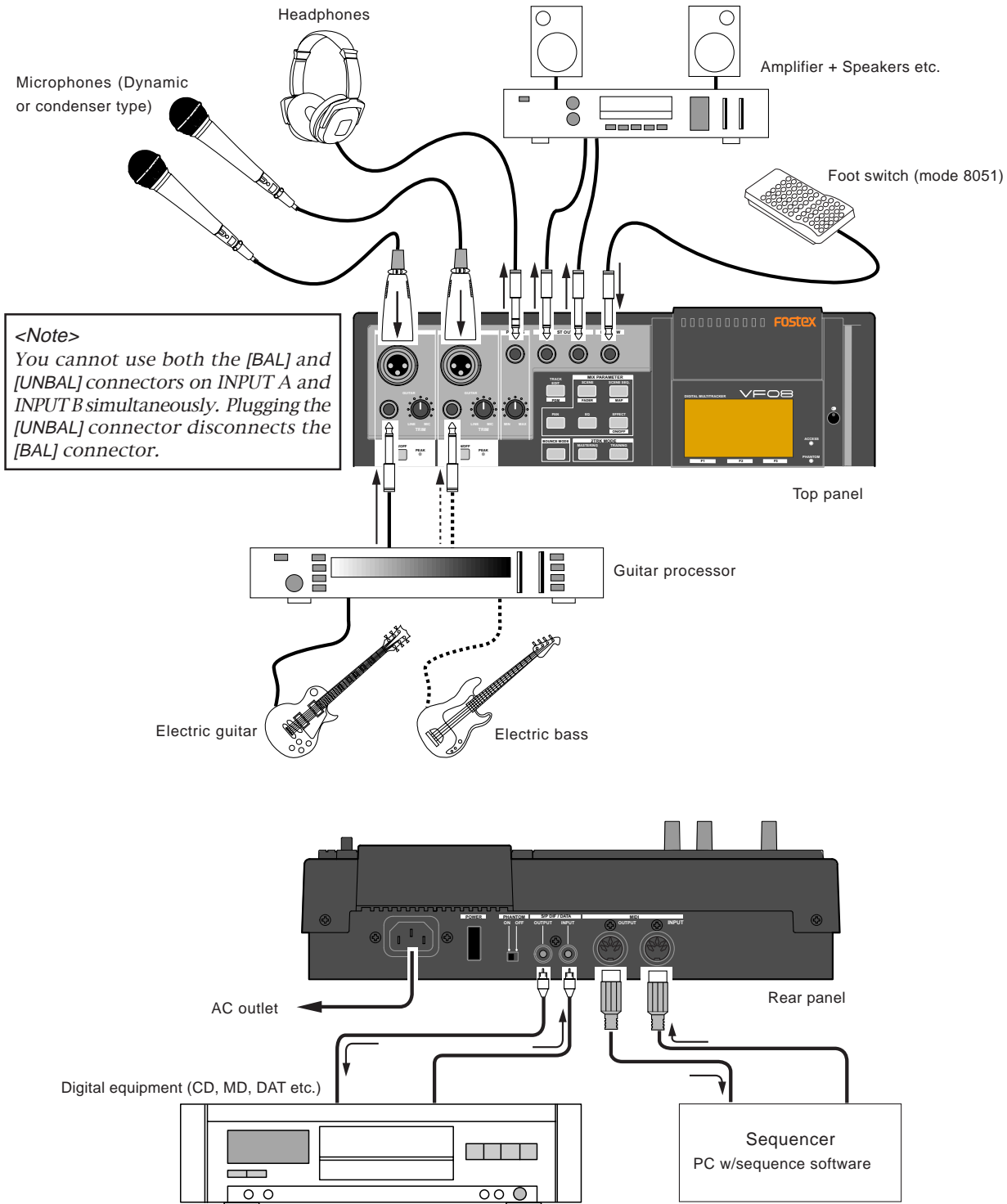

LCD

This section describes major contents on the LCD display and their operations.

Display when turning on the power

When turning on the power of the VF08 on which a formatted hard disk is installed, the unit starts up and “Initial..” and “version number” appears on the LCD display, followed by “Current Dr”, “IDE”, “hard disk name (momentarily)” and “record mode (Standard or Quick)”. Then the unit gets ready at the beginning (ABS 0) of the program which was selected when the power was turned off last time. The current position is shown by the time base previously selected. The display that appears when the unit gets ready is call “Normal screen”. The Normal screen shows the following items.



Screen example while starting up

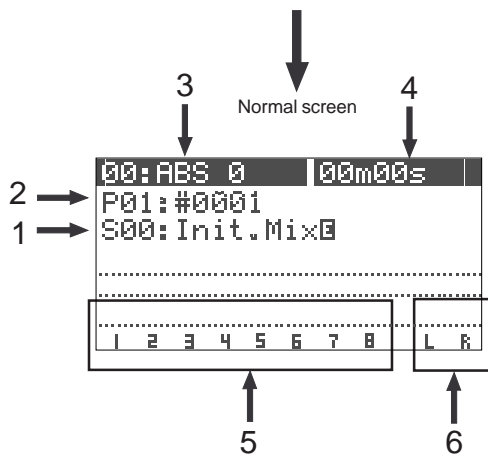

1. Scene number & name
With the initial setting, “S00: Initial Mix” appears.
2. Program number & name
With the initial setting, “P01: #0001” (#0001 is a tentative name) appears.
3. Mark number & name
With the initial setting, “00: ABS 0” appears, showing that the current location is at the beginning of the program. When the recorder starts running, “:” between the number and name is replaced with “+”.
4. Time base
With the initial setting, the ABS time base is selected. You can change the time base by using the [TIME BASE SEL] key (see the next section).
5. Level meters for Tracks 1 through 8
6. Master level meters for the Stereo output (L, R)

Switching the time base

Each press of the [TIME BASE SEL] key cycles the time base of the Normal screen between “ABS”, “BAR/BEAT/CLK” and “MTC”.

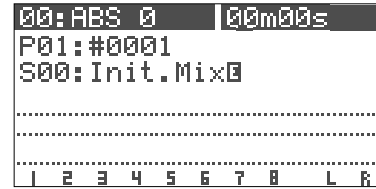

Normal screen with ABS time base

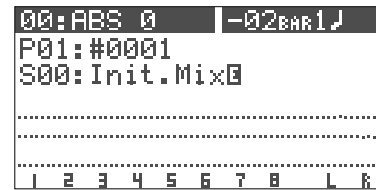

Normal screen with BAR/BEAT/CLK time base

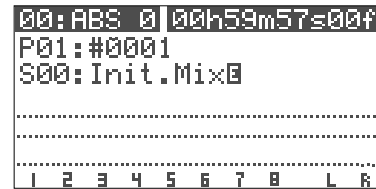

Normal screen with MTC time base

“Disk remain” indication

You can check the disk remaining space which shows the “recordable space left on the current disk”. The disk remaining space (REM) is shown during “Rec ready” or “Recording”, in “time” when the remaining time is less than 100 hours, or in “MB (Megabyte)” of the remaining space when it exceeds 100 hours. Note that the remaining time is shown as the recordable time when you record onto a single track. , you can calculate the recordable time for recording onto 8 tracks by dividing the displayed remaining time by 8.

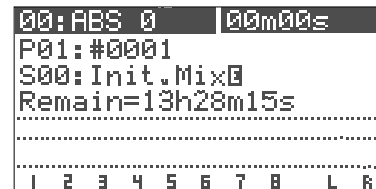

Remaining time displayed in time

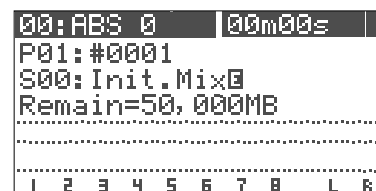

Remaining time displayed in MB

Preliminary knowledge

• Inputs and tracks

You can record onto adjacent two tracks (Tracks 1-2, 3-4, 5-6, or 7-8) or a mono track (one of Tracks 1 through 6). You cannot select another combination.

The input signal from INPUT A is fed to odd tracks (1, 3, 5 and 7), while the input signal from INPUT B is fed to even tracks (2, 4, 6 and 8).

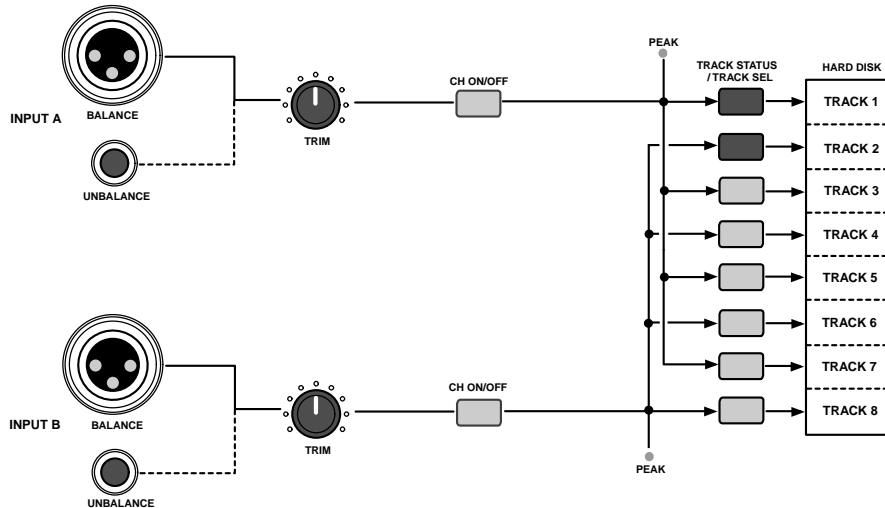

<Balanced (XLR) and unbalanced (phone) input connectors>

Both the balanced and unbalanced input connectors are provided for INPUT A and INPUT B, allowing connection of balanced and unbalanced devices. In addition, the phantom (DC 48 V) power can be supplied to the balanced XLR inputs, so you can use condenser microphones that need the phantom power (see the following section about how to use condenser microphones).

<Note>

You cannot use both the balanced and unbalanced inputs simultaneously.
When plugging the unbalanced (phone) input connector, the balanced (XLR) input connector is disconnected.

• How to use condenser microphones

When connecting a condenser microphone that needs the phantom power, set the [PHANTOM] switch on the rear panel to "ON". Read the following notes carefully before using the phantom power.

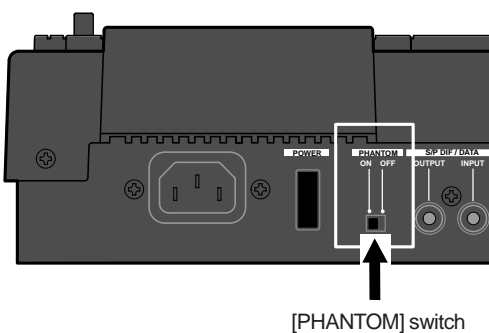

[PHANTOM] switch

<Notes for using the phantom power>

- Be sure to keep the following notes.
 - * When connecting a condenser microphone to the balanced input connector of the VF08, check whether or not the microphone needs the phantom power (+48 V).
 - * Switch the [PHANTOM] switch to ON after connecting a microphone.
 - * When switching the [PHANTOM] switch, or when plugging or unplugging a microphone, mute the VF08 output signals.
 - * When connecting a dynamic microphone to the balanced input connector, set the [PHANTOM] switch to OFF. Otherwise, the microphone may damage.
- You cannot use the phantom power for following microphones.
 - * microphones with the unbalanced output
 - * high impedance microphones
 - * microphones with the XLR connectors that leaks a signal between pin #2 and pin #1 or pin #3 and pin #1
 - * microphones with the center tapout type ground such as old-fashioned ribbon microphones

<Important notes for on/off switching>

Note that the VF08 power must be ON when changing the [PHANTOM] switch setting.
Also note that the [PHANTOM] switch should be set to "OFF" after using the phantom power.

Basic recording (recording onto a single track)

At first, let's record a single sound source onto a single track to know the basic recording procedure of the VF08. There are 8 recording tracks (Tracks 1 through 8) and you can record onto any desired track(s). In the following example, we are going to record an electric guitar (with an effect unit) onto Track 1. Before starting, set all the track faders (1 through 6 and 7-8) and the master fader to the lowest position ($-\infty$), and the [TRIM] knob to the leftmost position (LINE).

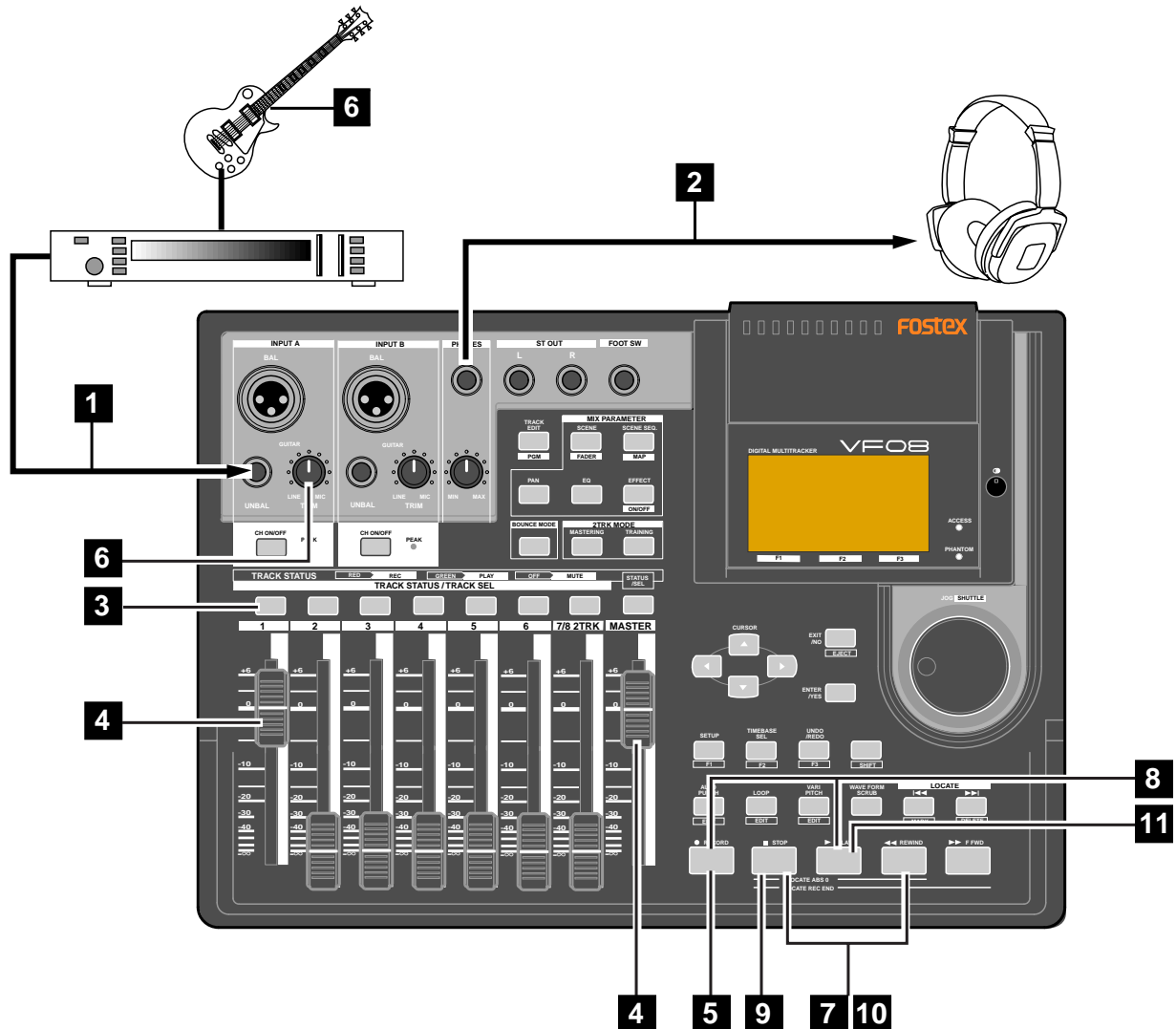

Preparation for recording

- 1 Connect the [INPUT A] UNBAL jack to the output of the effect unit whose input is connected to a guitar. To record onto Track 1, 3, 5 or 7, use INPUT A.
- 2 Connect the [PHONES] jack to headphones for monitoring.
- 3 Press the [TRACK STATUS/TRACK SEL] key of Track 1.
The key lighting in green changes to flashing in red, showing Track 1 is now armed. (The "Remain" time is shown on the screen.)
The [CH ON/OFF] key of INPUT A automatically lights. In this condition, by pressing the [CH ON/OFF] key of INPUT A, INPUT A can be muted.

- 4 Raise both the track 1 fader and master fader to "0" position.
This is preparation for monitoring sound. If both of these faders are set at the minimum position, no sound can be monitored.

<Note>

The track 1 fader can be used for adjusting the monitor level without affecting the recording level. To adjust the recording level, use the [TRIM] knob of INPUT A.

- 5 Press the [RECORD] key.
The key starts flashing in red, while Track 1 (which is armed) changes to the input monitor mode.

Basic Recording/Playback

- 6** Use the [TRIM] knob of INPUT A while playing the guitar to get proper gain.

Set the gain at maximum within the range in which the [PEAK] indicator does not turn on when playing the guitar at the loudest volume.

You can monitor both the input level of Track 1 and the stereo (L & R) output level from the bar-graph meters on the screen.

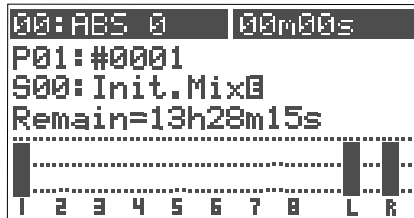

<Note>

Set the gain not to light the [PEAK] indicator when playing the guitar at the loudest volume. When the [PEAK] indicator lights, the input level is too high and the sound may be distorted or digital noise may be generated.

In the condition above, if you turn the [PHONES] knob clockwise, you can monitor the sound from the headphones.

<Warning!>

Be careful not to excessively raise the [PHONE] volume. Prolonged exposure to loud sounds may have an adverse effect on hearing.

Recording

- 7** Press the [REWIND] key while holding down the [STOP] key to locate "ABS 0".

If the current recorder position is "ABS 0", you can skip the operation above.

- 8** Press the [PLAY] key while holding down the [RECORD] key to start recording.

The [TRACK STATUS/TRACK SEL] key of Track 1 and the [RECORD] key light on, showing the VF08 is now recording.

The VF08 uses the direct recording method. In this method, a digital signal just after the A/D conversion is directly recorded onto a track, without being routed to extra algorithms such as EQ.

You can add reverb or equalize the sound during mixdown.

When the recorder starts running, the mark number and name shown on the top line of the screen changes as below, showing that the current position is ahead of "ABS 0" point.



- 9** To stop recording, press the [STOP] key. After showing "Please Wait!", the LCD returns to the Normal screen.

<Unarming a track>

To unarm a track, press the flashing [TRACK STATUS/TRACK SEL] key twice. The key changes to light in green.

Now you have recorded a sound source onto a track.

Playback

- 10** Press the [REWIND] key while holding down the [STOP] key to locate "ABS 0".

- 11** Press the [PLAY] key to start playback. You can control the playback level by the track 1 fader. If you find that the recording was not successfully made, use the undo/redo function and try recording again.

<Track muting >

The playback level of each recorded track can be controlled using the corresponding track fader. You can mute the playback track by pressing the corresponding [TRACK STATUS/TRACK SEL] key except in the mix parameter edit mode.

Undo/Redo

After finishing a recording, pressing the [UNDO/REDO] key returns to the condition just before recording (Undo).

If you press the [UNDO/REDO] key again, you can cancel the Undo operation and return back to the condition after recording.

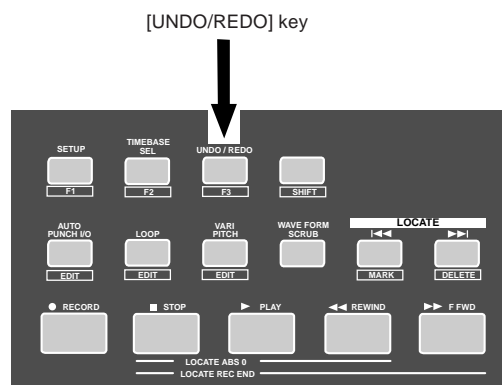

<Note>

The undo/redo function is available to any recording, however, if you carry out any of the following operations after recording, you cannot use the undo/redo function. Therefore, if you are not satisfied with the recording, press the [UNDO/REDO] key immediately to undo the recording and make recording again.

- * Making a new recording
- * Making a new editing (copy, move, erase, auto punch in/out, etc.)
- * Turning off the power
- * Executing program select, rename, and deleting
- * Executing drive selection

Basic recording (recording onto two tracks)

After recording onto track 1 as described in the previous section, let's make recording of a stereo sound source onto tracks 3 and 4.

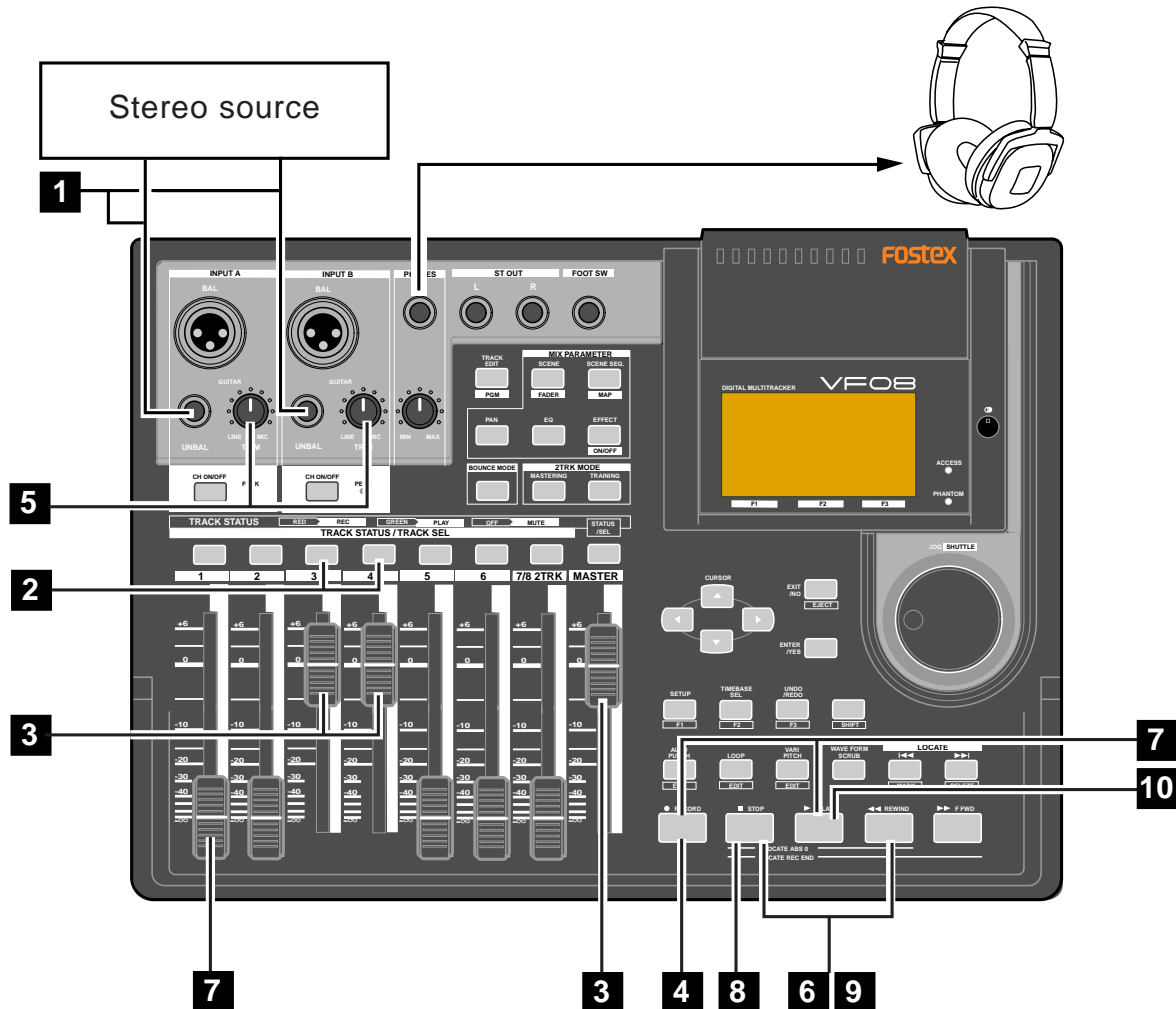

Preparation for recording

- 1 Connect the [INPUT A] UNBAL and [INPUT B] UNBAL jacks to the L and R outputs of the stereo source respectively.
- 2 Press the [TRACK STATUS/TRACK SEL] keys of Tracks 3 and 4.
The keys lighting in green change to flashing in red, showing Tracks 3 and 4 are now armed. (The "Remain" time is shown on the screen.)
The [CH ON/OFF] keys of INPUT A and B automatically light in green.
- 3 Raise the faders of tracks 3 and 4 and [MASTER] fader to "0" position.
This is preparation for monitoring sound. If both of these faders are set at the minimum position, no sound can be monitored.
- 4 Press the [RECORD] key.
The [RECORD] key starts flashing in red, while Tracks 3 and 4 (which are armed) changes to the input monitor mode.
- 5 Use the [TRIM] knobs of INPUT A and B while playing the stereo source to get proper gain.
Set the gain at maximum within the range in which the [PEAK] indicator does not turn on.
You can monitor both the input level of Tracks 3 and 4 from the bar-graph meters on the screen.

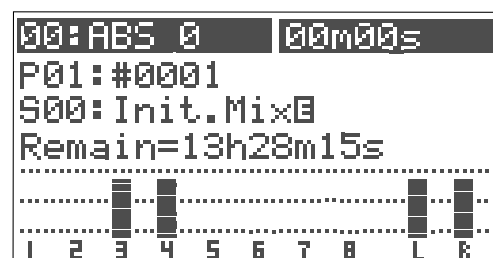

<Note>

Set the gain not to light the [PEAK] indicator. When the [PEAK] indicator lights, the input level is too high and the sound may be distorted or digital noise may be generated.

In the condition above, if you turn the [PHONES] knob clockwise, you can monitor the sound from the headphones.

<Warning!>

Be careful not to excessively raise the [PHONE] volume. Prolonged exposure to loud sounds may have an adverse effect on hearing.

Recording

- 6 Locate the start position (time) for recording.
- 7 Press the [PLAY] key while holding down the [RECORD] key to start recording. The [TRACK STATUS/TRACK SEL] keys of Tracks 3 and 4, as well as the [RECORD] key light on, showing the VF08 is now recording.

You can see the meter for Track 1 also moving. By raising the Track 1 fader, you can make overdubbing onto tracks 3 and 4 while listening to playback of track 1.

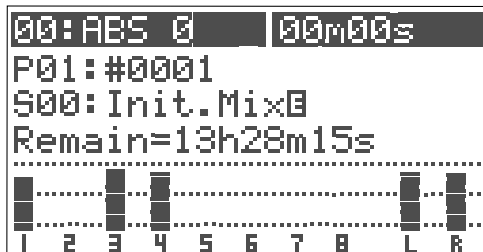

When the recorder starts running, the mark number and name shown on the top line of the screen changes as below, showing that the current position is ahead of "ABS 0" point.



- 8 To stop recording, press the [STOP] key. After showing "Please Wait!", the LCD returns to the Normal screen.

<Unarming tracks>

To unarm tracks now recorded, press the flashing [TRACK STATUS/TRACK SEL] keys again. The keys changes to light in green.

Playback

- 9 Locate the desired position (time) for playback.
- 10 Press the [PLAY] key to start playback. You can control track playback levels by using the corresponding track faders.

If you find that the recording was not successfully made, use the undo/redo function and try recording again.

<Track muting>

The playback level of each recorded track can be controlled using the corresponding track fader. You can mute the playback tracks by pressing the corresponding [TRACK STATUS/TRACK SEL] keys except in the mix parameter edit mode.

<How to use recording tracks effectively>

The VF08 has 8 recordable tracks. If you record materials onto all 8 tracks according to the procedures described in "Basic recording", you cannot record further materials. To record more materials, you can use the "track bounce" technique to save tracks as follows:

1. Record materials onto tracks 1 through 6.
2. Mix the signals recorded on tracks 1 through 6 and record the mixed signal onto tracks 7 and 8.

Then tracks 1 through 6 can be used to record other materials.

This is the basic technique used for Multitrackers. We recommend that tracks 7 and 8 are basically used as the destination tracks of "track bounce" from tracks 1 through 6.

See "Advanced Operation" for details about the track bounce technique.

In addition, tracks 7 and 8 play an important role in "training mode" and "mastering mode" described later in "Advanced functions".

The VF08 also provides the "track exchange" function which allows you to keep recordable tracks. The VF08 has 16 additional tracks for each program, in addition to 8 recordable (and playable) real tracks (1 through 8). The "track exchange" function allows you to exchange a real track and an additional track, making the real track empty.

See page 51 "Recorder functions."

Now you have recorded a stereo source onto two tracks (3 and 4).

Mark function

The VF08 has the Mark function which allows you to set marks at the desired positions in a song. You can locate a mark position immediately, as well as use mark positions for the punch in and out points, beginning and end points for repeat and editing points for track editing such as copy, move, erase, etc. This section describes how to set, delete and locate a mark. For details about editing a mark, see “Recorder functions” described later.

Setting a mark on the fly

In the initial condition, Mark 00 is automatically entered at the beginning of the current program (ABS 0) and named “ABS 0”. You can enter up to 99 marks (Mark 01 through 99). Mark number and name are shown on the Normal screen as the arrow points in the screen example below. (You cannot edit or delete Mark 00.)



- 1 During playback (or while stopped), press [\llcorner / MARK] key while holding down the [SHIFT] key. “Entry Mark” is shown briefly and a mark is entered at the current position. Also the time marked is entered in the mark map list (see “Recorder functions” for details).

- 2 To enter another mark, repeat step 1) above.

<Note>

Marks are assigned in ascending order of ABS time. For example, even if you enter marks in order as shown in the upper diagram below, the mark numbers are assigned as shown in the lower diagram.

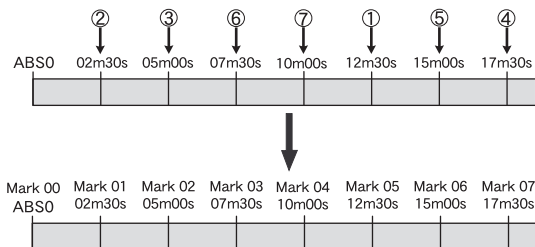

Locating a mark

You can locate a mark using the [\llcorner] or [\gg] key.

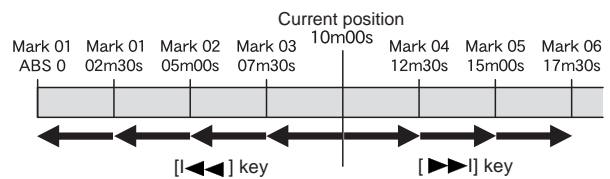

- Pressing [\llcorner] key locates the previous mark. In the example above, each time you press the key from the current position, the recorder will locate Mark 03 -> 02 -> 01 -> 00.
- Pressing [\gg] key locates the next mark. In the example above, each time you press the key from the current position, the recorder will locate Mark 04 -> 05 -> 06.

The current (located) mark number is shown on the Normal screen.



Deleting a mark

You can delete unnecessary mark

- 1 While stopped, locate the mark to be deleted using the [\llcorner] or [\gg] key. The mark to be deleted is shown on the screen.
- 2 Press the [\gg]/[DELETE] key while holding down the [SHIFT] key. A pop-up panel asking for confirmation to delete the current mark appears, in which “Sure?” blinks. To cancel the operation for deletion, press the [EXIT/NO] key.
- 3 Press the [ENTER/YES] key while holding down the [RECORD] key. The current mark is deleted.

ABS locate functions

There are four types of the ABS locate functions as below.

- Pressing the [REWIND] key while holding down the [STOP] key locates the beginning of the current program (ABS 00), regardless of the time base setting.
- Pressing the [F FWD] key while holding down the [STOP] key locates the end position of the last recording of the current program (REC END).
You can use this function to locate the end point of a song or to check the length of a song.
- Pressing the [PLAY] key while holding down the [STOP] key locates the beginning of the last playback.
- Pressing the [RECORD] key while holding down the [STOP] key locates the beginning of the last recording.

Punch in/out

If you are not satisfied with your recording and want to modify only a specific part, you can replace the part with a new recording using the punch in/out technique.

“Punch in” switches the transport mode from playback to recording, while “Punch out” switches the transport mode from recording to playback. The point at which a punch in is carried out is called a “punch in point”, while the point at which a punch out is carried out is called a “punch out point.”

You can carry out the punch in/out operation in 3 ways:

- * Manual punch in/out using the keys on the unit
- * Using the foot switch (Model 8051)
- * Auto punch in/out function
After setting the punch in and out points, the punch in/out can be took place automatically.

The following description is assumed that the track(s) to be punched in/out are armed and the source input level is set appropriately by using the [TRIM] knob.

Manual punch in/out using the keys on the unit

- 1 Start playback by pressing the [PLAY] key from a position before the punch in point.
- 2 When the playback position reaches the punch in point, press the [RECORD] key while holding down the [PLAY] key.
Only the armed track(s) switch from playback to recording.
- 3 At the punch out point, press the [PLAY] key .
The armed track(s) switch from recording to playback.

Punch in/out using the foot switch

- 1 Connect the Model 8051 foot switch to the [FOOT SW] jack.

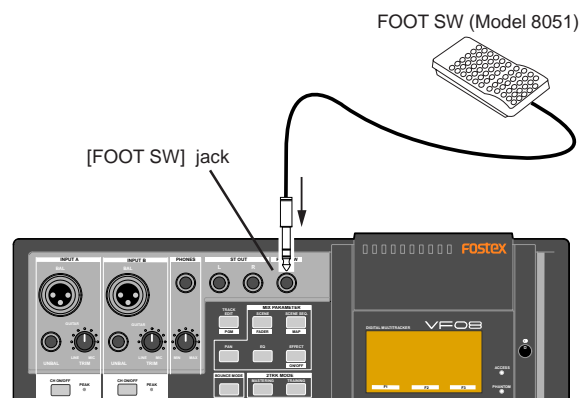

- 2 Start playback by pressing the [PLAY] key from a position before the punch in point.
- 3 When the playback position reaches the punch in point, step on the foot switch.
Only the armed track(s) switch from playback to recording.
- 4 At the punch out point, step on the foot switch.
The armed track(s) switch from recording to playback.

Auto punch in/out function

You must set the punch in and out points before performing auto punch in/out recording. You can set the points either during playback and while stopped. In the following description, we assume that the “ABS” time base is selected.

• Setting the punch in/out points on the fly during playback (or while stopped)

- 1 Press the [AUTO PUNCH/EDIT] key while holding down the [SHIFT] key. The screen for setting the punch in/out points appears.

During playback, this counter shows the current recorder position in real time.

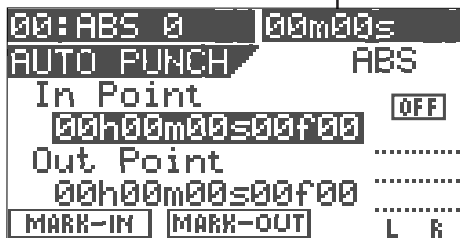

- 2 At the point at which you want to set the punch in point, press the [SETUP/F1] key while holding down the [SHIFT] key. “In Point Stored!” appears briefly, and the point is stored as the punch in point.

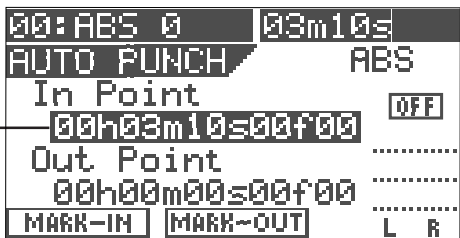

The time (or bar/beat) stored is shown here.

- 3 At the point at which you want to set the punch out point, press the [TIME BASE SEL/F2] key while holding down the [SHIFT] key. “Out Point Stored!” appears briefly, and the point at which you carry out the operation above is stored as the punch out point.

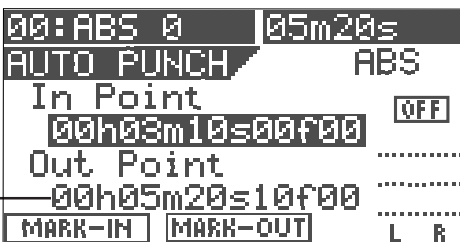

The time (or bar/beat) stored is shown here.

<Note>

Set the punch in point earlier than the punch out point.

• Setting the punch in/out points numerically

While the recorder is stopped, you can set the in and out points by entering the time numerically.

- 1 While stopped, press the [AUTO PUNCH/EDIT] key while holding down the [SHIFT] key. The screen for setting the punch in/out points appears.

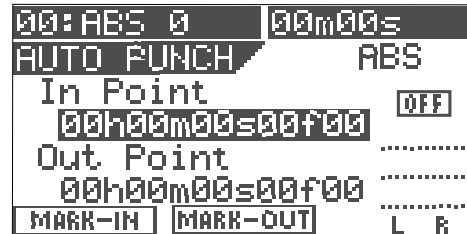

- 2 Press the [ENTER/YES] key while the punch in point value is highlighted on the screen as above. Now you can edit the punch in point value. Initially, the “seconds” value starts blinking, showing that it can be edited.

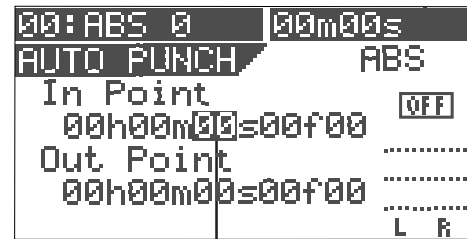

Flashing

- 3 Move the blinking value by using the [CURSOR </>] key and enter the desired value using the [JOG] dial.
- 4 After completing editing the time value, press the [ENTER/YES] key. The edited time is stored as the punch in point.
- 5 Use the [CURSOR down] key to highlight the punch out point value, and press the [ENTER/YES] key. Now you can edit the punch out point value.

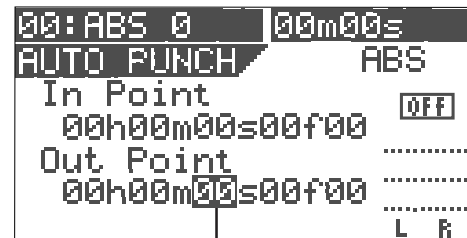

Flashing

- 6 Enter the desired value with the same method as entering the punch in point, then press the [ENTER/YES] key. The edited time is stored as the punch out point.
- 7 After storing times for both points, press the [EXIT/NO] key. The LCD returns to the Normal screen.

- Taking a mark point in the punch in or punch out point
You can take a mark point in the punch in or out point.

<Note>

The following operation is possible only when any marks are stored using the Mark function described earlier.

- 1 Press the [AUTO PUNCH/EDIT] key while holding down the [SHIFT] key.
The screen for setting the punch in/out points appears.

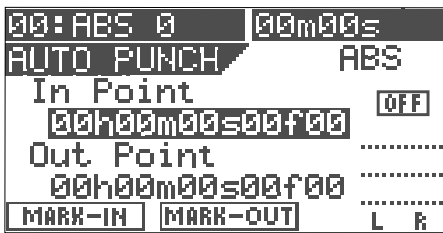

- 2 Press the [TIME BASE SEL] key when the in point time value is highlighted (as above).
The highlighted line changes to show a mark.

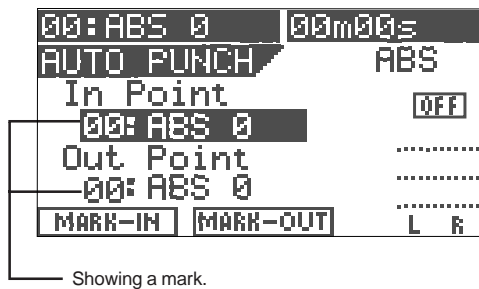

- 3 Press the [ENTER/YES] key.
The highlighted mark starts blinking.

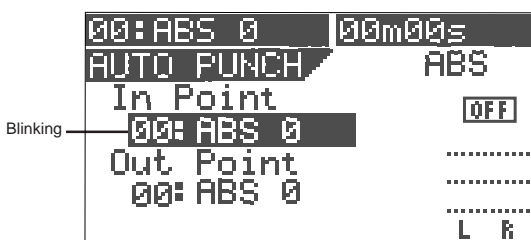

- 4 Use the [JOG] dial to select the desired mark, and then press the [ENTER/YES] key.
The selected mark position is taken in the punch in point.
- 5 Use the [CURSOR down] key to highlight the punch out point value, and press the [ENTER/YES] key.
- 6 Use the [JOG] dial to select the desired mark, and then press the [ENTER/YES] key.
The selected mark position is taken in the punch out point.
- 7 After setting both points, press the [EXIT/NO] key.

- Performing auto punch in/out recording
After storing the punch in and out points, you can perform the auto punch in/out recording.

- 1 Press the [AUTO PUNCH /EDIT] key (to illuminate the key).
The auto punch mode is now active.
- 2 Locate the earlier position to the punch in point.
- 3 Press the [RECORD] key while holding down the [PLAY] key.
A “take” of auto punch in/out recording starts and “TAKE” lights up on the screen.

The recorder starts playback, and then automatically puts into the record mode at the punch in point. It automatically switches to playback at the punch out point.

<Rehearsal>

In the step 3) above, if you press only the [PLAY] key, a “rehearsal” of auto punch in/out recording starts and “RHSL” lights up on the screen. In the rehearsal mode, when the recorder reaches the punch in point, only the monitor of the armed track(s) switches to “Input monitor” without performing actual recording. You can rehearse as many times as you like before actual recording.

Hint:

If you use the loop function together with the rehearsal mode, you can rehearse your playing repeatedly without the need of the recorder operation, allowing you to concentrate on your playing. See “Recorder functions” for details about the loop function.

Mixing

After recording all tracks (1 through 8), you can tailor the sound of each track. The following describes about settings for level, pan, EQ and effects.

Adjusting levels

- Adjust the playback level of each track using the corresponding fader (1 through 6 and 7/8).
The levels of tracks 7 and 8 are simultaneously controlled by a single fader (7/8).
- Adjust the stereo master output (ST OUT L/R) levels using the [MASTER] fader.

<About master output levels>

You can view the stereo master output (L/R) levels from the L/R level meters on the screen. The output levels are affected by the [MASTER] fader position. Be sure not to set the fader level too high to avoid the sound distorted.

Setting pan position

You can set the pan position of each track.

- Press the [PAN] key.
The pan setting screen is shown, where “Select TRK!” is blinking in the initial condition.

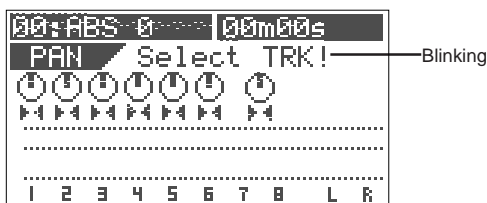
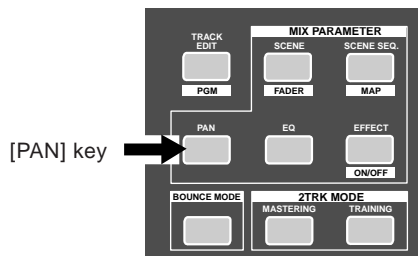

- Press the [TRACK STATUS/TRACK SEL] key of the desired track (or use the [CURSOR </>] keys to select the desired track).
The pan icon of the selected track is highlighted, showing that it is editable.

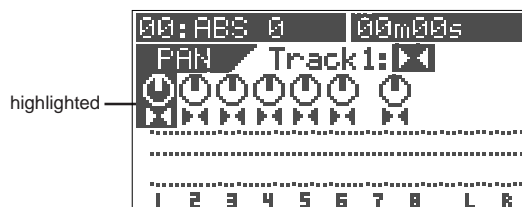

- Set the pan position using the [JOG] dial.
The pan icon on the screen changes in real time according to the rotation of the [JOG] dial.
- Repeat steps 2) and 3) to set other tracks.
- After completing the pan setting, press the [EXIT/NO] key.
The LCD returns to the Normal screen.

Adjusting EQ

- Press the [EQ] key.
The EQ screen is shown, where “Select TRK!” is blinking in the initial condition.

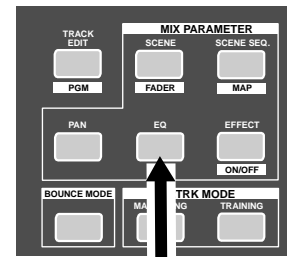

[EQ] key

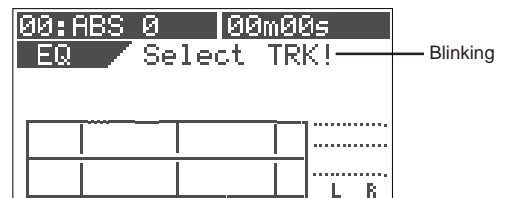

- Press the [TRACK STATUS/TRACK SEL] key of the desired track.
The default preset library entry (“L00: 2-SHLV”) is shown, in which the High Gain field is highlighted, showing that it can be edited.

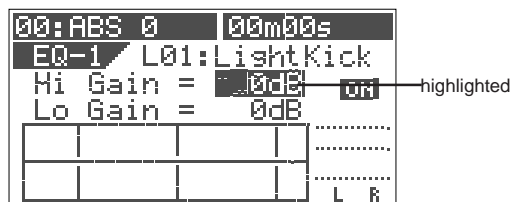

<Selecting from the EQ library>

There are 36 presets besides the default preset in the EQ library. You can select a desired preset according to the situation and tailor the sound. See “Mixer functions” for details.

- Edit the “Hi Gain” value using the [JOG] dial.
The EQ curve is shown according to the value setting, while the sound changes in real time.
You can set the value between -18 dB and + 18 dB.

- 4 Highlight the “Lo Gain” field by using the [CURSOR down] key, and edit the “Lo Gain” value using the [JOG] dial.
You can set the value between -18 dB and + 18 dB, as same as the Hi Gain.
- 5 Repeat steps 2 through 4 to edit EQ on other tracks.
- 6 After completing the EQ setting, press the [EXIT/NO] key.
The LCD returns to the Normal screen.

Setting effects

This section describes how to set the effect send levels and how to select the effect type.

You can also perform pre/post setting, effect parameter setting, etc. See “Mixer Functions” described later for details.

- 1 Press the [EFFECT] key.
The effect send level setting screen appears initially. Each press of the [EFFECT] key switches between the effect send level setting screen, effect type selection screen and effect send pre/post selection screen.

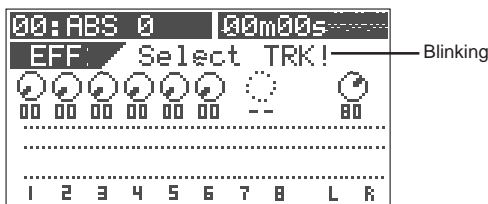
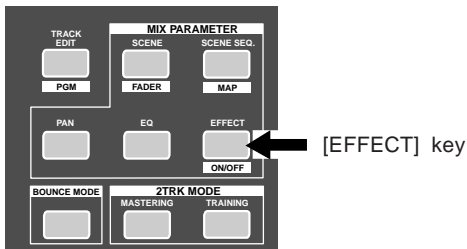

Effect send level setting

- 2 While the effect send level setting screen is shown, press the [TRACK STATUS/TRACK SEL] key of the desired track.
The effect knob icon of the selected track is highlighted, showing that it can be edited.
The default value for track sends 1 through 6 is “0” while the default value for the master is “80”.

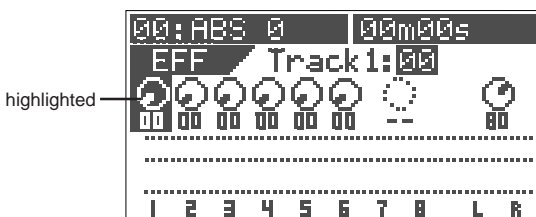

- 3 Use the [JOG] dial to enter the send level.
While the send level changes, the corresponding icon also changes in real time.
When the value increases, the effect sound of the currently selected effect type will be output.
- 4 To set the effect send levels for other tracks, carry out step 2 and 3 above repeatedly.

Effect type setting

<Effect type setting>

The VF08 provides 38 effect types in the effect library. You can select any one of the types depending on the usage. See “Mixer functions” for details about the effect library.

- 2 Bring up the effect type setting screen and select the desired effect type by rotating the [JOG] dial.
While rotating the [JOG] dial, the effect type appears one after the other among 38 types.

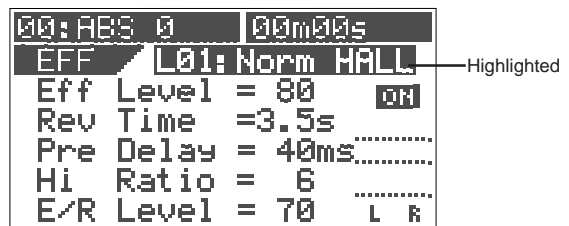

- 3 After selecting the desired effect type, press the [ENTER/YES] key.
The selected effect type is set.
- 4 Press the [EFFECT] key to bring up the effect send level setting screen.
- 5 Adjust the effect send levels as described above.

<Pre/post setting of effect sends>

All the effect sends from tracks 1 through 6 are initially set to “post-fader”. Therefore, when a track fader is completely down, no signal is sent even if you raise the effect send level of the track. You can also select “pre-fader” if necessary. See “Mixer functions” for details.

<Parameter setting for each effect type>

You can set parameters for the selected effect type. See “Mixer functions” for details about parameter setting.

<On/Off setting of the effect>

You can switch on or off the effect alternately by pressing the [EFFECT/ON/OFF] key while holding down the [SHIFT] key. See “Mixer functions” for details.

Mixdown

After tailoring sound of all the tracks, let's make a master tape (disc) using your master recorder (cassette, DAT, MD, etc.). As the VF08 can feed the stereo outputs (L and R) via the S/PDIF (coaxial) digital output jack, you can make the master tape (disc) in digital domain if your recorder provides a digital input jack. If your digital recorder only provides the optical input jack, use the Fostex COP-1 optical to coaxial converter.

<Using the mastering mode:>

The VF08 provides the mastering mode. Using this mode, you can create a powerful master by recording the mixed-down signal on Tracks 7/8 onto an external master recorder while applying the dedicated mastering effects to the signal. See "Advanced Operation" for details about the mastering mode.

Analog mixdown

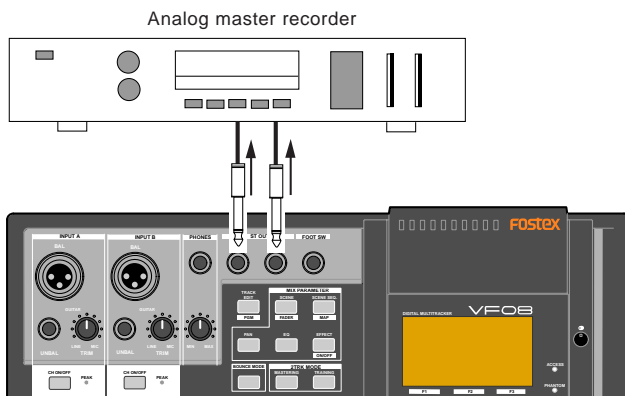

- 1 Connect the [ST OUT - L/R] jacks to the input jacks of your analog master recorder.
- 2 Set the recording level of the master recorder.
- 3 Start recording the master recorder, and start playback of the VF08 from the beginning of the song.
- 4 When recording finishes, stop both the units.

<Fade in/out:>

You can fade in or fade out a song by using the [MASTER] fader.

Digital mixdown

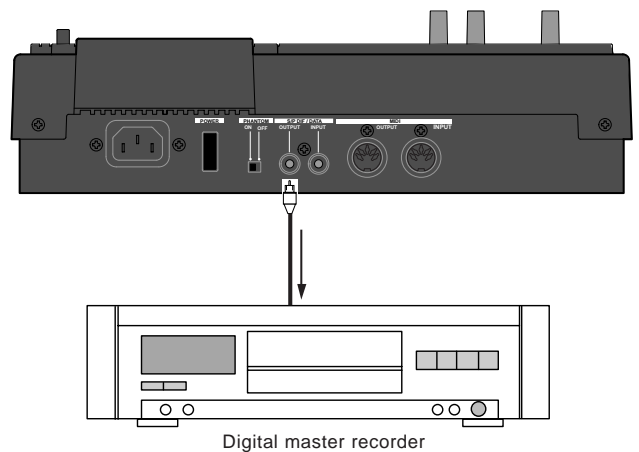

- 1 Connect the [DATA OUTPUT] jack to the digital input jack of your master recorder.
- 2 Set the master recorder's recording source to the digital input.
 - The sampling frequency of the VF08 is fixed to 44.1 kHz, so you cannot record the VF08 digital output signal to the master recorder that cannot accept 44.1 kHz digital signals.
 - In general, you cannot adjust the digital input level of a digital recorder.
- 3 Adjust the stereo output level of the VF08 using the [MASTER] fader.
 - In general, set the fader so that the level meter on the master recorder indicates "0" when the VF08 feeds the loudest level signal. If the level is too high, the sound may be distorted.
- 4 Start recording the master recorder, and start playback of the VF08 from the beginning of the song.
- 5 When recording finishes, stop both the units.

Mixer Functions

Initial condition when turning on the power

When turning on the power, the VF08 starts up while showing the unit information on the LCD display and then gets ready when the screen below appears. This screen is called "Normal Screen", in which the program number and current recorder position are shown. In the following example (the default), Program 1 (P01) is loaded and the current position is the beginning (ABS 00M 00S).

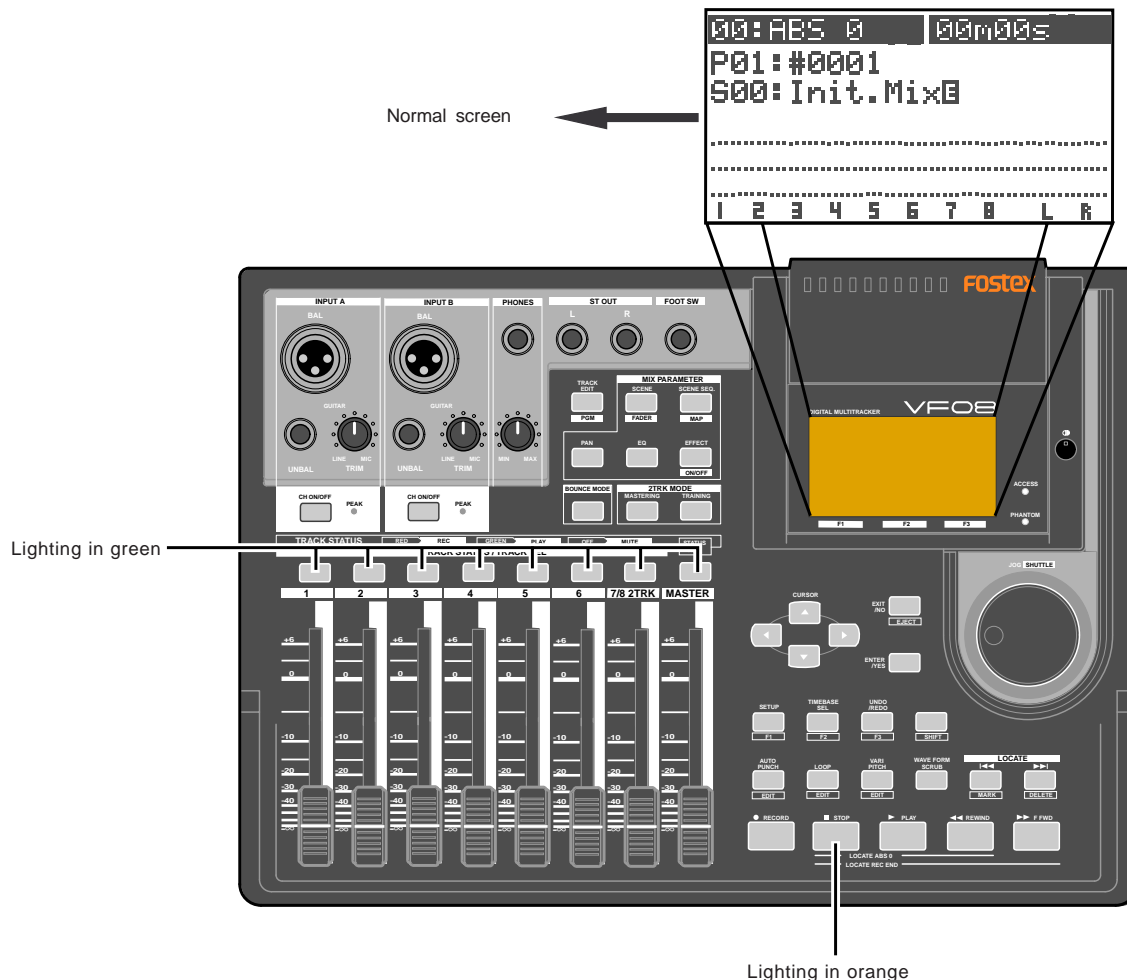

Operations while the Normal screen is shown

Fader

The fader for each track (1 through 6 and 7/8) controls the level of the playback signal fed to the stereo outputs.

Track mute

While the VF08 is not in the mix parameter edit mode, pressing any one of the [TRACK STATUS/TRACK SEL] keys (for tracks 1 through 6 and 7/8) mutes the corresponding track.

The [TRACK STATUS/TRACK SEL] key for the muted track is unlit. Pressing the key again releases muting and lights up the key.

Master fader mute

While the VF08 is not in the mix parameter edit mode, pressing the [STATUS/SEL] key for the master fader mutes the stereo outputs. While the stereo outputs are muted, the [STATUS/SEL] key is unlit. Pressing the key again releases muting and lights up the key.

Mix parameter section

The Mix parameter section provides five keys that are used for mixer function settings. By pressing one of these keys alone or while holding down the [SHIFT] key, you can execute the following.

- Pan setting
- EQ setting
- Effect send level setting
- Effect send pre/post setting
- Effect type/parameter setting
- Effect on/off setting
- Save/load/delete of a scene memory
- Scene sequence mode on/off setting
- Mark map setting
- Fader view

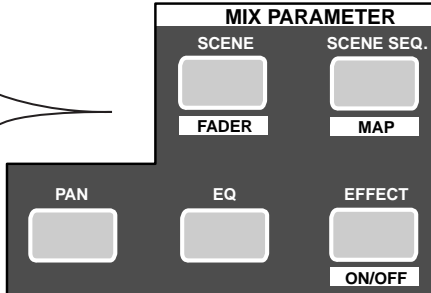

Adjusting pan positions

You can adjust the pan position of each track signal fed to the stereo outputs.

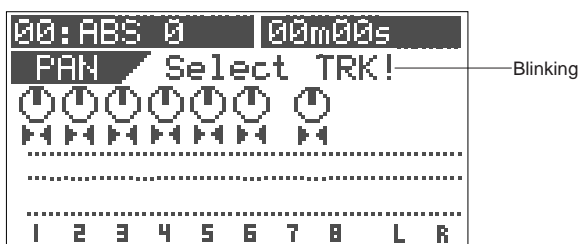

- Press the [PAN] key.
The pan screen appears.
If you have not edited any track parameter for pan, EQ or effect send setting after turning on the power last time, the message prompting to select a track ("Select TRK!") blinks, as well as all the [TRACK STATUS/TRACK SEL] keys on the panel flash.
If you have edited any track parameter for pan, EQ or effect send setting after turning on the power last time, the icon for the previously edited track is highlighted, showing that it can be edited.



- Select the desired track by pressing the corresponding [TRACK STATUS/TRACK SEL] key (or using the [CURSOR </>] keys).
The pan icon of the selected track is highlighted, indicating that you can edit it.
The [TRACK STATUS/TRACK SEL] key of the selected track flashes.



- Use the [JOG] dial to adjust the pan position.
The pan position is set according to the rotating degree.
The following show examples of the pan settings.

		
Pan position: center	Pan position: hard left	Pan position: hard right
<ul style="list-style-type: none"> •Controllable tracks Tracks 1 through 6 and 7/8 •Available values L10 (hard left) through C (center) to R10 (hard right) (the default setting: "C" for all tracks) 		

- To adjust the pan position for another track, repeat steps 2 and 3 above.
- After completing pan setting, press the [EXIT/NO] key.
The VF08 exits the mix parameter edit mode and the LCD display returns to the Normal screen.

Editing EQ

The VF08 is equipped with 2-band (HI and LO) EQ for Tracks 1 through 6. 36 preset entries are available in the EQ library.

<Note>

You can apply EQ only to Tracks 1 through 6. You cannot apply EQ to Tracks 7/8.

- Press the [EQ] key. The EQ screen appears. If you have not edited any track parameter for EQ, pan or effect send setting after turning on the power last time, the message prompting to select a track ("Select TRK!") blinks, as well as the [TRACK STATUS/TRACK SEL] keys for Tracks 1 through 6 on the panel flash. If you have edited any track parameter for pan, EQ or effect send setting after turning on the power last time, the icon for the previously edited track is highlighted, showing that it can be edited.

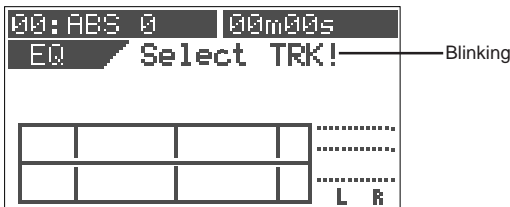

- Select the desired track by pressing the corresponding [TRACK STATUS/TRACK SEL] key (or using the [CURSOR </>] keys). The selected track number and library entry name (shown as "EQ-1" and "L00:2-SHLV" respectively in the screen example below) are shown, together with the current settings. The gain value of Hi EQ ("Hi Gain") blinks, indicating that you can edit it.

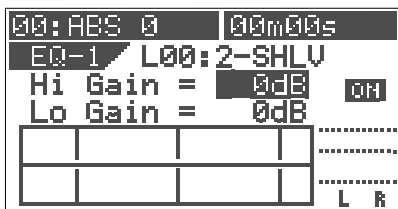

- Use the [CURSOR up/down] key to select a parameter to be edited. Each time you press the [CURSOR/down] key, the blinking parameter (to be edited) changes in the following order: Hi Gain -> Lo Gain -> EQ ON/OFF -> library entry -> Hi Gain... Pressing the [CURSOR/up] key changes the blinking parameter in the reverse order.

- Use the [JOG] dial to edit the parameter value. The following values are available for each parameter.

Hi Gain	-18 dB through 0 dB to +18 dB in 1 dB steps. The current EQ curve is shown graphically according to the current values.
Lo Gain	-18 dB through 0 dB to +18 dB in 1 dB steps. The current EQ curve is shown graphically according to the current values.
ON/OFF	ON or OFF of EQ

Library	Selectable from 36 preset library entries (L00 through L36). The default is "L00: 2-SHLV". After selecting the desired library, press the [ENTER/YES] key to confirm the setting. *See the following table for details about the EQ library.
---------	---

Setting example 1: Set "Hi Gain" to "+11 dB." The high frequency gain is boosted up as shown graphically.

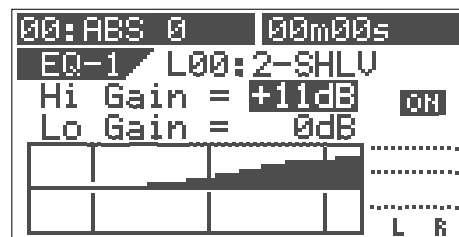

Setting example 2: Set "Lo Gain" to "-8 dB." The low frequency gain is cut as shown graphically.

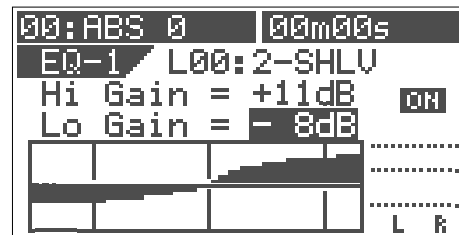

Setting example 3: Set "EQ library" to "L03." The high frequency gain is boosted up as shown graphically.

By using the [JOG] dial to select "L03": Ana.Kick and pressing the [ENTER/YES] key, the preset parameter values are shown together with the corresponding EQ curve.

You can edit parameters from this preset condition and store the setting as a scene. Note that if you turn off the power, the setting is cleared.

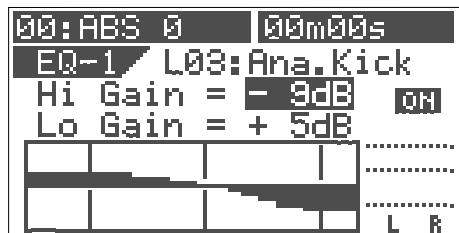

- To edit the EQ for another track, repeat steps 2 through 4.
- After completing EQ editing, press the [EXIT/NO] key. The VF08 exits the EQ edit mode and the LCD display returns to the Normal screen.

Preset entries in the EQ library

L00: 2-SHLV		LO	HI
Flat setting The first time you bring up the EQ screen, this entry is selected.	Gain	0	0
	Freq.	400Hz	4kHz
	Q	L-S	H-S
L01: LightKick		LO	HI
Creates a light and jaunty kick sound	Gain	+6.0	-12.0
	Freq.	400Hz	600Hz
	Q	L-S	5.0
L02: TightKick		LO	HI
Creates a tight and hard kick sound.	Gain	+7.0	+10.0
	Freq.	400Hz	4kHz
	Q	L-S	8.0
L03: Ana.Kick		LO	HI
Makes an analog kick sound boomy.	Gain	+5.0	-9.0
	Freq.	550Hz	6kHz
	Q	L-S	H-S
L04: Snappy_SD		LO	HI
Makes a snare sound snappier.	Gain	-7.0	+6.0
	Freq.	1kHz	3.5kHz
	Q	L-S	2.5
L05: Power_SD		LO	HI
Creates a powerful and heavy snare sound.	Gain	+8.0	+5.0
	Freq.	150Hz	3.5kHz
	Q	4.5	2.5
L06: Deep_SD		LO	HI
Creates a heavy sound of a snare drum with a deep body.	Gain	+3.0	+4.0
	Freq.	550Hz	4.3kHz
	Q	4.5	2.2
L07: Talk_Tom		LO	HI
Creates a skinny tom-tom sound.	Gain	+4.0	+7.0
	Freq.	100Hz	3.2kHz
	Q	7.1	6.3
L08: Melo.Tom		LO	HI
Creates a melodious sound.	Gain	+6.0	-12.0
	Freq.	100Hz	1.7kHz
	Q	2.8	2.2
L09: W.GongTom		LO	HI
Makes a tom-tom sound woody.	Gain	-10.0	+17.0
	Freq.	130Hz	520Hz
	Q	L-S	7.1

L10: Lo-Fi_Cym		LO	HI
Removes the brightness from a cymbal sound by cutting high frequencies.	Gain	+3.0	-18.0
	Freq.	300Hz	8kHz
	Q	1.6	H-S
L11: Perc.		LO	HI
Creates a bright sound by emphasizing the attack of a conga, bongo, etc.	Gain	-4.0	+7.0
	Freq.	100Hz	6kHz
	Q	L-S	H-S
L12: Tamb.		LO	HI
Creates a subtle sound by emphasizing the presence of a tambourine, etc.	Gain	-8.0	+10.0
	Freq.	360Hz	5.4kHz
	Q	L-S	H-S
L13: Fat_Bass		LO	HI
Creates a fat base sound by slightly boosting the low frequency range.	Gain	+5.0	+3.0
	Freq.	100Hz	2.4kHz
	Q	0.1	6.3
L14: Norm.Bass		LO	HI
Creates a all-round bass sound.	Gain	+5.0	+4.0
	Freq.	190Hz	2.4kHz
	Q	1.0	1.0
L15: Loud_Bass		LO	HI
Creates a good analog bass sound by boosting the low frequency range and emphasizing the attack.	Gain	+4.0	+3.0
	Freq.	120Hz	1.3kHz
	Q	2.0	2.2
L16: Bright_Pf		LO	HI
Creates a bright piano sound.	Gain	-3.0	+4.0
	Freq.	340Hz	5kHz
	Q	0.9	H-S
L17: Loud_Pf		LO	HI
Creates a rich piano sound by boosting the low frequency range which contains rich harmonics.	Gain	+5.0	-3.0
	Freq.	200Hz	1.3kHz
	Q	L-S	0.9
L18: Power_Pf		LO	HI
Creates a tight and smooth sound. Suitable for a piano solo.	Gain	-13.0	+7.0
	Freq.	170Hz	5.4kHz
	Q	0.7	1.1
L19: E.Pf		LO	HI
Creates a sound which emphasizes the attack and distortion when hitting keyboards of an electric piano.	Gain	+8.0	+3.0
	Freq.	1kHz	6.4kHz
	Q	0.7	1.7

Mixer Functions

L20: Clean_EG

Adds a bright character to a transparent and clean electric guitar sound.

	LO	HI
Gain	-4.0	+4.0
Freq.	100Hz	6.6kHz
Q	L-S	H-S

L21: CrunCh_EG

Makes a moderately distorted crunch electric guitar sound distinctive.

	LO	HI
Gain	-2.0	+6.0
Freq.	120Hz	4kHz
Q	0.7	1.4

L22: OverDrvEG

Makes a mellow overdriven electric guitar sound fatter.

	LO	HI
Gain	+6.0	+7.0
Freq.	310Hz	1.3kHz
Q	1.5	1.1

L23: Dist.EG

Makes a hardly distorted electric guitar sound distinctive.

	LO	HI
Gain	+6.0	+4.0
Freq.	370Hz	3.6kHz
Q	L-S	10

L24: Metal_EG

Makes a high-gain metal sound distinctive.

	LO	HI
Gain	+3.0	+12.0
Freq.	230Hz	14kHz
Q	0.7	H-S

L25: Stroke_AG

Suppresses a hole resonance of an acoustic guitar and makes a code stroke sound powerful.

	LO	HI
Gain	-9.0	+8.0
Freq.	100Hz	9kHz
Q	0.7	1.2

L26: Arpeg.EAG

Controls the arpeggio code balance of an electro-acoustic guitar.

	LO	HI
Gain	-2.0	+3.0
Freq.	210Hz	9.4kHz
Q	L-S	0.1

L27: Arpeg.AG

Suppresses a hole resonance of an acoustic guitar and makes an arpeggio brighter.

	LO	HI
Gain	-7.0	+5.0
Freq.	530Hz	4.4kHz
Q	7.1	H-S

L28: Brass_Sec

Controls the balance of brass instruments (such as trumpets, trombones. etc.).

	LO	HI
Gain	-3.0	+4.0
Freq.	100Hz	5.6kHz
Q	2.5	5.0

L29: W.WindSec

Makes the mid frequency range of woodwind instruments (such as clarinets, oboe, etc.) richer.

	LO	HI
Gain	+3.0	+4.0
Freq.	125Hz	260Hz
Q	L-S	2.2

L30: Male_Vo

Effective for a male vocal

	LO	HI
Gain	+2.0	+3.0
Freq.	2kHz	6.2kHz
Q	0.5	H-S

L31: Female_Vo

Effective for a female vocal

	LO	HI
Gain	-5.0	+4.0
Freq.	170Hz	5.8kHz
Q	0.7	H-S

L32: Chorus

Effective for a whole chorus part by emphasizing the high frequency range.

	LO	HI
Gain	-5.0	+5.0
Freq.	120Hz	10kHz
Q	0.7	H-S

L33: SpeeCh

Makes a narration clear.

	LO	HI
Gain	ON	+3.0
Freq.	180Hz	10kHz
Q	HPF	H-S

L34: Digi.Mix

Makes an analog open-reel or cassette tape sound closer to a digital sound.

	LO	HI
Gain	+5.0	+6.0
Freq.	100Hz	12kHz
Q	L-S	H-S

L35: AnalogMix

Cuts the high frequency range and provides an opposite character to L34.

	LO	HI
Gain	ON	ON
Freq.	250Hz	8kHz
Q	HPF	LPF

L36: Telephone

Emphasizes the mid range only to provide a telephone receiver sound.

	LO	HI
Gain	ON	ON
Freq.	1.2kHz	5.6kHz
Q	HPF	LPF

Editing Effects

This section describes how to use the internal DSP multi-effect processor.

The DSP multi-effect processor incorporates 38 types of digital effects and you can edit parameters for each effect type.

To understand various effect functions, we recommend to operate the unit while hearing how the actual effect sound changes.

The DSP multi-effect processor built in the VF08 uses the Fostex A.S.P. (Advanced Signal Processing) technology and provides the high-performance ambience effect that is comparable to professional reverb units.

<Note>

The effect edit operations described here are only available to Tracks 1 through 6.

On Track 7/8, a dedicated "Mastering effects" is built in and you can edit the effects while carrying out the mastering mode. See "Chapter 5 Advanced Functions" for details.

Before describing the VF08 effect edit mode, we briefly explain the effect functions (reverb, delay, chorus and flanger).

Reverb:

The so called Reverb effect consists of various reflection sounds mixed together. For example, when you clap your hands in a tunnel, you will hear the sound linger even after you stop clapping your hands. This is the Reverb.

The sounds we normally hear in daily life have three types of sounds mixed together, i.e., "Direct sound," "Early Reflection sound" and "Late Reflection sound."

The Direct sound means the sound directly reaches the ears from the sound source. The Early Reflection sound means the sound that comes after the Direct sound and has rebound off the wall of the tunnel up to a few times. The Late Reflection sound means that the sound rebounds many times long after the Direct sound has disappeared. Our ears normally hear the "Direct sound" - "Early Reflection sound" - "Late Reflection sound" in the order.

Delay:

This is the effect to added a delayed sound to the original sound. You can obtain a richer sound or completely change the original source sound by using the Delay.

Chorus:

This makes the one original sound appear to have many sources. The Chorus is used to widen or thicken the original sound.

Flanger:

The Flanger is one of applications of the Delay.

This is used to create a sound like a jet airplane ascending or descending.

* A. S. P.

(Fostex Advanced Signal Processing Technology)



The A. S. P. is an exclusive new digital effect processing technology designed by Fostex. This method extracts maximum efficiency from the limited DSP power.

It achieves an overwhelmingly high density Early Reflection sound and wonderfully smooth High Dump response through the H. F. A. (Harmonic Feedback Algorithm). Also, it carries out an elaborate reverb simulation with clear sounds through the H. D. L. P. (Hi-Density Logarithmic Processing), which eliminates the mutual interference between the numerous integrated delay modules and reduce the impurity and girt of the sound.

* H. F. A. (Harmonic Feedback Algorithm)

There is one of indispensable elements in the natural echo called "Early Reflection Sound," which is usually sacrificed in commercial reverb products in order to reduce costs. (In practice, the Early Reflection Sound means the very first reverberated sound that bounces back from walls, floors and ceilings of concert halls). The entire reverb sound quality depends on this Early Reflection Sound and how closely it can resemble the real echo. The H. F. A. is an algorithm that enables the effect unit to reproduce a clear and natural Early Reflection Sound by applying an ideal harmonic feedback to each delay module.

* H. D. L. P. (Hi-Density Logarithmic Processing)

The reverb sounds consist of lots of small delay elements combined in a complex way, which are produced by many delay modules inside the effect unit. In order to obtain smooth and comfortable reverb sounds, it is very important to efficiently organize the relationship between each delay module and minimize negative mutual interference. The H. D. L. P. is a technology which applies efficient logarithmic processing to each delay module, so that they can work in the most efficient way in order to eliminate harmful reverb elements and roughness. This makes it possible to establish high density and transparent sounds.

<Hint>

In effect editing, pressing the [EFFECT] key switches the setting screen shown on the LCD display in the following order. "Effect send level setting screen" -> "Effect type/parameter setting screen" -> "Effect send pre/post setting screen"

On each screen, you can edit parameters.

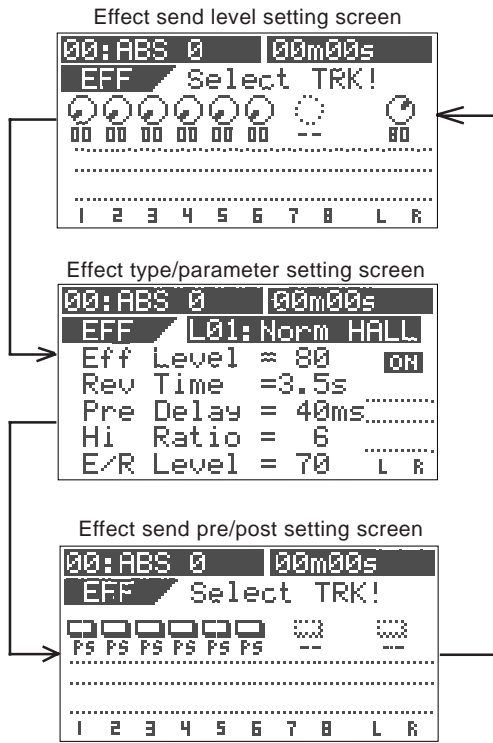

- 2 Select the desired track by pressing the corresponding [TRACK STATUS/TRACK SEL] key (or using the [CURSOR </>] keys).

The icon of the selected track is highlighted, indicating that you can edit it.

In the default settings, the send levels for Tracks 1 through 6 are "00" while the level for Master is "80."

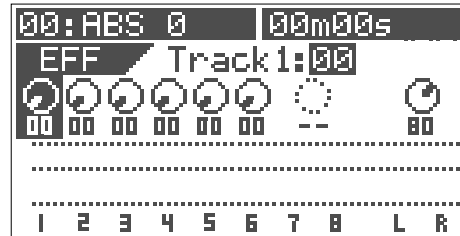

- 3 Use the [JOG] dial to adjust the send level value. The knob icon also rotates according to the level value. When the level is set to "00", no signal is sent to the effect processor.

• Editable tracks:	Tracks 1 through 6
• Level range:	00 through 99 in 1 step
• Default level:	Tracks 1 through 6: 00, Master: 80

- 4 To edit the send level for another track, repeat steps 2 and 3 above.
- 5 To edit the effect send master level, press the [STATUS/SEL] key of the master to highlight the master level icon, and then use the [JOG] dial to edit the value. The default level value is "80."
- 6 After completing send level settings, press the [EXIT/NO] key. The LCD display returns to the Normal screen.

Setting effect send levels

You can set send levels from Tracks 1 through 6 to the internal A.S.P. effect processor.

- 1 Press the [EFFECT] key to bring up the send level setting screen.

If you have not edited any track parameter for effect send, EQ or pan setting after turning on the power last time, the message prompting to select a track ("Select TRK!") blinks, as well as the [TRACK STATUS/TRACK SEL] keys for Tracks 1 through 6 on the panel flash.

If you have edited any track parameter for effect send, EQ or pan setting after turning on the power last time, the icon for the previously edited track is highlighted, showing that it can be edited.

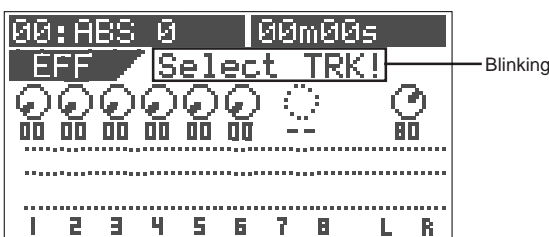

Selecting an effect type

- 1 Press the [EFFECT] key to bring up the effect type/parameter setting screen. The first time you bring up the screen, "L01: Norm HALL" is selected as the effect type. From the second time on when bringing up the screen, the previously selected effect type is selected.

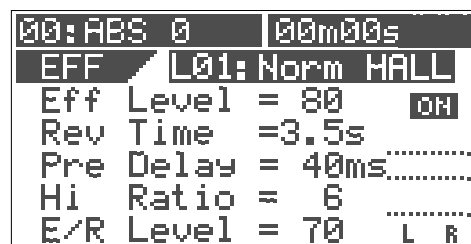

- 2 Use the [JOG] dial to select the desired effect type. You can select an effect type from among L01 through L38. When you select a type other than the current type, the type blinks.

- Press the [ENTER/YES] key after selecting the effect type.
Now you can edit the first parameter.
In the example below, the "Eff Level" value is highlighted showing that it can be edited.

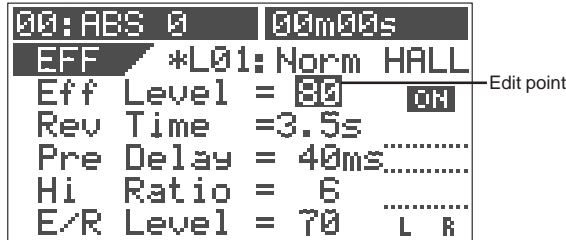

- Use the [JOG] dial to select a value for the highlighted parameter.
See "Effect parameter details" about the available parameter values.
- To set a value for another parameter, use the [CURSOR /down] key to select a parameter to be edited, and then use the [JOG] dial to select a value.
- After completing the settings, press the [EXIT/NO] key. The VF08 exits the edit mode and the LCD display returns to the Normal screen.

Selecting Pre/Post of the effect send

You can select the send signals from Tracks 1 through 6 pre- or post- fader.
When selecting Post, a signal after the track fader is sent to the effect processor. So if you set the fader completely down, no signal is sent to the effect processor.
When selecting Pre, a signal before the track fader is sent to the effect processor. So even if you set the fader completely down, the signal is sent to the effect processor.

- Press the [EFFECT] key to bring up the pre/post setting screen.
If you have not edited any track parameter for effect send, EQ or pan setting after turning on the power last time, the message prompting to select a track ("Select TRK!") blinks, as well as the [TRACK STATUS/TRACK SEL] keys for Tracks 1 through 6 on the panel flash.
If you have edited any track parameter for effect send, EQ or pan setting after turning on the power last time, the switch icon for the previously edited track is highlighted, showing that it can be edited.

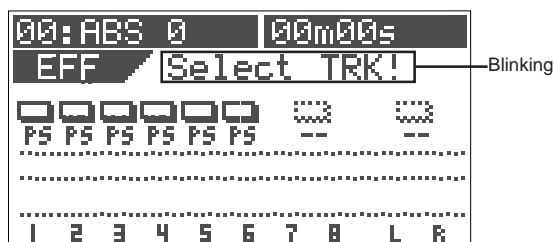

- Select the desired track by pressing the corresponding [TRACK STATUS/TRACK SEL] key (or using the [CURSOR </>] keys).
The switch icon of the selected track is highlighted, indicating that you can edit it.
In the default settings, all Tracks 1 through 6 are set to "Post."

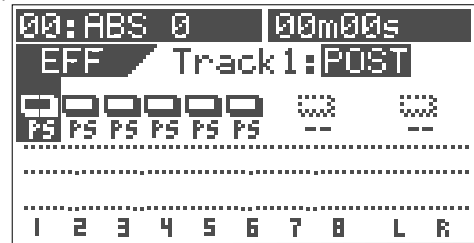

- Use the [JOG] dial to select "Pre" or "Post."
The icon changes according to the selection as below.

	Pre fader signal is sent to the effect processor.
	Post fader signal is sent to the effect processor.
<ul style="list-style-type: none"> Selectable tracks: Tracks 1 through 6 Setting values: PRE or POST (the default is POST). 	

Turning the effect processor on or off

You can select the on or off of the effect processor.

* To turn on the effect processor

Press the [EFFECT/ON/OFF] key while holding down the [SHIFT] key to illuminate the [EFFECT/ON/OFF] key. The effect processor is turned on and you can hear "wet" sound.

*To turn off the effect processor

Press the [EFFECT/ON/OFF] key while holding down the [SHIFT] key to illuminate the [EFFECT/ON/OFF] key. The effect processor is turned off and you can hear "dry" sound.

You can also see the on/off status of the effect processor in the effect type/parameter setting screen.

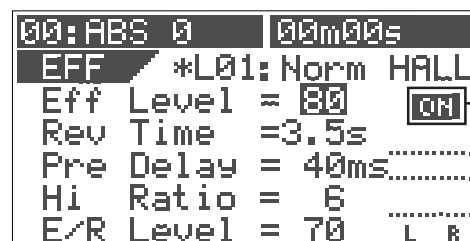

This icon shows the on/off status of the effect processor.

Mixer Functions

About the effect types

A variety of effect types are preset for effect unit. By selecting a suitable effect type, you can process the sound as you wish. You can also edit the parameters of the selected effect type to create your own effect sounds.

	Name	Parameter type	Explanation
L01	Norm HALL	REVERB	Standard hall reverb; detailed and transparent, with a moderate amount of early reflections.
L02	Pres HALL	REVERB	Hall reverb with presence and definition.
L03	Wet HALL	REVERB	Hall reverb with restrained high-frequency and a refreshing atmosphere.
L04	NoER HALL	REVERB	All-purpose hall reverb with no early reflections, and even decay of all frequencies.
L05	Lo-F HALL	REVERB	Hall reverb with lingering low-frequency reverberation.
L06	STADIUM	REVERB	Stadium reverb characterized by long early reflections.
L07	AUDITORIUM	REVERB	Reverb simulating an auditorium with suppressed reverberation.
L08	HALL WAY	REVERB	Reverb with a long pre-delay, creating the impression of an extended space.
L09	Norm ROOM	REVERB	Room reverb simulating a moderate space with some sparkle.
L10	Dead ROOM	REVERB	Room reverb simulating a narrow and dead room. Adding a slight amount will give warmth to the sound.
L11	Pres ROOM	REVERB	All-purpose room reverb, with good definition and few early reflections.
L12	DrumBOOTH	REVERB	Room reverb simulating a drum booth.
L13	GARAGE	REVERB	Room reverb simulating a narrow and live space like a garage, with crisp presence.
L14	NormPLATE	REVERB	Modern-sounding plate reverb with wide bandwidth.
L15	Old PLATE	REVERB	Standard plate reverb with the character of older plate units.
L16	PresPLATE	REVERB	Plate reverb with good definition and extended high-frequencies.
L17	Wet PLATE	REVERB	Plate reverb with a gentle character.
L18	DigiPLATE	REVERB	Plate reverb that emphasizes a digital character, with metallic early reflections.
L19	NormVOCAL	REVERB	All-purpose hall reverb with no early reflections, and uniform decay at all frequencies.
L20	PresVOCAL	REVERB	Short reverberation with extended high frequency is added to the early reflections of an ideal vocal booth. Since this adds sparkle to the sound, it is effective when you wish to bring the vocal to the forefront.
L21	SoloVOCAL	REVERB	Plate-like reverb is added to a spacious short delay. This blends well with any genre of music.
L22	Arena VOC	REVERB	Gentle reverb is added to spacious stadium-type early reflections.
L23	Arena CHO	REVERB	Short reverb with extended high frequency is added to spacious stadium-type early reflections. Effective on chorus parts.
L24	KARAOKE	REVERB	All-purpose reverb (karaoke style) that makes any vocal sound professional.
L25	MnDL-HALL	DLY+REVERB	A combined effect of mono delay and hall reverb.
L26	MnDL-PLT	DLY+REVERB	A combined effect of mono delay and plate reverb.
L27	PnDL-HALL	DLY+REVERB	A combined effect of panning delay and hall reverb.
L28	PnDL-PLT	DLY+REVERB	A combined effect of panning delay and plate reverb.
L29	MonoDELAY	DELAY	Mono delay
L30	PanDELAY	DELAY	Panning delay
L31	MonoBpmDL	BPM DELAY	Mono delay. Specify BPM and note value to set the delay time.
L32	PanBpmDL	BPM DELAY	Panning delay. Specify BPM and note value to set the delay time.
L33	Short DL	SHORT DELAY	Short delay that allows you to set the delay time precisely.
L34	DOUBLING	DOUBLING	Doubling that allows you to set separate delay times for L and R.
L35	CHORUS	CHORUS	Produces a chorus effect. A doubling effect can also be added.
L36	FLANGE	FLANGE	Produces a flanging effect.
L37	MonoPITCH	MONO PITCH	Pitch shift adjustable in a +/-2 octave range.
L38	DlyPITCH	DELAY PITCH	Pitch shift with a feedback delay, allowing strange effects to be produced.

Effect parameter details

The parameters that can be adjusted will depend on the parameter type.

Reverb effect parameters (parameter type: REVERB)

For effect types 1–24 of the preceding "Effect type" table, the following four parameters can be adjusted.

- | | |
|--------------|---|
| 1. Eff Level | Adjust the effect return level: 0–99 |
| 2. Rev Time | Adjust the length of reverberation. Range: 0.1–9.9 seconds |
| 3. Pre Delay | Adjust the time from the original sound until reverberation begins. Range: 0–100 ms |
| 4. Hi Ratio | Adjust the decay ratio of the high frequencies. Range: 0–10 |
| 5. E/R Level | Adjust the volume of the early reflections. Range: 0–99 |

Delay+reverb effect parameters (parameter type: DELAY+REVERB)

For effect types 25–28 of the preceding "Effect type" table, the following four parameters can be adjusted.

- | | |
|---------------|--|
| 1. Eff Level | Adjust the effect return level: 0–99 |
| 2. Delay Time | Adjust the delay time: Range: 1–230 ms |
| 3. Feedback | Adjust the number of delay repeats. Range: 0–99 |
| 4. Delay Bal | Adjust the delay balance. Range: 0–99 |
| 5. Rev Time | Adjust the length of reverberation. Range: 0.1–9.9 seconds |

Delay effect parameters (parameter type: DELAY)

For effect types 29 and 30 of the preceding "Effect type" table, the following four parameters can be adjusted.

- | | |
|---------------|--|
| 1. Eff Level | Adjust the effect return level: 0–99 |
| 2. Delay Time | Adjust the delay time. Range: 1–680 ms |
| 3. Feedback | Adjust the number of delay repeats. Range: 0–99 |
| 4. Hi Ratio | Adjust the decay ratio of the high frequencies. Range: 0–10 |
| 5. Filter | Adjust the tone of the delay sound. Range: L9–L1, OFF, H1–H9 |
- * L1–L9 = LPF (larger numbers will lower the cutoff frequency)
* H1–H9 = HPF (larger numbers will raise the cutoff frequency)

BPM delay effect parameters (parameter type: BPM DELAY)

For effect types 31 and 32 of the preceding "Effect type" table, the following four parameters can be adjusted.

- | | |
|--------------|--|
| 1. Eff Level | Adjust the effect return level: 0–99 |
| 2. BPM | Adjust the BPM. Range: 30–250 bpm |
| 3. Note | Select the note value for the delay. Range: 24, 16, 8T, 16..8, 4T, 8., 4, 2T, 4., 2, 2., 1 |
| 4. Feedback | Adjust the number of delay repeats. Range: 0–99 (100 steps in increments of 1) |
| 5. Filter | Adjust the tone of the delay sound. Range: L9–L1, OFF, H1–H9 |
- * 24 = 16th note sextuplets, 16 = 16th notes, 8T = 8th note triplets, 16. = dotted sixteenth notes, 8 = 8th notes, 4T = quarter note triplets, 8. = dotted eighth notes, 4 = quarter notes, 2T = half-note triplets, 4. = dotted quarter notes, 2 = half notes
* The "." shown in the ninth character of the LCD indicates a dotted note.
* The "T" shown in the ninth character of the LCD indicates a triplet.
* L1–L9 = LPF (larger numbers will lower the cutoff frequency)
* H1–H9 = HPF (larger numbers will raise the cutoff frequency)

Short delay effect parameters (parameter type: SHORT DELAY)

For effect type 33 of the preceding "Effect type" table, the following four parameters can be adjusted.

- | | |
|---------------|--|
| 1. Eff Level | Adjust the effect return level: 0–99 |
| 2. Delay Time | Adjust the delay time. Range: 0.1–9.9 ms, 10–99 ms, 100–200 ms |
| 3. Feedback | Adjust the number of delay repeats. Range: 0–99 |
| 4. Hi Ratio | Adjust the decay ratio of the high frequencies. Range: 0–10 |
| 5. Filter | Adjust the tone of the delay sound. Range: L9–L1, OFF, H1–H9 |
- * L1–L9 = LPF (larger numbers will lower the cutoff frequency)
* H1–H9 = HPF (larger numbers will raise the cutoff frequency)

Doubling effect parameters (parameter type: DOUBLING)

For effect type 34 of the preceding "Effect type" table, the following three parameters can be adjusted.

- | | |
|--------------|---|
| 1. Eff Level | Adjust the effect return level: 0–99 |
| 2. Lch Delay | Adjust the delay time of the L channel. Range: 0.1–9.9 ms, 10–99 ms, 100–200 ms |
| 3. Rch Delay | Adjust the delay time of the R channel. Range: 0.1–9.9 ms, 10–99ms, 100–200 ms |
| 4. Filter | Adjust the tone of the delay sound. Range: L9–L1, OFF, H1–H9 |
- * L1–L9 = LPF (larger numbers will lower the cutoff frequency)
* H1–H9 = HPF (larger numbers will raise the cutoff frequency)

Mixer Functions

Chorus effect parameters (parameter type: CHORUS)

For effect type 35 of the preceding "Effect type" table, the following four parameters can be adjusted.

- | | |
|----------------|--|
| 1. Eff Level | Adjust the effect return level: 0-99 |
| 2. Depth | Adjust the chorus depth. Range: 0-99 |
| 3. Double Time | Adjust the time difference of the doubling effect. Range: 0-99 |
| 4. Double Lvl | Adjust the volume of the doubling effect. Range: 0-99 |
| 5. Filter | Adjust the tone of the delay sound. Range: L9-L1, OFF, H1-H9
* L1-L9 = LPF (larger numbers will lower the cutoff frequency)
* H1-H9 = HPF (larger numbers will raise the cutoff frequency) |

Flanger effect parameters (parameter type: FLANGE)

For effect type 36 of the preceding "Effect type" table, the following four parameters can be adjusted.

- | | |
|--------------|--|
| 1. Eff Level | Adjust the effect return level: 0-99 |
| 2. Rate | Adjust the speed of modulation. Range: 0.01-2.00 Hz |
| 3. Depth | Adjust the depth of modulation. Range: 0-99 |
| 4. Mod Delay | Adjust the modulation delay. Range: 0-200 |
| 5. Feedback | Adjust the number of modulation repeats. Range: 0-99 |

Mono pitch effect parameters (parameter type: MONO PITCH)

For effect type 37 of the preceding "Effect type" table, the following three parameters can be adjusted.

- | | |
|--------------|---|
| 1. Eff Level | Adjust the effect return level: 0-99 |
| 2. Pitch | Adjust the amount of pitch shift. Range: -24-0--+24
* +/-12 is one octave. +/-24 is two octaves. |
| 3. Adjust | Make fine adjustments to the amount of pitch shift. Range: -50-0--+50
* +50 is a semitone sharp. -50 is a semitone flat. |
| 4. Mode | Select the processing method. Range: 1-3 |

Delay pitch effect parameters (parameter type: DELAY PITCH)

For effect type 38 of the preceding "Effect type" table, the following four parameters can be adjusted.

- | | |
|---------------|---|
| 1. Eff Level | Adjust the effect return level: 0-99 |
| 2. Pitch | Adjust the amount of pitch shift. Range: -24-0--+24
* +/-12 is one octave. +/-24 is two octaves. |
| 3. Adjust | Make fine adjustments to the amount of pitch shift. Range: -50-0--+50
* +50 is a semitone sharp. -50 is a semitone flat. |
| 4. Delay Time | Adjust the delay time until the pitch-shifted sound is heard. Range: 0-500 ms |
| 5. Feedback | Adjust the number of delay repeats. Range: 0-99 |

Scene memory

The VF08 provides 100 Scene memories (S00 to S99) for each program. You can store a set of desired parameter settings to each memory. Items to be stored include all parameters set by mix parameter editing functions, as well as all track fader levels. In addition to 100 Scene memories, the VF08 also provides 10 Temporary memories (T00 to T09) that can be used with all programs in common. Note that all settings stored in Temporary memories disappear when turning off the power.

You can give a desired title (name) with up to 16 alphanumeric or symbolic characters to each Scene/Temporary memory. (Note that up to 11 characters can be shown on the display.)

Storing the current scene

You can store the current scene (settings) to a Scene or Temporary memory by using the following procedure.

<Hint>

Scene memories (shown as S00 through S99 on the list) are retained even if the power is turned off, while Temporary memories (shown as T00 through T09 on the list) disappear when the power is turned off, though they do not disappear when changing the program. If you want to store a Temporary memory to a Scene memory (S00 to S99), recall the temporary number before turning off the power and store the settings to the desired Scene memory number.

- 1 Press the [SCENE] key. The display shows the screen for selecting the desired scene number.



- 2 Use the [JOG] dial to select the desired scene number to which you want to store the current settings, and press the [TIME BASE SEL/F2] key while holding down the [SHIFT] key. (In the following example, "S01" is selected.)

The scene name of the program which you worked with before entering the scene memory mode is duplicated to the name of the selected scene number, whose leftmost character blinks, showing that it can be edited.

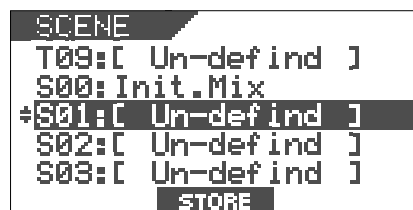

- 3 Enter the desired scene name by using the [JOG] dial for selecting a character and using the [CURSOR </>] keys for moving the editing (blinking) point.

You can specify a scene name with up to 16 alphanumeric or symbolic characters and can see up to 14 characters on the display. The following characters can be entered:

A to Z, a to z, 0 to 9, + - * / # & ! ? () [] < > : . , etc.

- 4 After completing the scene name entry, press the [TIME BASE SEL/F2] key while holding down the [SHIFT] key.

The display changes to the Normal display of the program whose scene name has just been set.

Recalling a scene

You can recall the settings stored in Scene or Temporary memories.

<Cautions>

- If the "Fader recall On/Off setting" menu described later is set to "OFF", when recalling a desired scene memory, fader settings are not recalled, while "Scene Recalled Fader RCL OFF" is momentarily shown on the screen.
- If the "Fader recall On/Off setting" menu is set to "ON", regardless of the current physical positions of track and master faders, the audio is output at the fader positions when they were stored. We suggest you to turn the monitor volume down when recalling a scene memory to prevent an accidentally accessing high-volume sound.

- 1 Press the [SCENE] key. The display shows the screen for selecting the scene number.



Mixer Functions

- 2 Use the [JOG] dial to select the desired scene number to be recalled.
- 3 Press the [SETUP/F1] key while holding down the [SHIFT] key.
The selected scene is recalled and the display changes to the Normal display.

Deleting a scene

You can delete an unnecessary Scene or Temporary memory by using the following procedure.

<Notes>

- You cannot delete the memory in scene number 00. If you select scene number 00 and try to delete the memory, "DELETE" does not appear on the display.
- You cannot undo deleting a scene. Be sure not to select a wrong scene number to be deleted.

- 1 Press the [SCENE] key.
The display shows the scene number/title list.



- 2 Select a memory to be deleted using the [JOG] dial.

- 3 Press the [UNDO/REDO/E3] key while holding down the [SHIFT] key.
The message asking for confirmation to delete the scene appears and "Sure?" blinks.

To cancel to delete the mark, press the [EXIT/NO] key now.

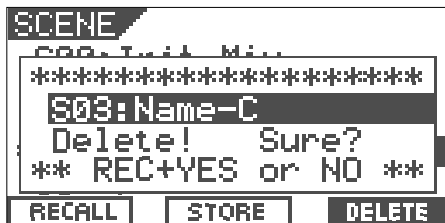

- 4 Press the [ENTER/YES] key while holding down the [RECORD] key.
The selected memory is deleted and the scene name changes to "[Un-defined]", showing that no memory is stored.

- 5 Press the [EXIT/NO] key.
The display returns to the Normal screen.

Fader adjust

After recalling a scene, the recalled fader level usually does not match the current physical fader position, you can move the physical faders to match the current fader positions of the scene.

The following description is assumed that "Fader recall setting" of the setup mode is set to "Trk & Mst."

- 1 Press the [SCENE/FADER] key while holding down the [SHIFT] key.

The display shows the fader setting screen.

The fader icon changes according to the relation between the physical fader position and recalled fader position, as show below.

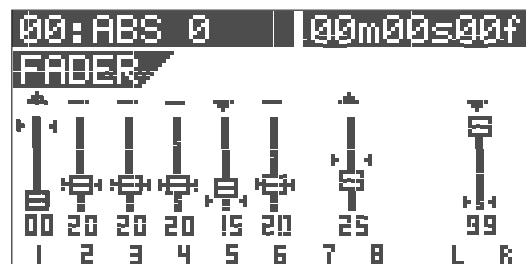

•The current physical fader position is lower than the recalled position.

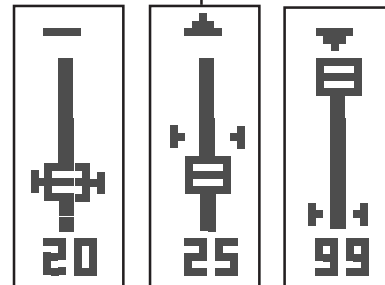

•The current physical fader position matches the recalled position.

•The current physical fader position is higher than the recalled position.

- 2 Move a physical fader manually to match the recalled (scene memory) position.

- 3 After adjusting all the fader positions, press the [EXIT/NO] key.

<Note>

If you recall a scene when "Fader recall setting" of the setup mode is set to "OFF", the current physical fader positions are valid.

Scene sequence

Using the scene sequence function, you can recall desired scene memories at the desired mark positions during playback. For example, you can recall scene memory 02 at "Bar 17/Beat 1" and scene memory 04 at "Bar 25/Beat 1", etc. To execute the scene sequence function, you must first assign scene (or temporary) memories to marks in the mark map. If you set the timebase to Bar/Beat/Clk, you can assign scene memories to be recalled to the musical positions (Bar/Beat/Clk numbers). Of course, you may set the timebase to ABS.

*<Note>
You must store data to scene memories before assigning to the mark map.*

Assigning scene memories to the mark map

In the following description, we assume that the timebase is set to Bar/Beat/Clk.

- 1 While the recorder is stopped, press the [SCENE SEQ/MAP] key while holding down the [SHIFT] key. The screen shows the mark map, in which the current marks are listed. In the mark map example below, only scene memory 00 is assigned to mark 00. ("Non" means that no memory is assigned to the corresponding mark.)

MARK MAP		
00:	-2BAR 1/00	S00
01:	012BAR 1/00	Non
02:	020BAR 4/30	Non
03:	028BAR 6/46	Non
04:	046BAR 3/00	Non

LOCATE

*<Hint>
You can view mark titles instead of mark positions (in bar/beat/clock base or ABS time base) in the mark map. Pressing the [TIME BASE SEL] key while the mark map screen is shown switches mark positions and mark titles.*

- 2 Select the desired mark using the [JOG] dial, and then press the [TIME BASE SEL/F2] key while holding down the [SHIFT] key. The display shows the screen for editing the selected mark.

MARK MAP		
00:	-2BAR 1/00	S00
01:	012BAR 1/00	Non
02:	020BAR 4/30	Non
*03:	028BAR 6/46	Non
04:	046BAR 3/00	Non

LOCATE EDIT DELETE

MARK MAP		MARK03 Edit
028BAR	6/46CLK	
Name =	*****	
Scene =	Non	

Hit ENTER or EXIT

- 3 Highlight "Non" using the [CURSOR </>] keys, and then select the desired scene number to be assigned to the mark using the [JOG] dial. When selecting a scene number which holds data, its scene title is also shown below the scene number.

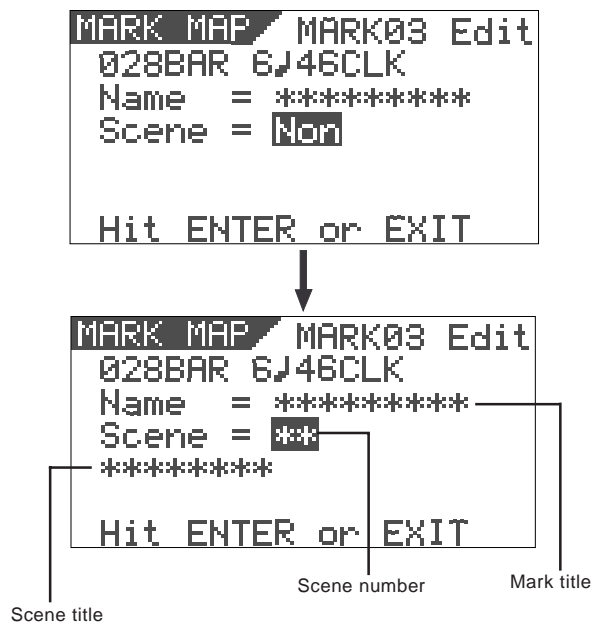

- 4 After selecting the scene number, press the [ENTER/YES] key. Repeat steps 1 through 4 to assign scene numbers to other marks.

In the example below, several scene numbers are assigned to marks and you are ready for executing the scene sequence function described later.

MARK MAP		
00:	-2BAR 1/00	S00
01:	012BAR 1/00	S02
02:	020BAR 4/30	S06
*03:	028BAR 6/46	S04
04:	046BAR 3/00	S03

LOCATE EDIT DELETE

- 5 Press the [EXIT/NO] key after assigning all desired scenes to marks.

Deleting a mark from the mark map

You can delete an unnecessary mark from the mark map.

<Note>

You cannot delete mark 00.

- 1 While the VF08 is stopped, press the SCENE SEQ/MAP key while holding down the SHIFT key. The screen shows the mark map.
- 2 Highlight the desired mark using the [JOG] dial.
- 3 Press the [UNDO/REDO/F3] key while holding down the [SHIFT] key. The message asking for confirmation to delete the mark appears and "Sure?" blinks. To cancel to delete the mark, press the [EXIT/NO] key now.
- 4 Press the [ENTER/YES] key while holding down the [RECORD] key. The map is deleted and the following marks are renumbered.

Scene sequence on/off selection

You can turn on or off the scene sequence function for selecting whether or not performing the scene sequence function using the mark map.

- 1 While the VF08 is stopped, press the [SCENE SEQ] key. The [SCENE SEQ] key lights in green, showing that the scene sequence function is active (ON).

Each time you press the [SCENE SEQ] key, ON and OFF alternates.

When turning on the scene sequence function, "SCENE SQ: ON" appears momentarily on the Normal display and then the scene number is highlighted.

When turning off the scene sequence function, "SCENE SQ: OFF" appears momentarily on the Normal display and then the highlighted scene number returns to the Normal screen

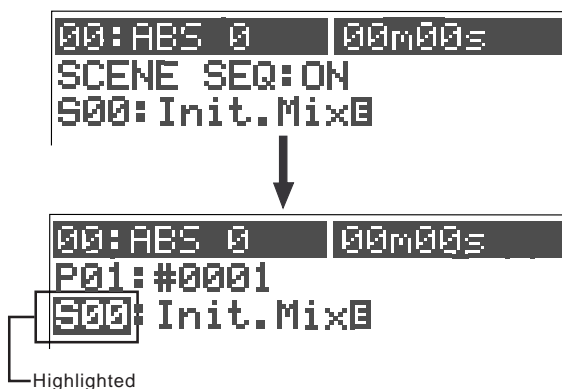

Executing the scene sequence

If you start playback while the scene sequence function is active (ON), the scenes will be recalled according to the mark map.

<Note>

When executing the scene sequence, the fader positions may be recalled or not according to the fader recall mode setting in the setup mode (the default is "OFF"). For example, if you set the fader recall mode to "ON", both the track and master faders are automatically recalled every time the current scene changes. On the contrary, if you set the fader recall mode to "OFF" (the default mode), fader positions are not recalled so you can manually control fader positions as you like. We suggest you to make sure to set the fader recall mode suitably for your work before executing the scene sequence. See "Fader recall mode setting" on page 110 for details.

<Screen appearances during playback>

The following show the screen appearances during playback with the mark map in which scene number 02 (with the title "BBBB") is assigned to "Bar 12, Beat 1" and scene number 06 (with the title "CCCC") is assigned to "Bar 20, Beat 4."

```
00: Intro -2BAR 1J
P01: #0001
S00: Init.MixE
```

The unit starts playback from "Bar -2, Beat 1" with the settings stored in scene number 00 (Init Mix).

```
03: Guitar 12BAR 1J
P01: #0001
S02: BBBB
```

The unit recalls scene number 02 (BBBB) at "Bar 12, Beat 1" and continues playback.

```
05: Piano 20BAR 4J
P01: #0001
S08: CCCC
```

The unit recalls scene number 06 (CCCC) at "Bar 20, Beat 4" and continues playback.

<Hint>

The unit continues playback with the settings stored in the scene number recalled last time. Therefore, if you want to recall scene number 00 again after recalling scene number 06 above, you have to assign scene number 00 to the desired mark.

Recorder Functions

This chapter describes various recorder functions.

Cueing

The cueing function allows you to monitor audio at higher or lower speed.

Cueing with the [F FWD]/[REWIND] keys

By pressing the [F FWD] or [REWIND] key during playback, you can monitor (cue) the sound at 3 times the normal speed.

- 1 Press the [PLAY] key to start playback.
- 2 Press the [F FWD] or [REWIND] key during playback. The VF08 starts "cueing" at 3 times the normal speed, while "FWD" or "RWD" appears on the screen.

The VF08 is "cueing" in the forward direction.

```

00+ABS 0  ***m***s
P01:#0001
S00:Init.Mix0
  FWD >
-----
-----
-----
1 2 3 4 5 6 7 8 L R
  
```

The VF08 is "cueing" in the backward direction.

```

00+ABS 0  ***m***s
P01:#0001
S00:Init.Mix0
  < RWD
-----
-----
-----
1 2 3 4 5 6 7 8 L R
  
```

- 3 To return to the normal playback, press the [PLAY] key.

Shuttle cueing

During playback, "shuttle cueing" is possible at the speed between 1 and 64 times the normal speed.

- 1 Press the [PLAY] key to start playback.
- 2 Rotate the [JOG/SHUTTLE] dial while holding down the [SHIFT] key.

- Rotating the [JOG/SHUTTLE] dial clockwise moves the position to the forward direction, while rotating the dial counter-clockwise moves the position to the backward direction.
- According to the rotating degree, the cueing speed varies among 1x, 2x, 4x, 8x, 16x, 32x, and 64x. The current cueing speed is shown on the screen.
- As long as holding down the [SHIFT] key, shuttle cueing continues even if you release the [JOG/SHUTTLE] dial.

The VF08 is "cueing" in the forward direction at 64x the normal speed.

```

00+ABS 0  ***m***s
P01:#0001
S00:Init.Mix0
  FWD >64
-----
-----
-----
1 2 3 4 5 6 7 8 L R
  
```

The VF08 is "cueing" in the backward direction at 64x the normal speed.

```

00+ABS 0  ***m***s
P01:#0001
S00:Init.Mix0
  64< RWD
-----
-----
-----
1 2 3 4 5 6 7 8 L R
  
```

The VF08 is still.

```

00+ABS 0  ***m***s
P01:#0001
S00:Init.Mix0
  < STILL >
-----
-----
-----
1 2 3 4 5 6 7 8 L R
  
```

- 3 To return to the normal playback, press the [PLAY] key.

<Remember!>

Once the data is rewound to the beginning of a program (ABS 0), playback starts from the beginning of the program, regardless of pressing the [SHIFT] key. When reaching the end of a program (ABS: 23H 59M 59S), the program stops and the [PLAY] key flashes.

Digital scrubbing

Digital scrubbing can be done between 0x and 1x speed without changing the pitch while the VF08 is stopped.

You can scrub audio track by track. The level envelope of the scrub track is shown on the screen, allowing you to locate the beginning of a song or interval of songs easily.

Furthermore, you can use the position located by digital scrubbing as an edit point for the track editing functions or auto-punch in/out.

Performing digital scrubbing

- 1 While stopped, press the [WAVE FORM SCRUB] key. The VF08 enters the scrub mode, and the display shows the screen below.



- 2 Press the [TRACK STATUS/TRACK SEL] key for the track you are going to scrub. The level envelope of audio recorded on the selected track is shown. When the VF08 is stopped, "<STILL>" is also shown.

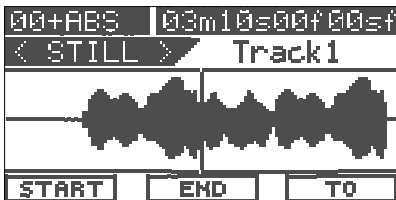

- 3 By rotating the [JOG] dial, you can scrub audio of the selected track. The vertical line in the center shows the current position, and you can hear scrubbing audio from this position to either the forward or backward direction. When rotating the [JOG] dial clockwise, "Scrub >" is shown. When rotating the [JOG] dial counter-clockwise, "<Scrub" is shown. The cursor (the vertical line) moves while scrubbing, while the time value (or bar/beat) of the current position is shown in realtime.

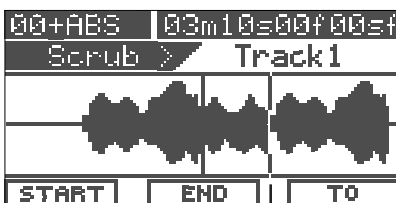

current scrubbing position

- 4 If you want to scrub another track, repeat steps 2 and 3.

Storing the digital scrub point

You can store the scrub point to the Start, End or To point for track editing functions (such as Copy, Move, Paste and Erase), or the auto-punch in point.

- **To store the scrub point to the Start point:**
Press the [SETUP/E1] key while holding down the [SHIFT] key. "Edit Start Point Stored!" is shown briefly and then the scrub point is stored to the Start point for track editing.

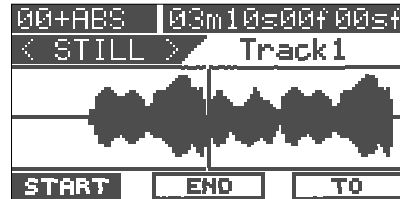

- **To store the scrub point to the End point:**
Press the [TIME BASE SEL/F2] key while holding down the [SHIFT] key. "Edit End Point Stored!" is shown briefly and then the scrub point is stored to the End point for track editing.

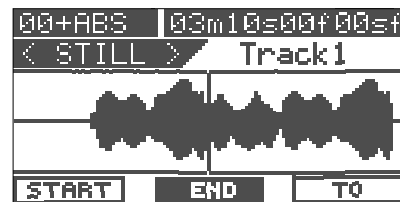

- **To store the scrub point to the To point:**
Press the [UNDO/REDO/E3] key while holding down the [SHIFT] key. "Edit To Point Stored!" is shown briefly and then the scrub point is stored to the To point, which can be used as the starting point of Paste or the auto-punch In point.

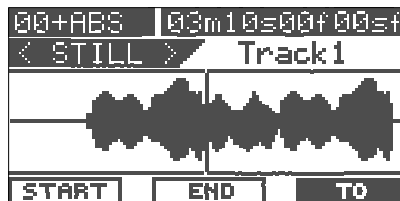

- After storing the point, press the [EXIT/NO] key. The display returns to the Normal screen that was shown when finishing scrubbing.

<Hint>

- You can also store the point by pressing the [ENTER/YES] key after highlighting "START", "END" or "TO" by using the [CURSOR >] or [CURSOR <] key.
- By pressing the [MARK] key while holding down the [SHIFT] key, you can store the scrub point to a mark memory.

Vari Pitch

You can alter the playback or recording speed of the recorder within +/- 6.0 % range in 0.1 % increments/decrements by using the vari pitch function. With the vari pitch function, the pitch changes according to the speed.



Turning on or off the vari pitch function

- 1 Press the [VARI PITCH/EDIT] key.
The key lights up in green, showing the vari pitch function is active.
- 2 Press the [VARI PITCH/EDIT] key again.
The key turns off, showing the vari pitch function is not active.

<Note>

You can turn on or off the vari pitch function while stopped or during playback, however, you cannot turn on or off the function during recording.

Setting the speed

You can adjust the speed while stopped or during playback, however, you cannot adjust the speed during recording. If you adjust the speed during playback with the vari pitch function active, you can monitor the result of speed (pitch) change while adjusting.

- 1 While stopped or during playback, press the [VARI PITCH/EDIT] key while holding down the [SHIFT] key. The current pitch value is highlighted, showing that the value can be edited.

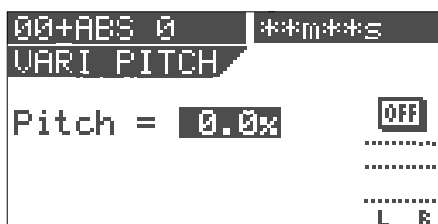

"ON" or "OFF" (of the vari pitch function) is also shown on the screen.

- 4 Use the [JOG] dial to enter the pitch value.
- 5 Press the [EXIT/NO] key to return to the Normal screen.

<Notes>

- Even if the pitch value is set to 0.0 % (no speed change), pressing the [VARI PITCH] key turns on the vari pitch function. In such a condition, the function is active but the speed is not changed.
- The vari pitch function automatically turns off by carrying out any of the following.
 1. Turning the power off and then on. (The pitch value is also reset to 0.0 %.)
 2. Setting the slave mode to "On" in the setup mode. (The pitch value is retained.)
Note that you cannot turn on the vari pitch function when the slave mode is "On".
 3. Setting the digital input to "On" in the setup mode ("DIGI IN" is shown on the screen).
Note that you cannot turn on the vari pitch function when the digital input is selected.

Recorder Functions

Loop Function

Using the loop function, you can repeat the desired part between the Start and End points. By using the loop function together with the punch in/out or training mode, you can concentrate on playing without the need for operating the VF08.

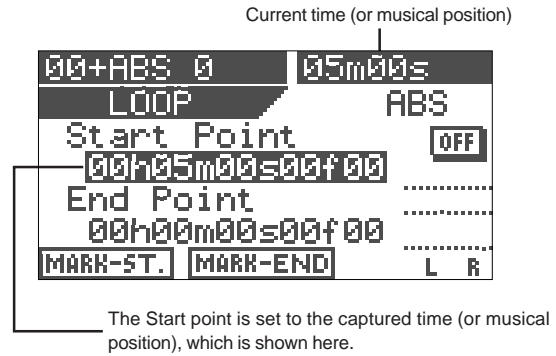
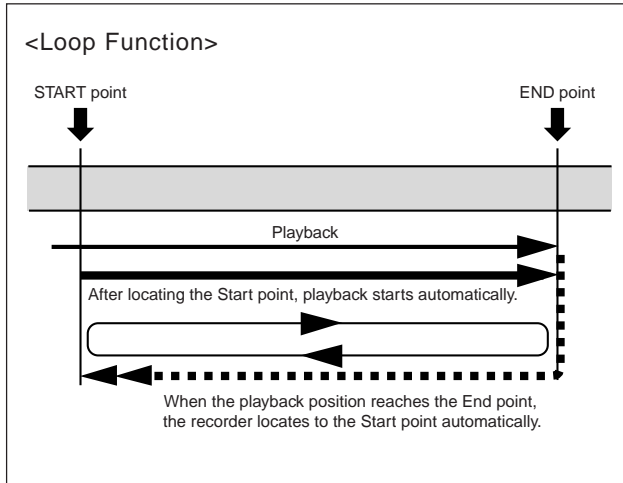

- At the point where you want to set the End point, press the [TIME BASE SEL/F2] key while holding down the [SHIFT] key. "End Point Stored!" briefly appears and the End point is set to the captured point.

Setting the Start and End points

There are following three methods for setting the Start and End points.

- Capturing the current position "On-the-fly"
- Editing the time (or musical position) via the screen
- Setting by marks

Capturing the current position "on-the-fly"

While stopped or running, you can set the Start or End point at the point you capture.

- Press the [LOOP/EDIT] key while holding down the [SHIFT] key. The display shows the loop screen in which you can set the Start and End points.

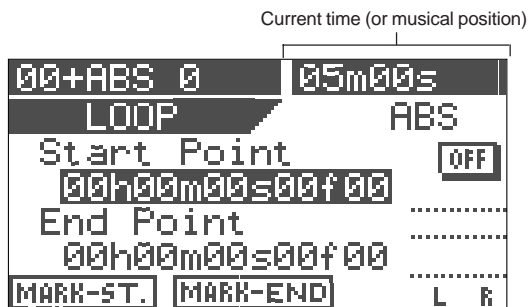

- At the point where you want to set the Start point, press the [SETUP/F1] key while holding down the [SHIFT] key. "Start Point Stored!" briefly appears and the Start point is set to the captured point.

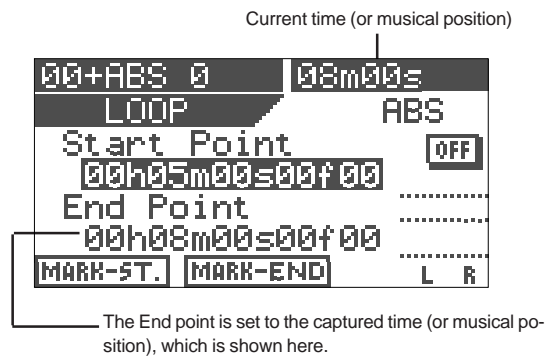

<Note>
The Start point must be earlier than the End point. Otherwise, the loop function cannot be performed.

Editing the position via the screen

In the following description, the recorder is assumed to be stopped and the ABS time base is selected.

- Press the [LOOP/EDIT] key while holding down the [SHIFT] key. The display shows the loop screen in which you can set the Start and End points.

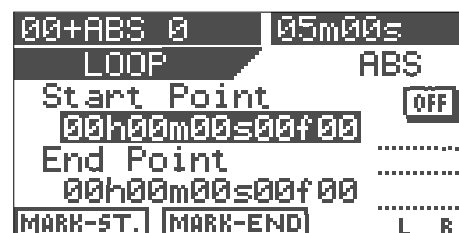

- To edit the Start point, press the [ENTER/YES] key while "Start Point" value is highlighted. The "seconds" value blinks, showing that it can be edited.

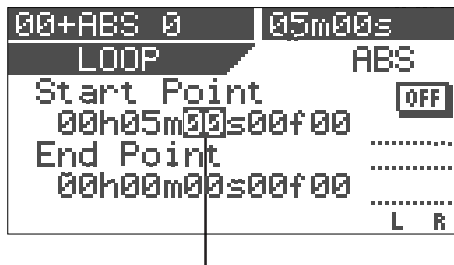

- Use the [CURSOR </>] keys to move the blinking value, and use the [JOG] dial to edit the value. You can also use the [CURSOR up/down] keys to edit the value.

- After editing all values, press the [ENTER/YES] key. The display returns to the similar screen shown in step 1 above, in which the Start point is set to the edited time.

- To edit the End point, use the [CURSOR down] key to highlight the "End point" value and carry out the same operations as steps 2 through 4 above.

*<Note>
As also noted in "capturing the current position on-the-fly", the Start point must be earlier than the End point. Otherwise, the loop function cannot be performed.*

Setting the Start and End points by marks
You can set the Start and End points by marks.

*<Note>
This method only can be used when any mark point is already stored.*

- While stopped, press the [LOOP/EDIT] key while holding down the [SHIFT] key. The display shows the loop screen in which you can set the Start and End points.

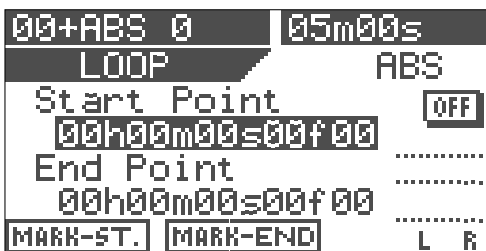

- Press the [TIME BASE SEL] key. Both the Start point and End point value fields show a mark (number and name).

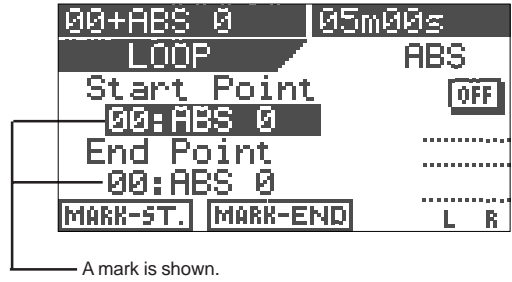

- Press the [ENTER/YES] key. The mark shown on the Start point value field starts blinking.

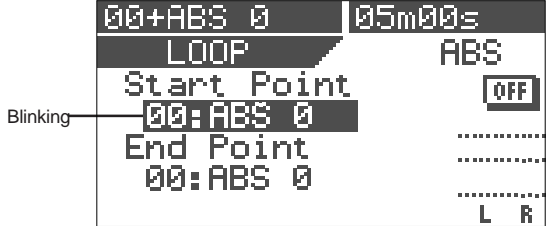

- Use the [JOG] dial to select the desired mark and press the [ENTER/YES] key. The Start point is set to the selected mark, while the display returns to the similar screen shown in step 2 above.

- To edit the End point, use the [CURSOR down] key to highlight the "End point" value and carry out the same operations as steps 3 through 4 above. The selected mark is set to the End point.

*<Hint>
When rehearsing the auto punch in/out, if you also activate the loop function in which the Start point is set to a point a little bit earlier than the In point while the End point is set to a point a little bit later than the Out point, you can rehearse the auto punch in/out repeatedly as many times as you like. The loop function is also useful when you make a practice using the training mode.*

Carrying out the loop playback

Once setting the Start and End points, you can carry out the loop function.

- Press the [LOOP] key to illuminate the key. The loop function is now active. Each time you press the [LOOP] key, On and Off of the loop function alternates.
- Start playback from the point earlier than the Start point. When the recorder reaches the End point, it automatically locates to the Start point and starts playback from that point. The recorder continues loop playback until stopping the recorder.
- To stop loop playback, press the [LOOP] key to turn off the lamp and press the [STOP] key.

Program

The VF08 can have up to 99 programs (P01 through P99) and usually each program manages one song. You can make recording against each program or playback materials recorded on each program. This section describe program-related operations.

Creating a new program

When formatting a hard disk, a program (P01) is automatically created.

To create a new program, follow the procedure below while the recorder is stopped and the display shows the Normal screen.

<Note>

The initial settings for a new program are copied from the setting of the current program. Therefore, if you want to make a new program with the same settings as an existing program, bring up the program before creating a new program.

- 1 Press the [TRACK EDIT/PGM] key while holding down the [SHIFT] key.

The screen for selecting, renaming or deleting a program appears. (The screen example below shows the initial condition where only Program 01 exists.)



- 2 Use the [JOG] dial to highlight "P02 [New Program]" and then press the [ENTER/YES] key.

When highlighting "P02 [New Program]", only highlighted "SELECT" is shown at the bottom of the screen. Pressing the [ENTER/YES] key creates a new program (P02 in this example) with the tentative title whose leftmost character ("#" in this example) is highlighted. In this condition, you can enter the program title by following the procedure described in "<How to enter a desired title> below.

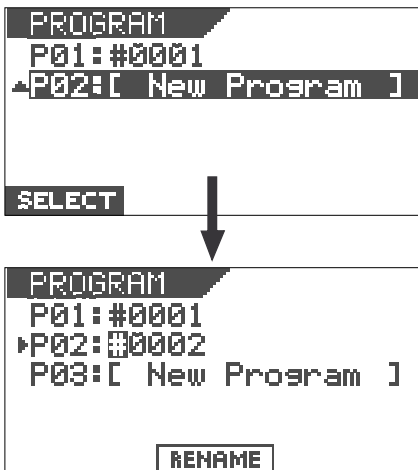

Note that you may use the program with the tentative title ("#0002" in this example) if you do not need to enter the desired one. Anyway, you may also enter/edit the title later by the procedure described in "Editing a program title" on page 57.

To use the program with the tentative title, press the [EXIT/NO] key. To put the desired title, see the following.

<How to enter a desired title>

- Rotate the [JOG] dial (or [CURSOR up/down] keys) to select a character for the blinking point from among those listed below.
- Use the [CURSOR </>] keys to move the blinking point.

```
##%&' ( ) * + , - . / 0 1 2 3 4 5 6 7 8 9 : ;
< = > ? @ A B C D E F G H I J K L M N O P Q R S T
U V W X Y Z [ \ ] ^ _ ` @ a b c d e f g h i j k l m
n o p q r s t u v w x y z { | } + * _ ! " # $ %
```

<Hint>

When selecting a character, rotating the [JOG] dial while holding down the [SHIFT] key jumps among characters surrounded with the box above. This function will allow you to save time for selecting a desired character.

- 3 Press the [ENTER/YES] key after entering the title. The title is set.

- 4 Press the [EXIT/NO] (or [STOP]) key. The setup mode exits and the display shows the Normal screen of the newly created program.

<Hint>

- When creating a new program, the next program number to the highest program number in the existing programs is assigned. If there is only one program (P01), Program 02 (P02) will be created. If there is five programs (P01 through P05), Program 06 (P06) will be created.
- Creating a new program consumes a small amount of the recordable disk space. Also note that when the recordable disk space is not enough, you cannot create a new program.

Selecting a program

When more than one program exists on the disk, you have to select the desired program before starting operations for recording, playback or editing. Select the desired program by following the procedure below while the recorder is stopped and the display shows the Normal screen.

- 1 Press the [TRACK EDIT/PGM] key while holding down the [SHIFT] key. The screen for selecting, renaming or deleting a program appears. In the screen, all existing program numbers and titles are shown.



- 2 Use the [JOG] dial to highlight the desired program and then press the [SETUP/E1] key while holding down the [SHIFT] key.

- 1 Press the [TRACK EDIT/PGM] key while holding down the [SHIFT] key. The screen for selecting, renaming or deleting a program appears. In the screen, all existing program numbers and titles are shown.



- 2 Use the [JOG] dial to highlight the program to be deleted and then press the [UNDO/REDO/F3] key while holding down the [SHIFT] key. The screen shows "Delete! Sure?", asking you confirm.



<Hint>
You may use the [CURSOR >] to highlight "DELETE" and press the [ENTER/YES] key to bring up the screen above, instead of pressing the [UNDO/REDO/F3] key while holding down the [SHIFT] key.

Deleting a program

You can delete an unnecessary program individually. To make recording or editing, a certain amount of disk space is needed. By deleting unnecessary programs, the available disk space increases.

<Notes>

- When only one program (P01) exists, if you try to delete the program, the data in the program is deleted but P01 remains.
- For example, when five programs (P01 through P05) exist, if you delete P03, it looks like P05 is deleted. This is because the program numbers higher than 03 move down. In other words, P04 and P05 become P03 and P04 respectively.

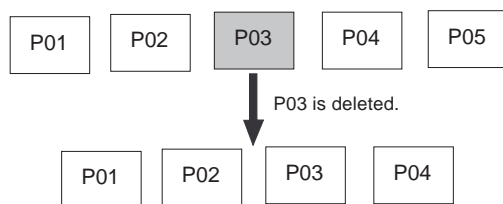

Note that you cannot undo or redo deleting the program.

- 3 Press the [ENTER/YES] key while holding down the [RECORD] key. The selected (highlighted) program is deleted, and the following programs in the list move up.
- 4 Press the [EXIT/NO] key to switch to the Normal screen. The previous program of the deleted program is selected.

Editing a program title

You can edit a program title anytime by following the procedure below. Note that you can also enter a program title in the process of creating a new program as mentioned earlier.

- 1 Press the [TRACK EDIT/PGM] key while holding down the [SHIFT] key. The screen for selecting, renaming or deleting a program appears. In the screen, all existing program numbers and titles are shown.



Recorder Functions

- 2 Use the [JOG] dial to highlight (select) the desired program and then press the [TIME BASE SEL/F2] key while holding down the [SHIFT] key.

Now you can edit the title of the selected program. The leftmost character of the selected program is blinking.

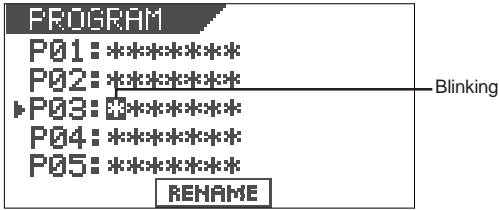

<Hint>

You may use the [CURSOR >] to highlight "RENAME" and press the [ENTER/YES] key to bring up the screen above, instead of pressing the [TIME BASE SEL/F2] key while holding down the [SHIFT] key.

- 3 Use the [CURSOR </>] keys to move the blinking (editing) point and use the [JOG] dial (or [CURSOR up/down] keys) to select a character for the blinking point.

You can put a title name with up to 16 characters from among those listed below.

When selecting a character, rotating the [JOG] dial while holding down the [SHIFT] key jumps among characters surrounded with the box below.

```
##%&'(>)*+,-./0123456789:;
<=>?@ABCDEFGHIJKLMNPOQRSTUVWXYZ
UVWXYZ[^\_`@abcdefghijklmnopqrstuvwxyz
nopqrstuvwxyz{|}~!@#"
```

- 4 Press the [ENTER/YES] key after editing/entering the title. The edited/entered title is set.
- 5 Press the [EXIT/NO] (or [STOP]) key. The display returns to the Normal screen.

Track editing

Because the VF08 uses a 3.5-inch E-IDE hard disk as the recording media, you can make non-linear and non-destructive audio editing by track effectively.

Copy & Paste

The Copy & Paste function allows you to copy track data of a desired part and paste it to a desired part of the same or different track.

The copied data remains after pasting the data, so you can paste the data as many times as required.

The copy & paste function is useful when using the same musical part repeatedly in a song.

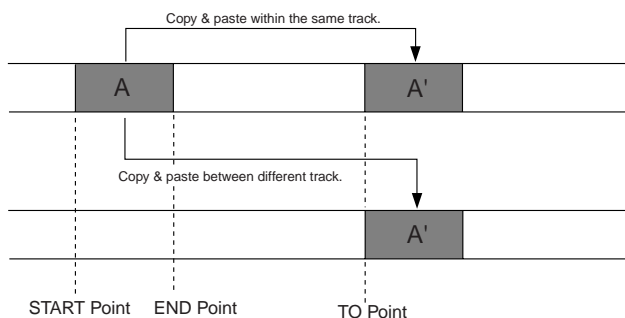

Move & Paste

The Move & Paste function allows you to move track data of a desired part and paste it to a desired part of the same or different track.

Unlike the copy & paste operation, the moved data does not remain in the original position.

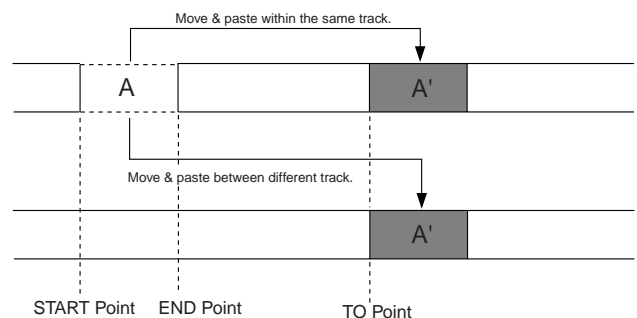

<Notes>

- Copy data (or Move data) is replaced with the new data every time the copy (or move) operation is carried out.
- Note that copy data changes if you paste the copy data to the original data.
- The copy & paste (or move & paste) editing is performed on the current program. Therefore, do not change the current program until the editing operations are completed.

Performing Copy (or Move) & Paste

- 1 Set the Start and End points for the copy (or move) operation and To point for the paste operation. Using the digital scrub function, set the Start, End and To points. See "Storing the digital scrub point" for details about how to set the points.
- 2 While the recorder is stopped, press the [TRACK EDIT] key. The screen for selecting the track edit type appears.

```

TRACK EDIT / CopyPaste
Edit Type Select
Copy Paste
Move Paste
Erase
Exchange
Hit YES or NO Key
  
```

- 3 Use the [JOG] dial to select "Copy Paste" (or "Move Paste") and then press the [ENTER/YES] key. The display shows the screen for selecting the source track(s) and destination track(s).

```

          or "MovePaste"
TRACK EDIT / CopyPaste
Track Select
1 => 1
Hit YES or NO Key
  
```

- 4 Use the [JOG] dial to select the source track(s) from which the data is copied (moved). Rotating the [JOG] dial changes the options among 1 through 8, 1&2, 3&4, 5&6, 7&8, 1-6, and 1-8.
- 5 Use the [CURSOR >] key to highlight (and blink) the right field, and use the [JOG] dial to select the destination track(s) to which the data is copied (moved). Rotating the [JOG] dial changes the options as below depending on the track(s) you selected in step 4.

Source track(s)	Destination options
a mono track (1 through 8)	1 through 8
a pair of tracks	1&2, 3&4, 5&6, and 7&8
1-6	1-6 only
1-8	1-8 only

In the example below, data on tracks 3&4 is copied (or moved) and pasted onto tracks 7&8.

```

TRACK EDIT / CopyPaste
Track Select
3&4 => 7&8
Hit YES or NO Key
  
```

The corresponding [TRACK STATUS/TRACK SEL] keys of the source track(s) light in green, while the corresponding [TRACK STATUS/TRACK SEL] keys of the destination track(s) light in red.

- 6 Press the [ENTER/YES] key after selecting tracks. The display shows the "Point Select" screen as below, in which you can view the Start, End and To points set via the digital scrub operation.

```

TRACK EDIT / CopyPaste
Point Select
Start = **h**m**s**f**
End   = **h**m**s**f**
To    = **h**m**s**f**
Repeat = 01
[ALL OFF] [SRC PLAY] [EXE]
  
```

<Hints>

On the screen above, you can perform the following operations.

1. Editing the Start, End and To points
2. Setting the Start and To points to "ABS 0" and the End point to "REC END"
3. Checking the data to be copied (or moved)
4. Setting the Start, End and To points by marks

• To edit the Start, End and To points:

Highlight the time field of the desired (Start, End or To) point, and then press the [ENTER/YES] key.

The "seconds" value starts blinking, showing that you can edit it. Use the [CURSOR </>] keys to move the blinking value, and use the [JOG] dial to enter a value.

After entering the desired time, pressing the [ENTER/YES] key to store the time data to the point.

• To set the Start and To points to "ABS 0" and the End point to "REC END":

Press the [SETUP/F1] key while holding down the [SHIFT] key. "ALL OFF" changes to "ALL ON", and the Start and To points are set to "ABS 0", while the End point is set to "REC END" point. This function is useful when you copy (or move) all track data (from "ABS 0" to "REC END") to different track(s).

• To check (monitor) the data to be copied (or moved)

[Source Play function]:

Press the [TIME BASE SEL/F2] key while holding down the [SHIFT] key.

The display shows the "Source Play" screen as shown below and the recorder starts playback of the data to be copied (or moved).

```

TRACK EDIT / CopyPaste
Source Play
= **h**m**s**f**
Track = **
[SRC PLAY]
  
```

You can hear audio by moving up the corresponding track fader. After checking audio, press the [STOP] key. The display returns to the screen shown before performing the Source play function.

Recorder Functions

- To set editing points by marks:

Press the [TIME BASE SEL] key.

Each data field for the Start, End and To points changes to show the current option by mark as shown below.

```

TRACK EDIT CopyPaste
Point Select
Start=00:ABS 0
End  =00:ABS 0
To   =00:ABS 0
Repeat= 01
ALL OFF SRC PLAY EXE
    
```

Use the [CURSOR up/down] keys to highlight the field for the desired point, and press the [ENTER/YES] key.

The field starts blinking.

Use the [JOG] dial to select the desired mark and press the [ENTER/YES] key.

The point is set to the selected mark.

<Note>

This operation can be performed only when any mark is set. When no mark is set, "00:ABS 0" is the one and only option for each point.

- 6** Use the [CURSOR down] key to highlight the field ("01" above) for the number of times for repeat paste, and press the [ENTER/YES] key. "01" starts blinking and you can now enter the number of times for repeat paste.

```

TRACK EDIT CopyPaste
Point Select
Start=**h**m**s**f**
End  =**h**m**s**f**
To   =**h**m**s**f**
Repeat= 01
ALL SRC PLAY EXE
    
```

- 7** Use the [JOG] dial to select the desired number and press the [ENTER/YES] key. You can select any number between "01" and "99".

<Note>

Basically you can select the number of times for repeat paste between 1 and 99, however, if the recordable space of the hard disk is limited, you may not be able to select the desired number. The VF08 automatically calculate the available space and limit the number of times to the appropriate value.

When setting the number of times for repeat paste to 02, the copy & paste function is performed as below.

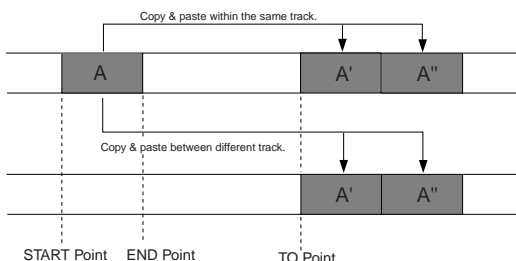

- 8** Press the [UNDO/REDO/F3] key while holding down the [SHIFT] key.

The copy & paste (or move & paste) function is performed. When finished, "Completed!" appears on the screen.

```

TRACK EDIT CopyPaste
Start=**h**m**s**f**
End  =**h**m**s**f**
To   =**h**m**s**f**
Repeat= **
Completed!
EXE
    
```

<Hint>

You may use the [CURSOR >] to highlight "EXE" and press the [ENTER/YES] key to perform the function, instead of pressing the [UNDO/REDO/F3] key while holding down the [SHIFT] key.

<Note>

The copy & paste (or move & paste) operation cannot be performed when there is not enough disk space to perform the undo and redo operations. If you try to perform the paste operation when there is not enough disk space, The display will show "Over Time!", as well as the short time.

In such a case, shorten the copy (or move) data by the amount more than the displayed time or delete unnecessary sections or programs to keep the enough space, and then try to paste again.

Undo/redo of Copy & Paste

You can undo a copy & paste or move & paste operation, as well as redo it (undo the undo operation).

- By pressing the [UNDO/REDO] key after completing the copy & paste (or move & paste) operation, you can return the track(s) to the condition before performing the copy & paste (or move & paste) operation.
- By pressing the [UNDO/REDO] key just after performing the undo operation, you can undo the undo operation and return the track(s) to the condition after performing the copy & paste (or move & paste) operation.

Note the following for performing the undo/redo operation.

<Notes>

You can undo or redo only when the recorder is stopped. If you carry out any of the following after performing the copy & paste (or move & paste) operation, you cannot undo/redo the copy & paste (or move & paste) operation.

1. Making a new recording
2. Performing a new editing
3. Letting the recorder run in playback (or recording) mode and pass through the auto punch-in point while the auto punch mode is active
4. Turning off the power of the VF08
5. Performing any of the program operations (select, rename or delete).

Erasing track data

You can erase a desired part of track data. You can select a track or tracks (of which you are going to erase data) from among each individual track, each pair of tracks, 1-6 and 1-8.

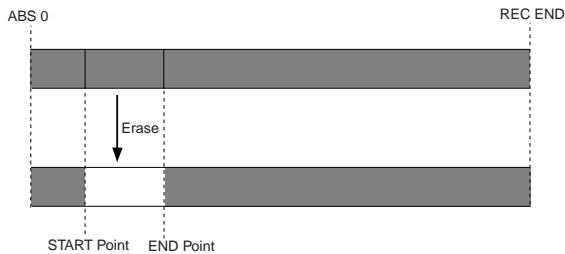

<Notes for the erase function>

- When all eight tracks (1 through 8) are recorded, if you erase a part of the chosen track, only the erased part becomes silent (no audio) and the following material does not move advance to fill the gap. Therefore, the REC END point remains the same. However, if you erase a part between the chosen point (=Start point) and the REC END point (=End point) of all tracks, the REC END point moves advance.
- The erase operations are performed on the current program. Therefore, do not change the current program until all the operations are completed.

Erasing

- 1 Set the Start and End points for the erase operation. Using the digital scrub function, set the Start and End points. See "Storing the digital scrub point" for details about how to set the points.
- 2 While the recorder is stopped, press the [TRACK EDIT] key. The screen for selecting the track edit type appears.

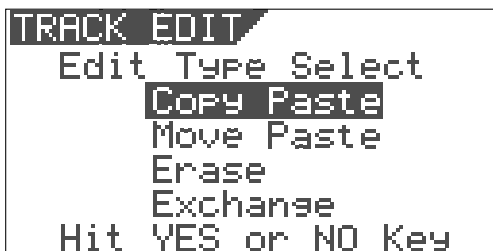

- 3 Use the [JOG] dial to select "Erase" and then press the [ENTER/YES] key. The display shows the screen for selecting the track(s) to be erased.

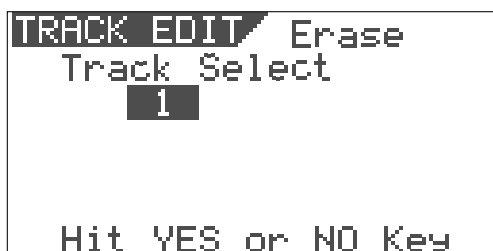

- 4 Use the [JOG] dial to select the track(s) to be erased. Rotating the [JOG] dial changes the options among 1 through 8, 1&2, 3&4, 5&6, 7&8, 1-6, and 1-8. The corresponding [TRACK STATUS/TRACK SEL] key(s) of the selected track(s) light in red.
- 5 Press the [ENTER/YES] key after selecting the track(s). The screen shows the Start and End points.



<Hint>

On the screen above, you can perform the following operations.

1. Editing the Start and End points
2. Setting the Start point to "ABS 0" and the End point to "REC END"
3. Checking the data to be erased
4. Setting the Start and End points by marks

• To edit the Start and End points:

Highlight the time field of a desired (Start or End) point, and then press the [ENTER/YES] key. The "seconds" value starts blinking, showing that you can edit it. Use the [CURSOR </>] keys to move the blinking value, and use the [JOG] dial to enter a value. After entering the desired time, pressing the [ENTER/YES] key to store the time data to the point.

• To set the Start point to "ABS 0" and the End point to "REC END":

Press the [SETUP/F1] key while holding down the [SHIFT] key. "ALL OFF" changes to "ALL ON", and the Start point is set to "ABS 0", while the End point is set to "REC END" point. This function is useful when you erase all track data.

• To check (monitor) the data to be erased [Source Play function]:

Press the [TIME BASE SEL/E2] key while holding down the [SHIFT] key. The display shows the "Source Play" screen as shown below and the recorder starts playback of the data to be erased.

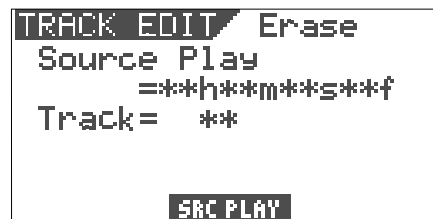

You can hear audio by moving up the corresponding track fader. After checking audio, press the [STOP] key. The display returns to the screen shown before performing the Source play function.

• **To set editing points by marks:**

Press the [TIME BASE SEL] key.

Each data field for the Start and End points changes to show the current option by mark as shown below.

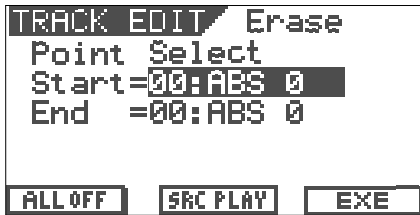

Use the [CURSOR up/down] keys to highlight the field for the desired point, and press the [ENTER/YES] key.

The field starts blinking.

Use the [JOG] dial to select the desired mark and press the [ENTER/YES] key.

The editing point is set to the selected mark.

<Note>

This operation can be performed only when any mark is set. When no mark is set, "00:ABS 0" is the one and only option for each point.

- 6** Press the [UNDO/REDO/F3] key while holding down the [SHIFT] key.

The erase function is performed. When finished, "Completed!" appears on the screen.

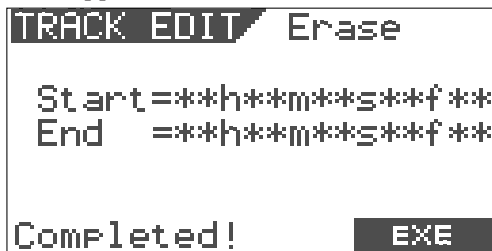

<Hint>

You may use the [CURSOR >] to highlight "EXE" and press the [ENTER/YES] key to perform the function, instead of pressing the [UNDO/REDO/F3] key while holding down the [SHIFT] key.

Undo/redo of Erase

You can undo an erase operation, as well as redo it (undo the undo operation).

- By pressing the [UNDO/REDO] key after completing the erase operation, you can return the track(s) to the condition before performing the erase operation.
- By pressing the [UNDO/REDO] key just after performing the undo operation, you can undo the undo operation and return the track(s) to the condition after performing the erase operation.

Note the following for performing the undo/redo operation.

<Notes>

You can undo or redo only when the recorder is stopped. If you carry out any of the following after performing the erase operation, you cannot undo/redo the erase operation.

1. Making a new recording
2. Performing a new editing
3. Letting the recorder run in playback (or recording) mode and pass through the auto punch-in point while the auto punch mode is active
4. Turning off the power of the VF08
5. Performing any of the program operations (select, rename or delete).

Track Exchange

The track exchange function allows you to exchange tracks (regardless of whether they are real or additional tracks) on the program in single track unit, 2-track unit or 8-track unit.

By using this function, you can exchange tracks not only among real tracks but also between real and additional tracks, allowing to use tracks effectively. For example, by exchanging a recorded real track with an empty additional track, you can transfer data on a real track to an additional track temporarily, so that you can record a new material onto the real track. The track exchange function is also used to check the REC END point on an additional track.

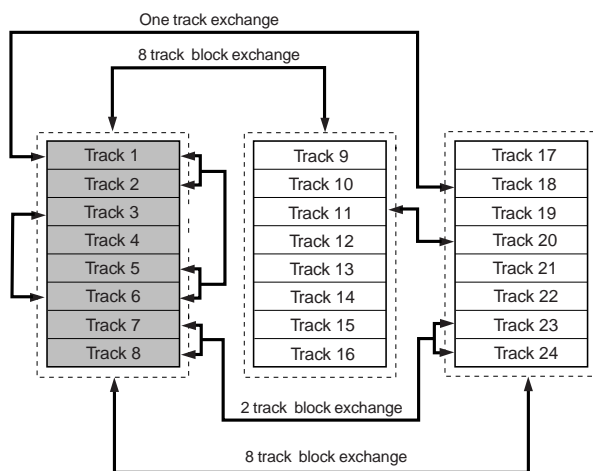

Performing the track exchange

- 1 While the recorder is stopped, press the [TRACK EDIT] key.

The screen for selecting the track edit type appears.

```

TRACK EDIT /
Edit Type Select
Copy Paste
Move Paste
Erase
Exchange
Hit YES or NO Key
  
```

- 2 Use the [JOG] dial to select "Exchange" and then press the [ENTER/YES] key.

The display shows the screen for selecting the tracks to be exchanged. The screen example below shows that tracks 01 through 08 and tracks 17 through 24 are exchanged in 8-track unit.

The left field shows the source track(s), while the right fields shows the destination track(s).

```

TRACK EDIT / Exchange
Track Select
01-08<=>17-24
Hit YES or NO key
  
```

- 3 Use the [JOG] dial to select the source track(s). Rotating the [JOG] dial changes the options among single tracks (1 through 24), pair tracks (1&2 through 23&24), 1-8, 9-16 and 17-24.
- 4 Use the [CURSOR >] key to highlight (and blink) the right field, and use the [JOG] dial to select the destination track(s). You can only select the same number of tracks as the source track(s) selected in step 3 above. For example, if you select a single track in step 3 above, you can only select a single track here.

<Example 1> Exchanging Track 8 and Track 24

```

TRACK EDIT / Exchange
Track Select
08 <=> 24
Hit YES or NO key
  
```

<Example 2> Exchanging Tracks 1&2 and Tracks 7&8

```

TRACK EDIT / Exchange
Track Select
01&02<=>07&08
Hit YES or NO key
  
```

<Example 3> Exchanging Tracks 1-8 and Tracks 17-24

```

TRACK EDIT / Exchange
Track Select
01-08<=>17-24
Hit YES or NO key
  
```

- 5 After selecting tracks, press the [ENTER/YES] key. The track exchange function is performed and the display returns to the Normal screen.

<Note for Track Exchange>

If the selected tracks for the left and right fields are reversed, the same track exchange is performed.

For example, "1-8<->17-24" and "17-24<->1-8" perform the same track exchange.

The setting in which the same track(s) are selected for both the left and right fields, such as "1-8<->1-8", is invalid. If you press the [ENTER/YES] key with such a setting, the display shows the message "Select Err! Hit Any Keys".

Editing Marks

This section describes how to edit marks, assuming that more than one mark is already stored in realtime according to the operations described in "Chapter 2 Basic Recording and Playback".

Viewing the mark list

You can view the marks stored.

- 1 While the recorder is stopped, press the [SCENE SEQ./MAP] key while holding down the [SHIFT] key. The mark positions are shown by time or bar/beat/clock values depending on the time base (In the following screen example, the time base is set to "Bar/Beat/Clk").

MARK MAP	BAR/	BEAT/	CLK
00:-02BAR	1/00		S00
01:012BAR	1/00		Non
02:020BAR	4/30		Non
*03:028BAR	6/46		Non
04:022BAR	2/30		Non
LOCATE EDIT DELETE			

- 2 Use the [JOG] dial or [CURSOR up/down] keys to scroll the marks stored. In the Mark map screen, you can not only view all the marks but also perform various operations (such as editing a mark position, entering a mark title, locating a mark, deleting a mark and adding a mark) described later.

<Hint>

When the Mark map screen is shown, you can switch the screen to display the position (by time or bar/beat/clock) or title of each mark by pressing the [TIME BASE SEL] key.

- 3 After viewing the list, press the [EXIT/NO] key. The display returns to the Normal screen.

Editing a mark position

You can edit the current position of a mark in the mark map.

- 1 While the recorder is stopped, press the [SCENE SEQ./MAP] key while holding down the [SHIFT] key. The Mark map screen appears.

MARK MAP	BAR/	BEAT/	CLK
00:-02BAR	1/00		S00
01:012BAR	1/00		Non
02:020BAR	4/30		Non
*03:028BAR	6/46		Non
04:022BAR	2/30		Non
LOCATE EDIT DELETE			

- 2 Use the [JOG] dial or [CURSOR up/down] keys to highlight the desired mark, and then press the [TIME BASE SEL/F2] key. The display shows the screen for editing the chosen mark.

MARK MAP	MARK03	Edit
Blinking	028BAR	6/46CLK
Name = ABS 0		
Scene = Non		
Hit ENTER or EXIT		

- 3 Use the [CURSOR </>] keys to highlight (and blink) the field you want to edit, and then use the [JOG] dial to select the desired value. When the time base is set to "ABS" or "MTC", you can edit fields for minute, second, frame and subframe. When the time base is set to "Bar/Beat/Clk", you can edit fields for bar, beat and clock, as shown below.]

MARK MAP	MARK03	Edit
	028BAR	6/46CLK

- 4 After editing time (or bar/beat/clock), press the [ENTER/YES] key. The edited value is stored to the mark and the display returns to the Mark map screen.
- 5 Press the [EXIT/NO] key. The display returns to the Normal screen.

Enter a mark title

You can enter or edit a title for each mark.

- 1 While the recorder is stopped, press the [SCENE SEQ./MAP] key while holding down the [SHIFT] key. The Mark map screen appears.



- 2 Use the [JOG] dial or [CURSOR up/down] keys to highlight the desired mark, and then press the [TIME BASE SEL/F2] key. The display shows the screen for editing the chosen mark.

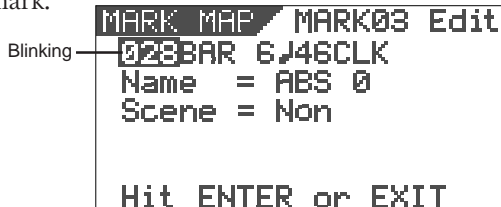

- 3 Press the [CURSOR </>] keys repeatedly to highlight (and blink) the leftmost point of the title field.

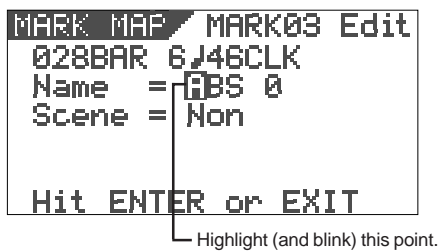

- 4 Use the [CURSOR </>] keys to move the highlighted point among the title field, and use the [JOG] dial to select the desired character.

You can use up to 14 characters for each title but because of the screen size, characters displayed at once are limited. You can select a character from among the following.

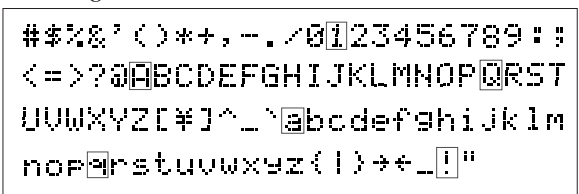

Hint
When selecting a character, rotating the [JOG] dial while holding down the [SHIFT] key jumps among characters surrounded with the box above.

- 5 After entering/editing the title, press the [ENTER/YES] key. The entered/edited title is stored to the mark.
- 6 Press the [EXIT/NO] key. The display returns to the Normal screen.

Adding a mark

You can add a mark to the mark map.

- 1 While the recorder is stopped, press the [SCENE SEQ./MAP] key while holding down the [SHIFT] key. The Mark map screen appears.



- 2 Use the [JOG] dial or [CURSOR up/down] keys to highlight "New Mark", and then press the [TIME BASE SEL/F2] key. You can find "[New Mark]" at the bottom of the mark map.

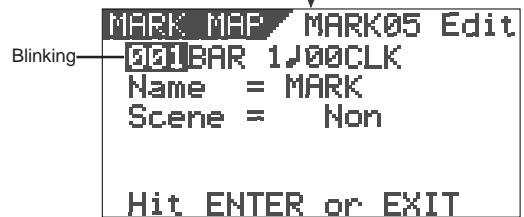

On the screen for editing the mark, "001" (Bar number field) is blinking, showing that it can be edited. The mark name is tentatively set to "Mark", while no scene is assigned (indicated by "Non").

- 3 Use the [CURSOR </>] keys to highlight (and blink) the field you want to edit among BAR, BEAT and CLK, and then use the [JOG] dial to select the desired value. When setting the time base to ABS or MTC, you can set the position in the similar way.
- 4 After setting the mark position, press the [ENTER/YES] key. The new mark is added to the mark map and the display returns to the Mark map screen.
- 5 Press the [EXIT/NO] key. The display returns to the Normal screen.

<Hint>
When adding a new mark, you can also enter a mark title or assign a scene for the scene sequence function. See "Enter a mark title" above and "Scene Memory" in "Mixer Functions" for details about operations.

Recorder Functions

Deleting a mark

You can delete an unnecessary mark.

- 1 While the recorder is stopped, press the [SCENE SEQ./MAP] key while holding down the [SHIFT] key. The Mark map screen appears.

MARK MAP	BAR	BAR
00: -02BAR	1/00	S00
01: 012BAR	1/00	Non
02: 020BAR	4/30	Non
03: 028BAR	6/46	Non
04: 022BAR	2/30	Non

LOCATE EDIT DELETE

- 2 Use the [JOG] dial or [CURSOR up/down] keys to highlight the mark you want to delete, and then press the [UNDO/REDO/F3] key while holding down the [SHIFT] key. "Delete!" is shown and "Sure?" blinks. To cancel the delete operation, press the [EXIT/NO] key.

MARK MAP	BAR	BAR
00: 00000	1/00	S00

03: 028BAR	6/46	
Delete! Sure?		
** REC+YES or NO **		

LOCATE EDIT DELETE

Blinking

- 3 Press the [ENTER/YES] key while holding down the [RECORD] key. The chosen mark is deleted and the mark map is sorted, resulting marks following the deleted mark in the mark map list move up. For example, if you delete Mark 03, the current Mark 04, 05,... will replace Mark 03, 04,... respectively.
- 4 Press the [EXIT/NO] key. The display returns to the Normal screen.

Locating a mark

You can directly locate a mark.

- 1 While the recorder is stopped, press the [SCENE SEQ./MAP] key while holding down the [SHIFT] key. The Mark map screen appears.

MARK MAP	BAR	BAR
00: -02BAR	1/00	S00
01: 012BAR	1/00	Non
02: 020BAR	4/30	Non
03: 028BAR	6/46	Non
04: 022BAR	2/30	Non

LOCATE EDIT DELETE

- 2 Use the [JOG] dial or [CURSOR up/down] keys to highlight the mark you want to locate, and then press the [SETUP/F1] key while holding down the [SHIFT] key. The recorder locates to the selected mark, and the display returns to the Normal screen.

<Hint>

If you press the [SETUP/F1] key while holding down the [SHIFT] key after editing a mark position (see "Editing a mark position"), you can locate the new mark position.

Advanced Operation

This chapter describes advanced or useful functions of the VF08.

Metronome function

The VF08 provides the internal tempo map, in which you can set the time signature (e.g. 4/4, 3/4) and tempo (between 30 and 250).

It also can output the metronome sound (click) according to the tempo map, allowing you to record materials at the specific tempo without the need of an external metronome or rhythm machine.

The metronome sound can be output from Track 6 of the VF08 when you set "Click?" in the Setup menu to "On."

<Note>

When Track 6 is set to output the metronome sound (i.e. when you set "Click?" menu in the Setup menu to "On"), you cannot record audio on Track 6 or playback audio recorded on Track 6.

When you have finished using the metronome function, we recommend setting "Click?" menu in the Setup mode to "Off" so that you can use Track 6 for recording and playback.

Setting the tempo map

To output the metronome sound (click), the tempo map must be set.

To set the tempo map, use "Signature Set" and "Tempo Set" menus in the Setup mode.

Initially, the time signature is set to "4/4" while the tempo is set to "120."

To change the initial settings, operate the following.

- 1 While the VF08 is stopped, press the [SETUP] key to enter the Setup mode.
The screen for selecting a menu in the Setup mode appears.
- 2 Use the [JOG] dial to select the "Signature Set" menu, and then press the [ENTER/YES] key.
The screen for setting the time signature appears.
Set the desired time signature according to the procedure described in "Setting the time signature" on page 99.
- 3 After setting the time signature, press the [EXIT/NO] key to return to the screen for selecting a menu in the Setup mode.
- 4 Use the [JOG] dial to select the "Tempo Set" menu, and then press the [ENTER/YES] key.
The screen for setting the tempo appears.
Set the desired tempo according to the procedure described in "Setting the tempo" on page 101.
- 5 After setting the tempo, press the [EXIT/NO] key to return to the screen for selecting a menu in the Setup mode.
Go on to set the metronome output described below.

Setting the metronome output

You can set whether outputting the metronome sound or not by "Click?" menu in the Setup mode.

- 1 Use the [JOG] dial to select the "Click?" menu, and then press the [ENTER/YES] key.
The initial setting is "Off."
- 2 Use the [JOG] dial to select "On", and then press the [ENTER/YES] key.
Now the metronome sound will be output from Track 6.
- 3 Press the [EXIT/NO] key repeatedly until exiting the Setup mode.

Setting the time base to bar/beat

- 1 Press the [TIME BASE SEL] key to set the time base to "Bar/Beat."
When the time base is set to "Bar/Beat", you can monitor the current position by Bar/Beat according to the tempo map you set.

Monitoring the metronome sound

- 1 Press the [PLAY] key to start playback of the VF08.
The level meter for Track 6 shows the metronome sound level.
Set the Master and Track 6 faders to the "0" position, and raise the [PHONES] knob to monitor the metronome sound via the headphones.

You can now record a material while listening to the metronome sound as a guide.

Track bounce (Ping-pong recording)

When the number of empty tracks is short in the recording process, you can solve the problem by transferring audio on the multiple already-recorded tracks to a different track or tracks.

This operation is called "Track bounce" or "Ping-pong recording". With the VF08, you can do this operation simply by using the [BOUNCE MODE] key.

When the Bounce mode is active, Tracks 7/8 are automatically armed and the materials recorded on Tracks 1 through 6 are ready to be bounced to Tracks 7/8.

In the following description for track bouncing operation, we assume that mono materials are recorded on Tracks 1 through 4, while a stereo material is recorded on Tracks 5 and 6.

On/off of bounce mode

- 1 Press the [BOUNCE MODE] key.
Each press of the key alternates "On" and "Off."
When set to "On", the key is illuminated, while the Bounce screen appears where "Remain" is displayed.



Tracks 7/8 are automatically armed and the corresponding [TRACK STATUS/TRACK SEL] key flashes in red.

When the Bounce mode is active, you cannot arm the other tracks (1 through 6).

<Note>

If the peak indicator lights up, the recorded sound will be distorted. Adjust the playback level of each track appropriately.

You can see the playback levels on Tracks 1 through 6, input levels on Track 7/8 and output levels of the Stereo busses (L and R) via the meters on the screen.

By raising the [PHONES] knob, you can monitor the sound.



- 4 After adjusting the levels, stop the recorder and then locate the beginning position of track bouncing.

Setting pan positions

- 1 Press the [PAN] key to set the pan position for each track.
Set the pan positions at the desired points for Tracks 1 through 4, fully left for Track 5 and fully right for Track 6. See "Mixer Functions" for details about the pan setting.
- 2 After setting all pan positions, press the [EXIT/NO] key.
The balance mode screen appears.

Setting level of each track

- 1 Set the [MASTER] fader to the "0" position.
- 2 Press the [RECORD] key only.
The [RECORD] key starts flashing, while Tracks 7/8 enter the input monitor mode.
- 3 Press the [PLAY] key to start playback and adjust playback levels of Tracks 1 through 6 using the track faders.
Be careful not to light up the peak indicator when adjusting the playback level of each track.

Performing the track bounce

- 1 Press the [PLAY] key while holding down the [RECORD] key to start track bouncing.
The recorder starts recording of mixed audio from Tracks 1 through 6 to Tracks 7/8.
- 2 After finishing the track bounce, press the [STOP] key to stop the recorder.
Now you can use Tracks 1 through 6 to record new materials.

<Note>

You can also apply EQ and/or effects to audio signals on Tracks 1 through 6 to be bounce to Track 7/8. See "Mixer Function" for details about how to apply EQ and effects.

Training mode

The VF08 provides the training mode which allows you to practice your instrument while playing back only Tracks 7/8. In the training mode, you can slow down the playback speed or altering the pitch, making it easy to play along with your favorite musicians or transcribing ad-lib phrases.

You can also cancel the vocal or lead guitar solo which is positioned in the center, allowing you to replace it with your vocal or guitar (like a karaoke).

The following description shows how to play the guitar along with audio recorded on Tracks 7/8.

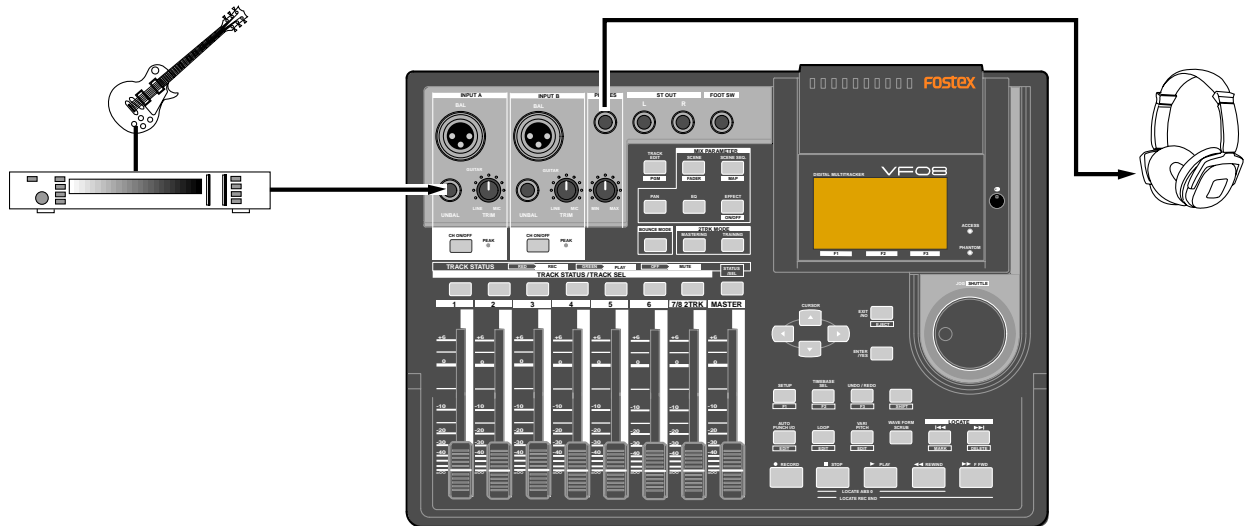

<Hint>

Because only Tracks 7/8 can be played back in the Training mode, you have to record a song used for your practice in advance.

If you are going to use a song recorded on other tracks, it will be a good idea to use the track exchange function to move the song to Tracks 7/8.

Also, when you want to use an external source on CD, MD, etc., record it onto Tracks 7/8 digitally using the technique described later in "Digital Recording."

<Caution>

When copying a copyright material from CD, MD, etc., do not use the copy for any purpose except your practice or enjoyment. Any unauthorized use of the copy for commercial purpose will constitute infringement of such copyright and will render the infringer liable to an action at law.

<Note>

When the training mode is active, you cannot make any recording, as well as playback Tracks 1 through 6.

Connecting the instrument and headphones

- 1 Set the [MASTER] fader to the "∞" position.
- 2 Connect the instrument and headphones as shown in the illustration above.
You may connect the instrument either [INPUT A] or [INPUT B].

On/Off of training mode

- 1 Press the [TRAINING] key.
Each press of the key alternates "ON" and "OFF." When set to "ON", the [TRAINING] key is illuminated, while the display shows the training mode screen.

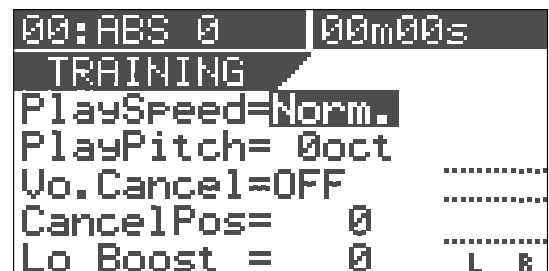

On the training mode screen, you can set the following. You can use the [CURSOR up/down] key to select (highlight) the item to be set.

1. Playback speed
2. Playback pitch
3. On/Off of the center cancel function
4. Setting of the cancel position
5. Low boost setting (for emphasizing the bass sound)

<Note>

You can set the playback speed only while the VF08 is stopped. The other items can be set both while stopped and during playback.

Slowing down the playback speed

You can change the playback speed only while the recorder is stopped.

- 1 When "Norm" in the "Play Speed" field is highlighted, use the [JOG] dial to select "Half."
The playback speed is set to half the normal speed and the pitch automatically raises one octave.
To change only the pitch, see the next section.

```
00:ABS 0 | 00m00s
TRAINING
PlaySpeed=Half
PlayPitch=+1oct
Vo.Cancel=OFF .....
CancelPos= 0 .....
Lo Boost = 0 L R
```

- 2 To return to the normal speed, use the [JOG] dial to select "Norm."
The playback speed returns to the normal speed.

Changing the pitch

The following items can be set both while stopped and during playback.

- 1 Using the [CURSOR down] key to highlight the "Play Pitch" field, and then use the [JOG] dial to select the desired pitch.
You can set the pitch within the range of +/- one octave.

```
00:ABS 0 | 00m00s
TRAINING
PlaySpeed=Norm.
PlayPitch= 0oct
Vo.Cancel=OFF .....
CancelPos= 0 .....
Lo Boost = 0 L R
```

Canceling the center-positioned sound

- 1 Using the [CURSOR down] key to highlight the "Vo. Cancel" field, and then use the [JOG] dial to select "ON".
You can cancel the center-positioned sound such as a lead vocal.
Depending on audio sources, you may not perfectly cancel the sound you want to remove because it is not exactly center-positioned. In such a case, perform the next operation.

```
00:ABS 0 | 00m00s
TRAINING
PlaySpeed=Norm.
PlayPitch= 0oct
Vo.Cancel=OFF .....
CancelPos= 0 .....
Lo Boost = 0 L R
```

Setting the cancel position

- 1 Using the [CURSOR down] key to highlight the "Cancel Pos" field, and then use the [JOG] dial to set the desired value.
You can select the cancel position from "-99" via "0" to "+99" in one step increments.
Try to find the best position where the sound to be cancel gets lowest.

```
00:ABS 0 | 00m00s
TRAINING
PlaySpeed=Norm.
PlayPitch= 0oct
Vo.Cancel=OFF .....
CancelPos= 0 .....
Lo Boost = 0 L R
```

Boosting the bass sound

- 1 Using the [CURSOR down] key to highlight the "Lo Boost" field, and then use the [JOG] dial to set the desired value.
You can select the low boost level from "0" to "10" in one step increments.

```
00:ABS 0 | 00m00s
TRAINING
PlaySpeed=Norm.
PlayPitch= 0oct
Vo.Cancel=OFF .....
CancelPos= 0 .....
Lo Boost = 0 L R
```

Playing along with the playback sound

- 1 Set the [MASTER] fader to the "0" position.
- 2 Press the [PLAY] key to starts playback of the VF08 and raise the Track 7/8 fader gradually.
You can see the level is going up via the stereo output level meters (L and R) on the screen.
Rotate the [PHONES] knob to adjust the headphones level.
- 3 Play the guitar along with the playback sound of Tracks 7/8, while adjusting the [TRIM] knob to the appropriate position where the [PEAK] indicator for the input you connect the guitar does not light.
You can hear both the playback sound of Tracks 7/8 and your guitar together from the headphones.
If you move down the Tracks 7/8 fader, you can only hear your guitar.

Mastering mode

You can use Tracks 7/8 as the mastering tracks.

After performing the track bouncing to mix down track signals to Tracks 7/8, you can record the audio signals on Tracks 7/8 to an external (analog or digital) master recorder with applying effects for mastering (see the illustration below).

You can perform the above operation in the mastering mode, which can be selected by the [MASTERING] key. When the mastering mode is active, only Tracks 7/8 can be played back, while the dedicated effects for mastering are available. In the following description, we assume that the stereo mix signals are recorded on Tracks 7/8.

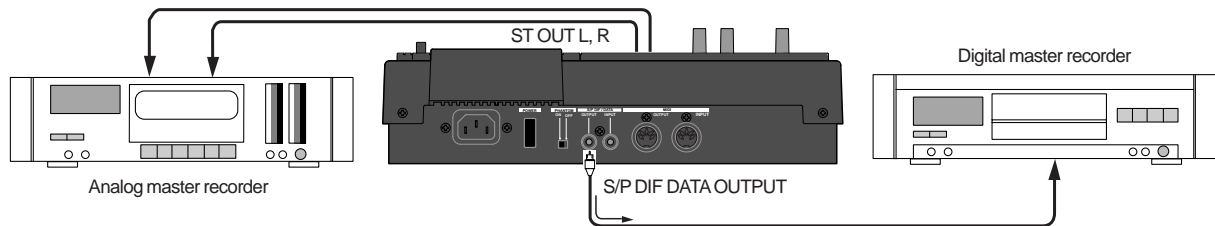

Selecting a program to be played back

If there are more than one program in the VF08, select the desired program to be played back. See "Selecting a program" for the operation.

On/off of mastering mode

- 1 Press the [MASTERING] key. Each press of the [MASTERING] key alternates ON and OFF of the mastering mode.

When setting to ON, the [MASTERING] key is illuminated and the following screen is displayed, while the [TRACK STATUS/TRACK SEL] key of Track 7/8 and the [STATUS/SEL] key for the master are illuminated in green.

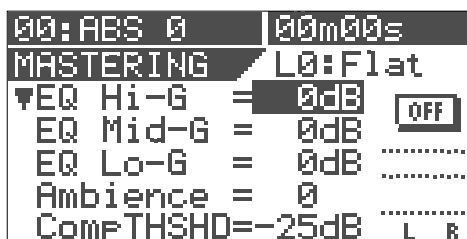

The screen example above shows the upper part of the mastering effects setting. Pressing the [CURSOR down] key scrolls down the setting items. To scroll up, press the [CURSOR up] key.

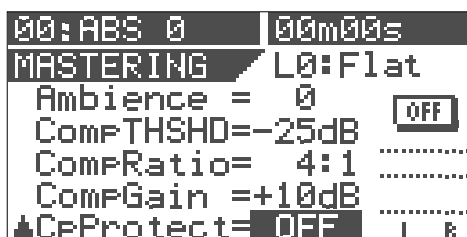

The table below shows the items and functions of the mastering effects.

Effect library		You can select a desired preset entry from 10 entries stored in the effect library. See "Effect library details" on the next page.
EQ	High Gain	Adjusts the EQ gain for the high frequency range within a +/- 18 dB range. Freq. and Q: fixed
	Mid Gain	Adjusts the EQ gain for the middle frequency range within a +/- 18 dB range. Freq. and Q: fixed
	Low Gain	Adjusts the EQ gain for the low frequency range within a +/- 18 dB range. Freq. and Q: fixed
Ambience	Rev Level	Adjusts the amount of reverb sound between 0 and 99.
	Rev Time	Fixed (See "Effect library details" on the next page.)
	Pre Delay	
Compressor	Threshold	Adjusts the threshold of the compressor between -50 dB and 0 dB in 1 dB steps.
	Ratio	Selects the compressor ratio from the following options. ∞:1, 20:1, 10:1, 8:1, 6:1, 5:1, 4:1, 3.5:1, 3:1, 2.5:1, 2:1, 1.7:1, 1.5:1, 1.3:1, 1.1:1, 1:1
	Gain	Adjusts the compressor gain between 0 dB and +18 dB.
	Attack	Fixed (See "Effect library details" on the next page.)
Copy Protect		Selects ON or OFF of the copy protection for the S/P DIF output signal. When set to ON, the flag for limiting a digital copy to one generation is set in the S/P DIF digital output signal.

Advanced Operation

<Hint>

When selecting a desired preset entry from the effect library, the initial parameter values of the entry are shown on the screen.

See "Effect library details" on the next page for the detailed information.

Setting the mastering effects

- 1 Set the [MASTER] fader at the "0" position.
- 2 Start playback and move up the Track 7/8 fader gradually.
You can monitor the playback sound of Tracks 7/8 by rotating the [PHONES] knob clockwise.
In the mastering mode, you cannot monitor the playback sound of other tracks even if you move up the faders.
- 3 Use the [CURSOR up/down] key to highlight the parameter value to be edited, and use the [JOG] dial to select the desired value.
You can monitor the tailored sound of Tracks 7/8 in realtime.

<Hint>

When any parameter value is changed from the initial setting, "E" appears on the right of the preset entry name (as shown below), showing that the current setting is different from the initial setting.

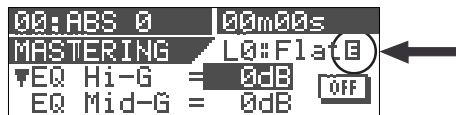

On/off of the mastering effects

- 1 To switch on or off the mastering effects, use the [CURSOR up/down] key to highlight the ON/OFF icon as shown below, and use the [JOG] dial to select "ON" or "OFF".

When "ON" is selected, effected "wet" sound is output.
When "OFF" is selected, "dry" sound is output.



Recording onto the master recorder

- 1 Stand by the master recorder for recording, and start playback of the VF08.
You have to adjust the recording level now.
When the recording signal is digitally transferred from the VF08 to the recorder, because a digital recorder usually does not provide the function for controlling the digital input level, you must adjust the recording level by controlling the stereo output level of the VF08 using the [MASTER] fader.

- 2 After setting the recording level, return the VF08 to the beginning of the program.
- 3 Start recording of the master recorder and then start playback of the VF08.
The stereo output (L and R) signals are recorded onto the master recorder.
- 4 After finishing recording, stop the both machines.

<Hint>

When you record VF08 audio onto a digital master recorder via the S/P DIF digital signal, if the copy protection ("Cp Protect") is set to "ON", you can limit the digital copy from the master to another recorder.
If you do not want to make digital copies freely from the master, set the copy protection to "ON."

Effect library details

The master effect library provides 10 preset entries which can only be used in the mastering mode.

When applying mastering effects to the sound, you can use a desired preset as a starting point of your effect setting.

The following table shows the initial settings of EQ, reverb and compressor parameters, as well as the major usage for each preset.

L0: FLAT

	Gain	Freq. (fixed)	Q (fixed)
EQ Lo	0	400Hz	L-S
EQ Mid	0	1kHz	1
EQ Hi	0	4kHz	H-S
Ambience	0 (Rev Level)		
Rev Time=1.0s / Pre Dly=0ms : fixed			
Comp THSHD	-25		
Comp Ratio	4 : 1		
Comp Gain	+10		
Attack Time = 8ms : fixed			

<Comment>

Basic mastering effects.
Can be used for a wide range of music genre.

L1: Wet Mix

	Gain	Freq. (fixed)	Q (fixed)
EQ Lo	0	400Hz	L-S
EQ Mid	0	1kHz	1.0
EQ Hi	+4.0	8kHz	H-S
Ambience	75 (Rev Level)		
Rev Time=0.5s / Pre Dly=0ms : fixed			
Comp THSHD	-30		
Comp Ratio	3 : 1		
Comp Gain	+10		
Attack Time = 5ms : fixed			

<Comment>

Makes a dry sound wet.

L2: Light Mix

<Comment>
Makes a dark sound bright.

	Gain	Freq. (fixed)	Q (fixed)
EQ Lo	0	400Hz	L-S
EQ Mid	0	1kHz	1.0
EQ Hi	+4.0	8kHz	H-S
Ambience	0 (Rev Level)		
Rev Time=1.0s / Pre Dly=0ms : fixed			
Comp THSHD	-42		
Comp Ratio	3 : 1		
Comp Gain	+18		
Attack Time = 10ms : fixed			

L6: Hard

<Comment>
Powerful sound.

	Gain	Freq. (fixed)	Q (fixed)
EQ Lo	0	400Hz	L-S
EQ Mid	0	1kHz	1
EQ Hi	0	4kHz	H-S
Ambience	0 (Rev Level)		
Rev Time=1.0s / Pre Dly=0ms : fixed			
Comp THSHD	-36		
Comp Ratio	8 : 1		
Comp Gain	+18		
Attack Time = 5ms : fixed			

L3: Live Mix

<Comment>
Makes a sound like recorded in a small live house.

	Gain	Freq. (fixed)	Q (fixed)
EQ Lo	0	400Hz	L-S
EQ Mid	0	1kHz	1.0
EQ Hi	-18	8kHz	H-S
Ambience	99 (Rev Level)		
Rev Time=0.1s / Pre Dly=30ms : fixed			
Comp THSHD	-20		
Comp Ratio	1.5 : 1		
Comp Gain	+8		
Attack Time = 5ms : fixed			

L7: 70s

<Comment>
Soulful and energetic sound of 70s'.

	Gain	Freq. (fixed)	Q (fixed)
EQ Lo	-6	400Hz	L-S
EQ Mid	0	1kHz	1
EQ Hi	LPF-ON	6kHz	LPF
Ambience	0 (Rev Level)		
Rev Time=1.0s / Pre Dly=0ms : fixed			
Comp THSHD	-10		
Comp Ratio	5 : 1		
Comp Gain	+2		
Attack Time = 5ms : fixed			

L4: Pop Mix

<Comment>
Suitable for typical pop music with vocal.

	Gain	Freq. (fixed)	Q (fixed)
EQ Lo	-3	400Hz	L-S
EQ Mid	-3	500Hz	2.0
EQ Hi	+2	4kHz	H-S
Ambience	80 (Rev Level)		
Rev Time=0.7s / Pre Dly=0ms : fixed			
Comp THSHD	-36		
Comp Ratio	3.5 : 1		
Comp Gain	+18		
Attack Time = 10ms : fixed			

L8: Hall

<Comment>
Makes a sound like recorded in a concert hall.

	Gain	Freq. (fixed)	Q (fixed)
EQ Lo	+4	400Hz	L-S
EQ Mid	-4	500Hz	1
EQ Hi	-8	6kHz	H-S
Ambience	80 (Rev Level)		
Rev Time=3.0s / Pre Dly=100ms : fixed			
Comp THSHD	-25		
Comp Ratio	1.5 : 1		
Comp Gain	+5		
Attack Time = 8ms : fixed			

L5: Dance

<Comment>
Suitable for a dancing floor. A speedy sound which makes an audience excite.

	Gain	Freq. (fixed)	Q (fixed)
EQ Lo	+10	400Hz	L-S
EQ Mid	-18	550Hz	3.5
EQ Hi	+15	10kHz	3.5
Ambience	0 (Rev Level)		
Rev Time=1.0s / Pre Dly=0ms : fixed			
Comp THSHD	-30		
Comp Ratio	5 : 1		
Comp Gain	+14		
Attack Time = 5ms : fixed			

L9: LO_Fi

<Comment>
Narrow range sound by limiting the frequency range drastically.

	Gain	Freq. (fixed)	Q (fixed)
EQ Lo	-18	400Hz	L-S
EQ Mid	+15	2kHz	1
EQ Hi	LPF-ON	2kHz	LPF
Ambience	0 (Rev Level)		
Rev Time=1.0s / Pre Dly=0ms : fixed			
Comp THSHD	-25		
Comp Ratio	∞ : 1		
Comp Gain	+5		
Attack Time = 5ms : fixed			

Digital recording

You can digitally record an external digital source to the VF08, or stereo output signals of the VF08 to an external digital recorder. This section describes how to make digital recording between the VF08 and an external digital device. Note that the VF08 can only handle S/P DIF format digital data.

Recording an external source onto the VF08 digitally

The following describes how to record an external S/P DIF digital source (such as CD, MD and DAT) onto the VF08.

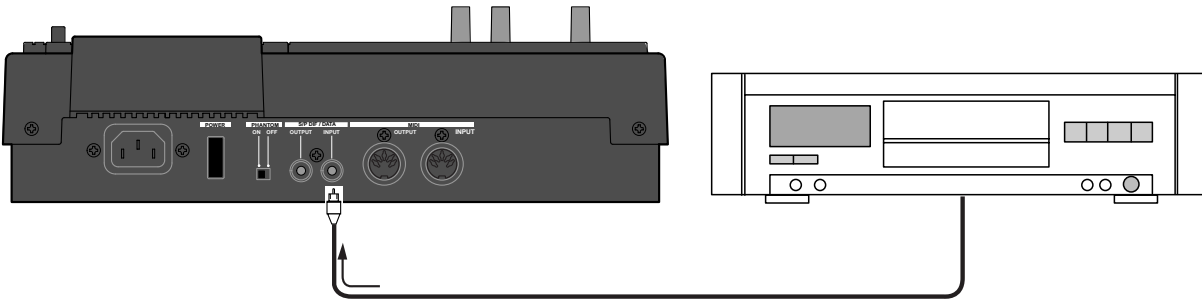

<Important note>

* When recording a digital source onto the VF08, make sure that the source signal is the "44.1 kHz, 16-bit" S/P DIF digital format.

* You can record an external S/P DIF digital source only onto Tracks 7/8 of the VF08. If you want to record it onto other tracks, first record it onto Tracks 7/8 and then move the data to other tracks using the track exchange function.

Selecting a program to be recorded

When more than one program exists, select the desired program using the program select function before recording.

See "Selecting a program" in "Recorder function" about how to select a program.

Selecting the digital input

- 1 In the "Digital In" menu of the setup mode, select "On." See "Setting digital input" in "Setup mode" about how to select "On."
When set to "On", you can record an incoming S/P DIF signal from the [S/P DIF / DATA INPUT] connector onto Track 7/8 of the VF08.

- 2 After setting "Digital In" menu, press the [EXIT/NO] key to exit the setup mode.
When receiving a correct S/P DIF digital signal, "DIGI IN" is shown steadily on the screen. When a correct digital signal is not received, "DIGI IN" blinks on the screen. In such a case, check the connection and settings of the external source device.

Selecting a track to record

- 1 Press the [TRACK STATUS/TRACK SEL] key of Tracks 7/8.
The key lighting in green change to flashing in red.

Starting to record

- 1 Set the Track 7/8 and Master faders to the "0" position.
- 2 Start recording of the VF08 by pressing the [PLAY] key while holding down the [RECORD] key, and start playback of the external digital device.
"When recording a digital signal, you cannot adjust the input level of the VF08." "To get the optimum recording level, adjust the output level of the source."
The level meters for Tracks 7/8 on the screen shows the input levels.

<Note>

During digital recording, the level meters for the stereo outputs (L and R) are not active.

- 3 Rotating the [PHONES] knob clockwise to monitor the source sound.
- 4 After finishing recording, stop the VF08 by pressing the [STOP] key, as well as stop the external digital device.

<Note>

After you have finished the digital recording, return the "Digital In" setting to "Off."
When "On", you cannot record any analog signal onto Tracks 7/8.

Recording the VF08 stereo output signals digitally onto an external digital device

You can record the stereo output signal digitally onto an external digital device via the [S/P DIF/DATA OUTPUT] connector.

You do not have to carry out any special operation for outputting an S/P DIF digital signal from the [S/P DIF/DATA OUTPUT] connector, because it is always output there.

All you have to do for mixing down to an external digital device digitally is to connect the device to the [S/P DIF/DATA OUTPUT] connector. You can perform the digital mixdown during the mixdown process described in "Mixdown" of the "Basic recording/playback" chapter as well as in the mastering mode described in "Mastering mode" of this chapter.

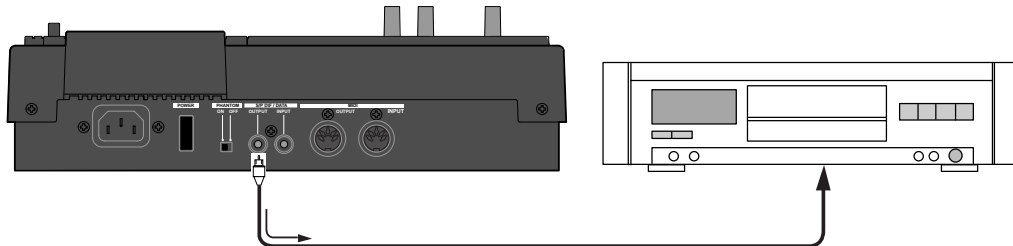

MIDI clock sync system

By setting any desired meter at any desired point of the programmable tempo map contained in the VF08, and by output of a MIDI clock and song position pointer according to the setting, a hardware type MIDI sequencer can be synchronized as a MIDI clock slave. Consequently, in this system, the VF08 will be the master and the MIDI sequencer the slave.

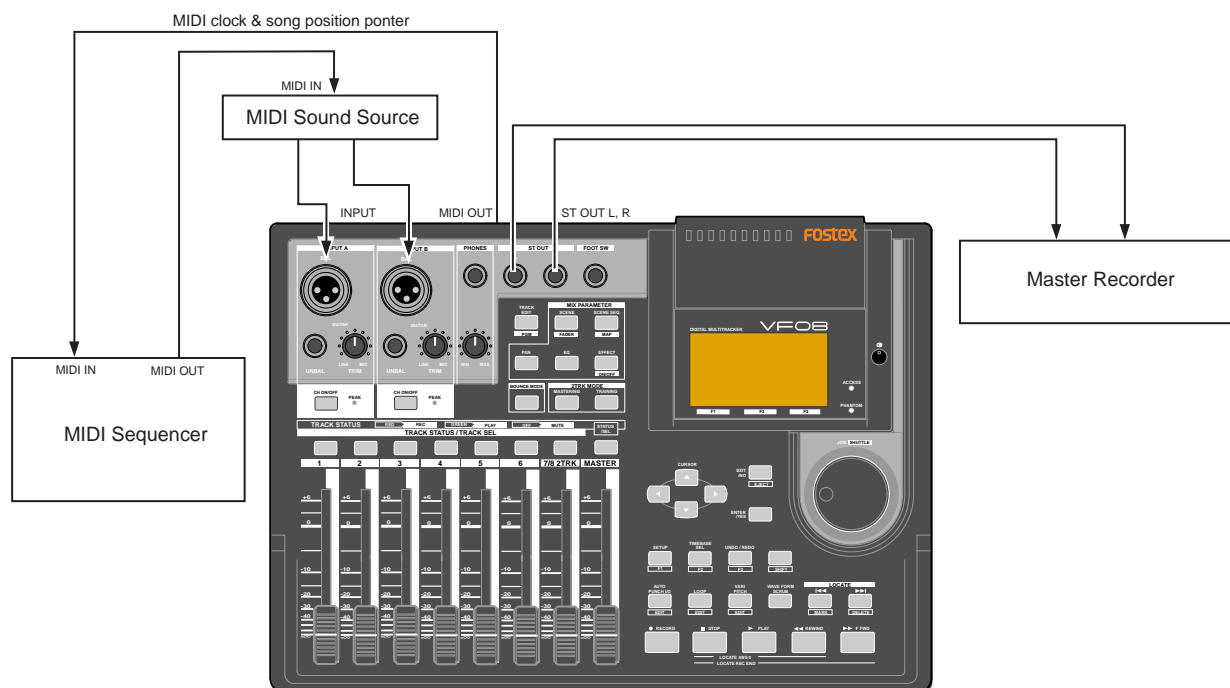

Connecting external equipment

- 1 Connect the VF08 MIDI OUT to MIDI IN of the MIDI sequencer.

- 2 Set the MIDI sequencer for "external sync mode (EXTERNAL SYNC) by MIDI clock." Refer to the Owners Manual of the equipment in use for details.

Advanced Operation

Setup of the VF08

- 1 Because the MIDI clock and song position pointer will be output from the VF08, set the SETUP mode "MIDI sync signal output setting" to "CLK."
Refer to page "103", SETUP mode "MIDI sync signal output setting" for correct operating procedures.
- 2 The meter in the desired bar can be set by "Time signature setting" of the SETUP mode.
Refer to page "99", SETUP mode "Time Signature Setting" for operating procedure.
- 3 Tempo in the desired bar can be set by "Tempo setting" of the SETUP mode.
Refer to page "101", SETUP mode "Tempo Setting" for operating procedure.
- 4 Set the SETUP mode "Metronome setting" to "On" if click sound is to be output according to the setup tempo map.
Refer to page "102", SETUP mode "Metronome setting" for operating procedure.
- 5 Press the [TIME BASE SEL] key, and then change the time base display to BAR/BEAT/CLK.

Executing of recording

Various ways of recording can be conducted while synchronizing the VF08 and the MIDI sequencer with the MIDI clock.

Confirming the MIDI clock sync

During recording and at playback following the recording, the time base (BAR/BEAT/CLK) is displayed in accordance to the setup tempo map, and the MIDI clock and song position pointer is also output. Confirm that the travel position (BAR/BEAT/CLK) of the VF08 and the travel position of the synchronized MIDI sequencer are matched.

If correct sync cannot be obtained, re-check the connections/cables and setting of both equipment.

<Note>

In the VF08, the "ABS 0" position is set at "-002BAR/1BEAT/00CLK." This setting is made in consideration of the time required (it will not sync immediately) for the MIDI sequencer, etc. to enter into sync. As a result, if the VF-16 is played back from ABS 0 (LOCATE ABS 0), sync will be completed by the time it reaches the first bar, and will thus synchronize from head of the tune.

MTC sync/MIDI machine control system

The following will explain synchronization by the MTC (MIDI time code) output and the computer controlling system using MMC (MIDI machine control). In this system, the VF08 will be the master and the computer (with sequence software) will be the slave. The VF08 will attach any desired offset (time difference) against ABS time (absolute time) and output it as MTC in any desired frame rate. It can also carry out the proper operation upon receiving an MMC from outside. In this case, because the VF08 can setup a DEVICE ID number by the SETUP mode "MIDI Device ID Setting" menu, a multiple number of the VF08's can be separately controlled by changing the DEVICE ID numbers in the transmitted message from the computer.

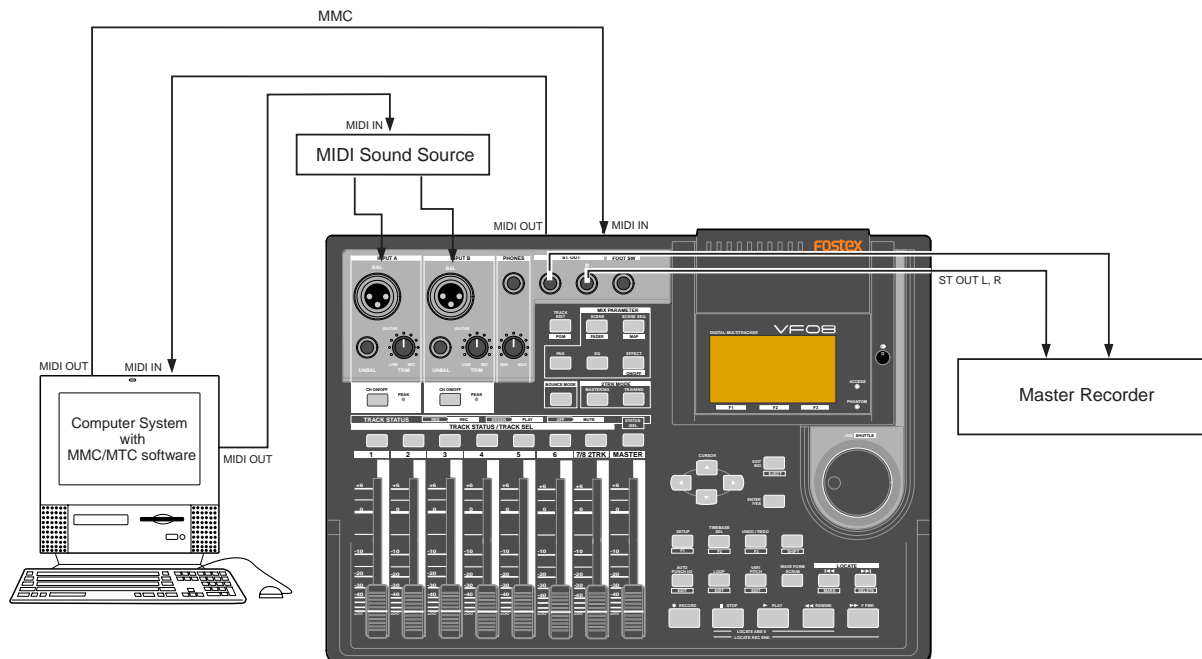

Connecting to external equipment

- 1 Connect the VF08 MIDI IN/OUT to the computer (with MIDI interface) MIDI IN/OUT.
MMC/MTC complied sequence software is activated in the computer.

Setup of external equipment

- 1 Setup the following in the sequence software.
 - * Set to MTC external sync mode (EXTERNAL SYNC).
 - * Set for output of MMC.
 - * Set to the desired MTC read out frame rate.
 - * Set start time of the tune (which MTC time is to be the first bar). Refer to precaution in regards to MTC offset, farther on.

For details, refer to Owners Manual of the external equipment.

Setup of the VF08

- 1 Because MTC will be output from the VF08, set to "MTC" the SETUP mode "MIDI sync signal output setting."
Refer to page "103", SETUP mode "MIDI sync signal output setting" for operating procedure.
- 2 Set a random offset time by the SETUP mode "MTC offset time setting."
Refer to page "104", SETUP mode "MTC offset time setting" for operating procedure.
- 3 In the SETUP mode "MTC offset mode setting," whether the MTC offset time setup in Step 2 should be output (ABS) at the ABS 00m 00s 00f 00sf position or at the 001BAR 1BEAT 00CLK (bar, signature) must be selected.
Refer to page "104", SETUP mode "MTC offset mode setting" for operating procedure.
- 4 Setup to the same frame rate as that setup by the sequence software by "MTC Frame rate setting" of the SETUP mode.
Refer to page "103", SETUP mode "MTC Frame rate setting" for operating procedure and details.
- 5 Set to the same figure as the sequence software MMC device number by the SETUP mode "MIDI device ID setting."
When the sequence software transmits by "7F," it means "ALL DEVICE" and therefore, it need not be setup.
Refer to page "108", SETUP mode "MIDI device ID setting" for operating procedure and details.
- 6 Press the [TIME BASE SEL] key, and then change the time base display to MTC.

<Notes on MTC related setups>

By "MTC offset time setting" and "MTC offset mode setting," at what position (ABS 0 or 001BAR/1BEAT/00CLK) should the setup MTC (MTC offset time) is to be output is set. When setting the start time of the tune in the sequence software by these setups, be careful of the following points.

* Offset mode: For ABS

If playback is started from ABS 0, since MTC will be output starting from the MTC offset time that has been set, the start time of the tune set by the sequence software must be set about 3 seconds later from the MTC offset time that was setup. This will provide time because the sequence software cannot sync immediately after MTC is output. For example, if the initial setting of 00h 59m 57s 00f 00sf" is used, set the start time of the tune to "01h 00m 00s 00f."

If playback is thus started from ABS 0 (LOCATE ABS 0), sync will be obtained by the time it reaches the first bar and therefore it can be made to sync from the head of the tune.

* Offset mode: For BAR

As mentioned before, because the "ABS 0" position is set at the "002BAR / 1BEAT / 00CLK" position, the setup MTC offset time can be set to the head of the tune without taking into account the time until reaching sync, as mentioned above. The length of the time two bars beforehand will change in accordance to the first bar setting for "signature" and "tempo." For example, it will be long if the tempo is set slow. This mode can be effectively applied when using the MIDI clock and MTC in parallel, and when using MTC for the sync signal while controlling the recorder with time base BAR/BEAT/CLK.

Confirming MTC sync/MMC

- 1 During recording and at playback after recording, time base MTC is displayed according to the setting and MTC is output at the same time.
Check that the VF08 traveling position (MTC) and the traveling position of the sequence software in sync are matched.
- 2 Send MMC commands such as PLAY, STOP and LOCATE from the sequence software to see that the VF08 will be properly controlled.
When a correct MIDI command (MMC or FEX) is received, "MIDI" in the display will be lit for about 40msec.
There is no setting in the VF08 to receive MMC but it will operate if a correct MIDI signal is input.

If sync and control cannot be done correctly, re-check connections/cables and the setting of both equipment.

Execution of recording

Carry out various recordings while synchronizing the VF08 and a MIDI sequencer with the MIDI clock.

External MIDI equipment sync system by the slave mode

Up to this point, synchronization with external MIDI equipment has been explained with the VF08 as the master and MIDI equipment as the slave but depending on the slave mode setting, the MIDI equipment can be set as the master and the VF08 as the slave.

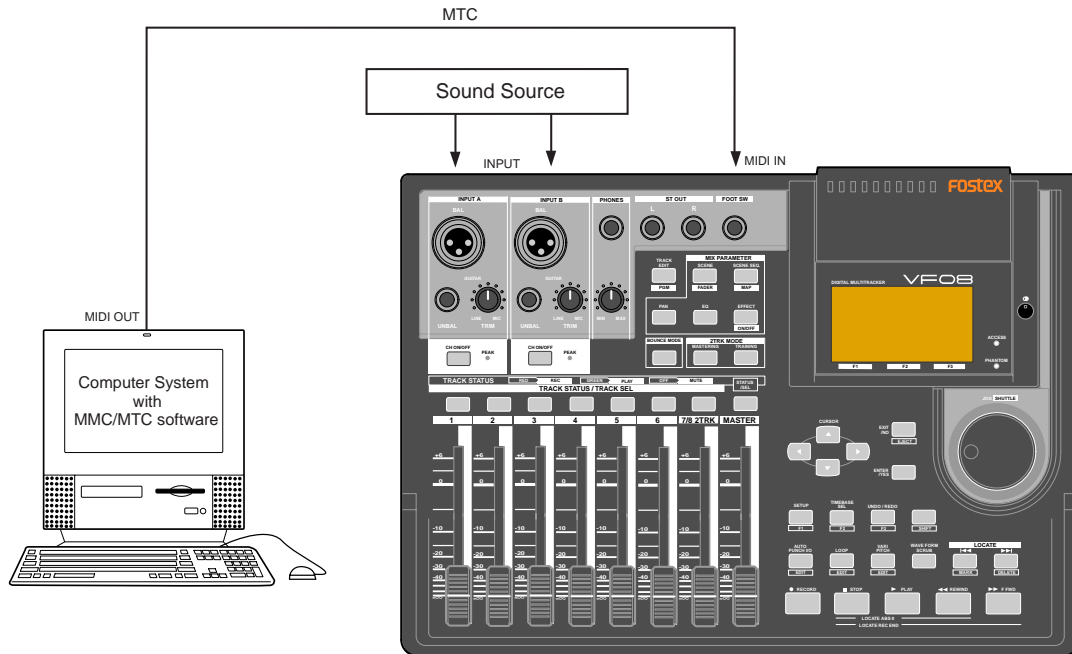

Connection to external equipment

- 1 Connect MIDI OUT of the computer (with MIDI interface) with MIDI IN of the VF08.
The computer sequence software complying to MMC/MTC must be activated.

Setup of external equipment

- 1 Sequence software is setup as follows.

- * Set for output of MTC.
- * Set frame rate of the MTC to be output.
- * Confirm start time of the tune.

Refer to Owners Manual of the respective equipment for details.

Setup of the VF08

- 1 Set to same frame rate as the sequence software by the SETUP mode "MTC Frame rate setting."
Refer to page "103", SETUP mode "MTC Frame rate setting" for operating procedure and details.
- 2 Set to the desired mode by the SETUP mode "MTC offset mode setting."
Refer to page "104", SETUP mode "MTC offset mode setting" for operating procedure and details.
- 3 A random offset time can be set by the SETUP mode "MTC offset time setting."
Refer to page "104", SETUP mode "MTC offset time setting" for operating procedure and details.

- 4 Set slave mode to "On" by the SETUP mode "Slave mode setting."
Refer to page "105", SETUP mode "Slave mode setting" for operating procedure and details.

- 5 Set slave type to "Vari" by the SETUP mode "Slave type setting."
Refer to page "105", SETUP mode "Slave type setting" for operating procedure and details.

- 6 Press the [TIME BASE SEL] key, to change the time base display to MTC.

Confirming chase lock

- 1 When the sequence software is played, "CHASE" and "MTC" in the display will be light and the chase lock will be completed.
Check that the MTC output by the sequence software and MTC time displayed in the VF08 are the same.
- 2 When the sequence software stops, MTC will be interrupted and the VF08 will also stop.
"CHASE" in the display will change from lit to blinking.
- 3 During FF/REW of the sequence software, the VF08 will remain stopped but upon starting to record, the VF08 will immediately chase lock.
Should it not be possible to chase lock, re-check connections / cables and all settings.

Execution of recording

Carry out various recordings while the recorder is chase locked to the sequence software.

<Precautions at MTC related setups>

The position (ABS 0 or 001BAR/1BEAT/00CLK) when the setup MTC (MTC offset time) should be output was setup by the “MTC offset time setting” and “MTC offset mode setting.” In accordance to start time of the tune set by the sequence software, setup as explained below.

Offset mode: For ABS

Set the MTC offset time about three seconds prior to the start time of the tune set by the sequence software. Because the recorder cannot immediately chase lock after input of MTC, in order to sync the unit from head of the tune, set the preroll using the sequence software, and playback from before the actual head of the tune to allow the recorder to enter into sync by the time it arrives at the head of the tune.

Offset mode: For BAR/BEAT

The MTC offset time can be set to the same time as the start time of the tune set by the sequence software. Because the “ABS 0” position is set at the “0002BAR/1BEAT/00CLK” position in the unit, as mentioned before, the preceding time required for sync is already set. The preceding time of two bar lengths could change in length depending on the first bar’s “signature setting” and “tempo setting” mentioned before. For example, it will be longer if the tempo is slowed down.

<One Point Advice>

Sync signal “Vari” of the “Slave mode setting” menu: When the VF08 is made to chase lock by MTC only, variable pitch will be constantly applied by external MTC. If a digital signal is output to an external digital equipment from the VF08, it will not be able to follow the speed difference (MTC speed difference of the master) of the VF08 and the external digital equipment, in some cases, may not be able to input a continuous digital signal.

As a counter measure, the sync signal should be set to “Free” by the “Slave mode setting” menu. Using this setting, the VF08 will enter self operation by the internal clock, after completion of chase lock, and it will be possible to supply a stable digital signal to the external equipment.

Under this setting, when MTC drift between the master recorder and slave recorder exceeds 10 frames, the VF08 will assume that chase lock has been disengaged and the slave recorder will carry out position matching again with the master unit (re-chase operation). During the re-chase operation, sound output will be muted and the digital signal will also be interrupted.

If it is within 10 frames, the slave recorder will continue to run while admitting this drift.

<Notes>

* Chase lock of the VF08 by MTC only is permissible when speed difference of the MTC from the master is within +/- 5.6%.

Against the MTC within this range, variable pitch will be constantly applied internally for chasing. Chase lock, however, will not function against MTC at a speed difference outside this range. Also, when the master speed difference is large, it is advised to let the VF08 learn the master speed by entering PLAY prior to recording. By doing so, it will be lock faster from the second and later sessions.

* Normally, when “Setup of slave type” is set to “Vari,” the VF08 will be constantly controlled by vari-pitch and follow the MTC, which is the master. However, if the digital input is set to “On” via the SETUP mode “Setup of digital input,” it will be in “Word clock external sync operation” by the digital signal (S/P DIF) that is input.

Therefore, it must be noted that when “Setup of digital input” is executed, even though “Setup of slave type” is set to “Vari,” it will not follow by application of vari-pitch and upon completion of lock, it will change to external sync operation by the digital input signal.

Save/Load of song data

You can save or load song data (including audio and setup data) using a digital audio recorder via the S/P DIF digital signal, as well as using a SCSI backup device.

This function allows you to save finished or unfinished song data to a digital recorder or a SCSI backup device, and load the data later.

*****About song data*****

There are two methods of saving/loading song data depending on the digital signals used to handle the data, which are S/PDIF digital and SCSI. The data format and time required for the save/load operations are different between each method.

•Using the S/PDIF digital signal (you can save/load data for each program individually.):

Following to five seconds of the pilot signal (shown in gray in the diagram below), the song data is output to an external digital audio device such as a DAT recorder.

The audio data is divided into data blocks of track pairs (shown in black in the diagram below) and transferred. To save data for Real tracks 1 through 8, 4 two-track data are transferred. To save all tracks including the Additional tracks in addition to the Real tracks, 12 two-track data are transferred. Therefore, it will take about 4 times as much as the recorded time of a program (from ABS 0 to REC END) to save the Real tracks 1 through 8 of the program, while it will take about 12 times to save all the data including the Additional tracks.

When loading song data from the external device to the VF08 via the S/PDIF digital signal, data is transferred with two-track data blocks, as with the same way as saving data from the VF08 to the external device. (See also <Notes> on the next page.)

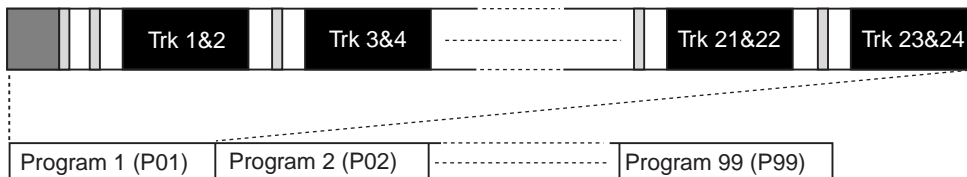

•Using a SCSI disk (you can save/load data for each program individually.):

See the following <Note>.

When using a SCSI disk, all audio data including both the Real and Additional tracks (shown in black in the diagram below) is transferred simultaneously. Therefore, you can save or load a program much faster than using the S/PDIF signal. Note that no pilot tone or beep sound is recorded when saving data to a SCSI disk. If song data to be saved requires more space than the available disk space, you can save the data to more than one disk (up to 99 disks). You can also save/load data to/from a DOS formatted disk by the WAV file format. In the save/load operation using the WAV file, you can specify any track(s) to be saved or loaded, as well as all tracks.

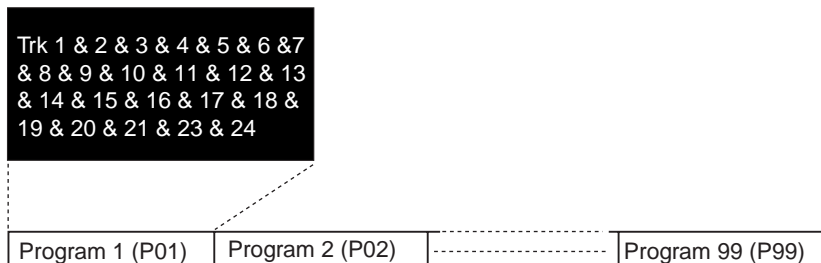

<Note>
 To save/load using a SCSI disk, you must install the optional SCSI card (Model 8340) in the VF08.
 For the detailed information about the SCSI card, contact your dealer or the nearest FOSTEX sale office. See last page about how to install the SCSI card in the VF08.

<Items that can be saved or loaded as song data>

•Memory data:

AUTO PUNCH IN/OUT data and Start/End/To points,
Scene memories 00 through 99, Marks 00 through 99 (only can be saved/loaded using SCSI)

•Timebase:

ABS, MTC or BAR/BEAT/CLK

•Setup mode:

Bar/beat setting, tempo setting, metronome on/off, preroll time, MIDI synchronization output signal setting, MTC offset time, MTC offset mode, REC protect setting, slave mode on/off, and slave type setting
Fader fix mode setting, fader recall mode setting

<Items that cannot be saved or loaded as song data>

•On/off settings for auto play mode and auto return mode

•Vari pitch on/off and pitch data

•Setup mode:

DIGITAL IN and DIGITAL OUT settings, bar/beat resolution on/off and device ID

<Notes for digital audio recorders to be used>

The VF08 song data only can be saved to or loaded from digital recorders that can handle 16 bit, 44.1 kHz linear digital data with S/PDIF format (such as DAT recorders).

<Notes for saving data using the S/PDIF digital signal>

When saving all data including both real and Additional track data using the S/PDIF digital signal, note the following.

Only the data recorded within the time duration between ABS 0 and REC END of the Real tracks is saved. Therefore, if the recorded time of Additional tracks is longer than the Real tracks, only the Additional track data within the time duration between ABS 0 and REC END of the Real tracks is saved.

In the example shown on the right, the Additional tracks have data from "00m 00s" to "10m 00s", while the Real tracks have data from "00m 00s" to "07m 00s".

If you are going to save all tracks, the Additional track data from "00m 00s" to "07m 00s" will be saved but the rest will not be saved.

In such a case, you can solve the problem by setting the time length of saved data to 10 minutes by using the "Save Length" screen mentioned later (see "step 4" on page 83). Note that the maximum save length is 59 minutes 59 seconds.

The other way to solve the problem is to exchange the Additional track data and the Real track data before saving data. You should be careful not to lose the Additional track data in this operation. See page 63 about the track exchange operation.

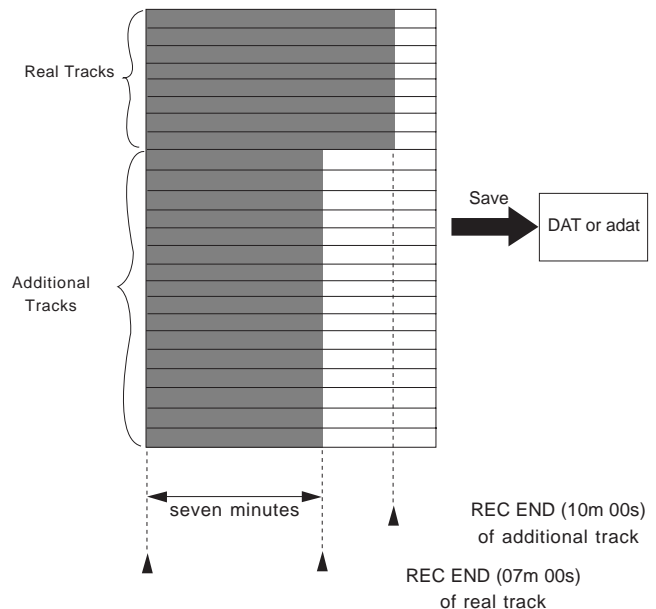

Saving data using the S/PDIF digital signal

You can save data using the S/PDIF digital signal via the [S/P DIF DATA OUTPUT] (coaxial) jack.

*Use an external digital recorder that supports 44.1 kHz sampling frequency (the same as the VF08).

Connecting to an external digital recorder

Connect the [S/P DIF DATA OUTPUT] jack to the digital input jack of the external digital recorder (DAT, etc.).

<Note>

Do not do anything, such as unplug the connecting cable, that interrupts the digital signal until the saving operation is completed. Otherwise, the unit may generate a noise which damages an external recorder.

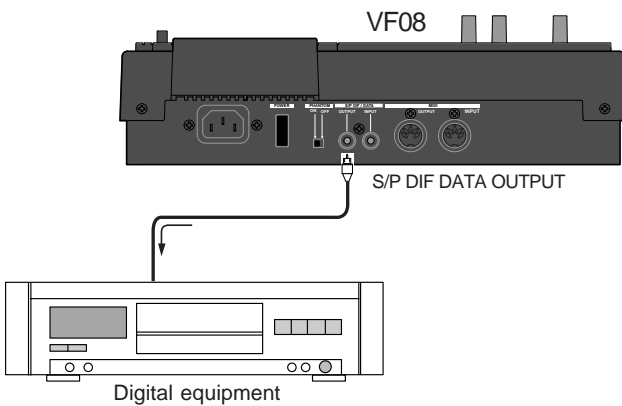

- If your digital recorder only provide the optical digital input jack and does not provide the coaxial jack, use the optional COP-1 (optical/coaxial converter).
- Do not connect digital signals for both directions between the VF08 and the external recorder (i.e. the digital output of the VF08 to the digital input of the external recorder and the digital output of the external recorder to the digital input of the VF08), which may form a digital loop and cause feedback.

Setting the external recorder

- 1 Set the sampling frequency to 44.1 kHz (the same as the VF08).
- 2 Set the input source to "digital input" to accept the signal from the VF08.
Some machine also needs to select the clock reference to "external" when setting the input source to "digital input". See the operation manual of the machine for the detailed information.

<Note>

If you cannot hear the input signal or you hear digital noise when monitoring the source signal of the external digital recorder, check the connections, cables and settings of both the VF08 and the external recorder.

*See the operation manual of the external recorder for the detailed information.

Saving data

You can save data via the "Save PGM" menu in the setup mode.

<Details about "Save PGM" menu>

- Output signal options: S/PDIF and SCSI
- Program options: P01 to P99 (an individual Program)
- Track options:
When using S/PDIF:
Tracks 1-8, Tracks 1-16, Tracks 1-24, Tracks 9-16, Tracks 9-24 or Tracks 17-24.
When using a SCSI disk:
All tracks (1-24) is selected automatically. (You can select tracks individually when saving by the WAV file format).

- 1 Press the [SETUP] key to enter the setup mode.
The display shows the screen for selecting the setup menu.
- 2 Use the [JOG] dial to select "Save PGM" and press the [ENTER/YES] key.
The display shows the screen for selecting the device to which the data is saved. "SCSI" blinks.

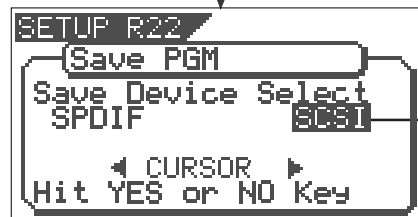
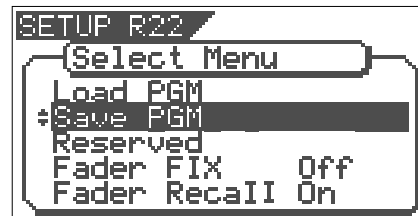

Blinking

"SCSI" should be selected when saving or loading data via "SCSI."

- 3 Use the [JOG] dial or [CURSOR] keys to select "SPDIF" and press the [ENTER/YES] key.
The display shows the screen for selecting the program to be saved.
The program number currently selected blinks, while the data size of the program is shown. While a program number is blinking, you can select the desired program to be saved.

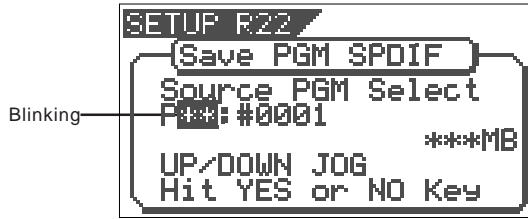

- 4** Use the [JOG] dial to select the program to be saved and press the [ENTER/YES] key. The display shows the "Save Length" screen. Initially, the recorded time length of the selected program (ABS 00 to REC END) is shown as the time length of data saving. Normally you do not need to edit the length but you may edit it to the desired value if needed.

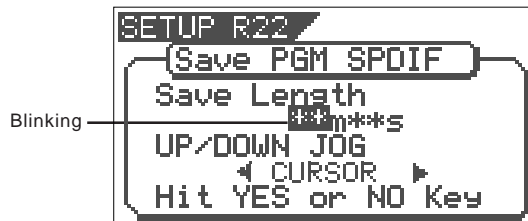

For example, if the actual recorded time is 9 min. 00 sec., you can make the length of the data to be saved shorter or longer than 9 min. 00 sec., as long as the length does not exceed 59 min.59 sec. The initially displayed value here is the length of the Real track, therefore, as noted earlier, you may edit the value to match the length of the Additional track if it is longer.

To edit the save length
Use the [CURSOR] keys to move the blinking field between "minutes" and "seconds".
Use the [JOG] dial to set the value for the blinking field.

- 5** Press the [ENTER/YES] key. The display shows the screen for selecting tracks to be saved.

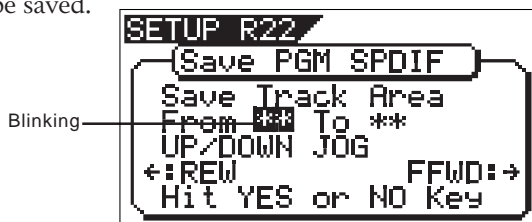

- 6** Select tracks to be saved. Use the [CURSOR] keys to move the blinking field between "From" and "To". Use the [JOG] dial to set the track number for the blinking field.

For the "From" field, you can select from 1, 9 and 17. For the "To" field, you can select a higher value than the "From" field value among 8, 16 and 24. Accordingly, you can set "Save Track Area" to one of the following.

"From 1 To 8", "From 1 to 16", "From 1 To 24", "From 9 To 16", "From 9 To 24", and "From 17 To 24"

<Note>

When you save tracks including Additional tracks, read <Notes for saving data using the S/PDIF digital signal> on page XX before executing the save operation.

- 7** After selecting tracks, press the [ENTER/YES] key again. The display shows "Rec Start Recorder!" together with the program and tracks to be saved, and "Sure?" blinks. If you are sure to start saving data to the recorder, go on to the next step.

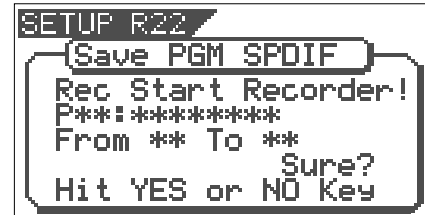

- 8** After checking all preparations on the external recorder are made, start it recording. It may be a good idea to put a Start-ID (for DAT) or set a locate memory at the starting position so that you can easily find the position when you load the data later.

- 9** Press the [ENTER/YES] key immediately after the external recorder starts recording. The display shows something like the one below. After a few seconds, the unit starts saving the data and "Wait time" starts counting down.

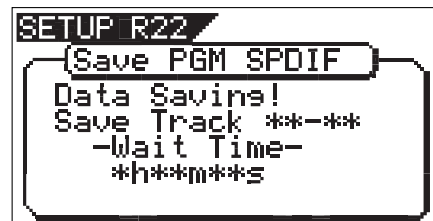

For the first several seconds, the VF08 transmits the pilot signal that will be a reference for locating the tape position during the load operation, and the actual data saving starts from the position at which "Wait time" starts counting down. Data is saved in 2-track unit. When the data saving is completed, "Completed!" appears on the screen and the VF08 stops.

<Note>

If you interrupts saving before completing, the saved data is invalid.

- 10** Stop the external recorder.
11 Press the [EXIT/NO] key (or the [STOP] key) repeatedly until exiting the setup mode.

To cancel each operation or to return to the previous screen before pressing the [ENTER/YES] key, press the [EXIT/NO] key (or the [STOP] key). Each press of the key returns to the previous screen level and finally exits the setup mode.

Loading data using the S/PDIF signal

You can load data using the S/PDIF digital signal via the [S/P DIF DATA INPUT] (coaxial) jack.

*Use an external recorder that supports 44.1 kHz sampling frequency (the same as the VF08).

Connecting to an external recorder

Connect the [S/P DIF DATA INPUT] jack to the digital output jack of the external digital recorder.

<Note>

Do not do anything, such as unplug the coaxial cable, that interrupts the digital signal until the loading operation is completed. Otherwise, the unit may generate a noise which damages an external recorder.

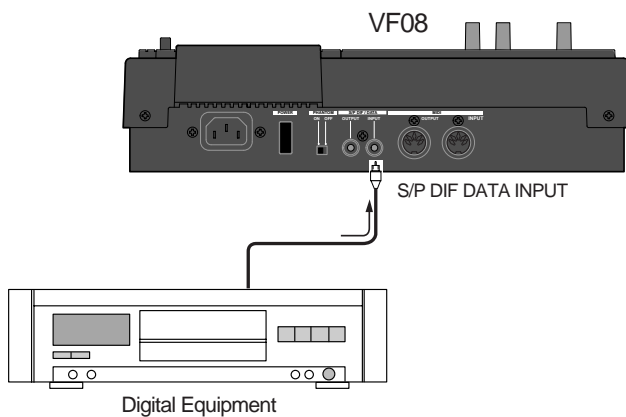

- If your digital recorder only provide the optical digital input jack and does not provide the coaxial jack, use the optional COP-1 (optical/coaxial converter).
- Do not connect digital signals for both directions between the VF08 and the external recorder (i.e. the digital output of the VF08 to the digital input of the external recorder and the digital output of the external recorder to the digital input of the VF08), which may form a digital loop and cause feedback.

Setting the external recorder

- 1 Make preparations of the external recorder for outputting the digital signal.
- 2 Locate the beginning of the pilot signal for the song data.

*See the operation manual of the external recorder for the detailed information.

Loading data

You can load data via the "Load PGM" menu in the setup mode.

<Details about "Load PGM" menu>

- Input signal options: S/PDIF and SCSI
- Program options: P01 to P99 (an individual Program)
- Track options:
 - When using S/PDIF: Tracks 1-8, Tracks 1-16, Tracks 1-24, Tracks 9-16, Tracks 9-24 or Tracks 17-24.
 - When using a SCSI disk: All tracks (1-24) is selected automatically. (You can select tracks individually when saving by the WAV file format).

- 1 Press the SETUP key to enter the setup mode. The display shows the screen for selecting the setup menu.
- 2 Use the [JOG] dial to select "Load PGM" and press the [ENTER/YES] key. The display shows the screen for selecting the recorder from which the data is loaded. "SCSI" blinks.

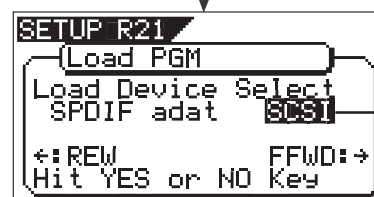
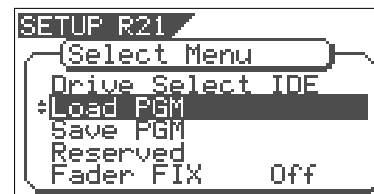

- 3 Use the [JOG] dial or [CURSOR] keys to set "Load Device Select" to "SPDIF" and press the [ENTER/YES] key. The display shows the screen for selecting a load destination program to which data is loaded. A program number currently selected blinks, followed by its program name. The data size of the current program is also shown. When a program number is blinking, you can select the desired load destination program.

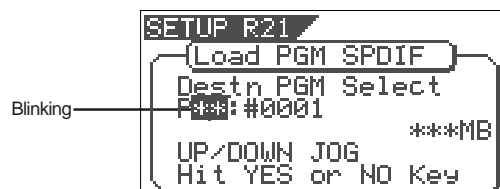

You can select a load destination program from existing programs on the current drive as well as "New PGM". When selecting "New PGM", a new program is created.

*If you load data to a program in which data is already recorded, the newly loaded data overwrites the current data track by track. Consequently, on each overwritten track, the loaded data becomes valid while the current data is erased.

- 4 Use the [JOG] dial to select the program to which data is loaded and press the [ENTER/YES] key. The display shows the screen for selecting tracks to be loaded.

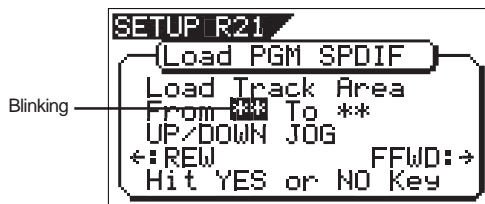

- 5 Select tracks to be loaded. Use the [CURSOR] keys to move the blinking field between "From" and "To". Use the [JOG] dial to set the track number for the blinking field. For the "From" field, you can select from 1, 9 and 17. For the "To" field, you can select from 8, 16 and 24. For example, if you select "From 1 to 24", data for all tracks (1 to 24) will be loaded.

- 6 After selecting tracks, press the [ENTER/YES] key again. The display shows something like the one below. A load destination program (existing or new program) to which the data is loaded and tracks to be loaded are shown, while "Sure?" blinks.

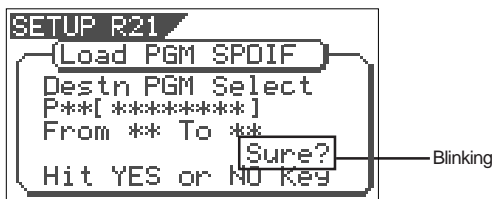

<Note>

In the above step, if the VF08 does not lock to the digital signal from the external digital recorder, the following warning message appears on the display, showing that the VF08 does not receive a correct S/PDIF digital signal. So check the cable connection and the digital output setting of the external digital recorder.

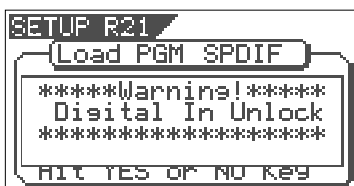

- 7 When the VF08 is locking to the digital input signal, press the [ENTER/YES] key. The display shows "Play Start Player!".

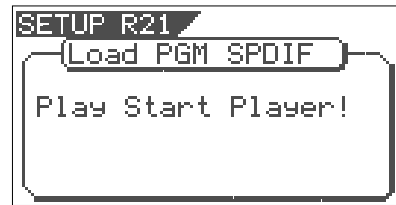

- 8 Start playback of the external recorder. After reading the pilot signal recorded when saving the data, the data starts loading automatically. When starts loading, the display shows something like the one below, in which "Wait time" starts counting down.

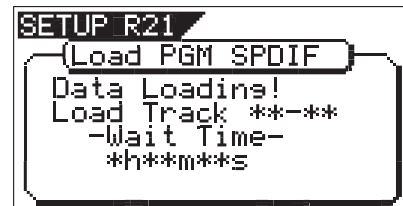

Data is loaded in 2-track unit. While loading, the [TRACK STATUS/TRACK SEL] keys for channels 1 and 2 flash, while the input levels are displayed by level meters 1 and 2.

When the data loading is completed, "Completed!" appears on the screen.

<Note>

If you quit loading before completing, the loaded data is invalid.

- 9 Stop the external recorder.
- 10 Press the [EXIT/NO] key (or the [STOP] key) repeatedly until exiting the setup mode.

To cancel each operation or to return to the previous screen before pressing the [ENTER/YES] key, press the [EXIT/NO] key (or the [STOP] key). Each press of the key returns to the previous screen level and finally exits the setup mode.

Saving/loading data using SCSI

If you install the optional SCSI card (Model 8340) in the VF08, you can save/load song data using a SCSI backup disk. A backup SCSI disk can be formatted by the Fostex backup format (FDMS-3) from the VF08, however, you can also save data to or load data from a WEV file on a SCSI disk formatted by the DOS format (for computer use). Since song data written in a WAV file can be read by a computer, as well as can be loaded to the VF08, you can use the data with a music software.

Connecting to an external device

After installing the Model 8340 SCSI card, connect the SCSI connector on the card (half pitch 25-pin type for Macintosh) to an external SCSI device.

<Notes>

- Make connection with the power turned off.
- You can connect only one SCSI device via the SCSI connector of Model 8340 SCSI card. When connecting a external SCSI device to the Model 8340 SCSI card, insert a SCSI terminator to the other (unused) SCSI connector of the device. Or, if the device provides a switch that switches the SCSI termination, set it to ON.
- There is no limitation for the ID number of the backup SCSI device. The unit automatically recognizes the device as a backup SCSI device.
- You must format the disk used with the backup SCSI device after connecting the device. See "Formatting a backup disk" below for the detail information.

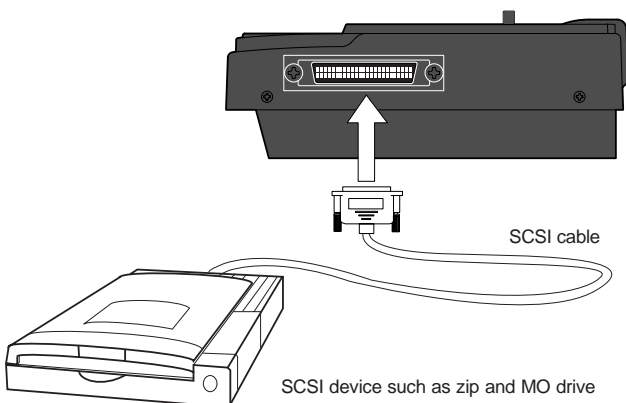

Formatting a backup disk

You can use an unformatted disk or disk currently used for a computer, etc. When formatting a disk currently used for a computer, make sure that you do not need the data recorded on the disk. Once you start formatting, you cannot stop or cancel formatting. The following procedure assumes that a removable disk is used.

<Notes>

- A write-protected disk cannot be used. Release the protection before using.
- The disk formatted by the VF08 can be used for saving/loading by the FDMS-3 format. The VF08 cannot DOS-format a disk for saving/loading by a WEV file. So, to DOS-format a disk, use a personal computer, etc.

- 1 After connecting a backup SCSI device to the VF08, turn on the both machine.
- 2 Insert a backup disk into the SCSI device.
- 3 Press the [SETUP] key to enter the setup mode. The display shows the screen for selecting the setup menu.
- 4 Use the [JOG] dial to select "Disk Format" and press the [ENTER/YES] key. The display shows the screen for selecting a drive. "IDE" (E-IDE hard disk) blinks.



- 5 Use the [CURSOR] keys to select (blink) "SCSI" and press the [ENTER/YES] key. The display shows the name of the SCSI device connected, and "Sure?" blinks.

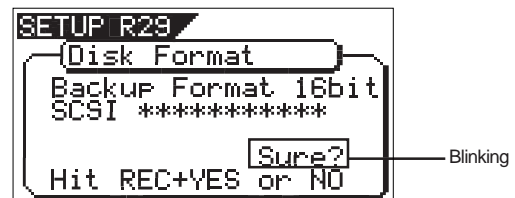

<Note>

The backup format of the VF08 is "Backup Format 16 bit." You cannot save VF08 song data to a disk formatted with 24-bit format by the Fostex D824 or D1624. If you set such a 24-bit formatted disk to the SCSI device, the VF08 display will show "Backup Format 24bit". Use only a 16-bit formatted disk.

- 6 While holding down the [RECORD] key, press the [ENTER/YES] key.
The unit starts formatting the backup disk.
When formatting is completed, "Completed!" appears on the screen.

- 7 Press the [EXIT/NO] key (or the [STOP] key) repeatedly until exiting the setup mode.

A backup SCSI disk is formatted and ready to be used for data saving/loading by the FDMS-3. If you continue to format another disk, remove the current disk and repeat the procedure above. To remove a disk, press the EJECT key on the SCSI device.

Saving data to a SCSI disk

You can save data via the "Save PGM" menu in the setup mode. When saving to a SCSI disk, you can save data for each specified program like saving to an audio recorder using the S/PDIF signal.

<Details about "Save PGM" menu>

- Output signal options: S/PDIF and SCSI
- Program options: P01 to P99 (an individual Program)
- Track options:
When using S/PDIF:
Tracks 1-8, Tracks 1-16, Tracks 1-24, Tracks 9-16, Tracks 9-24 or Tracks 17-24.
When using a SCSI disk:
All tracks (1-24) is selected automatically. (You can select tracks individually when saving by the WAV file format).

<Notes>

When saving a single program data to more than one removable disk, we suggest to put a number on each disk in the saving order so that you will easily know the order when loading the data later.

- 1 Press the [SETUP] key to enter the setup mode.
The display shows the screen for selecting the setup menu.
- 2 Use the [JOG] dial to select "Save PGM" and press the [ENTER/YES] key.
The display shows the screen for selecting the device to which the data is saved. "SCSI" blinks.

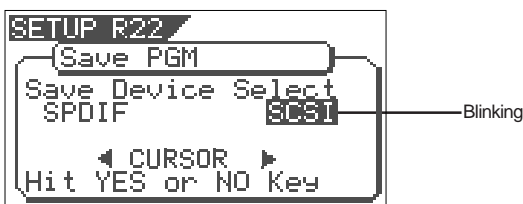

- 3 While "SCSI" is blinking, press the [ENTER/YES] key.
The display shows the screen for selecting the backup mode (FDMS 3 or WAV). If a disk formatted by the FDMS-3 is set, "FDMS3" blinks.

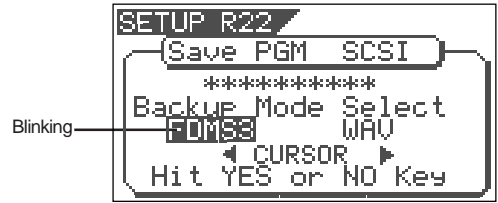

- 4 While "FDMS3" is blinking, press the [ENTER/YES] key.
The display shows the screen for selecting a program to be saved.
The program number currently selected blinks, while the data size of the program is shown.

<Hint>

If you select the backup mode to "WAV" and press the [ENTER/YES] key while a disk formatted by the FDMS-3 is set, the display shows "Warning Illegal Disk!" and the disk is ejected.

- 5 Use the [JOG] dial to select a program to be saved.
Depending on a program selected, the display shows as below.

- When selecting a vacant program (no data is recorded):
"OMB" is shown.

- When selecting a program that can be saved to a single backup disk:
The example below shows "68 MB".
This means the data size of the data is 68 MB and the data can be saved to a single disk.

- When selecting a program that needs more than one backup disk for saving.
The example below shows "2 Disks 130 MB".
This means the data size of the data is 130 MB and you need two disks to save the data.

Save/Load of Song data

- 6** After selecting the program, press the [ENTER/YES] key.

The display shows the difference screens depending on whether or not the program can be saved to a single disk, as below.

•When the program can be saved to a single disk:
The display shows the screens for creating a new program on the backup disk (the program number "B01" is shown for the backup disk) and "Sure?" blinks.

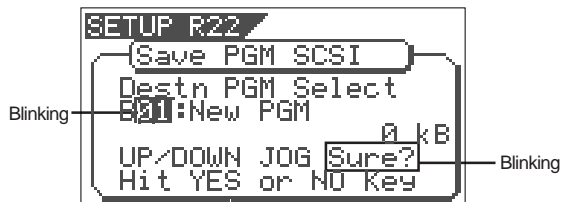

Pressing the [ENTER/YES] key in the above condition starts saving and the screens shown below appears.

<Hint>

While "B01: New PGM" is blinking, you can select "Eject" for the forced eject by using the [JOG] dial. When you remove the disk forcibly, select "Eject" and press the [ENTER/YES] key. The disk will be ejected and "Insert Disk" will blink on the display.

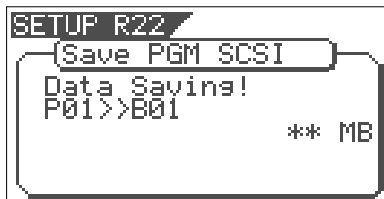

The screen above shows that the VF08 is saving the song data of program 01 to B01 on the backup disk. The remaining data size shown on the screen counts down while the data save goes on. Wait for a while until the save operation is completed.

When the save operation is completed, the display changes to something like the one as shown below, while the VF08 stops.

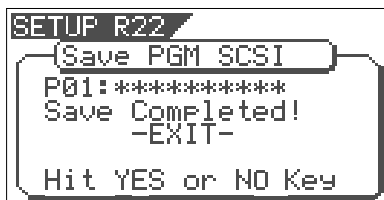

• When the program requires more than one disk for saving:

Pressing the [ENTER/YES] key immediately starts saving to the first disk and the "Data Saving" screen, same as described above, appears.

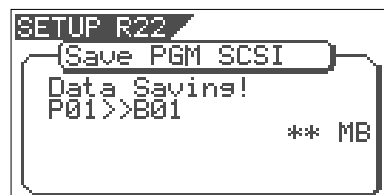

The first disk is ejected when it becomes full, and "Insert Disk2!" blinks on the screen.

Inserting the second disk to the SCSI device automatically resumes saving.

If more than two disks are required for saving, repeat the same procedure as above.

When the save operation to all disks is completed, "Completed!" appears on the display, while the VF08 stops.

<Note>

You cannot abort the save operation before completed, unlike the save operation using the S/PDIF signal. Especially during the save operation to more than one disk, if you happen to press the [EXIT/NO] key while removing or inserting a disk, you have to redo the save operation from the beginning using the first disk.

- 7** Press the [EXIT/NO] key (or the [STOP] key) repeatedly until exiting the setup mode.

• To remove the disk from the SCSI drive after the save operation is completed, press the eject key on the SCSI drive.

<Hint>

The save operations described above (both for using a single disk and multiple disks) are assumed that backup disks used are newly formatted and have no recorded data. It will be ideal to prepare newly formatted "clean" disks before the save operation, however, there must be some cases where you have to use disks containing recorded data or unformatted disks. See the following notes for such a case.

- If you are going to save to an unformatted disk:
The VF08 recognizes that the disk is "unformatted" after executing steps 1 through 4 described above, and the following screen appears.

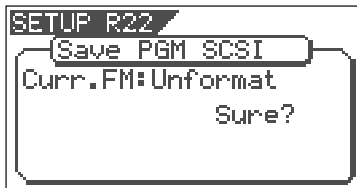

By pressing the [ENTER/YES] key while holding down the [RECORD] key, the disk is formatted and the display shows the screen for selecting the program to be saved, as described above.

- If you select a program to be saved to the backup disk which has saved data:
After executing steps 1 through 6 described above, the display shows the screen for selecting the program to be saved. You can select from existing programs on the backup disk and "New PGM". If you select an existing program and execute the save operation, the new data overwrites the program (the existing data is erased). If you select "New PGM", the data is saved to a newly created program, while other existing programs are unchanged.

- If you are going to save data to "New PGM" but the disk does not have enough available space for the data:
When you select "New PGM", the available disk space is shown. If you press the [ENTER/YES] key, "Disk Full!" is shown at the top of the screen and you cannot execute the save operation. In such a case, you may save data by overwriting an existing program. If you want to cancel the save operation, select "Eject" by using the [JOG] dial and then press the [ENTER/YES] key.

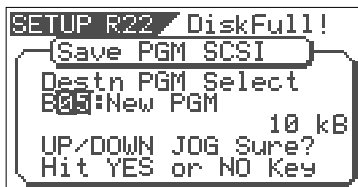

- If you are going to save data to a disk that is used as the current drive by another digital recorder:
After executing steps 1 through 4 described above, "Wrong Disk!" is shown and then the screen for prompting to format the disk shown above appears. you may format the disk by pressing the [ENTER/YES] key while holding down the [RECORD] key, or cancel the save operation by selecting "Eject" and then pressing the [ENTER/YES] key.

- In the saving operation using more than one disk, if you use a disk in which save data is already recorded:
When carrying out step 6 above, an existing program number is shown. In this condition, by using the [JOG] dial, you can select "Eject", as well as existing programs. To eject the disk, select "Eject" and press the [ENTER/YES] key.
If you save data to the disk, select any existing program and press the [ENTER/YES] key.
The display shows "Del All" and "Sure?" (blinking) as below.

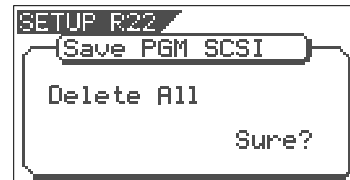

Press the [ENTER/YES] key while the above screen is shown. All backup data recorded in the disk are erased and then the save operation starts.

Loading from a single SCSI disk

You can load data using the "Load PGM" menu in the setup mode. The following procedure shows how to load song data saved to a single SCSI disk. See the next section for loading data saved to more than one SCSI disk.

- <Details about "Load PGM" menu>
- Input signal options: S/PDIF and SCSI
- Program options: P01 to P99 (an individual Program)
- Track options:
When using S/PDIF:
Tracks 1-8, Tracks 1-16, Tracks 1-24, Tracks 9-16, Tracks 9-24 or Tracks 17-24.
When using a SCSI disk:
All tracks (1-24) is selected automatically. (You can select tracks individually when saving by the WAV file format).

- 1 Press the [SETUP] key to enter the setup mode. The display shows the screen for selecting the Setup menu.
- 2 Use the [JOG] dial to select "Load PGM" and press the [ENTER/YES] key. The display shows the screen for selecting the device from which the data is loaded. "SCSI" blinks.

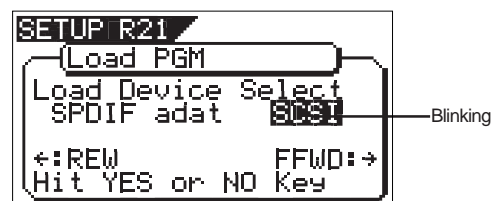

Save/Load of Song data

- 3** While "SCSI" is blinking, press the [ENTER/YES] key. The display shows the screen for selecting the program to be loaded. The backup number currently selected blinks, while the data size of the program is shown. While a backup number is blinking, you can select the desired program to be loaded. If a disk has more than one program saved, you can select the desired program by using the [JOG] dial.

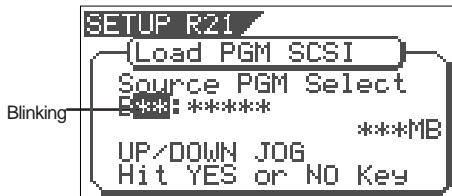

• You can also select "Eject" as well as programs to be loaded in the condition above. To eject the disk, press the [ENTER/YES] key after selecting "Eject".

- 4** Use the [JOG] dial to select the program to be loaded and press the [ENTER/YES] key. The display shows the screen for selecting the destination program to which data is loaded. In the default setting, "New PGM" is selected so that the data is loaded to a newly created program.

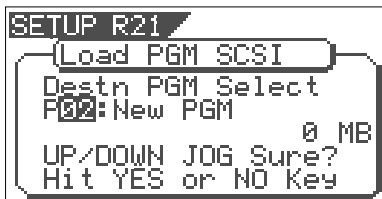

You can select any existing program available on the current drive by rotating the [JOG] dial besides "New PGM". When selecting an existing program, the data size of the program is also shown.

When you load the data to any existing program, the backup data overwrites the existing data. If you do not like to overwrite any track, select "New PGM".

<Note>

If the current drive disk (destination disk of loading data) does not have enough available space for accepting the loaded data, The display shows "Disk Full" and the returns to the screen shown when carrying out step 3.

- 5** Use the [JOG] dial to select the load destination program and press the [ENTER/YES] key. The data load to the selected program starts. The following screen example shows that the "B01" data on the backup disk is now being loaded to "P02" on the current disk. As the data load goes on, the remaining data size shown on the screen counts down.

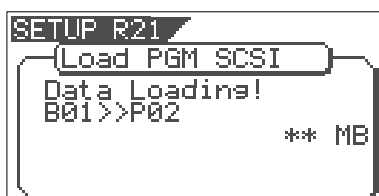

<Note>

You cannot abort the load operation before completed using SCSI, unlike the load operation using the S/PDIF signal.

When the load operation is completed, "Completed!" appears, while the VF08 stops.

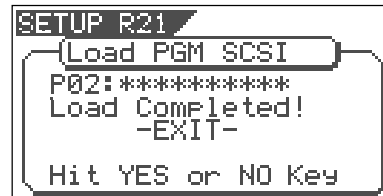

- 6** Press the [EXIT/NO] key (or the [STOP] key) repeatedly until exiting the setup mode.

Loading from more than one disk

The following procedure shows how to load song data saved to two SCSI disks.

- 1 Insert the first disk (Disk-1) to the SCSI device.
- 2 Carry out the same procedures as steps 1 through 3 described in the previous section "Loading from a single disk". The display shows the screen for selecting a program loaded. If the program is saved over more than one disks, backup file number "B01" blinks, as well as the recorded data size is shown.

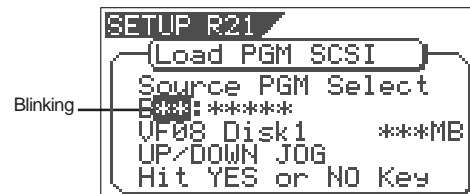

• By using the [JOG] dial in this step, you can select "Eject" as well as destination programs. To eject the disk, select "Eject" and press the [ENTER/YES] key.

<Note>

If Disk-2 (the second disk when saving) is inserted in mistake, the VF08 automatically recognized that the wrong disk is set. The display shows "Wrong Disk", followed by "Illegal No!", and the disk is automatically ejected. Then, as the display shows "Insert Disk", insert Disk-1.

- 3** Press the [ENTER/YES] key. The display shows the screen for selecting the destination program to which data is loaded. In the default setting, "New PGM" is selected so that the data is loaded to a newly created program.

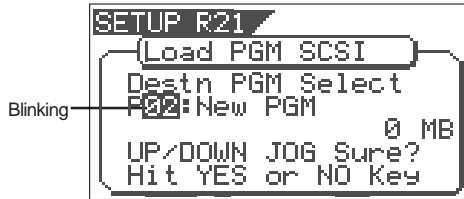

You can select any existing program available on the current drive by rotating the [JOG] dial besides "New PGM".

When selecting an existing program, the data size of the current program is also shown.

When you select load data to an existing program, the backup data overwrites the existing data.

If you do not like any track to be overwritten, select "New PGM".

<Note>

If the current drive disk (destination disk of loading data) does not have enough available space for accepting the loaded data, The display shows "Disk Full" and the returns to the screen shown when carrying out step 3.

- 4** Use the [JOG] dial to select the load destination program and press the [ENTER/YES] key.

The data load to the selected program starts.

The display changes to something like the screen below. As the data load goes on, the remaining data size shown on the screen counts down.

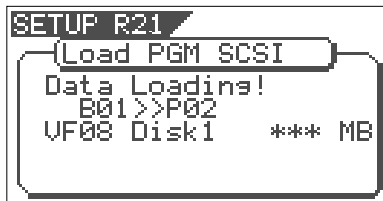

After completing the data load from Disk-1, the display shows "Insert Disk 2", while Disk-1 is automatically ejected.



- 5** Insert Disk-2 (the second disk) to the SCSI device according to the display message.

In a while after inserting the disk, the VF08 automatically starts loading data from Disk-2. The screen looks similar to the one when loading Disk-1. As the data load goes on, the remaining data size shown on the screen counts down.

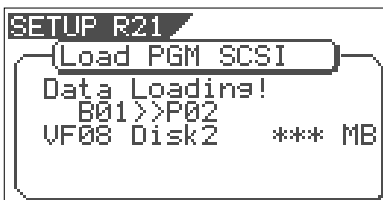

When the load operation is completed, "Completed!" appears, while the VF08 stops.

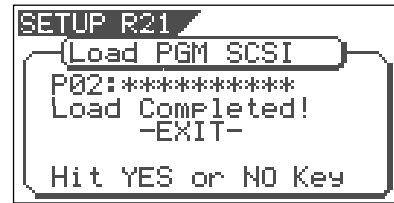

<Note>

You cannot abort the load operation using SCSI before completed, unlike the load operation using the S/PDIF signal.

- 6** Press the [EXIT/NO] key (or the [STOP] key) repeatedly until exiting the setup mode.

Save/load a WAV file

Song data can be saved to or load from a SCSI disk by the FDMS-3 (Fostex Disk Management System-3) format, as well as by the WAV file format (RIFF WAVE file format) using a DOS-formatted disk. As you can handle song data of the VF08 with a WAV file, it is possible to directly import/export data from/to a personal computer, to playback/edit a data file with various software applications, and to import a data file edited by a computer to the VF08.

<Important notes for using a WAV file>

About backup disks:

- The save/load by a WAV file can be done only by using a disk DOS-formatted with FAT16. The VF08 executes the save/load of a WAV file when it recognizes the disk DOS-formatted with FAT16. The VF08 cannot recognize a disk DOS-formatted with FAT32.
- You cannot DOS-format a disk from the "Disk Format?" menu in the setup mode. A backup disk that handles WAV files must be DOS-formatted with FAT16 by a personal computer in advance. When a disk larger than 2 GB is DOS-formatted with FAT16, the disk is partitioned at the 2 GB maximum size. In such a case, the VF08 only recognizes the first partition and does not recognize the following partition(s). Therefore, the maximum available size of a backup disk for the VF08 is 2 GB. To avoid an accidental erasure of data by overwriting, etc., we suggest to use a clean disk just formatted for the save/load of WAV files.

About directory of a backup disk:

- A WAV file saved is recorded in the root directory (in the first layer) on the backup disk.
- A WAV file that can be loaded must be allocated in the root directory on the backup disk. A WAV file moved from the root directory to another area such as a folder cannot be recognized by the VF08, which may cause a malfunction.

About file names of WAV files

- A WAV file the VF08 saves is recorded with a file name "*****##.WAV".
- A WAV file the VF08 can load must have a file name "*****##.WAV". The first 6 characters "*****" are the title that is shown in the "Title Edit" screen in the setup mode. These characters can be changed when saving using a WAV file or edited by a computer. The following 2 characters "##" indicate the track number (1 to 24) for the save/load using a WAV file. The last ".WAV" is the file extension indicating that the file format is WAV. The VF08 does not recognize other file names than above. See the following description for each operation about details. By using the specifications above, you can load only the desired tracks of a WAV file or load a track-swapped WAV file. See "Loading a WAV file" described later for details.

Saving a WAV file

You can save a WAV file.

Make sure that the DOS-formatted disk with FAT16 is set. The following procedure assumes that the newly formatted "clean" disk is used for backup.

- 1 Press the [SETUP] key to enter the setup mode. The display shows the screen for selecting the Setup menu.
- 2 Use the [JOG] dial to select "Save PGM" and press the [ENTER/YES] key. The display shows the screen for selecting the device to which the data is saved. "SCSI" blinks.

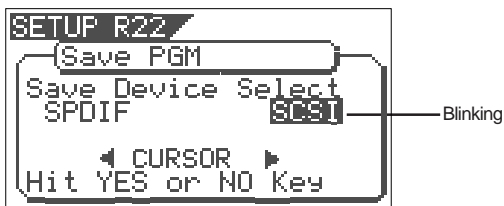

- 3 While "SCSI" is blinking, press the [ENTER/YES] key. The display shows the screen for selecting the backup mode (FDMS 3 or WAV), where "WAV" blinks. (When a DOS-formatted disk is set, "WAV" initially blinks.)

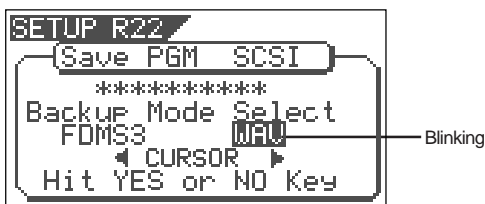

- 4 While "WAV" is blinking, press the [ENTER/YES] key. The display shows the screen for selecting On or Off of the Edit Source Export function, where "Off" blinks. You can switch between On and Off by using the [CURSOR] keys.

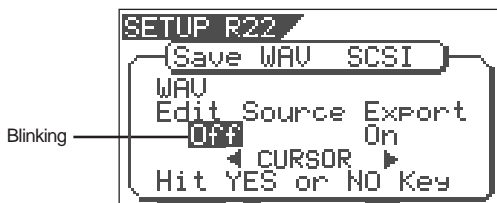

If you save all data from "ABS 0" to "REC END" (in most cases), you do not have to change the setting here.

<About the Edit Source Export function>

The Edit Source Export function allows you to save the desired range of data between the Start and End points which are set when executing the Copy-paste or Move-paste function.

Therefore, if you want to save only the specific range of data, you have to register the Start and End points before the save operation.

See "Track Editing" in "Recorder Function" for details about how to set the Start and End points.

<Note>

If you save all data from "ABS 0" to "REC END", make sure to set the Edit Source Export function to Off.

- 5 While "Off" is blinking, press the [ENTER/YES] key. The display shows the screen for selecting a program to be saved. The program number currently selected blinks, while the data size of the program is shown.

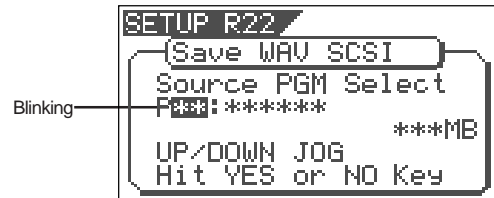

- 6 Use the [JOG] dial to select a program to be saved and press the [ENTER/YES] key. The display shows the screen for selecting a track to be saved. Initially, "All Track" blinks.

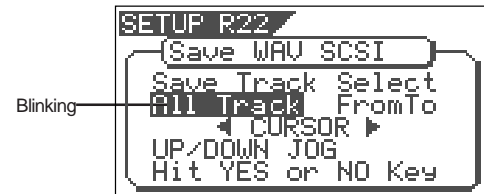

By rotating the [JOG] dial, you can select "From ** To ***" (where the left field blinks initially) instead of "All Track".

If you save data for all tracks (1 through 24), select "All Track". If you save data for any specific track(s), select "From ** To ***" and specify the desired track numbers.

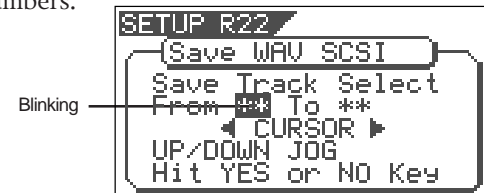

<To specify the desired tracks to "From ** To ***">

By rotating the [JOG] dial while the left ("From") field is blinking, you can select the track number from 01 through 24. The number in the right ("To") field automatically follows the number in the left field (i.e. numbers in the left and right fields are always the same). Therefore, if you want to save a single track, you just have to set the right ("From") field and do not have to set the right ("To") field. For example, "From 02 To 02" will save only track 2.

To specify tracks 5 through 12:

- Enter "05" to the left field while the left field is blinking.
- Press the [CURSOR </>] key to make the right field blinking.
- Enter "12". (Note that the number for the right field must be equal to or larger than the left field.)

Finally the screen shows "From 05 to 12" to save tracks 5 through 12.

Save/Load of Song data

- 7** After selecting the track(s), press the [ENTER/YES] key.

The display shows the screen for selecting a WAV file on the disk.

If no file is recorded on the disk, "New File" blinks.

You can select "Eject" by rotating the [JOG] dial.

To remove the disk, select "Eject" and press the [ENTER/YES] key.

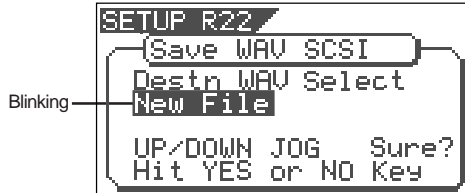

<Hints>

If the backup disk contains any existing program(s) previously saved, the display may show following screens after carrying out the previous step, depending on the available space of the backup disk.

•Showing the title and "New File":

There is enough space for creating a new WAV file in addition to the existing WAV files on the disk.

Pressing the [ENTER/YES] key advances to the next step (for editing the file name).

After completing the save operation, this new WAV file will be added on the disk.

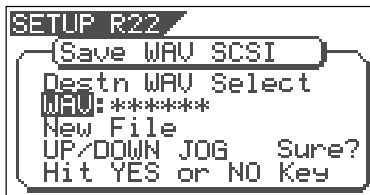

•Showing the title and "New File", and "-****MB" alternately:

The space for adding a new WAV file to the existing WAV files on the disk is ****MB short.

Pressing the [ENTER/YES] key shows "Disk Full!", followed by "Delete All WAV?".

Pressing the [ENTER/YES] key again deletes all the WAV file on the disk and advances to the next step (for editing the file name)

After completing the save operation, only this new WAV file will remain on the disk.

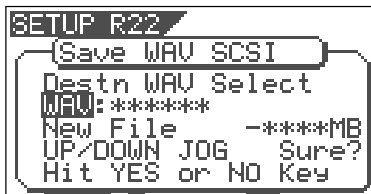

•Showing the title and "****MB":

To get enough space for creating a WAV file, the specified file on the backup disk will be deleted.

By pressing the [ENTER/YES] key, "DEL" appears.

Pressing the [ENTER/YES] key again will delete the specified WAV file on the disk and advances to the next step (for editing the file name).

After completing the save operation, the specified WAV file will be replaced with the new WAV file on the disk.

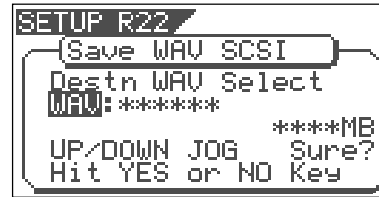

•Showing the title and "-****MB":

Even if the specified file is deleted, the space for creating a new WAV file on the disk is ****MB short.

Pressing the [ENTER/YES] key shows "Disk Full!", followed by "Delete All WAV?".

Pressing the [ENTER/YES] key again deletes all the WAV file on the disk and advances to the next step (for editing the file name).

After completing the save operation, only the new WAV file will remain on the disk.

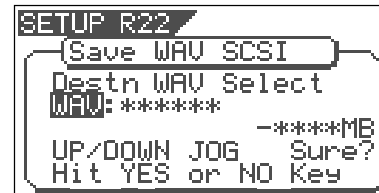

- 8** After selecting a file, press the [ENTER/YES] key. The display shows the screen for editing the WAV file.

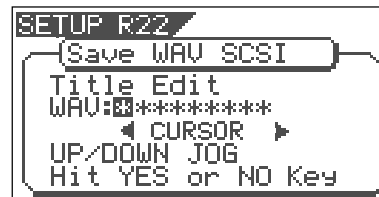

By rotating the [JOG] dial, you can set the desired numeric, symbolic or alphabetical character to the blinking point. You can move the blinking point by using the [CURSOR] keys.

See the following table for the available characters.

Upper-case alphabetical characters (A to Z)
 Numerals (0 to 9)
 Symbols (! # \$ % & ' () @ ^ _ -)

<Note>

You can use up to 6 characters for a file name. Some characters entered are converted as shown below.

- Upper-case alphabetical characters (A to Z): not converted
- Lower-case alphabetical characters (a to z): converted to the corresponding upper-case
- Numerals (0 to 9): not converted
- Symbols (! # \$ % & ' () @ ^ _ -): not converted
- Other symbols: converted to "-".

- 9** After entering the file name, press the [ENTER/YES] key.

The save operation is executed and the display shows something like the one as below. As the file save goes on, the remaining data size shown on the screen counts down.

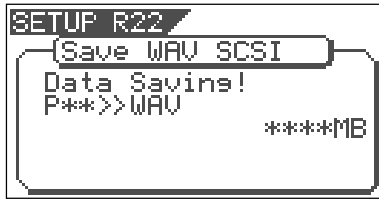

When saving data onto more than one disk, the current disk number is shown on the screen as "Disk*" (where * indicates the number).

Immediately after the data save to each disk is completed, the disk is automatically ejected, and "Insert Disk*" blinks on the screen, prompting you to insert the next disk.

Inserting the next disk resumes the save operation.



After the save operation is completed, "Completed!" appears on the screen.

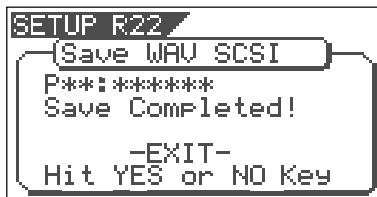

<Hint>

In the save operation which requires more than one backup disk, if you use a backup disk which contains any program(s) saved, the display shows the screen as shown below.

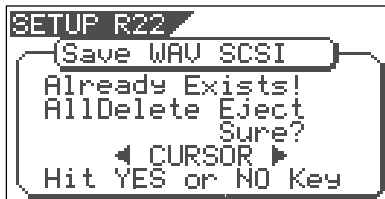

This screen is asking you whether to delete all existing WAV files on the disk or to eject the disk. To delete all the existing files, select "All Delete" and press the [ENTER/YES] key. All existing files are deleted and the disk is ready for saving data. If you do not want to delete the existing files, select "Eject" and press the [ENTER/YES] key. The disk is ejected so you can insert another disk. To select between "All Delete" and "Eject", press the [CURSOR] key.

10 Press the [EXIT/NO] key (or the [STOP] key) repeatedly until exiting the setup mode.

<About WAV files saved>

•WAV file structure

A WAV file on the backup disk has 24 files (one file per track) in the root directory of the disk.

The file names are "*****01.WAV" through "*****24.WAV" where "*****" shows the file name specified in step 8 above and each number (01 - 24) shows the corresponding track number.

If a track has no data recorded, the corresponding file with no data is created.

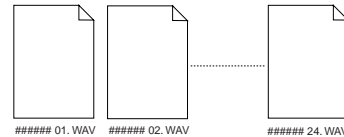

•WAV file structure which is saved over more than one disk

A WAV file is saved in order of track number (from tracks 1 to 24).

During the save operation over more than one backup disk, the VF08 always calculates the available space of the disk automatically. If the VF08 knows that the available space gets smaller than the data size of the next track, it will change the disk when the data save of the current track is completed.

•WAV file size

When saving data by the WAV file format to a backup disk, the file size may sometimes increase compared with the data size in the current drive, depending on the recorded data condition such as the start time, end time, the data amount, etc. on each track.

For example, if a track is recorded from ABS:0 (min.) to ABS:1 (min.) and ABS:10 (min.) to ABS 11 (min.), the file on the current drive has a length of 2 minutes, while the WAV file has a length of 11 minutes.

Also as mentioned above, if a track has no data recorded, the corresponding WAV file with no data is created though the size is small.

<Notes>

•If the file name you are going to save duplicates with the existing WAV file name on the backup disk, "Warning! Already Exist" is shown on the screen and the save operation will not be executed. In such a case, change the file name according to the procedure above and carry out the save operation again.

•A disk on which you have overwritten data many times may lower the access speed because of the disk fragmentation. Therefore, we suggest that you should use a newly formatted "clean" disk for backup.

•If any other file but "*****##.WAV" or folder, which cannot be recognized by the VF08, is created on the backup disk using a personal computer, the VF08 cannot calculate the available backup disk space accurately. Accordingly, it may happen that the save operation cannot be completed. You should note this when changing the file name or creating a folder using your computer.

Save/Load of Song data

Loading a WAV file

- 1 Press the [SETUP] key to enter the setup mode.
The display shows the screen for selecting the Setup menu.
- 2 Use the [JOG] dial to select "Load PGM" and press the [ENTER/YES] key.
The display shows the screen for selecting the device from which the data is loaded. "SCSI" blinks.
- 3 While "SCSI" is blinking, press the [ENTER/YES] key.
The display shows the drive name and "DOS Format", followed by the screen for selecting the WAV file to be loaded, showing the WAV file name and size.
If no disk is inserted, "No SCSI Disk!" is shown.

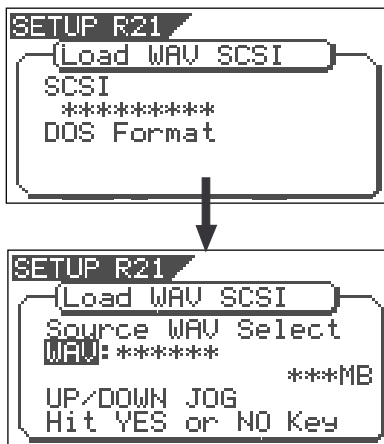

- 4 Use the [JOG] dial to select the desired WAV file to be loaded.
If more than one WAV file with different file names (the first 6 characters) is saved, you can see each file name (by the first 6 characters) in order when rotating the [JOG] dial. You can also select "Eject" to remove the backup disk.

<Note>
The VF08 cannot recognize any other file names but "*****#.WAV" and cannot load such disks. A WAV file with a unique name (the first 6 characters) is recognized as an independent backup file and can be selected.

- 5 After selecting the desired WAV file, press the [ENTER/YES] key.
The display shows the screen for selecting a track to be loaded.
"All" blinks initially.
Besides "All", you can select any one of tracks (01 through 24) by rotating the [JOG] dial.

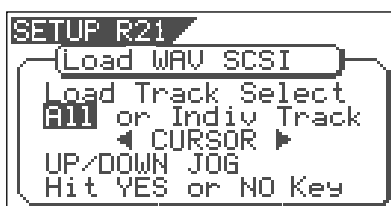

- 6 After selecting the desired track(s), press the INTER/YES key.

The display shows the screen for selecting the load destination program to which a WAV file is loaded. You can select the program by using the [JOG] dial.

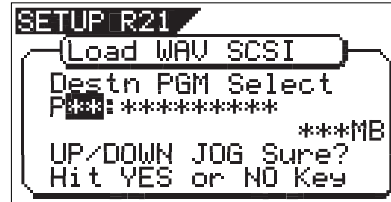

When the screen shows "Title" and "Size", the selected program will be deleted and replaced with the WAV file loaded.

When the screen shows "Title" and "New PGM", the WAV file loaded will create a new program.

<Note>

If the current drive does not have enough available space for loading the WAV file, the size indication on the screen shows a negative value ("-***"). In such a case, select a program that can be replaced with the WAV file loaded without causing the disk space shortage, or delete unnecessary programs by the "Delete PGM" menu in the setup mode.

- 7 After selecting the load destination program, press the [ENTER/YES] key.

When selecting a new program as the load destination (by selecting an option showing "Title" and "New PGM"), the load operation immediately starts.

When selecting an existing program as the load destination (by selecting an option showing "Title" and "Size"), "Overwrite?" and "Sure?" appear. Pressing the [ENTER/YES] key will start the load operation. During the load operation, the screen shows something like the one as below.

As the data load goes on, the remaining data size shown on the screen counts down.

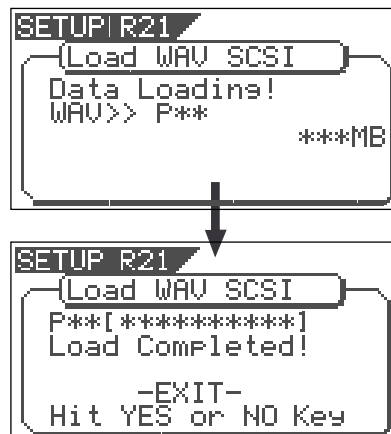

When the load operation is completed, "Completed!" appears on the screen.

<Note>

The title of the program to which the WAV file is loaded is replaced with the WAV file name loaded (the first 6 characters).

- 8 Press the [EXIT/NO] key (or the [STOP] key) repeatedly until exiting the setup mode.

To go back to the previous step or abort the operation, you can also use the [EXIT/NO] key or the [STOP] key.

<< Special loading method when using a computer >>

< Note >

WAV files which can be saved/loaded by this recorder must have file names written as "*****##.WAV."
Other file names cannot be acknowledged by this recorder.

Unknown file names will not be acknowledged and could cause malfunction. Extreme care should be taken when changing file names and making folders on a computer.

- * The first six letters will be the title shown in the SETUP mode "Title Edit" display.
- * The last two letters "##" represent each track number (1-24) of the WAV file which are to be saved/loaded.
- * The last "WAV" is the extension which indicate that this is a WAV file.
- * File name of the WAV file which is to be saved in the backup disk of this recorder will all be recorded in capital letters. However, in certain computers, this WAV file name will be displayed in small letters.

(* Method to load specific tracks.

The backup disk in which files are saved will contain files from "*****01.WAV" up to "*****24.WAV." Should these files be deleted, moved from the root directory, for example, into a another folder or the file name changed which cannot be acknowledged, this recorder will not recognize this file.

When a backup disk changed in this manner is loaded, only WAV files with file names "*****##.WAV" which are located in an acknowledgeable root directory can be loaded.

For example, if the "zero number of data" made at save is deleted from the backup disk and then load is executed, only WAV files recorded with any other sound can be loaded.

(* When loading WAV files saved in a multiple number of disks, they can be loaded by a special method derived from the above method.

Assume that there is backup disc 1 saved with "*****01.WAV" through "*****12.WAV" and disc 2 saved with "*****13.WAV" through "*****24.WAV."

First, when backup disk 1 is loaded, files in tracks 1-12 will be loaded. At this point, tracks 13-24 will not be loaded and thus be non-recorded. Next, when backup disk 2 is loaded, files in tracks 1-12 remains intact and tracks 13-24 only will be loaded.

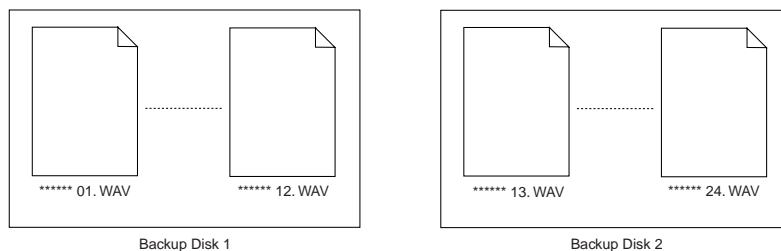

(* Method in loading by changing the track.

If the two letters "##" in file name "*****##.WAV" in the backup disk are changed, it will be possible to load them on this recorder on a track different from that at the initial save. For example, if a WAV file named "ABCDEF01.WAV" on track 1 is changed to "ABCDEF03.WAV" this WAV file will be loaded on track 3.

(* Method in loading by changing the title.

If the 6 letters "*****" in file name "*****##.WAV" in the backup disk are changed, it will be possible to load them on this recorder under a title different from that at the first save. Letters which can be used at changing the file name in a computer are those only indicated below. All of these letters must be one byte size.

Alphabets	: A-Z and a-z
Numerals	: 0-9
Symbols	: !#\$%&'()@'_ =

SETUP mode

The SETUP mode of the VF08 offers the “Changing the initial settings” menus, which configure the operating environment of the VF08, a “Check” menu that enables you to check the number of events for each track, and an “Execution” menu that executes certain operations, such as save and load and disk formatting. The “Changing the initial settings” menu include 16 parameters as shown in <Table-1> below. These parameters were set before the VF08 was shipped from the factory and these values are called the “initial settings.” Modifying these settings allows you to change the operating environment of the VF08. The “Check” menu provides two parameters “Checking the number of events” as shown in <Table-2> - “Checking the number of events” and “Checking the current drive information.”

Also, as shown in <Table-3>, the “Execution” menus include three items: Load PGM, Save PGM, and Disk Format, which you can execute by selecting the corresponding SETUP menu. This chapter explains how to use the “Changing the initial settings” menus shown in <Table-1> and the “Check” menu shown in <Table-2>.

For more information on the “Execution” menus, refer to the corresponding pages in the “Reference page” column in <Table-3>.

<Table-1> “Changing the initial settings” menu

Parameters	Display	Default setting	Refer page	Community
Setting a time signature	Signature Set	001BAR 4/4	99	○
Setting a tempo	Tempo Set	001BAR 1♩120	101	○
Setting the metronome function	Click ↓	Off	102	○
Setting MIDI sync output signal	Midi Sync Out	MTC	103	○
Setting an MTC frame rate	Frame Rate	25 frame	103	○
Setting an MTC offset value	Mtc Offset	00h 59m 57s 00f 00sf	104	○
Setting the offset mode	Offset Mode	ABS	104	○
Setting the slave mode	Slave Mode	Off	105	○
Setting the slave type	Slave Type	Vari	105	○
Setting the record protect function	Rec Protect	Off	106	○
Setting digital input	Digital In	Off	107	●
Setting BAR/BEAT resolution mode	↓Resolution	Off	107	●
Setting the MIDI device ID number	Device ID	00	108	●
Setting the drive	Drive Select	IDE	109	-
Setting the fader fix mode	Fader Fix	Off	110	○
Setting the fader recall mode	Fader Recall	Off	110	○

○: Modes applicable program by program. They can be saved/loaded.

●: Modes applicable to all program. They cannot be saved/loaded.

<Table-2> “Check” menu

Check item	Display	Refer page	Community
Check of the event number on the track	Number Of Event	108	-
Check of the current drive information	Drive Information	109	-

<Table-3> “Execution” menu

Execution item	Display	Refer page	Community
Saving song data to an external device	Load PGM	80	-
Loading song data from an external device	Save PGM	80	-
Formatting an current drive disk	Disk Format	18	-

To enter the SETUP mode

Entering the SETUP is possible only when the VF08 is in the Stop mode.

- 1 While the recorder is stopped, press the [SETUP] key on the operating panel.

When the [SETUP] key is pressed, the recorder enters the SETUP mode first stage and change to the display for selecting the SETUP menu. The white black reversed title indicates the currently selected menu and the ▼ (flash) indicates that other titles exist below.

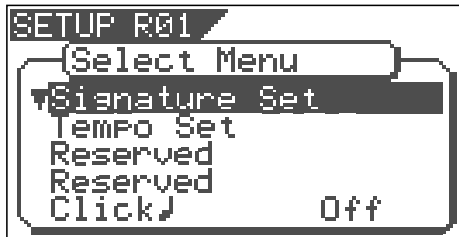

<Note>

At shipping from the plant or when power is switched on again, the "Signature Set" menu will be reversed in white-black. Otherwise, when exiting from the SETUP mode, the SETUP menu that was displayed last will be reversed in black and white.

- 2 If the desired menu is selected via the [JOG] dial and the [ENTER/YES] key pressed, you can proceed to the actual setup procedure.

<Important>

- * To exit from the SETUP mode or return to the previous level, press the [EXIT/NO] key (or [STOP] key).
- * When selecting the desired SETUP menu, the [CURSOR] keys can be used in addition to the [JOG] dial.

Time signature setting ["Signature Set"]

Using the "Setting a time signature" menu, you can set a time signature of a given measure on the internal programmable Tempo Map. Also in this setting, the BAR (-002BAR, 1, 00CLK) displayed at the head of the disk in the time base BAR/BEAT/CLK can be set within a range of -009BAR ~ -002BAR.

For example, you can specify 4/4 for the first and second measures, and 2/2 from the third measure."

Setting a time signature and tempo will create a Tempo Map, which allows the VF08 to manage a song using the BAR/BEAT/CLK Time Base. You can also use the Metronome function.

A time signature and tempo setting are required when MIDI clock & song position pointer are output to an external sequencer.

- * Initial Setting : 001bar 4/4 beat
- * Available bars : 001 ~ 999
- * Available time signature : 1/4, 2/4, 3/4, 4/4, 5/4, 1/8, 3/8, 5/8, 6/8, 7/8, 8/8, DEL
- * Maximum setting points : 64
- * The setting is applicable song by song.
- * The setting can be saved or loaded as a part of the song data
- * The setting is memorized even when the power is off.
- * Make sure you choose the right program before setting this mode.

- 1 Select a program for which to set a time signature.
- 2 In the menu selecting display, select "Signature Set" and press the [ENTER/YES] key.

The display will change to confirming the currently set signature. In the initial setting, the display will be as shown below to indicate that the bar offset is -002BAR, signature from the first bar is set to 4/4, and nothing is set after the first bar.

If the [JOG] dial is rotated, items displayed can be alternately selected. "-002BAR Offset" to setup the bar offset figure, "Insert New Event" to setup a new signature following the first bar, and "All Clear" to clear all signature/tempo settings, can be selected.

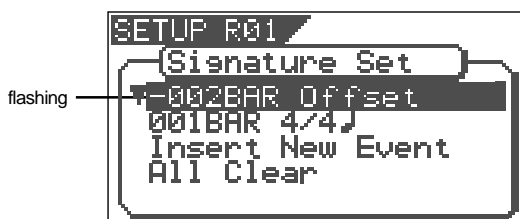

New Registering of Time Signature

- 3 While in the previous step 2 display, select "Insert New Event" and press the [ENTER/YES] key. The "Insert New Event" display section will change to the display for setting up a new bar and the "002" number will flash. At this point, the bar figure displayed will be the bar figure setup last +1 and the signature figure displayed will be same as the last setting (Example: In the initial state, "002BAR 4/4" will be shown.

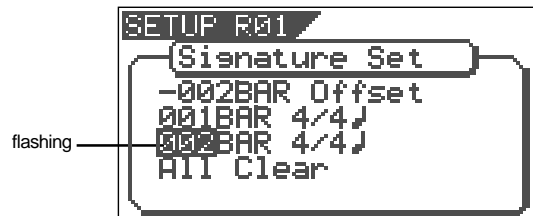

- 4 Input the desired bar figure with the [JOG] dial and press the [ENTER/YES] key. It will change to flashing of "4/4."

- 5 Input the desired meter via the [JOG] dial and press the [ENTER/YES] key. The input bar and signature figures will be set as shown in the following. This display is an example of setting the third bar to 3/4 beat. If the [JOG] dial is rotated, the editing point of bar or signature, like the figures shown below, can be input.

SETUP mode

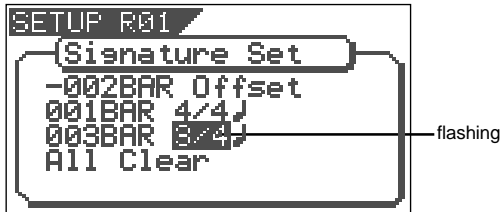

The following bar numbers and time signatures can be entered via the [JOG] dial.

Bar	You can enter are from 001 to 999.
Time Signature	1/4, 2/4, 3/4, 4/4, 5/4, 1/8, 3/8, 5/8, 6/8, 7/8, 8/8 or DEL "DEL" is used to deleted time signature data.

- Next, to register other bar and time signature, repeat steps 2 through 5.
- Upon completion of registering, press the [EXIT/NO] key (or the [STOP] key) and exit from the SETUP mode.

Correcting the Registered Time Signature

- Under the previous "Confirmation display," select bar/time signatures to be changed and press the [ENTER/YES] key.
- Input the desired signature via the [JOG] dial and press the [ENTER/YES] key.
The newly input signature will be setup.

Time Signature	1/4, 2/4, 3/4, 4/4, 5/4, 1/8, 3/8, 5/8, 6/8, 7/8, 8/8 or DEL "DEL" is used to deleted time signature data.
----------------	--

- Upon finishing, press the [EXIT/NO] key (or [STOP] key) to exit from the SETUP mode.

Deleting a Time Signature

- Under the above "Confirmation display," select bar/time signatures to be deleted and press the [ENTER/YES] key.
- Press the [ENTER/YES] key again to make "*/ *" to flash and input "DEL" via the JOG dial.

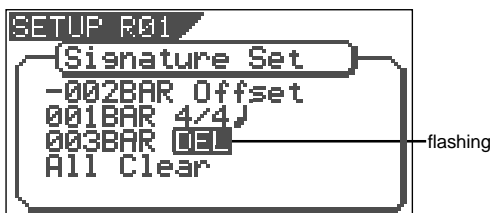

- Press the [ENTER/YES] key.
The selected measure/signature setting will be deleted.
- After deleting, press the [EXIT/NO] key (or [STOP] key) to exit from the SETUP mode.

<Note>

You cannot register the "001BAR" of "001BAR 4/4."

<Note>

Take care because this procedure wipes out the tempo setting as well as time signature setting.

Clearing All Time Signature/Tempo Data

<Note>

Be careful because this procedure wipes out the tempo setting as well as time signature setting.

- Under the above "Confirmation display," select "All Clear" and press the [ENTER/YES] key.
A following display of "All Clear," "SURE?" will flash. This indicates the standby mode for clearing all signature setting data and the tempo data.

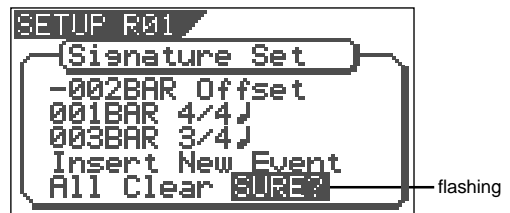

- Press the [ENTER/YES] key.
Except for the initial setting "001BAR 4/4," other time signature settings and the tempo setting will be cleared at the same time.
- Press the [EXIT/NO] key (or STOP key) to exit from the SETUP mode.

Changing the Bar Offset Figure

- Under the above "Confirmation display," select "-002BAR Offset" and press the [ENTER/YES] key.
The "-002" display will change to flashing.

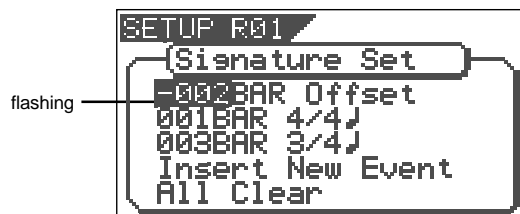

- Input the desired offset value with the [JOG] dial and press the [ENTER/YES] key.
Offset value can be input in the -2 through -9 range.
- After correction, press the [EXIT/NO] key (or [STOP] key) to exit from the SETUP mode.

Setting a tempo ["Tempo Set"]

The "Tempo Map Set" menu enables you to specify a tempo at a given point in a song that already has a time signature setting. For example, you can specify a tempo of 150 to the third beat of the 12th measure. Time signature and tempo settings make a Tempo Map, which is used by the VF08 to manage the song using the BAR/BEAT/CLK time base, and enable the metronome function. Tempo settings as well as time signature settings are required when you wish to output MIDI clock and Song Position Pointer to an external sequencer.

<Note>

The tempo set figure setup here is an approximate figure and thus not accurate. Therefore, although the tempo map be matched with a personal computer, they will gradually drift apart. In order to prevent this drift, the personal computer side can be set to either MIDI clock sync or, the MIDI sync output signal temporarily set to "MIDI Clock" the figure reset to make it possible for the computer to read the accurate tempo, and the return it again to MTC sync.

- * Initial Setting: 001BAR 1st beat 120 bpm
- * Bar to register: Follows to the time signature setting
- * Beat to register: Follows to the time signature setting
- * Available tempo: 30 ~ 250, DEL (delete)
- * Maximum setting points:64
- * The setting is applicable song by song.
- * The setting can be saved or loaded as a part of the song data
- * The setting is memorized even when the power is off.
- * Make sure you choose the right program before setting this mode.

- 1 Select a program for which to set a tempo setting.
- 2 Under the menu selection display, select "Tempo Set" and press the [ENTER/YES] key.
The display will change, confirming the current tempo setting. At the initial setting, the display will be as shown below, indicating that tempo of the first beat for the 001 bar is 120 and subsequent tempo is not setup. "Insert New Event" should be selected at setup of a new tempo. When the [JOG] dial is rotated, the currently displayed items can be selected alternately.



- 2 Input the desired bar with the [JOG] dial and press the [ENTER/YES] key.
The bar value that can be input is identical with the above "signature setup." When the [ENTER/YES] key is pressed, "beat value" will change to flashing.
- 3 Input the desired beat with the [JOG] dial and press the [ENTER/YES] key.
The meter value that can be input is identical with the above "signature setup." When the [ENTER/YES] key is pressed, "tempo value" will change to flashing.
- 4 Input the desired tempo with the [JOG] dial and press the [ENTER/YES] key.
The tempo can be input within the range of 30 through 250. When the [ENTER/YES] key is pressed, the tempo map value thus input will be set and return to the above mentioned "Confirmation display for tempo map."
- 5 To register another tempo map, repeat steps 1 through 4.
- 6 Upon completing registering, press the [EXIT/NO] key (or [STOP] key) to exit from the SETUP mode.

For a setup example, if it is attempted to setup the following tempo in the music that is set to [001BAR 4/4 ♩] and [005BAR 3/4 ♩] by the previous "signature setup," as seen in the music score below, the tempo

New Registering of Tempo

- 1 Under the above "Confirmation display," select "Insert New Event" and press the [ENTER/YES] key.
The "Insert New Event" section will change to new tempo setup display and "002" will flash. The bar value thus displayed will be the last setup bar value + 1 and tempo value will be identical with the last setting (Example: In the initial setup state, "002BAR 1 ♩ = 120" will be displayed.

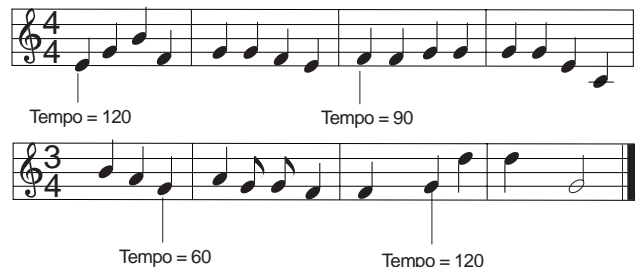
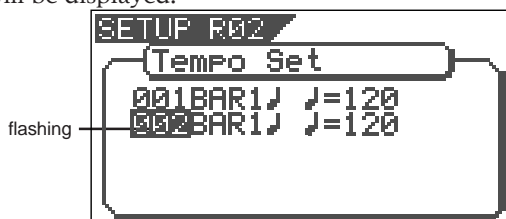

Tempo Map	
Time signature setting	Tempo setting
001 BAR 4/4 ♩	001 BAR 1 ♩ = 120 003 BAR 1 ♩ = 90
005 BAR 3/4 ♩	005 BAR 3 ♩ = 60 007 BAR 2 ♩ = 120

SETUP mode

Correction of the Registered Tempo

- 1 Under the above “Confirmation display,” select the tempo map which is to be changed and press the [ENTER/YES] key.
The same as before, “tempo value” will flash.
- 2 Input the desired tempo with the [JOG] dial and press the [ENTER/YES] key.
- 3 Upon completing registering, press the [EXIT/NO] key (or [STOP] key) to exit from the SETUP mode.

Erasing of the Registered Tempo

- 1 Under the above “Confirmation display,” select the tempo map which is to be erased and press the [ENTER/YES] key.
The same as before, “tempo value” will flash.



- 2 Input the “DEL” with the [CURSOR >] key, and then press the [ENTER/YES] key.
The selected tempo map will be erased.
- 3 Upon completing registering, press the [EXIT/NO] key (or [STOP] key) to exit from the SETUP mode.

<Note>

You cannot register the “001BAR 1 J=120.”

Setting the Metronome function [“Click”]

“Setting the Metronome function” menu allows you to determine whether or not the VF08 outputs a metronome sound from track 6 during playback or recording. Turning the Metronome function on enables you to record your performance while playing the instrument accompanying the metronome sound.

<Note>

Metronome sound will be output from track 6.

For this reason, when the metronome function is activated, a new sound source cannot be recorded on the track to which the metronome sound is to be output or sound recorded on this track cannot be played back. If the metronome function is not to be used, be sure to reset it to “Off.”

- * Initial Setting : [Off]
- * Available setting : [Off] or [On]
- * The setting is applicable song by song.
- * The setting can be saved or loaded as a part of the song data
- * The setting is memorized even when the power is off.
- * Make sure you choose the right program before setting this mode.

- 1 Select “Click” in the menu selection display and press the [ENTER/YES] key.
The currently set item (Off or On) will flash (“Off” will flash if in the initial state).

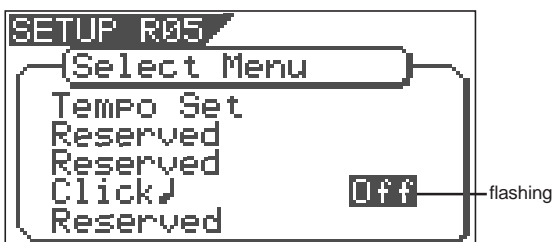

- 2 Select “On” or “Off” with the [JOG] dial and press the [ENTER/YES] key.
The selected item will be setup.

On	Metronome sound will be output from track 6.
Off (default)	Metronome sound will not be output.

- 3 Press the [EXIT/NO] key (or [STOP] key) to exit from the SETUP mode.

Setting MIDI sync output signal ["Midi Sync Out"]

The "Setting MIDI sync output signal" menu enables you to select the type of MIDI sync signals output from the MIDI OUT connector on the rear panel of the VF08 to an external MIDI device.

The options are MIDI clock & Song Position Pointer, or MTC (MIDI time code). Select an appropriate option depending on the type of signal supported by the connected MIDI device.

If you select MIDI clock & Song Position Pointer, first you need to set the time signatures and tempo as described previously. If you select MTC, you first need to set the MTC frame rate, the MTC offset time, and the MTC offset mode as described later.

- Initial setting: [Mtc]
- Option: [CLK] (clock & Song Position Pointer), [MTC] (MIDI time code), or [Off] (no output)
- * You can set the parameters for each Program individually.
- * The settings can be saved and loaded as part of the song data.
- * The settings are maintained after you turn off the power to the VF08.

2 Select the desired MIDI sync signal with the [JOG] dial and press the [ENTER/YES] key.

CLK (Initial setting)	MIDI clock and song position pointer will be output.
Mtc	MIDI time code will be output.
Off	Any MIDI sync signal will not be output.

1 Select "Midi Sync Out" in the menu selection display and press the [ENTER/YES] key. The currently set item will flash. "CLK" will flash in initial setting.

3 Press the [EXIT/NO] key (or STOP key) to exit from the SETUP mode.

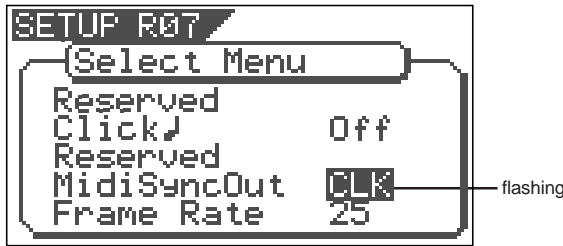

Setting an MTC frame rate ["Frame Rate"]

The "Setting an MTC frame rate" menu enables you to set the frame rate for MTC output from the MIDI OUT connector of the VF08 to an external MIDI device. If you have already set the type of MIDI sync output signal to [MTC], you need to set the frame rate. Use the frame rate of MTC received by the external MIDI device (or sequence software).

- Initial setting: [25] (25 frames)
- Setting range of frame rate: [24], [25], [29df], [29nd], [30df] or [30nd]
- * You can set the value for each Program individually.
- * The settings can be saved and loaded as part of the song data.
- * The settings are maintained after you turn off the power to the VF08.

2 Select the desired frame rate value with the [JOG] dial and press the [ENTER/YES] key. It will be set to the selected frame rate.

3 Press the [EXIT/NO] key (or STOP key) to exit from the SETUP mode.

1 Select "Frame Rate" in the menu selection display and press the [ENTER/YES] key. The currently set frame rate will flash. "25" will flash in the initial setting.

*<Note>
There are no 29.97nd or 29.97df in the MTC standard. Use either 30nd or 30df unless you definitely need to synchronize the VF08 with NTSC video.*

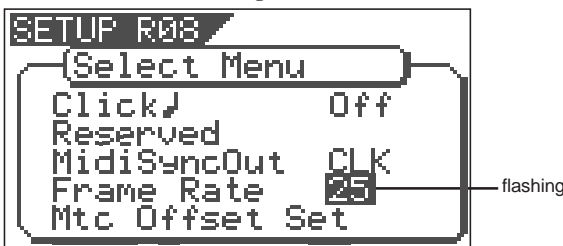

Setting an MTC offset value ["Mtc Offset Set"]

The "Setting an MTC offset value" menu enables you to specify an offset time value - the difference between the time of MTC output from the VF08 and the ABS 00m 00s 00f 00sf time. You need to specify this value if you have selected [MTC] for the "Setting MIDI sync output signal" menu.

With the initial setting of 00h 59m 57s 00f 00sf, for example, MTC of 59m 57s 00f 00sf is output at the ABS time 00m 00s 00f 00sf. You can also set an offset value from the 001bar 1beat 00clk value (bar/beat) on the Tempo Map. Refer to the next section for information on MTC Offset mode.

- Initial setting: [00h: 59m: 57s: 00f: 00sf]
- Setting range of offset time: 00h: 00m: 00s: 00f: 00sf ~ 23h: 59m: 59s: 29f: 99sf
- * You can set the value for each Program individually.
- * The settings can be saved and loaded as part of the song data.
- * The settings are maintained after you turn off the power to the VF08.

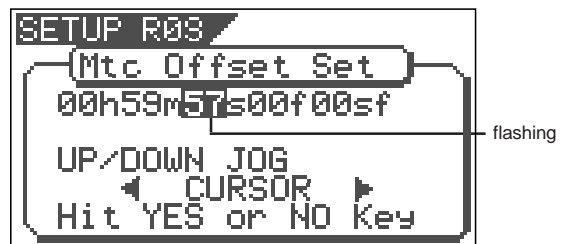

<Note>

For example, if you set MTC Offset mode to "ABS" (See the next section) and you wish to start the song from MTC's 01h 00m 00s 00f, you may wish to set a preroll of three seconds with an MTC offset of 00h 59m 57s 00f.

- 1** Select "Mtc Offset Set" in the menu selection display and press the [ENTER/YES] key.
It will change to the second level display of the [Mtc Offset] menu and the currently set offset value will be shown.
00h 59m 00f 00sf will be displayed in the initial state and "s" will flash. Flashing indicates the editable point.

- 2** Move the edit point with the [CURSOR] key, input the desired offset with the [JOG] dial, then press the [ENTER/YES] key.

Offset value thus input will be set. Advancing or retarding the input figure is carried out automatically with reference to the currently set MTC frame rate figure.

- 3** Press the [EXIT/NO] key (or STOP key) to exit from the SETUP mode.

Setting MTC Offset mode ["Offset Mode"]

If you have selected [MTC] in the "Setting Offset mode" menu, you need to select MTC Offset mode. This menu enables you to determine whether the specified MTC is output at ABS 00h 00m 00s 00f or at 001bar 1beat 00clk (bar/beat) of the Tempo Map.

<Notes>

- * As an example, if you set MTC Offset mode to "ABS" and you wish to start the song from MTC's 1h 00m 00s 00f, you may want to set a preroll of three seconds with MTC offset of 00h 59m 57s 00f.
If you select "BAR" as the MTC Offset mode, a preroll of two measures is automatically set. Use 01h 00m 00s 00f; do not set a preroll value.
- * If you set Offset mode to "BAR" and use MTC to synchronize sequence software on the computer, the tempo of the sequencer may sometimes slip gradually. This is because the tempo of the VF08 and the tempo of the software are slightly different even if both use the same tempo. Some sequence software can read the tempo output from the VF08 correctly. We recommend that you use the tempo of the VF08 on the sequence software. No such problems will occur if the sequence software synchronizes the VF08 via MIDI clock, instead of MTC.

- Initial setting: [ABS]
- Offset mode option: [ABS] or [Bar]
- * You can set the mode for each Program individually.
- * The settings can be saved and loaded as part of the song data.
- * The settings are maintained after you turn off the power to the VF08.

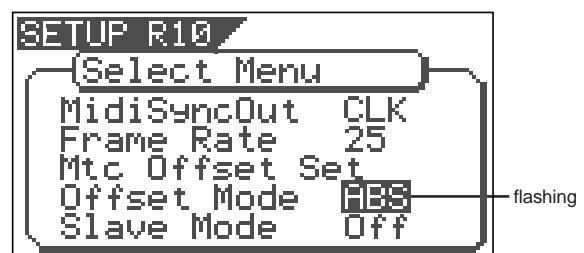

- 1** Select "Offset Mode" in the menu selection display and press the [ENTER/YES] key.
The currently set offset mode will flash. "ABS" will flash in the initial setting.

- 2 Select the desired offset mode with the [JOG] dial and press the [ENTER/YES] key.
The selected offset mode will be set.

[ABS] (Initial setting)	The specified MTC offset time is output at ABS 00h 00m 00s 00f.
[BAR ↓]	The specified MTC offset time is output at 001bar 1beat 00clk of the Tempo Map.

- 3 Press the [EXIT/NO] key (or STOP key) to exit from the SETUP mode.

Setting the Slave mode ["Slave Mode"]

This mode allows you to choose the VF08 slave mode setting either On or Off.

If you set the slave mode to "On", the VF08 will synchronize to the incoming MTC (MIDI Time Code) from master unit. It will also synchronize to a type of external sync signal which you have chosen with the section "Slave Type setting."

- Initial setting: [Off]
- Slave mode option: [On] or [Off]
- * You can set the mode for each Program individually.
- * The settings can be saved and loaded as part of the song data.
- * The settings are maintained after you turn off the power to the VF08.

- 1 Select "Slave Mode" in the menu selection display and press the [ENTER/YES] key.
The currently set slave mode will flash. "Off" will flash in the initial setting.

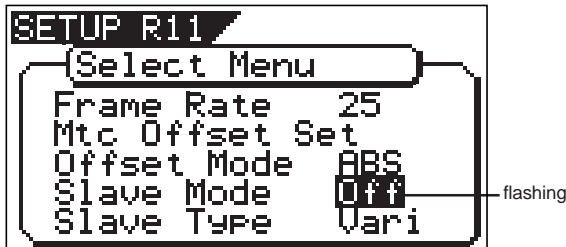

- 2 Select "On" or "Off" with the [JOG] dial and press the [ENTER/YES] key.

- 3 Press the [EXIT/NO] key (or STOP key) to exit from the SETUP mode.

Upon exit from the SETUP mode, the "SLAVE" icon will flash.

This icon will change to constant lighting when VF08 is correctly synchronized with the external equipment.



Setting the Slave Type ["Slave Type"]

If you have set Slave Mode to "On" in the previous section "Slave Mode Setting," you can choose what type of external sync signal that the VF08 synchronizes to. This mode allows you to choose the external sync signal type.

- Initial setting: [Vari]
- Slave type option: [Vari], [Free] or [SPDIF]
- * You can set the mode for each Program individually.
- * The settings can be saved and loaded as part of the song data.
- * The settings are maintained after you turn off the power to the VF08.

<Notes>

- * You need to input MTC from an external device to the VF08 with any Slave Type.
- * The VF08 re-chase window is fixed to ten frames. That is, if an offset between the master device and slave device exceeds ten frames, the VF08 interprets that as out of sync, and tried to chase and lock to MTC sent from the master device. This operation is called "re-chasing." During the re-chase operation, audio output is muted. If the slave machine slips with MTC from the master device by less than ten frames, the slave machine continues running while recognizing the slippage.
- * When you set the Slave Type, the Vari Pitch function is automatically disabled. (The "VARI PITCH" indicator turns off.)

SETUP mode

- 1 Select "Slave Type" in the menu selection display and press the [ENTER/YES] key.
The currently set slave type will flash. "Vari" will be flashing in the initial setting.

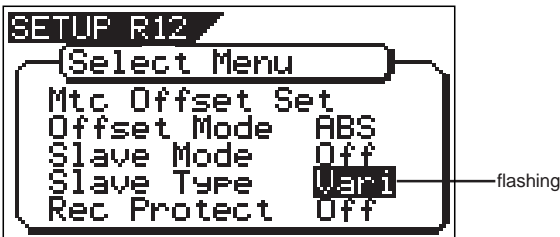

- 2 Select the desired slave type with the [JOG] dial and press the [ENTER/YES] key.
It will be set to the selected slave type.

Free	This is the mode whereby after chase locking, it will free run by the internal clock of VF08 or the digital in clock from the external equipment should the time drift away from that of the master.
Vari (Initial setting)	This is the mode whereby after chase locking, it will constantly run by vari-pitch so that the time does not drift away from that of the master by compensating the phase drift. However, if digital in has been set, it will operate the same as for "Free."
SPDIF	This is the mode whereby after chase locking, it will free run by the S/P DIF clock only when there is S/P DIF digital signals from the master. However, if digital in has been set, that clock will have priority.

- 3 Press the [EXIT/NO] key (or STOP key) to exit from the SETUP mode.

Setting the Record Protect function ["Rec Protect"]

The "Setting the Record Protect function" menu allows you to turn the Record Protection function On or Off. When this function is turned "On", you cannot record, paste, or erase data. Use this function to protect your important data from being accidentally erased.

- Initial setting: [Off]
- Options: [On] or [Off]
- * You can set the mode for each Program individually.
- * The settings can be saved and loaded as part of the song data.
- * The settings are maintained after you turn off the power to the VF08.

<Note>

When recording is disabled ("On") and you try to record, paste, or erase data, the VF08 displays "Protected!" for a second, indicating that you cannot perform the operation. To perform the operation you need to enable recording ("Off").

- 1 Select "Rec Protect" in the menu selection display and then press the [ENTER/YES] key.
The presently set item (On or Off) will flash. "Off" will flash in the initial setting.

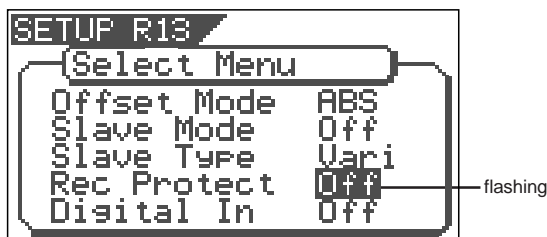

- 2 Select "On" or "Off" with the [JOG] dial and then press the [ENTER/YES] key.
It will be set to the selected item (On or Off).

Selecting "Off" enables recording; you can record, paste, and erase data.

Selecting "On" disables recording; and you cannot record, paste, or erase data.

- 3 Press the [EXIT/NO] key (or STOP key) to exit from the SETUP mode.

Setting Digital Input ["Digital In"]

In the [Setting digital input] menu, whether the signal assigned to tracks 7 and 8 are S/P DIF digital signal analog signals, can be setup.

By using this function, it becomes possible to digitally record from external digital equipment (CD, MD, DAT, adat, digital mixer, etc.).

- Initial setting: [Off]
- Options: [On] or [Off]
- * You can set the mode for each Program individually.
- * The settings cannot be saved and loaded as part of the song data.
- * The settings are maintained after you turn off the power to the VF08.

- 1 Select "Digital In" in the menu selection display and then press the [ENTER/YES] key.
The presently set item (On or Off) will flash.
"Off" will flash in the initial setting.

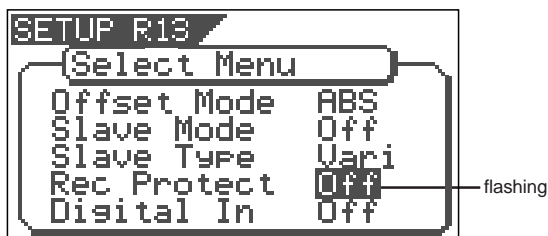

- 2 Select "On" or "Off" with the [JOG] dial and then press the [ENTER/YES] key.
It will be set to the selected item (On or Off).

- 3 Press the [EXIT/NO] key (or STOP key) to exit from the SETUP mode.

<Note>
When setting "Digital In" to "On", "DIGI IN" appears on the Normal screen. While the VF08 receives a valid S/P DIF digital signal from an external digital device and is locked to it, "DIGI IN" steadily lights. While the VF08 does not receive a valid S/P DIF signal, "DIGI IN" blinks. If "DIGI IN" blinks when sending an S/P DIF signal from the external device, check the connection between the VF08 and the external device, as well as the settings (for the digital output, etc) of the external device.

<Note>
When "Digital In" is set to "On", if you enter the bounce, training or mastering mode, the "Digital In" setting is automatically changes to "Off." Therefore, to perform the digital recording after exiting the mode above, you must set "Digital In" to "On" again.

Setting BAR/BEAT Resolution mode ["Resolution"]

The "Setting BAR/BEAT resolution mode" menu enables you to turn BAR/BEAT resolution mode on and off. The initial setting is "Off." When you turn this mode "On", the CLK (clock) digits will be always round off to "00" and be stored in the memory key while the VF08 is using the BAR/BEAT/CLK time base. That is, beat-resolution is used. Using this function allows you to automatically store a beat-resolution value of the IN/OUT points, START/END points and END point in real-time. Therefore, it is very convenient when you perform the Copy & Paste or Move & Paste operation in beat-resolution.

For example, assume that you have stored the value for 001bar 1 46 clk as the START point, and the value for 002bar 4 51 clk as the END point. These values will be used as they are if BAR/BEAT resolution mode is turned off. However, the mode is turned on, the following values will be stored instead. The following example has a time signature setting of 4/4.

001 bar 1 46 clk -> 001 bar 1 00 clk
(A clk value of 46 will be rounded off.)

002 bar 4 51 clk -> 003 bar 1 00 clk
(A clk value of 51 will be rounded up.)

- Initial setting: [Off]
- Options: [On] or [Off]
- * You can set the mode for each Program individually.
- * The settings cannot be saved and loaded as part of the song data.
- * The settings are maintained after you turn off the power to the VF08.

- 1 Select "Resolution" in the menu selection display and press the [ENTER/YES] key.
The presently set item will be flash (On or Off).
"Off" will flash in the initial setup.

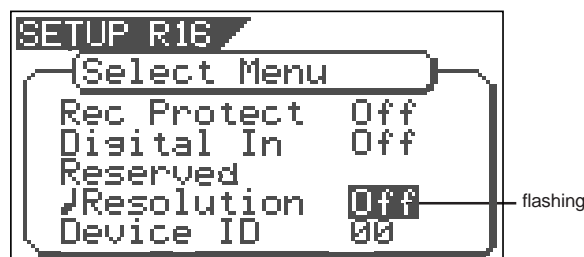

- 2 Select "On" or "Off" with the [JOG] dial and press the [ENTER/YES] key.
- 3 Press the [EXIT/NO] key (or STOP key) to exit from the SETUP mode.

Setting the MIDI device number ["Device ID"]

The "Setting the MIDI device number" menu enables you to set the VF08 device ID number required to control the VF08 from a sequence software using MMC (MIDI Machine Control).

The transmit device ID links to this setting. You can set the device ID from 00 to 99.

However, if the device ID number of the message the VF08 receives is [7F], the VF08 will recognize it to perform the corresponding operation, regardless of its device ID setting.

- Initial setting: [00]
- Options: [00] ~ [99]
- * You can set the mode for each Program individually.
- * The settings cannot be saved and loaded as part of the song data.
- * The settings are maintained after you turn off the power to the VF08.

- 2 Select desired device number with the [JOG] dial and press the [ENTER/YES] key.
- 3 Press the [EXIT/NO] key (or STOP key) to exit from the SETUP mode.

- 1 Select "Device ID" in the menu selection display and press the [ENTER/YES] key.
The presently device number will be flash.
"00" will flash in the initial setup.

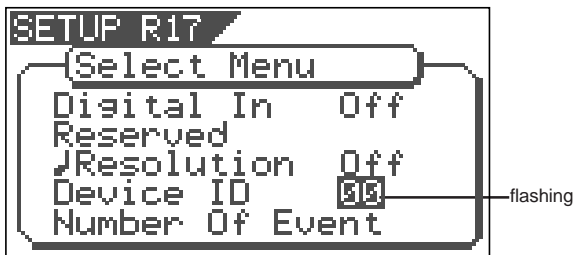

Checking the number of track events ["Number Of Event"]

The "Checking the number of track events" menu enables you to check the number of events on each track. Each track (including Additional tracks) of VF08 Programs consists of consecutive audio files (and "zero" files). The number of events represents the total number of audio files and 0 files. Each track can contain up to 512 events.

If you are editing a song of typical length (about six minutes), repeated editing operation does not usually exceed this maximum number. (Exceeding this limit is called "event number overflow.") Even a 20-minute song will not cause event number overflow. This is because the recorder system always optimizes the data structure by keeping the number of events low. However, if a recording on a track is scattered in different areas of the disk, or if you have made a very long recording on a single track and performed many edits, you should be wary of "event number overflow." To avoid this problem, use the "Checking the number of track events" menu to check the number of events on each track prior to recording or editing.

- 1 Select "Number of Event" in the menu a selection display and press the [ENTER/YES] key.
It will change to the "Event" second level and the event number currently in each track will be displayed (The * symbol indicates there is data below).
*** is the event number.
- 2 Use the [JOG] dial to select another (01~24) to check the number of events on the corresponding track.
- 3 Press the [EXIT/NO] key (or [STOP] key) to exit from the SETUP mode.

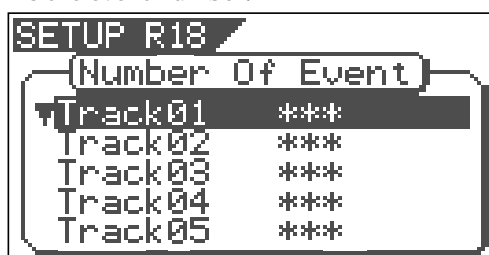

The Drive Format Information ["Drive Information"]

Format information of the current drive currently installed can be checked by using the "Drive Format Information" menu. Should any trouble occur in the VF08, providing the information obtained here to our nearest Fostex Service Station will be of great help in giving quick service. The following items will be displayed and can be confirmed.

1. Manufacture / Model of the currently installed hard disk.
2. Format method
3. Format type
4. Simultaneously recordable number of tracks
5. Number of bits at formatting
6. Sampling frequency at formatting
7. Present number of programs
8. Present number of free blocks
9. Audio file / maximum number of events and its program No.
10. Specific capacity of the drive
11. Remaining capacity of the drive
12. Present software version

- 1 Select "Drive Information" in the menu selection display and press the [ENTER/YES] key. It will change to the "Drive Information" second level and the current drive information currently in use will be displayed (The ▼ symbol indicates there is data below).



- 2 As the [JOG] dial is rotated, information will be displayed one by one.
- 3 Press the [EXIT/NO] key (or [STOP] key) to exit from the SETUP mode.

Drive Setting ["Drive Sel"]

In this "Drive Setting," a switch is made between the current drive (E-IDE hard disk) and the backup drive (Removable SCSI drive). The saved song data can be played back by switching to the backup drive (SCSI). However, this will be only to the extent of confirming the saved data and should all 8 tracks be played back, it may create drop out of sound, and in some SCSI equipment, the channel possible for playback could be changed.

<Note>

The following operations cannot be executed when the drive is switched to "backup drive."

- * Save/load of song data
- * Recording
- * Creating a new program
- * Deleting a program
- * Copy & paste and Move & paste
- * Erase
- * Track exchange
- * Setup of tempo
- * ON/OFF of metronome function
- * Setup of permission or denial of recording
- * Setup of time signature
- * Editing a title

If power to the VF08 is switched again, the drive will automatically switch to current drive (E-IDE).

In order to take out the removable disk when set to backup drive, press the [EXIT/NO] key while holding down the [SHIFT] key.

- Initial setting: [IDE]
- Options: [IDE] or [SCSI]
- * You can set the value for each Program individually.
- * The settings cannot be saved and loaded as part of the song data.

The selected drive will be set. "IDE" indicates the 3.5-inch E-IDE hard disk and, "SCSI" the backup SCSI drive

- 1 Select "Drive Sel" in the menu selecting display and press the [ENTER/YES] key. The present setting will flashes. "IDE" will be flashed in the initial setting.

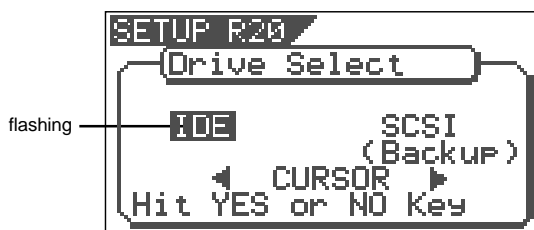

- 1 Press the [CURSOR </>] key, select "IDE" or "SCSI" and press the [ENTER/YES] key.

- 3 Press the [EXIT/NO] key (or [STOP] key) to exit from the SETUP mode.

When the drive is changed, the program number in the Normal screen will shown as indicated below.

When the current drive is E-IDE (program display "P").



When the current drive is SCSI (program display "B").

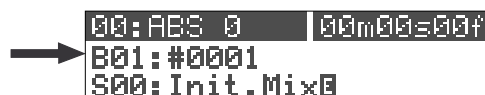

SETUP mode

Fader Fix Mode Setting ["Fader Fix"]

Whether the fader manipulation should be reflected on the sound volume or not can be set. The setup content will be held even if the main power is switched off.

<Caution>

The "Fader Fix Mode" can be made to function when set in other (Track, Master or Trk & Mst) than "Off" of the next item on the "Fader Recall Mode".

- Initial setting: [Off]
- Options: [On] or [Off]
- * You can set the value for each Program individually.
- * The settings can be saved and loaded as part of the song data.
- * The settings are maintained after you turn off the power to the VF08.

- 1 Select "Fader Fix" in the menu selection display and press the [ENTER/YES] key.

The currently set will flash. "Off" will flash in the initial setting.

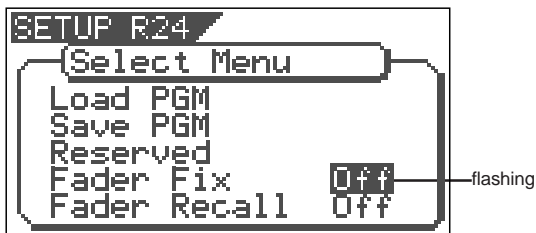

- 2 Select the desired item with the [JOG] dial and press the [ENTER/YES] key. The selected item will be set.

On	For all modes, manipulation of the Track fader/Master fader will have not affect on the sound volume. Any accidental shifting of the fader position by vibration and misoperation can be prevented.
Off (Initial setting)	Manipulation of the Track fader/Master fader will affect the sound volume.

- 3 Press the [EXIT/NO] key (or [STOP] key) to exit from the SETUP mode.

Fader Recall Mode Setting ["Fader Recall"]

In the "Setup of the fader recall mode" menu, whether each track fader/master fader settings should be recalled or not at scene recall, can be setup.

- Initial setting: [Off]
- Options: [Off], [Track], [Master] or [Trk & Mst]
- * You can set the value for each Program individually.
- * The settings can be saved and loaded as part of the song data.
- * The settings are maintained after you turn off the power to the VF08.

- 1 Select "Fader Recall" in the menu a selection display and press the [ENTER/YES] key.

The currently set will flash. "Off" will flash in the initial setting.

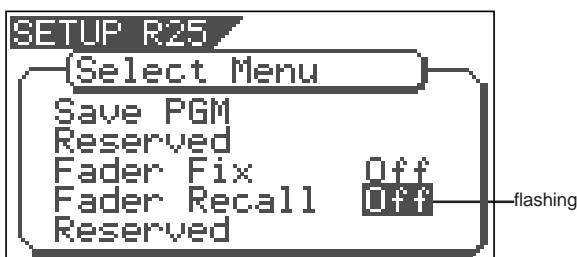

- 2 Input the desired item with the [JOG] dial and press the [ENTER/YES] key. The selected item will be set.

Off (Initial setting)	When scene is recalled, the fader position immediately prior to recalling the scene will be directly employed without recalling the setup figures of each track fader and the master fader.
Track	When scene is recalled, setup figures of each track faders only will be recalled and not recall the master fader setup figure.
Master	When scene is recalled, the setup figure of the master fader only is recalled and the track fader setup figures will not be recalled.
Trk & Mst	When scene is recalled, each track faders and the master fader set up figures will both be recalled.

- 3 Press the [EXIT/NO] key (or [STOP] key) to exit from the SETUP mode.

(Digital Multitracker)

Model VF08

MIDI Implementation Chart

Date:
Version: V1.00

Function.....	Transmitted	Recognized	Remarks
Basic Default	X	X	
Channel Changed	X	X	
Mode Default	X	X	
Message	X	X	
Altered	*****	X	
Note Number:	X	X	
True Voice	*****	X	
Velocity Note ON	X	X	
Note OFF	X	X	
After Touch Key's	X	X	
Channel's	X	X	
Pitch Bend	X	X	
Control Change	X	X	
Program Change True #	X	X	
	*****	X	
System Exclusive	○ (rem. 1)	○ (rem. 2)	
Common : Quarter Frame	○	○	
: Song Position	○	X	
: Song Select	X	X	
: Tune	X	X	
System : Clock	○	X	
Real Time : Commands	○ (rem. 3)	X	
Aux. Message : Local ON/OFF	X	X	
: All Notes OFF	X	X	
: Active Sense	X	X	
: Reset	X	X	
Notes	rem.1: MMC (Device ID=00~99, 127), MTC, Identity reply rem.2: MMC (Device ID=00~99, 127), MTC, Inquiry rem.3: START, STOP, CONTINUE		

Mode 1: OMNI ON, POLY
Mode 3: OMNI OFF, POLY

Mode 2: OMNI ON, MONO
Mode 4: OMNI OFF, MONO

○ : Yes
X : No

MMC Command List

Command list	Movement (Recorder)
01: STOP	STOP
02: PLAY	PLAY
03: DEFERRED PLAY	DEFERRED PLAY
04: FAST FORWARD	F FWD
05: REWIND	REWIND
06: RECORD STROBE	REC
07: RECORD EXIT	PUNCH OUT
09: PAUSE	STOP
40: WRITE	Refer to MMC Response/Information Field List
41: MASKED WRITE	Refer to MMC Response/Information Field List
42: READ	Refer to MMC Response/Information Field List
44: LOCATE	LOCATE to Setting Data
46: SEARCH	CUE/REVIEW (+/- 1~60 times)
47: SHUTTLE	CUE/REVIEW (+/- 1~60 times)
4C: MOVE	Refer to MMC Response/Information Field List
4D: ADD	Refer to MMC Response/Information Field List
4E: SUBTRACT	Refer to MMC Response/Information Field List

MMC Response/Information Field List	Command
01: SELECTED TIME CODE	READ/WRITE/MOVE/ADD/SUBTRACT
03: REQUESTED OFFSET	READ/WRITE
04: ACTUAL OFFSET	READ
08: GP 0	READ/WRITE/MOVE/ADD/SUBTRACT
09: GP 1	READ/WRITE/MOVE/ADD/SUBTRACT
0A: GP 2	READ/WRITE/MOVE/ADD/SUBTRACT
0B: GP 3	READ/WRITE/MOVE/ADD/SUBTRACT
0C: GP 4	READ/WRITE/MOVE/ADD/SUBTRACT
0D: GP 5	READ/WRITE/MOVE/ADD/SUBTRACT
0E: GP 6	READ/WRITE/MOVE/ADD/SUBTRACT
0F: GP 7	READ/WRITE/MOVE/ADD/SUBTRACT
48: MOTION CONTROL TALLY	READ
4C: RECORD MODE	READ/WRITE
4E: TRACK RECORD STATUS	READ
4F: TRACK RECORD READY	READ/WRITE/MASKED WRITE
51: RECORD MONITOR	READ/WRITE

Inquiry Message List

IDENTITY REQUEST: F0, 7E, <channel>, 06, 01, F7

IDENTITY REPLY: F0, 7E, <channel>, 06, 02, 51, 01, 00, 13, 01, **, **, **, **, F7

51 :Fostex ID
 01, 00 :Device family code
 13, 01 :Device family number VF08
 **, **, **, ** :Software version

Maintenance

Cleaning the exterior

** For normal cleaning, use a soft dry cloth.*

For stubborn dirt, moisten a cloth in diluted detergent, wring it out firmly, and wipe the dirt off. Then polish with a dry cloth. Never use solvents such as alcohol, thinner or benzene, since these will damage the printing and finish of the exterior.

Specifications

Recording/Reproducing

Recording Medium	: 3.5 inch, hard disk (E-IDE type)
Recording Format	: FDMS-3 (*)
Save/Load Format	: FDIO-1 (**)
Sampling Frequency	: 44.1kHz
Quantization	: 16-bit linear (Non expanded)
A/D Converter	: 20-bit 64 times, over sampling, Delta-Sigma
D/A Converter	: 24-bit 128 times, over sampling, Delta-Sigma
No. of Recording Track	: 8 real tracks + 16 additional tracks *2 tracks for simultaneous recording (Maximum)
Vari Pitch Control	: +/- 6%
Crossfade	: 10msec.
Recording/Reproducing Frequency	: 20Hz ~ 20kHz

Input/Output

Input A, B

Connector	: ø6mm Phone jack (Unbalanced) : XLR-3-31 type connector (Balanced)
Input Impedance	: 50kΩ or more (Unbalanced) : 1kΩ or more (Balanced)
Standard Input Level	: -50 ~ +4dBu
Phantom Power (XLR only)	: +48VDC (Setting of ON/OFF with PHANTOM switch)

HEADPHONE

Connector	: ø6mm TRS Phone jack
Load Impedance	: 10Ω ~ 50Ω
Output Level	: 20mW or more (at 32Ω)

STEREO OUT L, R

Connector	: ø6mm Phone jack
Load Impedance	: 10kΩ or more
Output Level	: -10dBV

S/P DIF DIGITAL IN

Connector	: COAXIAL
Format	: IEC 60958 (S/P DIF)

DIGITAL OUT

Connector	: COAXIAL
Format	: IEC 60958 (S/P DIF)

MIDI IN/OUT

Connector	: DIN 5 PIN
-----------	-------------

PUNCH IN/OUT

Connector	: ø6mm Phone jack (An optional FOOT SW Model 8051 can be connected.)
-----------	--

SCSI (Option)

Connector	: D-sub half pitch 50 pin
-----------	---------------------------

Specifications

General

Connector	: 300 (W) x 96 (H) x 217 (D) mm
Weight	: Approx. 2.4kg
Power Supply	: 120VAC 60Hz, 230V~ 50/60Hz (AC inlet type)
Power Consumption	: 18W

Accessories

- : Owner's manual
- : Power Cable

* Fostex Disk Management System-3

** Fostex Data In Out-1

Specifications and appearance are subject to change without notice for product improvement.

Block Diagram

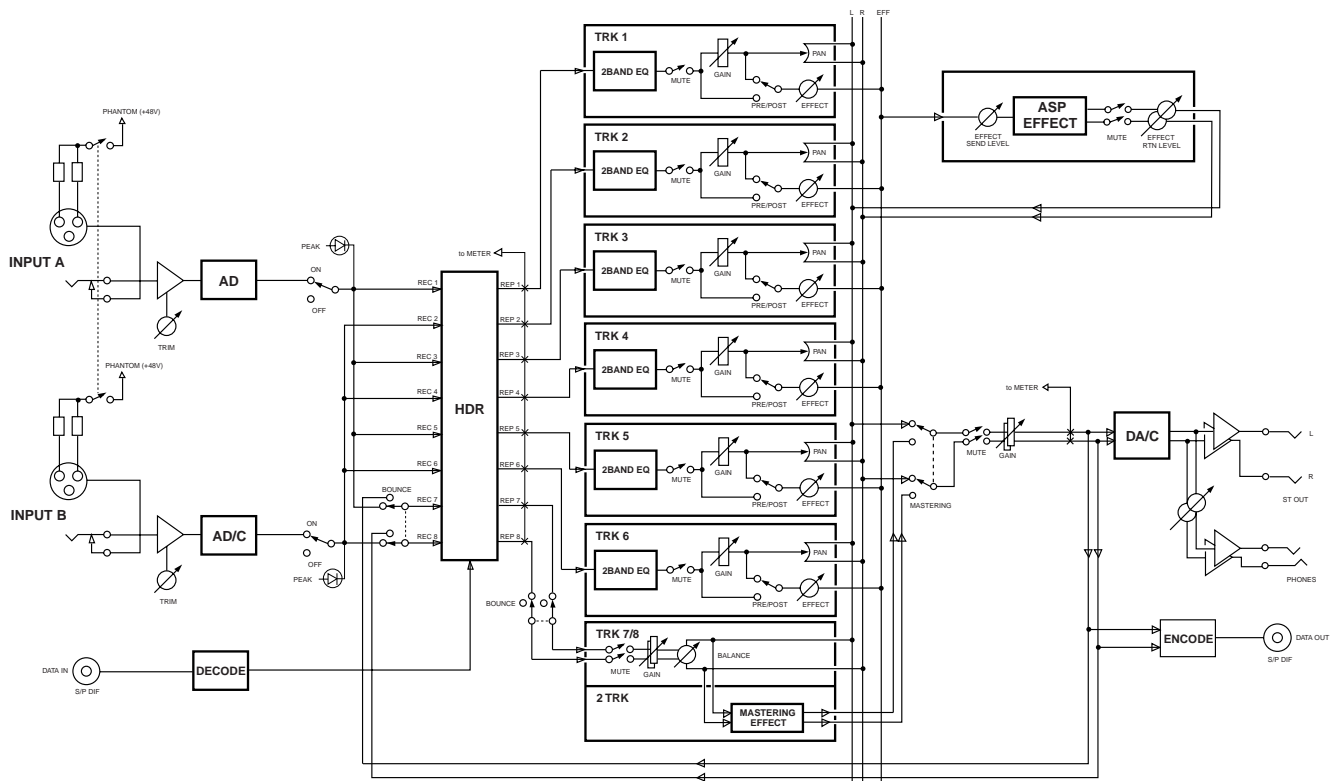

Installing the Model 8340 SCSI card

Follow the procedure below to install the Model 8340 SCSI card in the VF08.

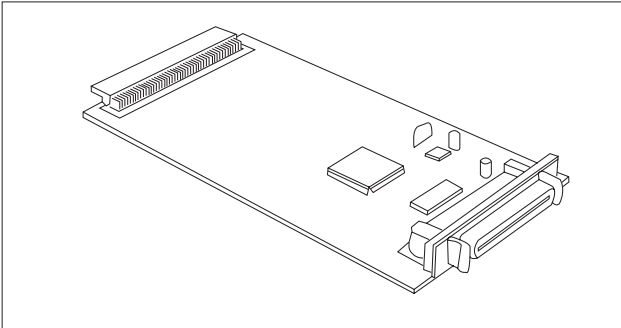

<Notes>

- Before installing the Model 8340 SCSI card in the VF08, turn off the VF08 power and disconnect the power cord.
- The SCSI card is comprised of precision parts. Be careful not to give a strong shock or excess of power when installing the card.
- Follow the procedure below to install the card in the VF08. Note that Fostex is not responsible for any damage of products caused by the incorrect installation.

- 1 Remove the cover panel located on the right side of the VF08. The two retaining screws will be used later for fixing the SCSI card in step 3.

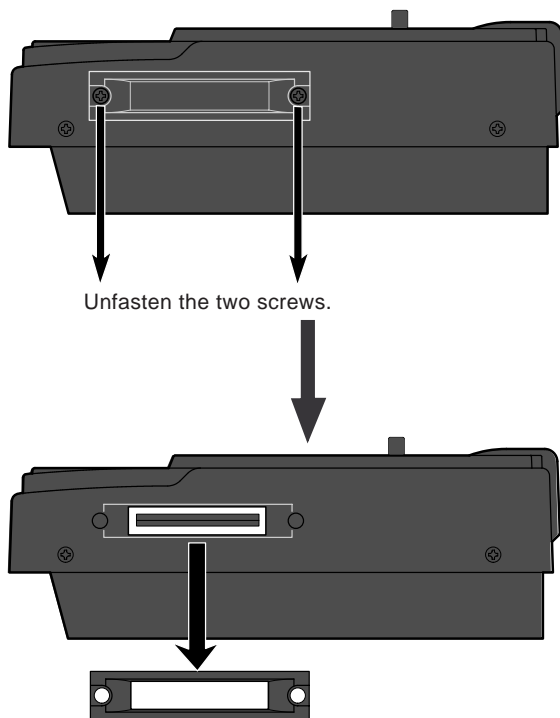

Unfasten the two screws.

Remove the panel.
The blank panel is not used.

- 2 Insert the SCSI card as shown in the figure below until the board meshes with the internal connector. With the component side up, insert the SCSI card gently. Do not push the board with excessive force.

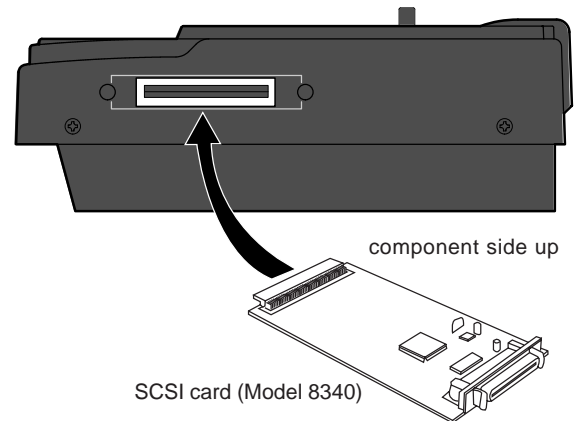

- 3 After inserting the board, fix back the cover panel removed in step 1. Place the panel to the correct position, and fasten it using the screws which are unfastened in step 1.

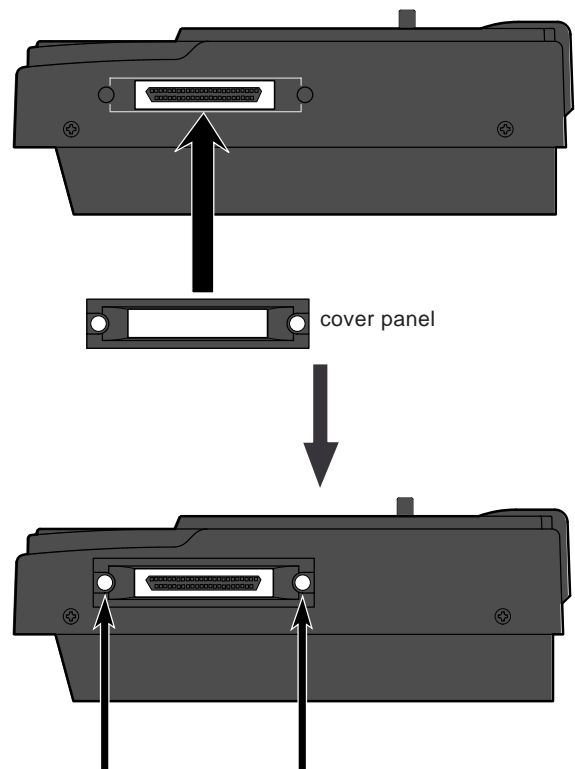

Fasten the screws not to loosen.

Declaration of EC Directive

This equipment is compatible with the EMC Directive (89/336/EEC) - Directive on approximation of member nation's ordinance concerning the electromagnetic compatibility and with the Low Voltage Directive (73/23/EEC) - Directive on approximation of member nation's ordinance concerning electric equipment designed to be used within the specified voltage range.

The Affect of Immunity on This Equipment

The affect of the European Specification EN50082-1 (coexistence of electromagnetic waves - common immunity specification) on this equipment are as shown below.

* In the electrical fast transient/burst requirements, surge, conducted disturbances by radio-frequency fields, power frequency magnetic field, radiate electromagnetic field requirements and static electricity discharging environment, this could be affected by generation of noise in some cases.

FOSTEX DISTRIBUTORS LIST IN EUROPE

* Including non-EU countries.

* underlined: contracted distributors (as of August, 2000)

<AUSTRIA>

NAME: ATEC Audio-u. Videogeraete VertriebsgesmbH.
ADD: Im Winkel 5, A-2325 Velm, Austria
TEL: (+43) 2234-74004, FAX: (+43) 2234-74074

<BELGIUM>

NAME: EML Sound Industries NV
ADD: Bijvennestraat 1A, B3500 Hasselt, Belgium
TEL: (+32) 11-232355, FAX: (+32) 11-232172

<DENMARK>

NAME: SC Sound ApS
ADD: Malervej 2, DK-2630 Taastrup, Denmark
TEL: (+45) 4399-8877, FAX: (+45) 4399-8077

<FINLAND>

NAME: Noretron Oy Audio
ADD: P. O. Box 22, FIN-02631 Espoo, Finland
TEL: (+358) 9-5259330, FAX: (+358) 9-52593352

<FRANCE>

NAME: Musikengro
ADD: ZAC de Follieuses, B. P. 609, 01706 Les Echets, France
TEL: (+33) 472 26 27 00, FAX: (+33) 472 26 27 01

<GERMANY>

NAME: Studio sound & Music GmbH
ADD: Industriestrasse 20, D-35041 Marburg, F. R. Germany
TEL: (+49) 6421-92510, FAX: (+49) 6421-925119

<GREECE>

NAME: Bon Studio S. A.
ADD: 6 Zaimi Street, Exarchia, 106.83 Athens, Greece
TEL: (+30) 1-3809605-8, 3302059, FAX: (+30) 1-3845755

<ICELAND>

NAME: I. D. elrf. electronic Ltd.
ADD: ARMULA 38 108 REYKJAVIK, ICELAND
TEL: (+354) 588 5010, FAX: (+354) 588 5011

<ITALY>

NAME: General Music S.p.A.
ADD: Via delle Rose, 12 S. Giovanni M. (RN), Italy
TEL: (+39) 0541-959511, FAX: (+39) 0541-957404

<THE NETHERLANDS>

NAME: IEMKE ROOS AUDIO B. V.
ADD: Kuiperbergweg 20, 1101 AG Amsterdam, The Netherlands
TEL: (+31) 20-697-2121, FAX: (+31) 20-697-4201

<NORWAY>

NAME: Siv. Ing. Benum A/S
ADD: P. O. Box 145 Vinderen, 0319 Oslo 3, Norway
TEL: (+47) 22-139900, FAX: (+47) 22-148259

<PORTUGAL>

NAME: Caius - Tecnologias Audio e Musica, Lda.
ADD: Rua de Santa Catarina, 131 4000 Porto, Portugal
TEL: (+351) 2-2086009/2001394,
FAX: (+351) 2-2054760/2087488

<SPAIN>

NAME: Multitracker, S. A.
ADD: C/Garcilaso No.9, Madrid 28010, Spain
TEL: (+34) 91-4470700, 91-4470898, FAX: (+34) 91-5930716

<SWEDEN>

NAME: Professional Television AB
ADD: Kavallerivagen 24, 172 48 Sundbyberg, Sweden
TEL: (+46) 8-59798000, FAX: (+46) 8-59798001

<SWITZERLAND>

NAME: Audio Bauer Pro AG
ADD: Bernerstrasse-Nord 182, CH-8064 Zurich, Switzerland
TEL: (+41) 1-4323230, FAX: (+41) 1-4326558

<UK>

NAME: SCV London
ADD: 3A 6-24 Southgate Road, London N1 3JJ, England, UK
TEL: (+44) 171-923-1892, FAX: (+44) 171-241-3644

Memo

Fostex[®]

FOSTEX CORPORATION

3-2-35, Musashino, Akishima-shi, Tokyo, Japan 196-0021

FOSTEX CORPORATION OF AMERICA

15431, Blackburn Ave., Norwalk, CA 90650, U. S. A.