

# Technical White Paper



*NF-1*

NEAR FIELD STUDIO MONITOR



**FEATURES**

- ◆ Employment of a 16 cm woofer featuring a newly developed HP diaphragm has made it a reality to reproduce low distortion and highly transient sound which used to be only a dream with conventional diaphragms.
- ◆ Anti-resonance of diaphragm edges has been successfully eliminated. The newly developed UDR tangential diaphragm edge and push-pull damper used in the woofer provide a breakthrough in linearity and responsiveness to subtle signals.
- ◆ Highly rigid die-cast aluminum frames engineered to eliminate sound colorization often occurring due to undesirable natural resonances are used on the woofer and tweeter.
- ◆ Tweeters, comprising a newly developed UFLC diaphragm (soft dome) offering excellent response and reproduction performance, are capable of handling a wide frequency coverage of up to 40 kHz.
- ◆ The network used is of an exceptionally low loss 6 dB crossover design which ensures extremely natural transition between the woofer and tweeter.
- ◆ The time-aligned enclosure has a baffle shaped to keep it free of natural resonances caused by diffracted reflection sounds.
- ◆ The use of an HP diaphragm and dome tweeter has widened the listening area, which was not possible with previous technology.
- ◆ An ideal internal processing method of natural resonances developed by reflected sounds within enclosures is now an actuality by removing such natural resonances by an HP sound reflector.
- ◆ Terminals for bi-amplification systems are provided for convenience in meeting studio-specific environmental requirements.
- ◆ Employment of minimal magnetic leakage design on both woofers and tweeters makes placement of the system in close proximity to monitors viable.

**THE "SHOULD BE" OF MONITOR**

Before undertaking development of NF-1, we recognized anew the following 5 points as mandatory requirements near-field monitors should satisfy.

*1)To elevate the ability to analyze and check original sounds and to reproduce said original sounds to an absolutely optimal level.*

- 2)To express to the fullest extent all the musical nuances intended by the musicians and engineers.*
- 3)To provide engineers with a highly efficient work environment where they can work, unconscious of the existence and intervention of sound reproduction speakers, free of stress and fatigue caused by the necessity of corrections of properties inherent to conventional speakers.*
- 4)To be with horizontal directivity wide enough to ensure minimal changes in timbre and sound field regardless of engineers' horizontal position. Vertical directivity, on the other hand, is better to be narrow to enable circumvention of reflection from mixing consoles.*
- 5)To meet trends in recording studios of using small yet high performance speakers. In recent years, cases abound where small speakers are used in the near field.*

NF-1 has been developed to incorporate the following elements as the engineering development themes necessary not to miss any of these 5 points.

**REQUIREMENTS OF SPEAKER DRIVERS**

- a. Reproduction frequency range to be the widest possible (60Hz to 40kHz)
- b. Fast response perceptible in the original sound to be retained
- c. Sufficient resolution to allow for desired signals and noise present in floods of information to be discernible
- d. Localization of individual sound images to be excellent
- e. High input and output capability without altering sound quality
- f. Driver diameters to be as small as feasible, as dictated by the idea that a point sound source is an ideal sound source, and systems to be no more than 2-way
- g. No specific sound to develop from any of diaphragm materials, shape or structure
- h. Good directivity

**REQUIREMENTS OF SPEAKER ENCLOSURES**

- a. Size to be small enough to provide convenience in securely locating systems on mixing consoles to ensure optimal proximity to the listening point
- b. Time alignment to be impeccable within the listening area
- c. Natural resonance sounds not to be generated from enclosures
- d. To provide rich and deep sound to give listeners the sensation of presence of a natural sound field (Listeners are not to perceive that the sound source is speakers in an enclosure.)

## BASICS OF THE HP SYSTEM

In addition, upon development of a near-field monitor, we decided to expose our speakers to users' evaluation as to its true value, by placing the focus on a passive type, or non-amplified type, which will provide users with an opportunity for optimum speaker driving in a manner meeting studio-specific requirements.

### BASICS OF THE HP SYSTEM

'HP' is an abbreviation of hyperbolic paraboloid which is normally called an 'HP shell' or hyper shell, and is a 3rd-order curved surface structure. This structural theory has long been well known in the field of the structural mechanics.

The Orchestra House in Sydney, Australia, a good example to which the HP structure is applied, is famed world-wide for its beautiful form.

The HP structure is characterized primarily by the fact that movement of a line connecting 2 line segments which exist on different surfaces results in composition of a hyperboloid and paraboloid.

Our purpose and reason for the world's first application of this HP structure to the NF-1 near-field monitor as an ideal diaphragm configuration can be explained by 3 acoustic advantages which were not available from conventional diaphragms. Without solution to these 3 items, it would be impossible to predict what the next generation near-field monitors should be.

### APPLICATION TO DIAPHRAGMS OF THE HP SYSTEM

#### 1) HP diaphragms composed of lines

Being a curved surface, and unlike conventional diaphragms structured with curved lines, the HP structure basically consists of straight line structures.

As a result, involved in-plane stress is only a shearing force without the presence of bending stress, culminating in strength at high level. Strength of such level can raise the resonance frequency of diaphragms to reproduce fast-rising sounds that make listeners perceive faster responsiveness over conventional diaphragms. Besides, the straight lines, being of varied lengths, prevent any specific standing waves from being created on diaphragms, with subsequent freedom from peaks, and thus, resulting in smooth response.

#### 2) HP Diaphragms having torsional curved surface

Nothing is free of natural self-resonance frequency. It has been known that self-resonance frequency creates sound inherent to the material, perceptible as sound unique to it. Speaker diaphragms are no exception and have material-specific sound which characterizes the speaker. In the case of home use speakers, such timbre may appeal to listeners as being comfortable and pleasant. However, when using speakers A and B for the purposes of monitoring the same program source in different timbre will mean that some particular frequencies are restricted by speakers with their natural resonance frequency. It can be, therefore, reasonably assumed that ideal diaphragms for monitor speakers should have natural resonance suppressed to the fullest possible extent.

The HP structure is characterized by its torsionally curved surface structure. Figures 2 and 3 show FEM modal analysis results of the 1st to 4th free resonances observed on a 15<sup>0</sup> torsional HP structure and on plane structure, where no evidence of major resonance is apparent on the HP structure.

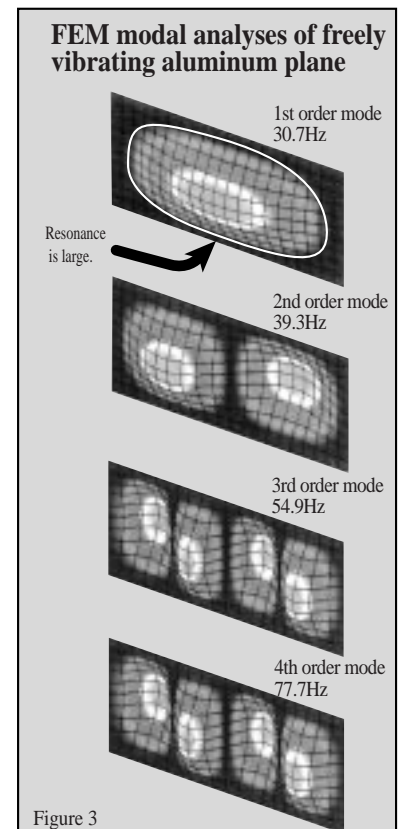
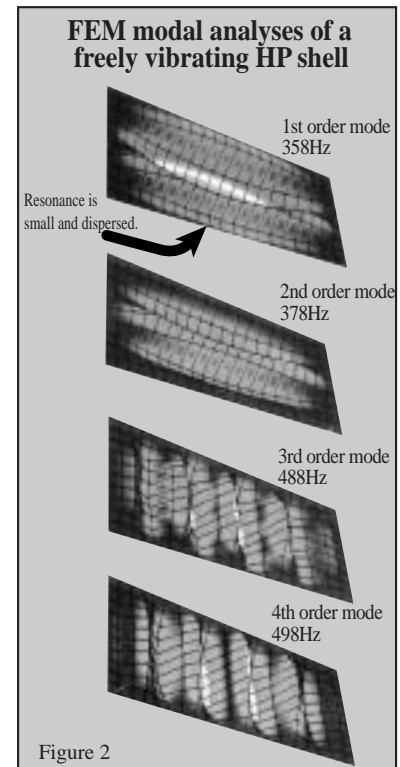

One of the properties of the HP structure is the unlikelihood of development of inherent timbre because of widely dispersed resonance. This finding has made it possible to use, without encountering any particular major resonance, materials such as metal and carbon fibers having high propagation velocity and low  $\tan \delta$  (internal loss) which used to be regarded as properties to be overcome. The Figures 2 and 3 indicate that resonance is shifted up on HP diaphragms by one decimal point and is narrower, when compared to a plane surface. This represents that HP diaphragms provide higher strength and finely dispersed resonance. This property of dispersed resonance can be used as a good proof that HP diaphragms are ideal where no particular resonance disturbs reproduced sound.

### 3) HP diaphragms, easy to analyze and excellent in reproducibility of simulation

HP diaphragms' complexity in configuration can be overcome by development of a design method which involves CAD/CAM techniques, whereby optimal configuration design of curved surfaces and mold machining will become possible. Configuration of HP shells is optional, i.e., the number of divisions and degree of torsion of curved surfaces (height of ridges and depth of troughs) can be determined by the aimed response characteristics/sound quality. In addition, articulate configuration, though the curved surfaces are complex, provides ease in analysis and reproducibility of simulation.

Figure 4 presents comparison data of frequency responses taken from 16 cm woofers with an HP or conventional straight diaphragms. The HP diaphragm speaker is free of evidence of either dips

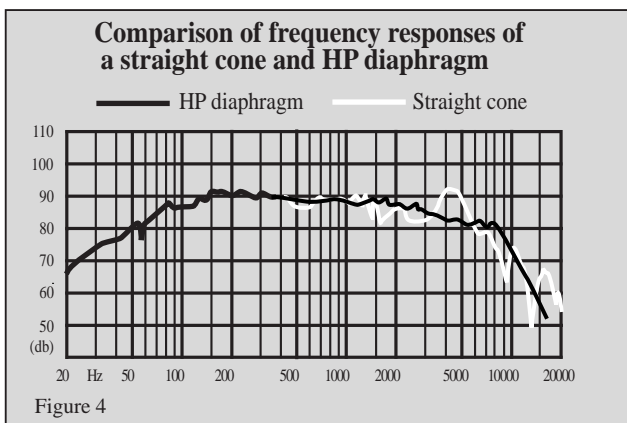

at around 600 Hz or peaks at the high end of around 4500 Hz due to anti-resonance of the edge. Figures 5 and 6 compare the FEM modal analysis results.

Figure 5 represents a conventional straight cone. Cone break-up is present at 596 Hz in the axis-symmetry mode (in the direction of circumference), causing the 3rd harmonic distortion which is said to be detrimental to sound quality, to develop.

Figure 6 shows an HP diaphragm. Axis-symmetry mode resonances can be seen at neither of the vicinity of 596 Hz nor at any other frequencies.

At this stage, we can say that it has been successfully verified that the use of HP diaphragms can surmount the shortcomings of conventional cones, eliminate speaker-specific sound colorization, and finally, attain ideal speakers capable of offering precise sound reproduction.

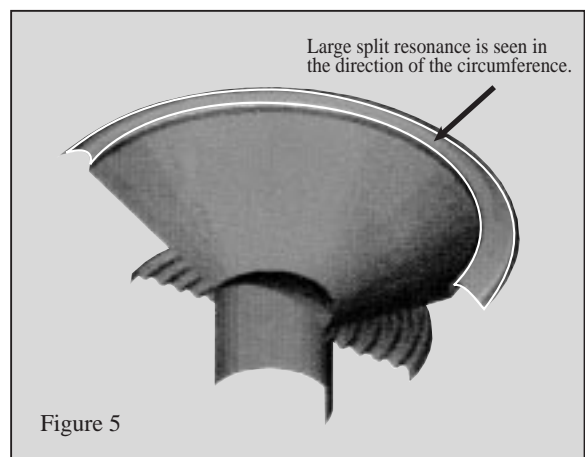

**FEM modal analysis of a straight cone**

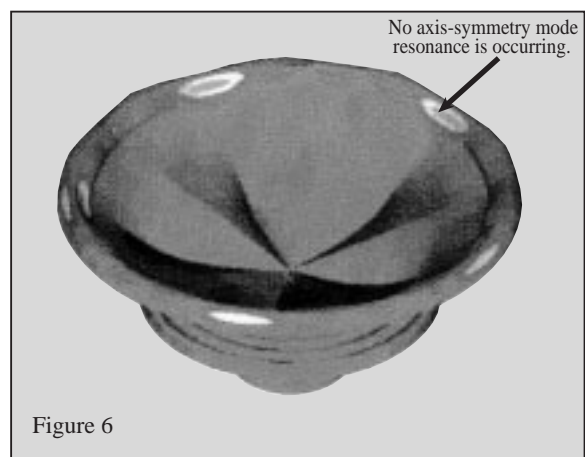

**FEM modal analysis of an HP diaphragm**

**FEATURES OF THE WOOFER UNIT**

Development of speaker systems vitally involves the 3 elements of driver units, networks and enclosures.

On development of NF-1, thorough investigation of these 3 elements was made to have them well balanced, so as to achieve total quality by attaining incomparable performance from the same size drivers.

Woofers which are responsible for reproduction of base sound must meet the following 3 points which are major sound quality-determining factors:

- a. To be light in weight and high in rigidity, with smoother response*
- b. To have a reasonably extended high end and wider directivity*
- c. To achieve ideal performance without need of any cross-over provision*

The introduction of HP diaphragms and newly developed Biodyna composite material in the vibratory system, being the key portion for successful achievement of the above 3 factors, has made the NF-1 woofer an ideal bass unit.

**1) Configuration of HP diaphragms**

In order to disperse stress, inflection points are located at the top and bottom to form vertical symmetry, and the height of curved surfaces is set for optimal frequency dispersion as dictated by FEM modal analysis results, with pentagonal divisions which create asymmetry to the center as the basic option.

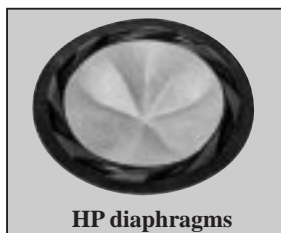

**2) Properties required of diaphragm materials**

Factors of importance with diaphragm materials are:

- 1) Propagation speed
- 2) Modulus of flexural rigidity
- 3) Internal loss ( $\tan\delta$ )

For NF-1 diaphragms, we have set the following target values, which we think the next generation near-field monitors cannot be without.

- 1) **Propagation speed: 3000 m/sec., minimum.**  
Conventional pulp materials: 2600 m  
PP (polypropylene): 1290 m
- 2) **Modulus of flexural rigidity: 6.0 (2 times that of conventional materials, or greater)**  
Conventional pulp materials: 2.81
- 3) **PP (polypropylene): 1.43 m**  
**Internal loss ( $\tan\delta$ ): 0.06, minimum.**  
Conventional pulp materials: 0.033  
PP (polypropylene): 0.08

To achieve these values, the materials described below are introduced:

**A) Base pulp: a mix of NBKP and banana fibers**

Conventionally used NBKP wood pulp alone is accompanied by sound distortion due to lack of bonding strength at the pulp fiber level. This distortion component present in reproduced sound has been considered to be an integral element with wood pulp, as seen in comments such as 'reminds listeners of paper'. Continual study for usability of various types of materials such as carbon fibers, PP, nylon, polystyrene, metal, etc. for vibratory systems, made ever since development of wood pulp cones, has failed to find any material compatible with wood pulp which has well balanced  $\tan\delta$  and



propagation velocity. Meanwhile, Fostex has succeeded in development of banana pulp materials comprising long fine fibers with a high level of bonding strength provided by the intrinsic starchy component. This banana pulp provided an opportunity for exploration into new dimensions where distortion-free pulp cones can be embodied without sacrificing the intrinsic properties of pulp. Adoption of banana pulp and NKP as the base pulp has made an excellent well-balanced cone available for NF-1.

**B) Enforcement material A: Carbon fiber of a super high elasticity modulus**

Cases abound where carbon fibers are used for cones. The carbon fibers contained in NF-1 cones combine the property of super high elasticity modulus working as an enforcement material. With propagation speed of 16,000 m/s, equal to that of diamond, they allow for higher sound velocity and more preferable modulus of flexural rigidity.

**C) Enforcement material B: Super-fiber, PBO (poly-ρ-phenylene benzooxazole)**

a family of aramid fibers. This fiber, used in combination with the enforcement material A, with a strength 2 times that of previous aramid fibers, adds flexural rigidity and permits substantial improvement in rupture resistance.

**D) Enforcement material C: Pearl mica**

Attainment of ideal diaphragms is impossible without success in getting elements which raise propagation velocity well balanced, with high internal loss maintained. Pearl mica allows for

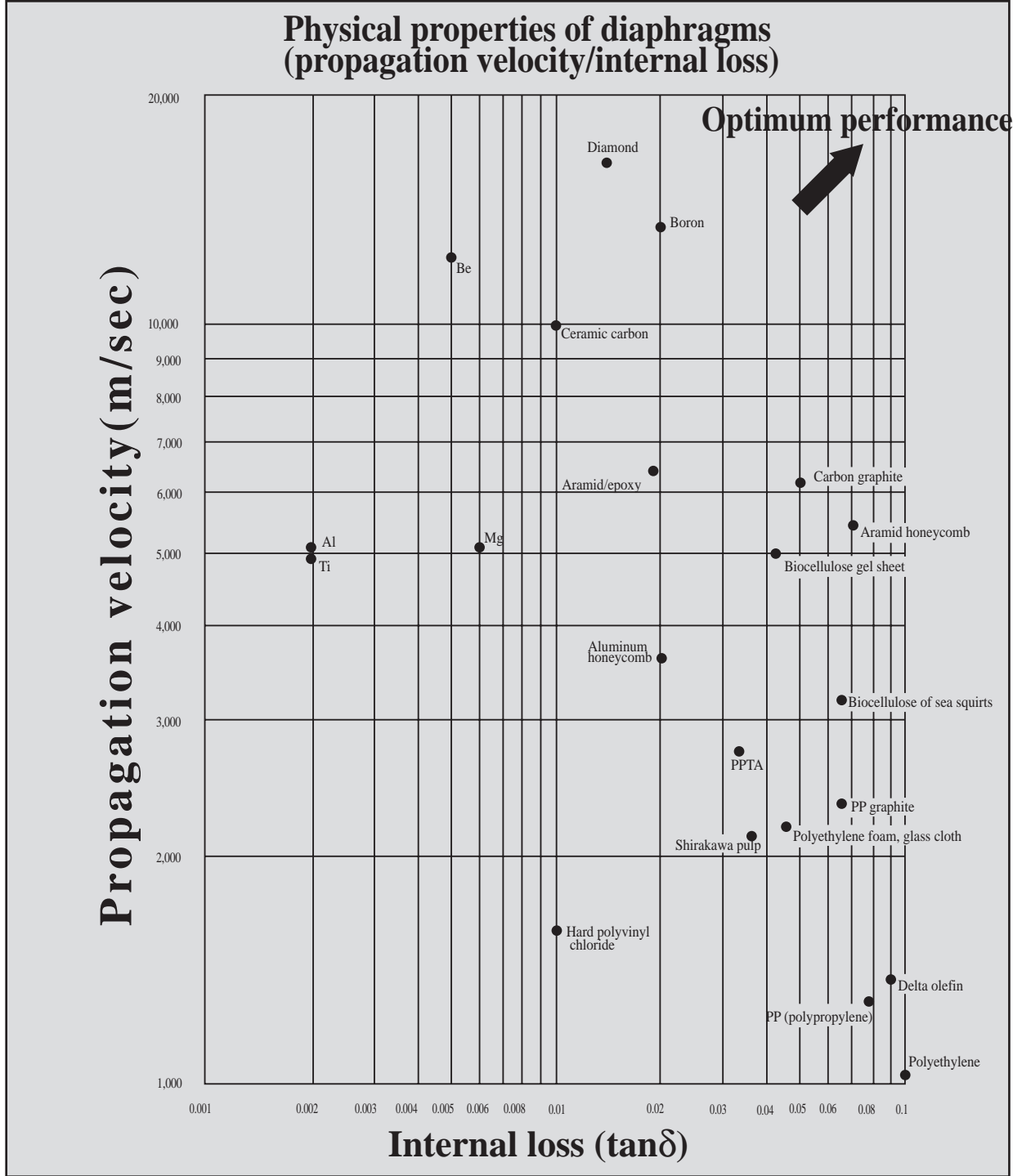

faster surface propagation velocity of HP diaphragms. Combining properties of enforcement material A, B and C, sound quality giving the sensation of the fastest response, which has not been available, is now an actuality.

**E) Super damping fiber: Cellgaia pulp**

Smooth roll-off response can only be achieved with an appropriate thickness-stiffness parameter. Previous techniques do not allow for compatibility of thickness-stiffness parameter and propagation velocity, requiring that propagation velocity be sacrificed to a certain extent to attain the desired thickness-stiffness parameter. Fostex has succeeded in development of new materials which will allow us to achieve ideal internal loss without impairing propagation velocity. The fruit of our labor is the use of Cellgaia pulp resulting in an increase in

internal loss without resorting to reduction in propagation velocity of materials.

**F) Matrix material:bio-cellulose**

This material elevates bonding strength of each pulp and enforcement materials, and permits diaphragms of high airtightness to be formed due to the fiber filament diameter being as fine as only 30nm, which no other pulp cones have ever materialized.

**G) Secondary impregnant**

Sound quality of wood pulp cones is said to fluctuate depending on ambient humidity. The woofer for NF-1 is engineered to be humidity-resistant to an extent incomparable to previous wood pulp-based vibratory systems, by using special nitrocellulose materials capable of

**Physical properties of diaphragms (internal loss/propagation velocity/modulus of flexural rigidity)**

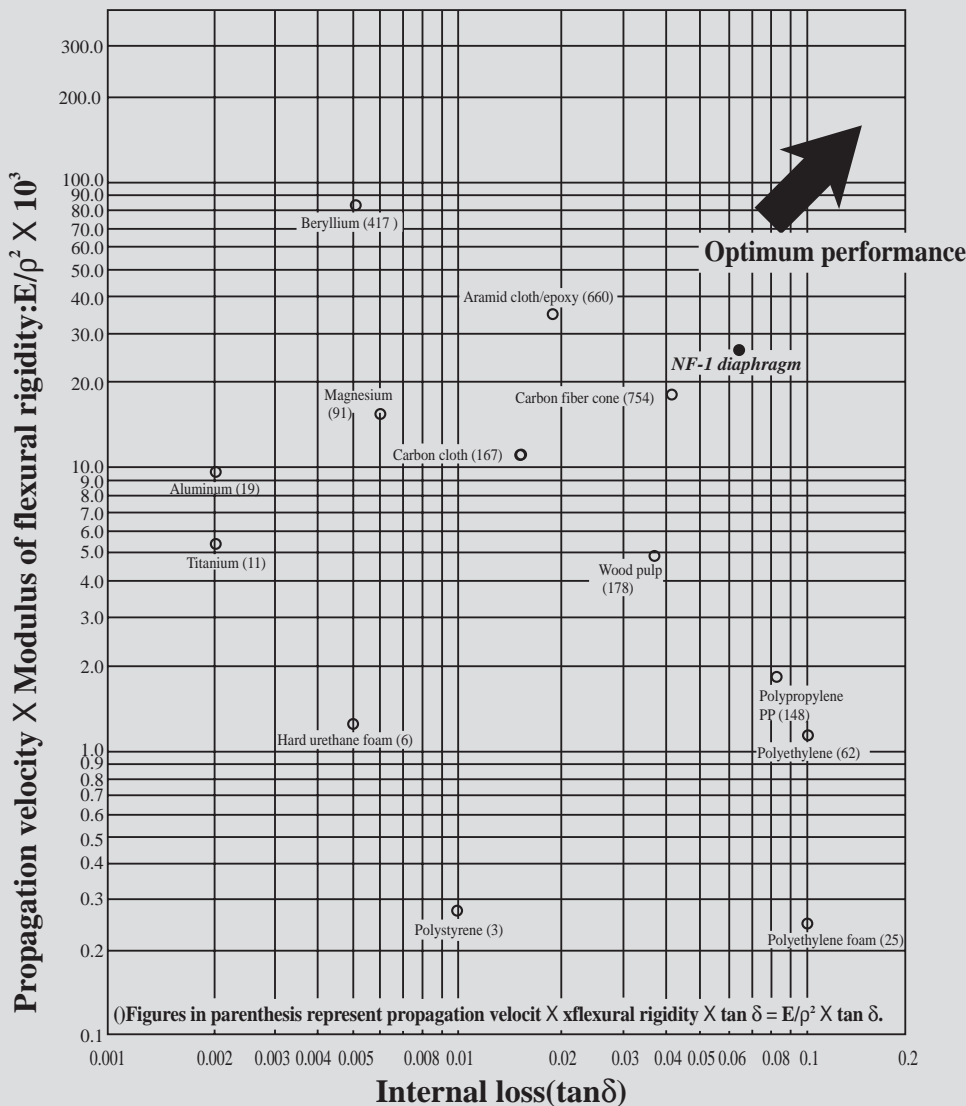



---

enhancing the bonding strength of all materials, and subsequently, substantially improving resistance to humidity. These materials, being equivalent to the coating applied on the famed Stradivarius violins, help give the feeling of being present in a natural sound field and reproduce the true sound of musical instruments in higher fidelity.

Previously used olefin-based PP materials caused strength to fluctuate greatly depending on the temperature. This means that changes in room temperature and rise in the voice coil temperature, when driven, will result in considerable changes in sound quality. They are fated to be a source of changes in sound quality due to seasonal temperature changes.

The woofer found in NF-1 is the incomparably successful compilation of our 50-year long research and development efforts for elementary technologies in wood pulp-based diaphragms.

Physical properties of this new Biodyna are given below:

<b>Density:</b>	<b>0.64 (g/cm<sup>3</sup>)</b>
<b>Young's modulus:</b>	<b>11.02 (GPa)</b>
<b>Propagation velocity:</b>	<b>4380 m/sec.</b>
<b>Internal loss:</b>	<b>0.068</b>
<b>Modulus of flexural rigidity (<math>\sqrt{E/\rho^3}</math>):</b>	<b>6.5</b>
<b>Propagation velocity X Modulus of flexural rigidity:</b>	<b>26.98 X 10<sup>3</sup></b>

Supported by high level strength and large internal loss, which were attained for the first time, and by the use of a strong magnetic circuit and rigid die-cast aluminum frame, superior sound quality with high transiency and linearity, which had not been available from any speakers, became a reality.

### 3) HP diaphragm adapter

Drive points of HP diaphragms can seriously impact characteristics. However, analyses using computers and subsequent technical experiments have discovered that the high end will be extended and directivity improved if driven near the center. For the woofer being discussed now, we chose a point at about 25 mm as the optimum performance point.

As a consequence, the network coil for the woofer became superfluous without loss of smooth transition to the tweeter.

---

When determining the blending detail not to miss a single piece of the subtlest signal components in reproduced sound, a greater amount of attention to propagation velocity than to that of diaphragms was paid.

### 4) UDR tangential edge

When speakers are driven, the roll of edges (surrounds) plays a major part as the suspending member. They, as part of diaphragm systems, are also greatly responsible for the reproduced sound quality.

This fact makes it essential to be most careful when designing edges, where more points of difficulty than in diaphragms are involved, when deciding on configuration and materials.

What we chose for this project are special urethane foam materials having greater internal loss and elongation performance, as well as excellent durability. They are a breakthrough of a newly developed structure called a UDR tangential edge, on which up-roll and down-roll are bonded at their tangential surfaces. They are configured, through FEM modal analyses, to function optimally as edges. Targets set at that time include:

#### Reduction in anti-resonance at mid-frequencies:

No previous rolled edges were without anti-resonance. The voice coils we adopted are structured tangentially to voice coil movement.

Freedom from axis-symmetry anti-resonance caused by movement of the outer periphery of cones and inner periphery of rolls in the mutually reversed direction produces flat response and reduces harmonic distortions to an absolutely minimal level.

**Reduction in anti-resonance at high frequencies:**

Added strength and a shift to disperse at high frequencies prevent any natural high peaks from being generated, in

contrast to rolled edges. Chances will be remote that peaks and dips will take place in the frequency response, and smooth characteristics will be achieved as with HP system diaphragms. In this way, our philosophy of elimination of physical distortion due to components ranging from diaphragms to edges has been brought into existence, allowing for natural and higher fidelity reproduction.

Figures 10 and 11 show FEM analysis results of the acceleration response, evidencing a high level of responsiveness which used to be a mere gleam in the sound engineers' eyes.

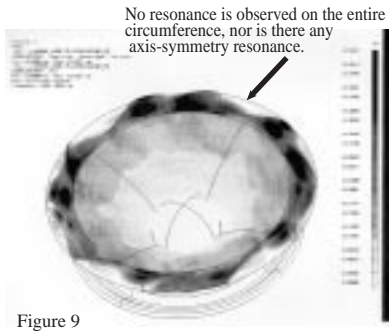

Figure 9

**Improvement of amplitude response:**

It is seen that suspension characteristics, being a soft clipping type which works to gradually restrict movement when the magnitude is symmetrical and large, are ideal.

These characteristics are of particular importance to monitor speakers, in the sense that they do not permit listeners to perceive distortion if subjected to excessive input power.

Presence of an inflection point is apparent. Rapid change starting at this inflection point develops harmonic distortion.

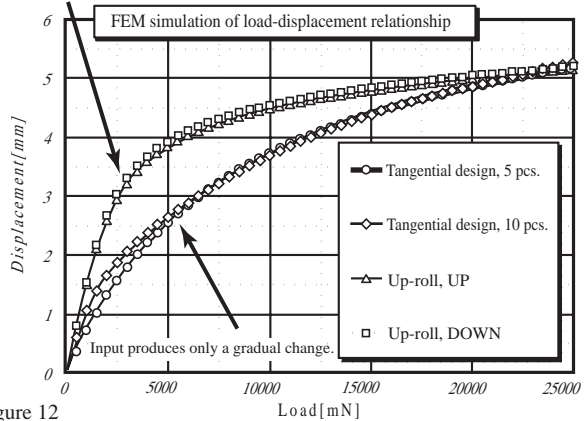

Figure 12

**FEM analysis of edge-displacement relationship**

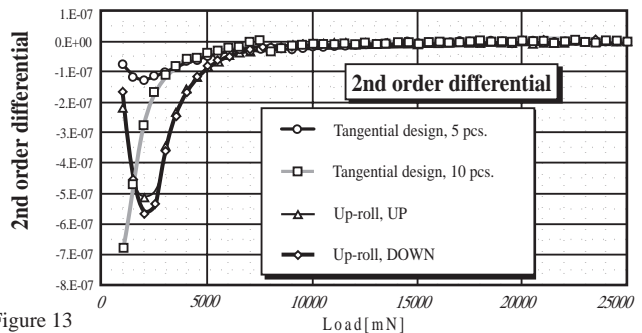

Figure 13

**Evaluation result of 2nd-differential of bi-linearity of an edge**

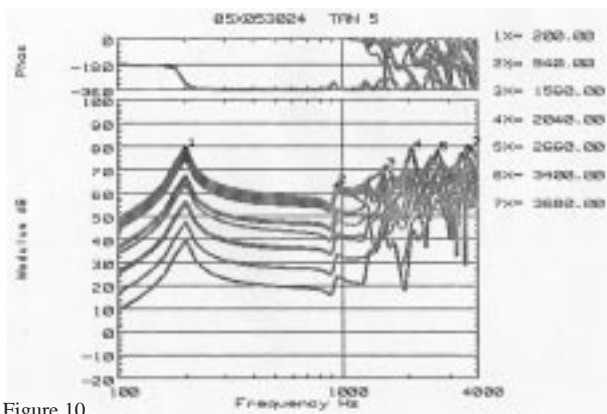

Figure 10

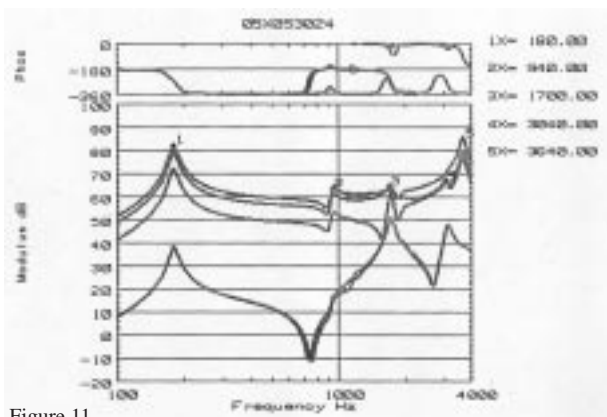

Figure 11

**Improvement in rolling:**

This tangential design is strong enough for the plane dividing the rolled edges in a tangential manner not to yield to horizontally applied stress. Rolling is unlikely to occur to this UDR tangential edge even when a high input power is applied, while a contact by the voice coil with stationary structure of a speaker is commonplace with conventional rolled edges.

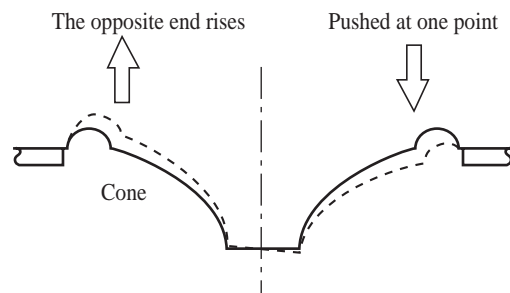

Figure 14

**Simulation of a rolling edge**

**4) Double-damper of a push-pull structure**

The suspension function of dampers is to always keep a voice coil centered. NF-1, the target for which is perfection of every function of it, employs a double-damper which is advantageous in view of structure but very time consuming to produce, and is seen mostly in expensive speaker systems. For this particular application, considering the fact that amplitude characteristic greatly impacts sound quality, we developed an advanced form which can provide longer strokes than usual, so that a vertically symmetrical push-pull structure can be constituted for assurance of superior hysteresis characteristic, in order not to adversely affect amplitude response characteristic which greatly influences sound quality. (Reference the assembly drawing)

A high degree of resistance to heat, as well as durability to vibration, is attained by the use of a meta-based aramid fiber cloth.

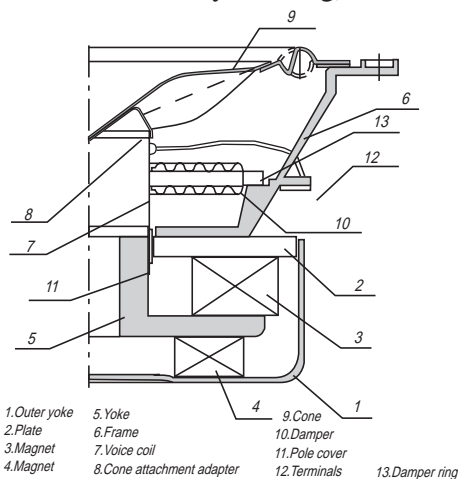

**5) Magnetic circuit**

The magnetic circuit is designed to be sufficiently powerful to be able to reproduce the deepest bass sound for such rather small diameter speakers. Magnets used are a large 110 mm outside diameter strontium ferrite magnet and a 90 mm outside diameter repulsion magnet, which form a repulsing magnetic circuit.

The magnetic circuit created by an 8 mm thick top plate, or 2 times that of previous equivalents, and a long voice coil of a winding length extending to 11 mm and of a 35 mm diameter, can produce a powerful 10.5 force factor with a 1.1T flux density. As a result, successful reproduction of fullest bass sound has been realized from a small speaker system of only an 11 liter volume.

An 18 mm diameter ventilation hole is provided on the center pole for improvement to bass sound and heat dissipation performance.

The use of an outer yoke can keep display CRTs completely free from an influence of magnetic leakage.

**6) Voice coil**

A coil measuring 35 mm in diameter and wound of a 0.19 diameter wire is very large for 16 cm speakers. We believe that the use of hard duralumin for coil bobbin material must not allow to deteriorate the sense of fast reaction in the reproduced sound. Better heat-resistance characteristic and superb sound transiency are also attained by the use of such material.

**7) Die-cast aluminum frame**

For speakers made of a large magnetic circuit that can create very powerful driving force to be firmly secured to the front baffle, conventionally used metal or plastic frames are far from the optional. To deal with this problem, we decided to use die-cast aluminum frames.

Additionally, die-cast aluminum frames provide some other key advantages such as smaller magnetic leakage and better heat dissipation characteristics.

**FEATURES OF THE TWEETER UNIT**

The following 3 points are considered to be most important to the high frequencies reproduction of the next generation of monitor speakers:

- a. *High end to extend beyond 30kHz*
- b. *Deterioration of directivity to be no greater than 6 dB at 20 kHz and 30° off axis*
- c. *Frequency response to be free of peaks and dips, sound quality not to be characterized by inherent factors and distortion to be at the lowest possible level*

Moreover, the most acceptable tweeters are those in which input power-dependent changes in tone quality occur to only a minimal extent. To embody this requirement, NF-1 comprises a tweeter employing a 20 mm diameter soft dome made of newly developed UFLC materials and a die-cast aluminum frame.

The feature of soft dome diaphragms is that it is possible to use materials, the Young's modulus of which is not excessively high while the internal loss of which is large. This enables a good balance in dispersed resonances occurring in the vibration mode. Materials having a high Young's modulus, such as aluminum and titanium, allows sound to follow input signals very fast. However, even small internal losses cause high peaks to develop at high end frequencies, resulting in deterioration of

transiency and thus in metal-specific sound. Hard dome tweeters, therefore, are suitable for speaker systems where the aim is for creation of sound characterized by such materials (metal-specific sound).

### **1) UFLC material**

A common previous practice when producing soft domes is direct application or coating of damping materials on polyester cloth to avoid adverse effects of such materials caused by porosity or specific inherent sound on the reproduced sound. This way of production of soft domes, however, is subject to variations in the amount of applied damping materials, resulting in generation of dips in the response due to pinholes, low output level due to excessive application of damping materials, or deteriorated high end reproduction due to loss of material strength. Our new development, being the UFLC materials, is our solution to these problems. With it, light and highly stable diaphragms have become available.

The UFLC materials consist of the following component materials:

#### **U: Polyurethane**

This plastic features large internal loss, light weight and good bonding performance.

#### **F: Film**

Prior processing is given to polyurethane resin to roll it to an extremely thin film of a consistent 25  $\mu\text{m}$  thickness.

#### **L: Laminated**

The base material and polyurethane film are pressed while heated to bond them tightly together.

#### **C: Cloth**

The base material is large-meshed porous polyester cloth, chosen for its lightness and strength.

The use of this UFLC material provides a 30% weight reduction and consistent quality. The dome shape of a newly developed special configuration brings about ideal performance characteristics for soft domes.

The frequency response range widely and naturally extends to the extreme high end of frequencies, which had not been possible before development of this dome design, reproducing each segment of delivered sound signals to its highest fidelity.

### **2) Die-cast aluminum frame**

Conventionally, tweeter frame materials for speaker systems of this class have been plastics such as

ABS. Incapable of suppressing high frequency vibration energy, plastic frames are usually accompanied by undesired noise caused by resonance, and thus poor transiency.

With the use of a 6.5 mm thick die-cast frame on the NF-1 tweeters to assure the necessary and sufficient strength, this problem has been solved, and conditions become possible for utilization of the merits and advantages of the high grade UFLC diaphragms to the fullest extent. Consequently, highly transient sound quality has resulted. The athletic track-shaped and tapered frames successfully reduce magnitudes of natural resonance and make it possible to place the tweeter closest to the woofer to allow for the narrowest phase shift range.

### **3) Low-leakage magnetic circuit**

To avoid interference with nearby magnetic devices and displays, a canceling magnet is used in the magnetic circuit. The canceling magnet functions to lead outflow of the lines of magnetic force to the gap, elevating flux density in the gap to as high as 1.2T.

---

**FEATURES OF THE ENCLOSURE**

---

### **1) Driver arrangement oriented for time alignment**

The most important characteristics of speaker systems include a phase characteristic. This characteristic is of particular importance to monitor speakers at the places where they are used for monitoring. The prime measure taken to address this issue was execution of positional alignment of the woofer and tweeter to locate them as close to each other as possible for the maximum available monitor area.

NF-1 is designed for optimal sound when listened to at positions between the axes of the woofer and the tweeter, if connected in phase. In the case of opposite phase connection, the optimal listening positions shift beyond the tweeter position, with the optimal listening range being narrowed.

Application conditions of NF-1 in studios are the determining factor for connections to ensure perfect phase characteristics. In-phase connection should be the primary option, unless otherwise dictated by the application environment.

Due to the fact that human ears are very sensitive to the horizontal direction, arrangement of drivers in that direction is undesirable in terms of phase. It should be kept in mind that perfectly time-aligned NF-1 is designed for use in an upright position.

## 2) Board thickness

Strength and weight are key factors for enclosures to assure optimal sound quality. Low cost enclosures allow for undesirable resonances to be generated, and, as a consequence, listeners end up with monitoring sounds that contain signals not present in the fed signals. NF-1, very unlike other 11 liter volume enclosures, uses a 21 mm thick MDF material to add extraordinary rigidity to it. Our concern for rigidity is especially apparent in the front baffle to which the woofer is mounted. It measures 33 mm thick to ensure sufficient strength for positive fastening of drivers within the enclosure, as well as consideration to time alignment. Rounded edges of the front baffle reduces reflection of mid-frequency sounds from the edges.

## 3) Sound absorbent materials

Inclusion of sound absorbent wool in enclosures is commonplace. This practice, however, exhibits the following problems:

- a. Loss of dynamism and reduced massiveness in bass sound occur due to impediment to movement of air in enclosures if a large magnitude is applied. This adverse effect is more obvious if an excessive amount of absorbent material is stuffed into enclosures in an attempt to extend the base reproduction range.
- b. Absorbency of absorbent materials is frequency-dependent. So, they color sound reproduced by the speakers, representing the absorbent's characteristics. Generally, short wavelengths, or high frequency sounds, can be absorbed but mid- and bass sound cannot, causing disturbance in attenuation characteristics.

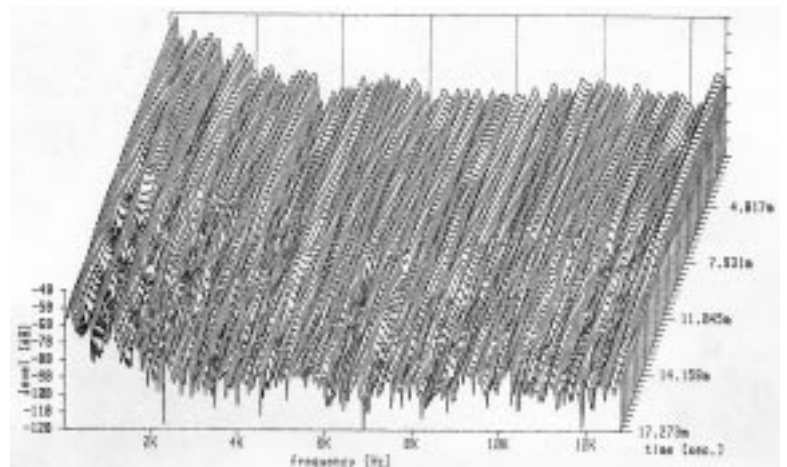

Figure15 without glass wool and HP reflector

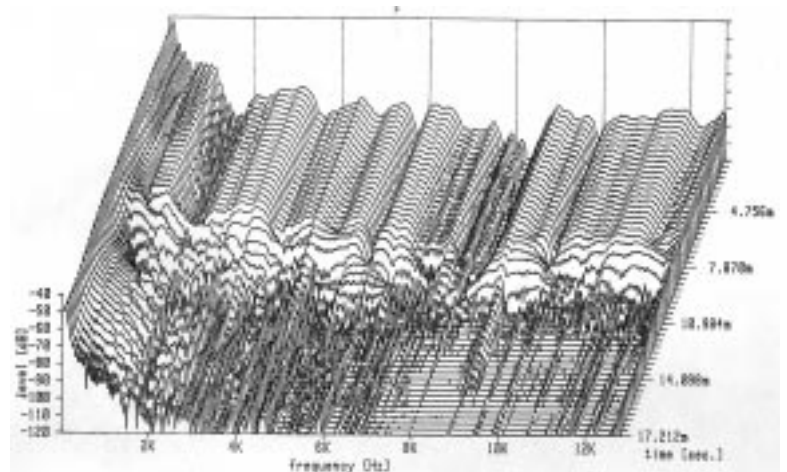

Figure16 involves glass wool. Effective attenuation occurs to high frequency sound only. Bass sound is attenuated only minimally and abruptly, with disturbance resulting.

## 4) Introduction of HP sound reflectors

To solve issues related to sound absorbents, we developed a new means where an HP system reflector is employed to prevent generation of standing waves in enclosures.

The idea is to have the sound present in enclosures to be extinguished naturally by making it reflected diffusely, creating conditions in which no standing waves may develop. Given below is a comparison of sound pressure characteristics occurring in enclosures.

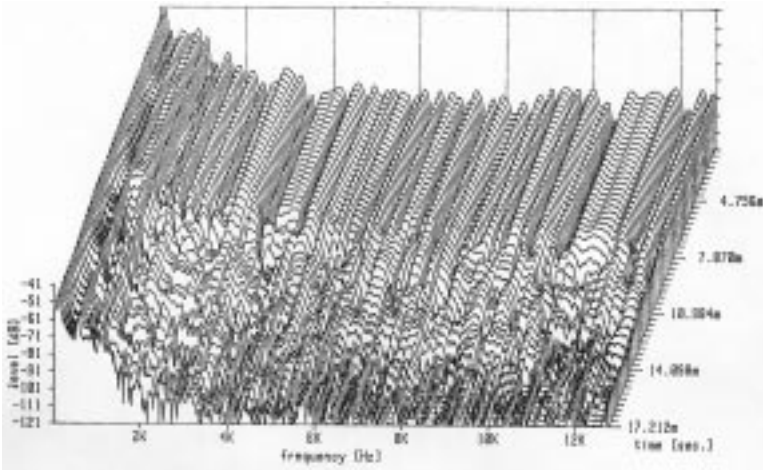

Figure17

Figure 17 shows a case where an HP reflector is located on 3 of the interior faces of the enclosure. The use of the HP system permits time-dependent attenuation to occur gradually and consistently after a 10 m second period over the entire sound spectrum.

### 5) Factors required of HP sound reflectors

Consistently varying third-order curved surfaces are ideal to cause and maintain regularly diffused reflection. For such curved surfaces to be realized, nothing can be better than the HP structure. Minimization of self-resonance inherent to reflectors is also a requisite, for which a configuration in which strength can be assured is an important factor. The HP structure is also very well suited in this sense.

Materials are to exhibit great strength and large internal loss. To meet these requirements, composite materials of carbon fibers and PBO, compatible with those of diaphragms, are used.

### 6) New bass-reflex system

To attain dynamism and massiveness in base response, bass-reflex enclosures are adopted. With NF-1, acoustic conversion of extremely low loss is achieved by the active utilization of reverberant sound caused by the interior HP sound reflector and exited through the bass-reflex ports. For this, ports are located at two places between the woofer and tweeter to allow for smooth and natural blending of the sound exiting through said ports with the sound coming directly from the drivers. Figure 18 shows woofer response characteristics in comparison with a glass wool case. It is obvious from the figure that the sound pressure level is 2 dB higher, assisted by utilization of sound created behind the diaphragm.

Furthermore, bass reproduction capability at around  $f_0$  is 3 dB higher when an HP sound reflector is

used.

This has listeners perceive the sound to be very rich, as if they are listening to a larger sized speaker. As a matter of fact, the response curve represents ideal characteristics.

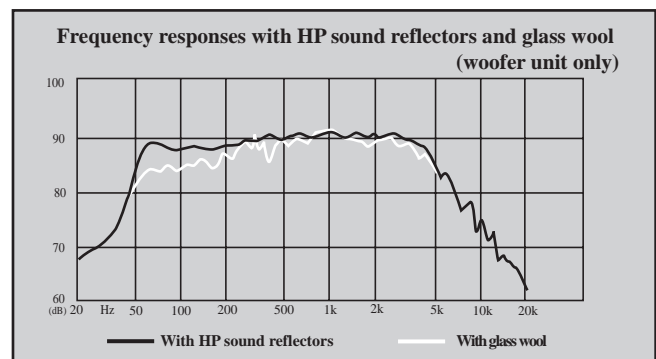

Figure18

### 1) Network

The simpler the crossover networks for woofers and tweeters, the better. An ultimate incarnation of this formula, i.e., non-use of any network element, is a reality with the woofer. The tweeter is connected through a capacitor for a 6 dB/octave attenuation. This achievement is possible simply because of smooth roll-off of the woofer at the high end, which no technologies other than the HP technology can achieve.

The use of a high quality film capacitor and a 1.5 mm diameter solid wire is another factor for this superb transition.

### 2) Bi-wiring

Successful achievement of our targets set for NF-1 listed below requires use of a bi-wiring system.

- a. For ideal driving of speakers, a 4-terminal structure is necessary to allow for independent connections.
- b. To enable connection of a single amplifier to each speaker driver, with a wire most appropriate for each speaker.
- c. To allow to attain, by reversing the phase, characteristics most suitable for the specific listening environment.

Bi-wiring systems permit creation of conditions most appropriate for driving speakers, using 2 identical or different amplifiers. If these are the case, remove the short bars present between the woofer and tweeter terminals.

## TECHNICAL SPECIFICATIONS

**Frequency response (in-phase connection)**

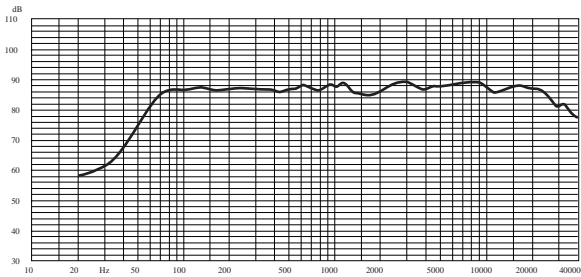

**Frequency response (directivity)**

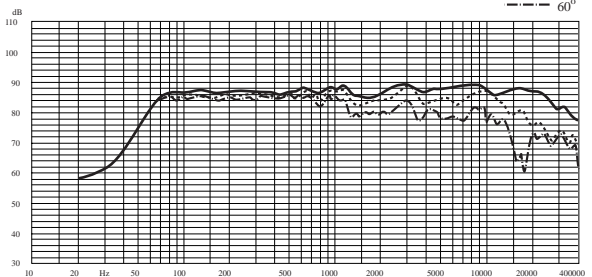

**Frequency response (opposite phase connection)**

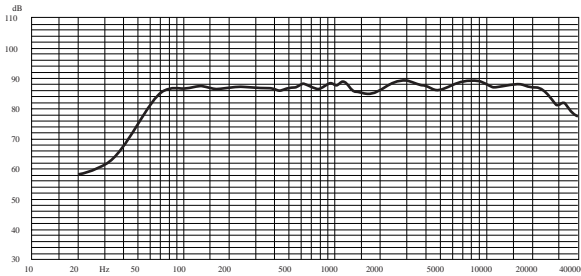

**Distortion**

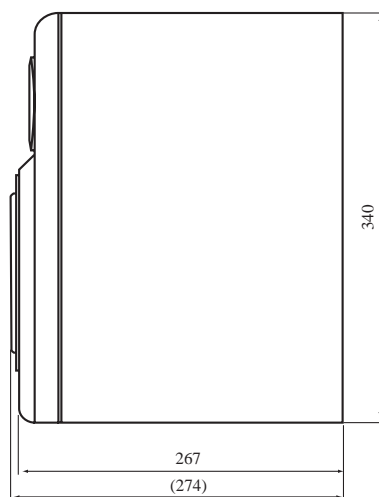
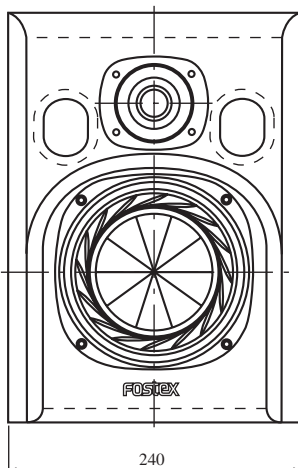
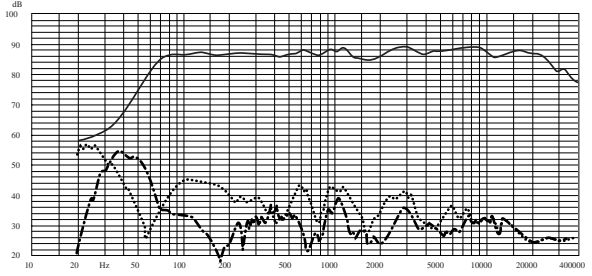

Impedance:	8 ohms
Frequency Range:	60~40k(Hz)
Sensitivity:	89dB/W(1m)
Power Handling (program):	100W
Weight:	9.1kg
Crossover:	12kHz

