

DV40 Owner's Manual <V1.1 Supplement>

The DV40 software has been upgraded to Version 1.1. This owner's manual supplement describes newly added and changed functions on the V1.1 software.

For basic operations and functions, refer to the DV40 owner's manual.

Contents

1. New UTILITY Menu “Edit Volume Lbl (Edit Volume Label)?”	3
1-1. Editing VOLUME LABEL	3
1-2. Renaming VOLUME LABEL Recognized as “REEL NUMBER”	4
2. New UTILITY Menu “Set SCENE&REEL (Set SCENE & REEL No.)?”	6
3. Change on “TC UBIT SEL” TC SETUP Menu	7
3-1. Selecting “SRNo.” as TC UBIT Information	7
3-2. Selecting “MDYf” as TC UBIT Information	8
3-3. Selecting “DMYf” as TC UBIT Information	8
4. New SETUP Menu “F.Name MD (File Name Mode)?”	9
5. New SETUP Menu “DefaultFileName (Default File Name)?”	10
6. LIST PLAY Function	11
6-1. Turning On LIST PLAY Mode	12
6-2. Confirming Linked Files	13
6-3. Reprogramming PLAY LIST	14
6-4. Locating to Beginning of PLAY LIST	14
6-5. Locating to End of PLAY LIST	14
7. Use of PS/2 Keyboard	15
7-1. Valid and Invalid keys	15
7-2. DV40 & PS/2 Keyboard Key Correspondence	15
8. FTP SERVER FUNCTION	16
8-1. Connection	16
8-2. FTP Command Compliance	16
8-3. Saved File Location	17
8-4. FTP Client Application	17
8-5. Checking TCP/IP Menus	17
8-6. Changing the TCP/IP Setting	19
9. Deletion of “Running Time?” SETUP Menu	21
10. LIST of SETUP / UTILITY / TC SETUP MENU	22
10-1. SETUP Menu	22
10-2. UTILITY Menu	23
10-3. TC SETUP Menu	23

1. New UTILITY Menu “Edit Volume Lbl (Edit Volume Label)?”

The “VOLUME LABEL” is a name which is used to identify a disk. It is normally named when formatting a disc. As mentioned in the DV40 Owner’s Manual page 1-5, the default name of VOLUME LABEL to be attached to the DVD-RAM disk is “DV40-DVD”. This UTILITY menu has been newly added so that the VOLUME LABEL can be changed even after formatting the DVD-RAM disk used on DV40. The followings are the procedures explaining about changing the default VOLUME LABEL “DV40-DVD” of the preformatted DVD-RAM disc.

1-1. Editing VOLUME LABEL

1) While the unit is in STOP mode, press the [SHIFT] key and then [SETUP] key to enter the UTILITY mode.

2) Rotate the jog dial or press the [SKIP/CURSOR <<] / [SKIP/CURSOR >>] key to select the “Edit Volume Lbl?” menu.

“?” is flashing on the DV40 FL display.



3) Press the [ENTER/YES] key.

Presume that the default VOLUME LABEL “DV40-DVD” is displayed. The first character “R” is flashing.

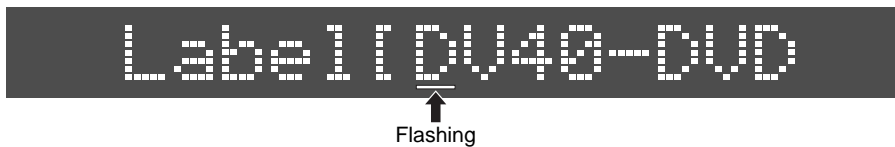

4) Press the [MARGIN RESET / CLR] key several times to erase all the alphanumeric characters named as a VOLUME LABEL.

Regardless of flashing alphanumeric character position, pressing the [MARGIN RESET / CLR] key several times will erase all the VOLUME LABEL characters.

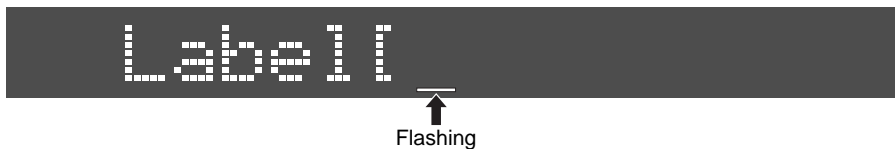

Then, use the alphanumeric keys to rename the VOLUME LABEL. In the case only a couple of characters are to be modified, instead of pressing the [MARGIN RESET / CLR] several times, moving the cursor by the [SKIP/CURSOR <<] and [SKIP/CURSOR >>] keys to a desired position and rotating the jog dial is more convenient.

Presume that “DV40-002” is named as a new VOLUME LABEL.



5) Press the [ENTER/YES] key.

Pressing the [ENTER/YES] key will rename the VOLUME LABEL of the DVD-RAM disk put in the DV40 DVD-RAM drive as “DV40-002”. After pressing the [ENTER/YES] key, “Edit Volume Lbl?” will be displayed again. (“?” is flashing.)

6) Press the [EXIT/NO] key or [STOP] key.

Pressing the [EXIT/NO] key or [STOP] key goes back to the normal display.

CAUTION

There is a limitation on the number of maximum alphanumeric characters on the VOLUME LABEL recognized by WINDOWS 98/NT, Macintosh computer and UDF standards as follow.

WINDOWS 98/NT: 10 characters
Macintosh: 27 characters
UDF Standards: 127 characters

Considering the usage of DVD-RAM disc in both the WINDOWS and Macintosh platforms, naming up to 10 characters of VOLUME LABEL would be recommended.

1-2. Renaming VOLUME LABEL Recognized as “REEL NUMBER”

The “REEL NUMBER” is put on each tape (file in the case of DV40) and is used to identify a tape (file) with time code information. Putting a REEL NUMBER is substantial when creating a EDL (Edit Decision List). By adding “-XXX (XXX: 000 ~ 999)” after a name, the section “XXX” is recognized as a REEL NUMBER.

VOLUME LABEL: #####-XXX (#####: Name)
(XXX: REEL NUMBER. 000 ~ 999)

CAUTION 1

Due to the limitation of the number of alphanumeric characters used for VOLUME LABEL recognized on Windows OS, using up to 10 alphanumeric characters including the 3-digit REEL NUMBER are recommended.)

CAUTION 2

The REEL NUMBER XXX is just a character string. Please remember that it does not roll over to the next digit or roll back to the previous digit.

The following is an example of renaming the VOLUME LABEL to be recognized as a “REEL NUMBER”.

- 1) While the unit is in STOP mode, press the [SHIFT] key and then [SETUP] key to enter the UTILITY mode.**
- 2) Rotate the jog dial or press the [SKIP/CURSOR <<] / [SKIP/CURSOR >>] key to select the “Edit Volume Lbl?” menu.**
- 3) Press the [ENTER/YES] key.**

Presume that the default VOLUME LABEL “DV40-DVD” is currently set.

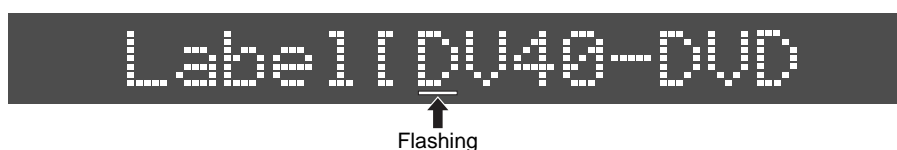

4) Press the [MARGIN RESET / CLR] key several times to erase all the alphanumeric characters “DV40-DVD”.

Regardless of flashing alphanumeric character position, pressing the [MARGIN RESET / CLR] key several times will erase all the VOLUME LABEL characters. Then, use the alphanumeric keys to rename the VOLUME NAME. Presume that “DV40-008” is named as a new VOLUME LABEL.

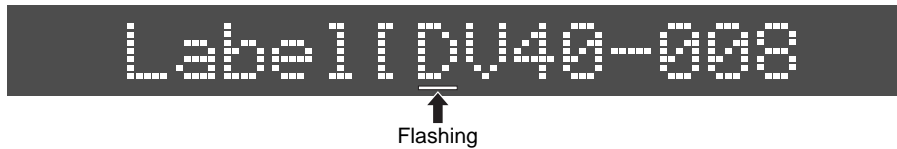

5) Press the [ENTER/YES] key.

By the press of [ENTER/YES] key, “Edit Volume Sel?” starts flashing.

6) Press the [EXIT/NO] or [STOP] key.

Pressing the [EXIT/NO] key goes back to the normal display. If “SRNo.” is selected in the “TC UBIT Sel?” menu explained in the section 3. Change on “TC UBIT SEL” TC SETUP Menu, the “REEL NUMBER: 008” will be output as a TC UBIT information.

NOTE 1

The REEL NUMBER set in the “Edit Volume Lbl?” UTILITY menu interlocks with the REEL NUMBER set by another UTILITY menu “Set REEL&SCENE?” which will be explained in the section 2. New UTILITY Menu “Set SCENE&REEL?”. The latter REEL NUMBER set by either UTILITY menu is going to be the one to be sent out as a TC UBIT information when the “SRNo.” is selected in the “TC UBIT Sel?” TC SETUP menu.

NOTE 2

When formatting the DVD-RAM disk, renaming the VOLUME LABEL with 3-digit number (e.g. DV40-005) from the default name (DV40-DVD) is possible, so that the 3-digit number can be recognized as a REEL NUMBER which allows to output as a TC UBIT information.

2. New UTILITY Menu “Set SCENE&REEL (Set SCENE & REEL No.)?”

This UTILITY menu has been newly added so that the SCENE NUMBER as well as the REEL NUMBER on each file created on DV40 can be set. The SCENE / REEL NUMBERS set by this UTILITY menu can be sent out as a TC UBIT information when “SRNo.” is selected in the “TC UBIT Sel?” TC SETUP menu. The followings are the procedures explaining about changing the SCENE / REEL NUMBER.

- 1) While the unit is in STOP mode, press the [SHIFT] key and then [SETUP] key to enter the UTILITY mode.
- 2) Rotate the jog dial or press the [SKIP/CURSOR <<] / [SKIP/CURSOR >>] key to select the “Set SCENE&REEL?” menu.
“?” is flashing on the DV40 FL display.



- 3) Press the [ENTER/YES] key.

The SCENE NUMBER “00000” starts flashing by the press of [ENTER/YES] key.

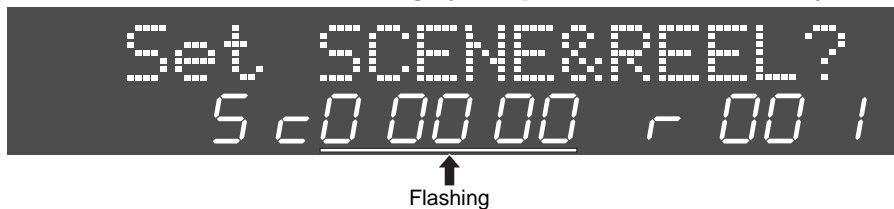

Select either the SCENE NUMBER or the REEL NUMBER by the [SKIP/CURSOR <<] / [SKIP/CURSOR >>] key and rotate the jog dial / use the alphanumeric keys to set a desired number. The following example shows that the SCENE NUMBER is set to “00005” and the REEL NUMBER “002”.



- 3) Press the [ENTER/YES] key.

By pressing the [ENTER/YES] key, the SCENE NUMBER and the REEL NUMBER are set to “00005” and “002” respectively. Also these values can be sent out as TC UBIT information.

NOTE

The REEL NUMBER set in the “Set REEL&SCENE?” UTILITY menu interlocks with the REEL NUMBER set by another UTILITY menu “Edit Volume Lbl?” explained in the section 1-2. Renaming VOLUME LABEL Recognized as “REEL NUMBER”. The latter REEL NUMBER set by either UTILITY mode is going to be the one to be sent out as a TC UBIT information when “SRNo.” is selected in the “TC UBIT Sel?” TC SETUP menu.

3. Change on “TC UBIT SEL” TC SETUP Menu

This menu allows to select the TIMECODE UBIT information attached to the TIMECODE output from DV40. In addition to the current selection “MDYf” (Month/Day/Year/File No.) and “DMYf” (Day/Month/Year/File No.), “SRNo” (S: Scene, R: Reel) is newly added on the V1.1 software. The date information on “MDYf” and “DMYf” is taken out from the internal clock on DV40 and is based on the time when the file is created. “SRNo” information is derived from the 3-digit REEL NUMBER attached to the VOLUME LABEL set in the “Edit VOLUME Lbl?” UTILITY menu or SCENE / REEL NUMBER set in the “Set SCENE&REEL?” menu. To select the TC UBIT information, follow the procedures below.

1) Press the [SHIFT] key and then [CHASE] key to enter the TC SETUP mode.

2) Rotate the jog dial or press the [SKIP/CURSOR <<] / [SKIP/CURSOR >>] key to select the “TC UBIT Sel?” menu.

The default setting of TC UBIT information is “SRNo”. The following appears on the DV40 FL display. (“?” flashes.)



3) Rotate the jog dial to select a desired TC UBIT information and press the [ENTER/YES] key.

Pressing the [ENTER/YES] key allows to select the TC UBIT information attached to the TC output from DV40. The UBIT information you can select is the one among “MDYf”, “DMYf” and “SRNo” (default setting).

3-1. Selecting “SRNo.” as TC UBIT Information

Rotate the jog dial and select “SRNo.” in the “TC UBIT Sel?” menu. (“SRNo.” is flashing.) Then, press the [ENTER/YES] key.



If “SRNo.” is selected, the following 8-digit TC UBIT information derived from the 3-digit REEL NUMBER attached to the VOLUME LABEL set in the “Edit Volume Lbl?” UTILITY menu or the SCENE / REEL NUMBER set in the “Set SCENE&REEL?” UTILITY menu will be output.

SSSSRRR SSSSS: SCENE No. derived from “Set SCENE&REEL?” UTILITY menu + File No.
 RRR: 3-digit REEL No. derived from “Edit Volume Lbl?” UTILITY menu or “Set SCENE&REEL?” UTILITY menu

• Example No.1

VOLUME LABEL: DV40-002
 SCENE / REEL No.: 00000 / 002
 File No.: 001



TC UBIT Information: 00001002

• Example No.2

VOLUME LABEL: DV40-005
 SCENE / REEL No.: 00006 / 005
 File No.: 002



TC UBIT Information: 00008005

3-2. Selecting “MDYf” as TC UBIT Information

Rotate the jog dial and select “MDYf” in the “TC UBIT Sel?” menu. (“MDYf” is flashing.) Then, press the [ENTER/YES] key.



If “MDYf” is selected, the following 8-digit TC UBIT information based on the date when the file is originally created will be output.

MMDDYYff MM: Month by 2-digit (01 ~ 12)
 DD: Day by 2-digit (01 ~ 31)
 YY: Year by 2-digit (00 ~ 99)
 ff: File No. by 2-digit in hexadecimal (01 ~ C7)

• Example No.1

File No.: 001
Created date: July 4, 2002



TC UBIT Information: 07040201

• Example No.2

File No.: 184
Created date: December 23, 2005



TC UBIT Information: 122305B8

3-3. Selecting “DMYf” as TC UBIT Information

Rotate the jog dial and select “DMYf” in the “TC UBIT Sel?” menu. (“DMYf” is flashing.) Then, press the [ENTER/YES] key.



If “DMYf” is selected, the following 8-digit TC UBIT information based on the date when the file is originally created will be output.

DDMMYYff DD: Day by 2-digit (01 ~ 31)
 MM: Month by 2-digit (01 ~ 12)
 YY: Year by 2-digit (00 ~ 99)
 ff: File No. by 2-digit in hexadecimal (01 ~ C7)

• Example No.1

File No.: 001
Created date: 6 June, 2001



TC UBIT Information: 06060101

• Example No.2

File No.: 169
Created date: 15 November, 2007



TC UBIT Information: 151107A9

4. New SETUP Menu “F.Name MD (File Name Mode)?”

The file on DV40 with a previous software version is named based on the DATE information such as “B09h51m29s14feb2002.wav” and “S09h53m25s14feb2002.sd2”. From the V1.1 software, the SETUP menu “F.Name MD?” has been newly added to DV40, which allows to select the file name as either DATE or TAKE. The newly added “TAKE” mode names files with 3-digit automatic incremental number attached every time a file is newly created.

Refer to the following explanations for selecting a File Name Mode.

1) Press the [SETUP] key to enter the SETUP mode.

2) Rotate the jog dial or press the [SKIP/CURSOR <<] / [SKIP/CURSOR >>] key to select the “F.Name MD?” menu.

The default File Name Mode is “DATE”. The following appears on the DV40 FL display. (“?” flashes.)



3) Press the [ENTER/YES] key.

By pressing the [ENTER/YES] key, you can select either the DATE or TAKE File Name Mode. In this condition, “DATE (Default setting)” is flashing.



4) Rotate the jog dial to select either the File Name Mode.

Rotating the jog dial C.W. selects the “TAKE” and C.C.W. selects the “DATE” mode. The example below indicates that the “TAKE” mode is selected.



5) Press the [ENTER/YES] key.

Pressing the [ENTER/YES] key defines the File Name Mode. In the above example, the “TAKE” File Name Mode is selected.

6) Press the [EXIT/NO] key or the [STOP] key.

Pressing the [EXIT/NO] key or the [STOP] key goes back to the normal display.

CAUTION

In order to name the file with 3-digit automatic incremental number attached every time a file is newly created, the “TAKE” File Mode must be selected in the “F.Name MD?” and the file itself must be properly named as well. The way to name the file is explained in the section 5. New SETUP Menu “DefaultFileName?”.

If the file is not named in the “DefaultFileName?” SETUP menu properly, the file will be named based on the DATE information.

5. New SETUP Menu “DefaultFileName (Default File Name)?”

This is the SETUP menu newly added on DV40 with the V1.1 software. This menu should be used to name a file with 3-digit automatic incremental number every time it is newly created. This mode becomes valid when the “TAKE” File Name Mode is selected.

Refer to the following explanation for inputting a Default File Name.

1) Press the [SETUP] key to enter the SETUP mode.

The following appears on the DV40 FL display. (“?” flashes.)



2) Press the [ENTER/YES] key.

The following appears on the DV40 FL display. (“_” flashes.)



3) Input a desired file name.

Using alphanumerical keys, jog dial and [SKIP/CURSOR >>] / [SKIP/CURSOR <<] key, input a desired name. The following example names the file as “DV40”.



4) Press the [ENTER/YES] key.

By pressing the [ENTER/YES] key, the file name is defined as “DV40” and 3-digit number “-001” starts flashing.



CAUTION

When naming a file using a PS/2 keyboard, be careful about the use of special characters. The file name with the following characters are not correctly recognized by the Windows OS platform.

“ / ”, “ ? ”, “ . ”, “ < ”, “ > ”, “ | ”, “ ¥ ”, “ - ”

Remember that the 1st character of the file name must start from an alphabet and the following use only ASCII characters. Although up to 247 numbers of characters can be used as a file name, the maximum number of characters recognized by SDII and BWF specifications are 23 and 55 respectively.

5) Set the 3-digit number.

Set the 3-digit number by rotating the jog dial and / or using the 10 alphanumeric keys (001 ~ 999). The input 3-digit number sets the number attached to the default file name. The following example sets the default file name as “DV40-005”.

6) Press the [ENTER/YES] key.

Pressing the [ENTER/YES] key sets the default file name as “DV40-005”.

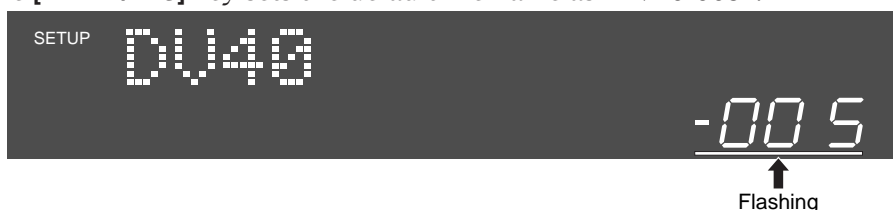

7) Press the [EXIT/NO] key or [STOP] key.

“DefaultFileName?” appears again. Pressing the [EXIT/NO] key or [STOP] key goes back to the normal display.

By the above procedures, the default file name is set to “DV40-005”. If the “TAKE” File Name Mode is selected, every time a file is newly created, it will be named as “DV40-5”, “DV40-6”, ... “DV40-9”, “DV40-10”, “DV40-11”, ... “DV40-99”, ... “DV40-100”, “DV40-111”, ... “DV40-999”.

6. LIST PLAY Function

The LIST PLAY function allows to link multiple audio files recorded by the same condition (e.g. TR MODE, Fs, AUDIO FILE) and reproduce the files continuously while maintaining TC continuity. There are two LIST PLAY modes; One is the “LTC_Link” and the other the “SongLink” available on DV40.

LTC_Link

In the “LTC_Link” mode, based on the recorded LTC Start Time in each file, multiple files are linked and reproduced continuously. This mode should be used when the LTC address has to be matched in conjunction with other equipment such as a video camera.

SongLink

The “SongLink” mode links audio files in the file number ascending order (e.g. file No.1 -> file No.2 -> file No.3 ...). LTC Start Time will be set according to the one recorded in the first link file (default setting: 01h00m00s00f) and the LTC will be jammed regardless of recorded LTC Start Time in the following linked files. This mode is convenient when reproducing multiple audio files continuously.

CAUTION 1

In order to link multiple audio files recorded on DV40, each SW setting, audio file format (BWF or SDII), sampling frequency, resolution (quantization bits) and track mode (mono, stereo or multi) must be the same in all the files to be linked.

CAUTION 2

The message “<<Silent Area>>” indicating no audio to be reproduced exists will be displayed on the DV40 FL display when in the following condition.

- If there is an overlapping LTC address between the files in the LTC_Link mode, <<Silent Area>> is displayed while reproducing the overlapped latter file.
- There are hidden files (deleted files) in the LTC_Link mode.
- When the last linked file finishes reproducing.

Presume that the following six files (including deleted File No. 5) recorded by the same condition (Fs, resolution, etc.) exist on the DVD-RAM disk.

File No.	001	002	003	004	005 (DELETED)	006
LTC Start Time	01h00m00s00f	01h01m00s00f	01h01m25s00f	01h02m00s00f	-	01h03m00s00f
Duration	30 sec	30 sec	30 sec	30 sec	-	30 sec

When executing the LIST PLAY function in the “LTC_Link” and “SongLink” mode, the linked files and the order are indicated in the drawing next page.

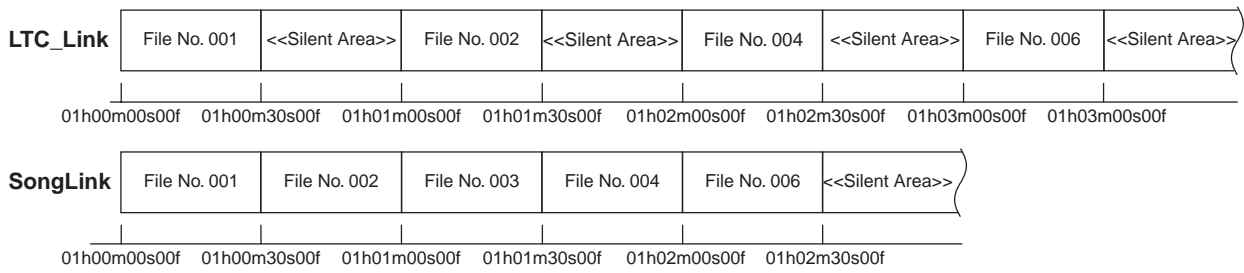

In the LTC_Link mode, there is a gap of LTC address (01h00m30s00f ~ 01h01m00s00f) between the File No. 001 and 002. Although LTC is continuously output in this section, <<Silent Area>> is displayed. There is an overlapping LTC address between the File No. 002 and 003. Since a smaller File No. has a priority, File No. 002 is reproduced and File No. 003 will not be reproduced. Thus, <<Silent Area>> is displayed from 01h01m30s00f ~ 01h02m30s00f. <<Silent Area>> is also displayed in the deleted File No. 005 LTC section (01h02m30s00f ~ 01h03m00s00f).

In the SongLink mode, DV40 just simply links the File No. 001 ~ 004 and 006 regardless of LTC START address setting on the File No. 002 ~ 004 and 006. Then, it reproduces each file continuously.

In both Link modes, DV40 keeps on playing and outputting LTC even after reproducing the last link file is completed. In this section, <<Silent Area>> is displayed.

Refer to the following explanation to turn on the LIST PLAY mode.

6-1. Turning On LIST PLAY Mode

1) Press the [LIST PLAY] key and rotate the jog dial.

When the [LIST PLAY] key is pressed, the following appears on the DV40 FL display. The default setting of the LIST PLAY mode is “LTC_Link”. By rotating the jog dial C.W., you can choose the “SongLink” mode.



2) Press the [ENTER/YES] key.

After pressing the [ENTER/YES] key, “<<Wait!>>” message starts flashing for a short while indicating that DV40 is creating a linked file list on the DV40 FL display. Then, the [LIST PLAY] key will be lit solid. This indicates that the selected LIST PLAY mode is turned ON.

3) Press the [PLAY] key.

Pressing the [PLAY] key allows to reproduce the linked multiple files.

NOTE

Pressing the [FILE SEL] key when the LIST PLAY mode is on allows to select either the “LTC_Link” or “SongLink” mode.

6-2. Confirming Linked Files

Pressing the [SKIP/CURSOR >>] or [SKIP CURSOR <<] key allows to locate to the beginning of each linked file in the ascending / descending order respectively. When the files 001 ~ 006 are linked as shown in the drawing below,

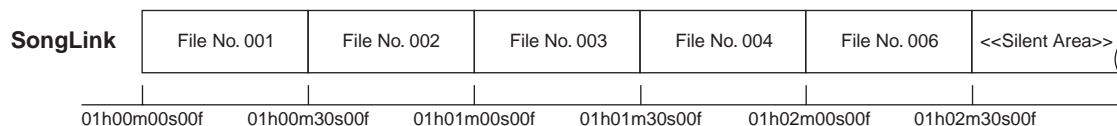

by pressing the [SKIP/CURSOR >>] or [SKIP CURSOR <<] key, the followings appear on the DV40 FL display.



Press [SKIP/CURSOR >>] key ↓ ↑ Press [SKIP/CURSOR <<] key

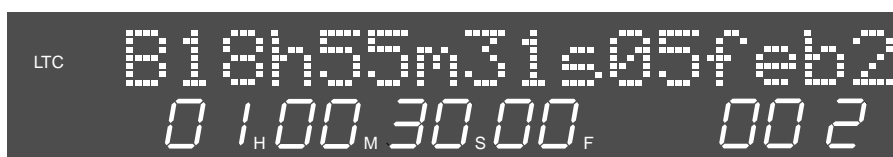

Press [SKIP/CURSOR >>] key ↓ ↑ Press [SKIP/CURSOR <<] key



Press [SKIP/CURSOR >>] key ↓ ↑ Press [SKIP/CURSOR <<] key



Press [SKIP/CURSOR >>] key ↓ ↑ Press [SKIP/CURSOR <<] key



6-3. Reprogramming PLAY LIST

If you find that there are unnecessary linked files exist, you can reprogram the PLAY LIST by deleting them.

1) Turn off the LIST PLAY mode.

If the LIST PLAY LED is lit solid, press the **[LIST PLAY]** key to turn the mode off.

2) Recall the File you would like to delete.

Press either the **[SKIP/CURSOR >>]** or **[SKIP CURSOR <<]** key and recall the file you would like to delete.

3) Press the [SHIFT] key and then [SETUP] key to enter the UTILITY Mode.

4) Rotate the jog dial or press the [SKIP/CURSOR <<] / [SKIP/CURSOR >>] key to select the “Delete File?” menu.

The following appears on the FL display. (“?” is flashing.)



5) Press the [ENTER/YES] key.

“Sure?” message starts flashing.



6) Press the [ENTER/YES] key.

The file is deleted.

CAUTION

Even after unnecessary files are deleted, they can be restored by the “Restore DelFile?” UTILITY menu. This indicates that the files have not been completely erased from the DVD-RAM disk yet. However, if you optimize the DVD-RAM disk by the “Optimize Disk?” UTILITY menu, deleted files are completely erased from the DVD-RAM disk. After optimizing, they can be no longer restored.

NOTE

A deleted file before optimizing on DV40 is categorized as a “hidden file”. It can be seen as a translucent file on a personal computer. (If the folder option “A hidden files are not displayed.” on the computer is selected, change the folder option setting to allow to display hidden files.) In the condition that the translucent hidden file can be seen on the computer, display the file property and uncheck the “check mark” on the “hidden file”. By doing so, you can restore the deleted file even on the computer.

6-4. Locating to Beginning of PLAY LIST

While the LIST PLAY mode is on (**[LIST PLAY]** key is lit), executing “LOCATE ABS0” (pressing the **<< REWIND]** key while holding down the **[STOP]** key) allows to locate to the beginning of the first linked file (the closest file to the LTC 00h00m00soof).

6-5. Locating to End of PLAY LIST

While the LIST PLAY mode is on (**[LIST PLAY]** key is lit), executing “LOCATE REC END” (pressing the **[F FWD >>]** key while holding down the **[STOP]** key) allows to locate to the end of the last linked file.

7. Use of PS/2 Keyboard

From the V1.00 software, a PS/2 keyboard can be used to input File Name, Volume Label, etc. Refer to the following explanation and the drawing for the correct usage of PS/2 keyboard.

7-1. Valid and Invalid keys

On the current software version, the translucent keys (gray) in the drawing below cannot be used. Other keys can be used to input File Name, Volume Label, etc. The keys which do not work are as follow.

- TAB, F2 ~ F12, Print Scrn, Scroll Lock, Pause, insert, Home, Page Up, Page Down, End

7-2. DV40 & PS/2 Keyboard Key Correspondence

On the current software version, the translucent keys (gray) in the drawing below are not working. Other keys can be used to input the File Name, Volume Label, etc. The keys which do not work are as follow.

TAB, F2 ~ F12, Print Scrn, Scroll Lock, Pause, insert, Home, Page Up, Page Down, End

• DV40 Front Panel & PS/2 Key Correspondence

Pressing the following key on the PS/2 keyboard is equivalent to the key manipulation on the DV40 front panel keys.

PS/2 Keyboard	→	←	↑	↓	ENTER	ESC
DV40 Key	SKIP/CURSORS>>	SKIP/CURSORS<<	Jog rotation (C.W.)	Jog rotation (C.C.W.)	ENTER/YES	EXIT/NO

• Accessing MENUs using ALT key

Pressing the following key while holding down the PS/2 [ALT] key allows to directly access the following menus.

PS/2 Keyboard	ALT + U	ALT + S	ALT + T
DV40 menu	UTILITY	SETUP	TC SETUP

• Recalling “Edit File Name?” menu

By the press of F1 key, the “Edit File Name?” UTILITY menu can be directly recalled.

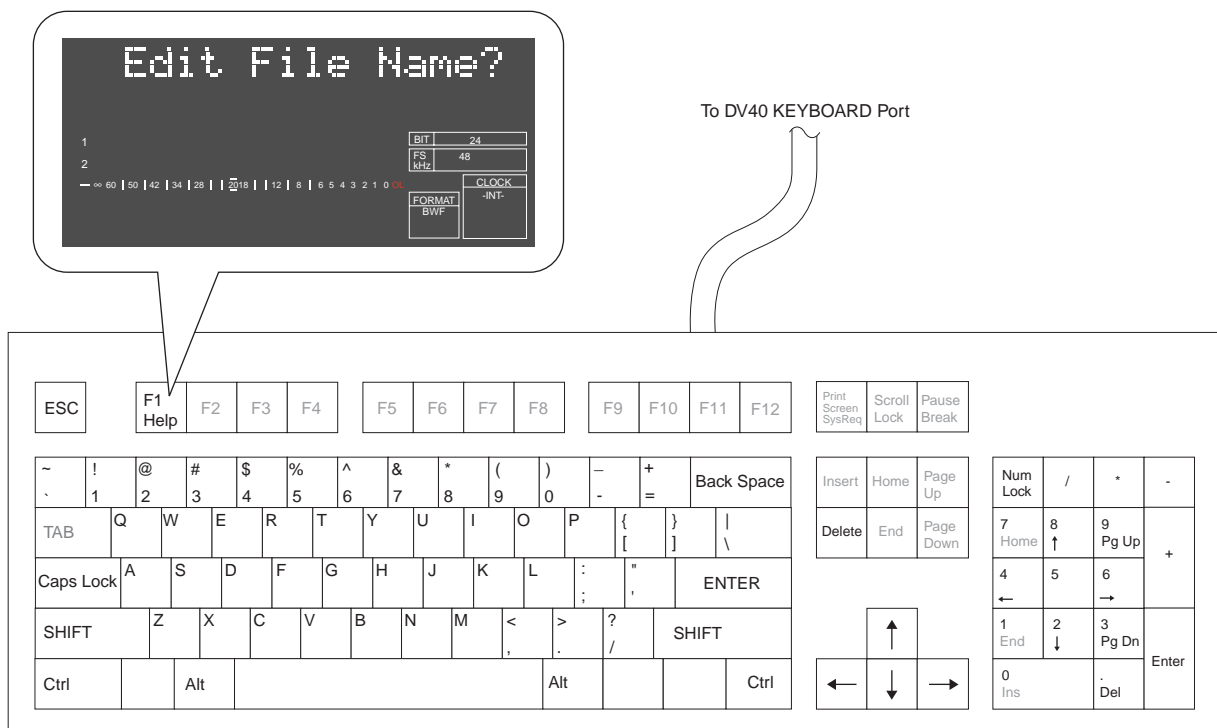

8. FTP SERVER FUNCTION

Working as a FTP (File Transfer Protocol) server, DV40 can send and receive BWF and SDII files to and from a client PC using TCP/IP (Transmission Control Protocol/Internet Protocol). When sending and receiving data, a FTP client application is required.

8-1. Connection

When connecting DV40 to a client PC, a “Category 5” cable which complies to 10BASE-T and 100BASE-TX must be used. If DV40 is directly connected to a client PC, a cross cable must be used. In the case DV40 is connected to a client PC via hub, a straight cable must be used. When DV40 recognizes a client PC, the “LINK LED” on the DV40 rear panel is lit solid.

< DV40 Direct Connection >

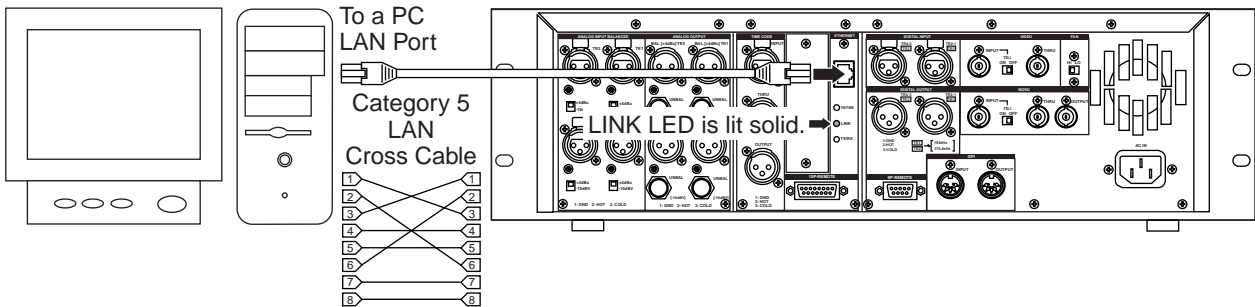

< DV40 Connection via Hub >

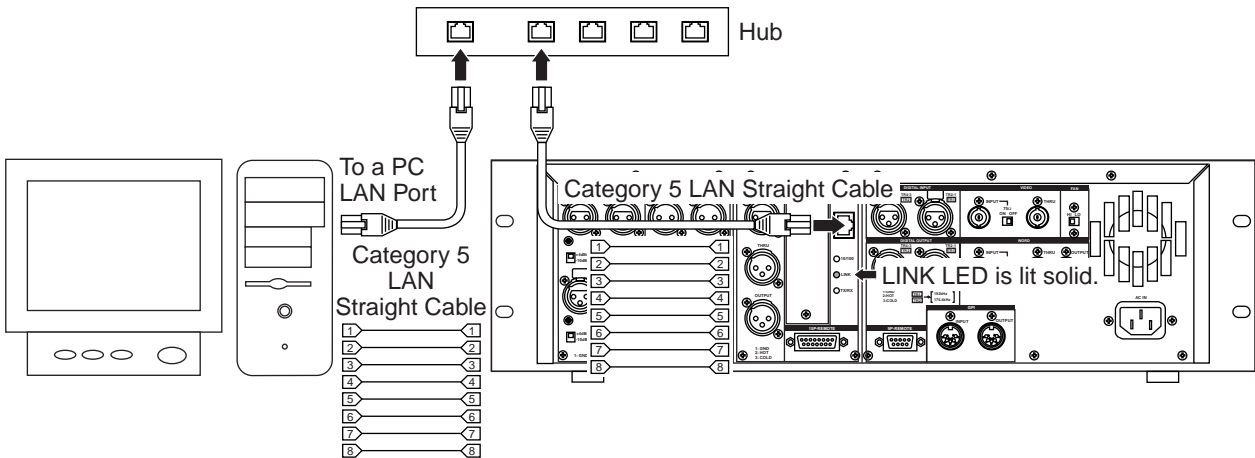

8-2. FTP Command Compliance

The following FTP commands can be used when DV40 works as a FTP server.

USER	Identifying user name.
PASS	Identifying password.
QUIT	Terminating FTP connection. TCP connection for Control is also cut off.
PORT	When transferring data, relay the connection state open port number for data transferring at client side to server. Format: PORT IP1, IP2, IP3, IP4, P1, P2 (IPx: IP address, Px: port number represented by decimal number in every 1 byte unit)
TYPE	Designating data type (ASCII, EBCDIC, BINARY, LOCAL).
RETR	Instructing server to transfer file through data connection.
STOR	Instructing server to write data transferred through data connection into a new file.
LIST	Requesting server to send a list of files.
NLST	Requesting server to send a detailed list of files.
CWD	Changing current directory.
CDUP	Changing current directory to upper level.
PWD	Displaying current directory.
NOOP	Doing nothing.
SYST	Acquire server OS type.

The following FTP commands cannot be used when DV40 works as a FTP server.

APPE	Instructing server to write data transferred through data connection into an existing file additionally.
DELE	Deleting designated file.
RNFR	Designating current file name for renaming.
RNTO	Changing current file name for renaming.
HELP	Displaying command description.
ACCT	Identifying user account.
PASV	Opening command state designated port except default data port (No. 20) on server.
STRU	Designating file structure.
MODE	Designating file transfer mode (Stream, Block, Compressed).
RMD	Deleting designated directory.
MKD	Creating designated directory.
STAT	Requesting server condition.

Note that

- Deleting files
- Renaming files
- Creating a new directory

cannot be executed when using a FTP client application.

8-3. Saved File Location

8-3-1. BWF File

The files recorded by BWF AUDIO FILE SW setting are saved in the “bwff” folder. Note that only a file with “.wav” extension can be saved in the “bwff” folder.

8-3-2. SDII File

The files recorded by SDII AUDIO FILE SW are saved in the “sd2f” folder. Note that the file type to send and received data is “MacBinary version 2”. Because of this, the “*.bin” file extension is added to a file name.

8-4. FTP Client Application^o

The FTP client applications we confirmed the operation are

- Fetch (Shareware for Macintosh computer)
- WS FTP (Shareware for Windows computer)

The FTP client application we found inoperative is

- FTP Explorer (Shareware for Windows computer)

8-5. Checking TCP/IP Menus

There are several menus in the TCP/IP settings on DV40. First, press the [SETUP] key and then rotate the jog dial. While the menu “TCP/IP Setting?” is displayed, press the [ENTER/YES] key.



By rotating the jog dial, the menu changes as shown below.

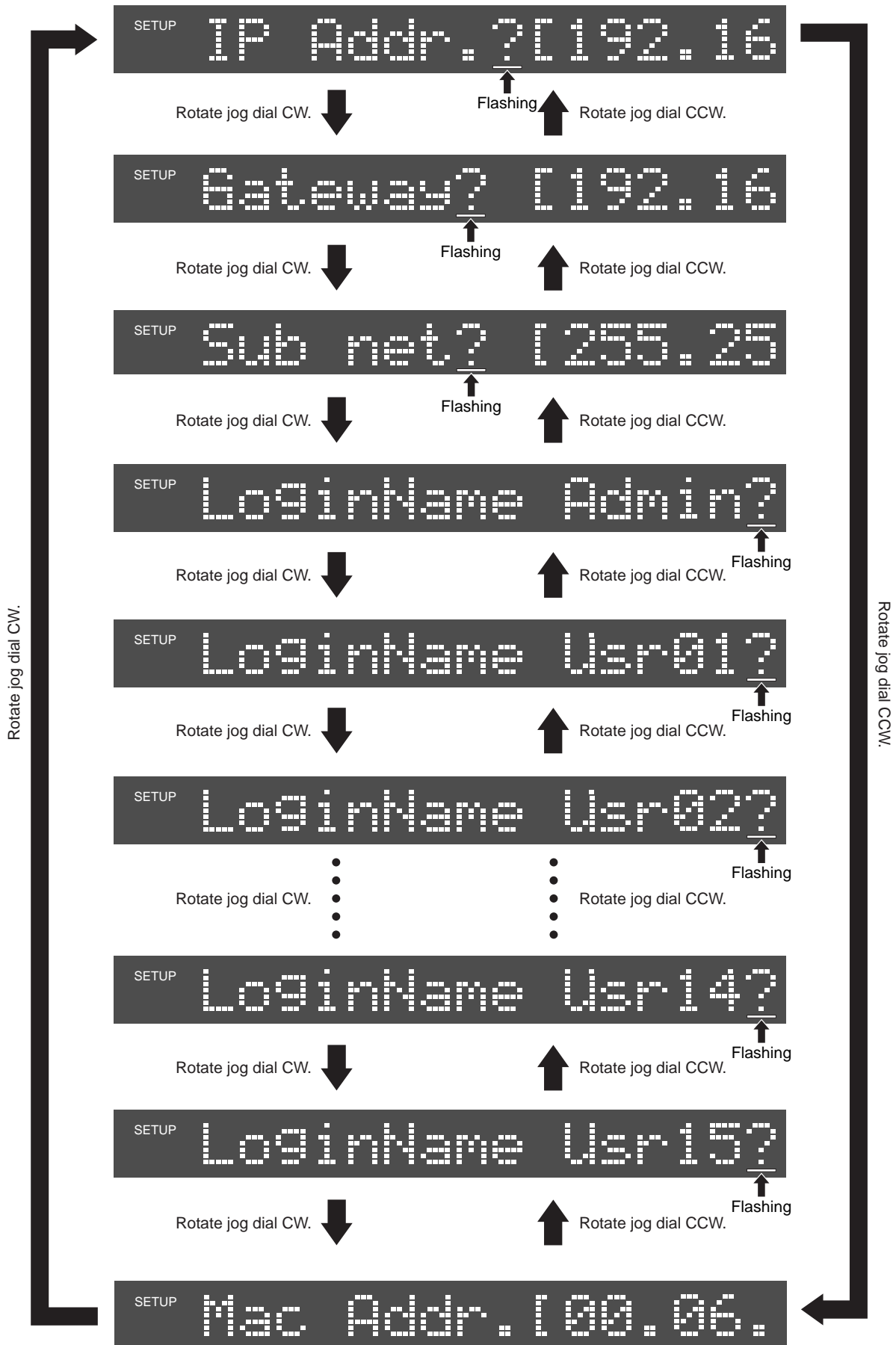

8-6. Changing the TCP/IP Setting

There are cases that the TCP/IP settings must be changed. For example, if 2 x DV40s exist in a single network environment, the IP Address on one of the DV40s must be changed. This section describes how to change the TCP/IP settings.

8-6-1. IP Address

The IP Address on DV40 is set in this menu.

- 1) Rotate the jog dial to select “IP Addr.?[192.16” and press the [ENTER/YES] key.

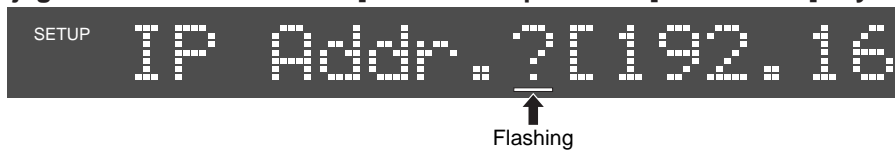

To check the full digits of IP address, press the [SKIP/CURSOR >>] key once. If you do so, the following will appear on the DV40 FL display.



Now you can see that the current IP Address setting on DV40 is [192.168.1.64].

- 2) Press the [ENTER/YES] key.

If the [ENTER/YES] key is pressed, the section “192” starts flashing.



- 3) Move the cursor and change the IP Address.

Move the cursor by the [SKIP/CURSOR >>] or [SKIP/CURSOR <<] key and rotate the jog dial to change the IP Address. The alphanumeric keys can be also used to change the IP Address.

- 4) Press the [ENTER/YES] key.

Pressing the [ENTER/YES] key defines the change on the IP Address.

8-6-2. Gateway

The Gateway should be set when the Gateway server exists in the network DV40 is connected. If there is no Gateway server exists, you do not have to set the Gateway.

- 1) Rotate the jog dial to select “Gateway? [192.16” and press the [ENTER/YES] key.

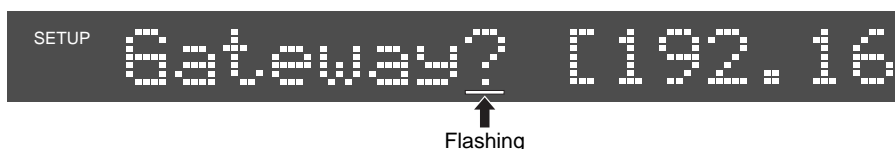

To check the full digits of IP address, press the [SKIP/CURSOR >>] key once. If you do so, the following will appear on the DV40 FL display.

Now you can see that the current IP Address setting on DV40 is [192.168.1.64].



2) Press the [ENTER/YES] key.

If the [ENTER/YES] key is pressed, the section “192” starts flashing.



3) Move the cursor and change the IP Address.

Move the cursor by the [SKIP/CURSOR >>] or [SKIP/CURSOR <<] key and rotate the jog dial to change the Gateway. The alphanumeric keys can be also used to change the IP Address.

4) Press the [ENTER/YES] key.

Pressing the [ENTER/YES] key defines the change on the Gateway.

8-6-3. Sub net

The Sub net mask value in the network DV40 exists should be set. In the case the Sub net mask is not used, you do not have to set this value.

1) Rotate the jog dial to select “Subnet? [255.25” and press the [ENTER/YES] key.

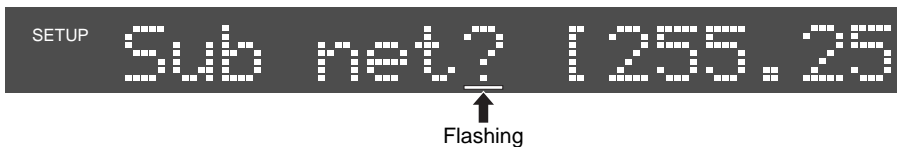

To check the full digits of Subnet, press the [SKIP/CURSOR >>] key once. If you do so, the following will appear on the DV40 FL display.

Now you can see that the current IP Address setting on DV40 is [192.168.1.64].



2) Press the [ENTER/YES] key.

If the [ENTER/YES] key is pressed, the section “192” starts flashing.



3) Move the cursor and change the IP Address.

Move the cursor by the [SKIP/CURSOR >>] or [SKIP/CURSOR <<] key and rotate the jog dial to change the Sub net value. The alphanumeric keys can be also used to change the IP Address.

4) Press the [ENTER/YES] key.

Pressing the [ENTER/YES] key defines the change on the Sub net value.

8-6-4. Login Name (Administrator)

Using the Login Name and the Password set in this menu, log in from a FTP client application.

1) Rotate the jog dial to select “LoginName Admin?” and press the [ENTER/YES] key.

The first letter “d” of default login name “dv40” starts flashing.

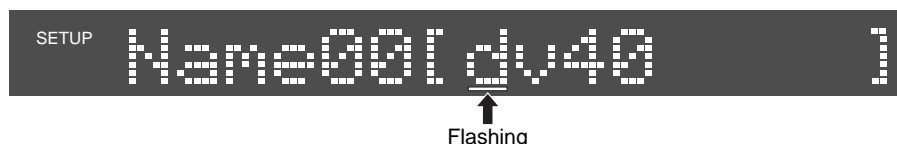

2) Press the [ENTER/YES] key.

Move the cursor by the [SKIP/CURSOR >>] or [SKIP/CURSOR <<] key and rotate the jog dial to change the Login Name to a desired one. The alphanumeric keys can be also used to change the Login Name.

3) Press the [ENTER/YES] key.

Pressing the [ENTER/YES] key defines the Login Name. Then, the first letter “d” of default password “dv40” starts flashing.

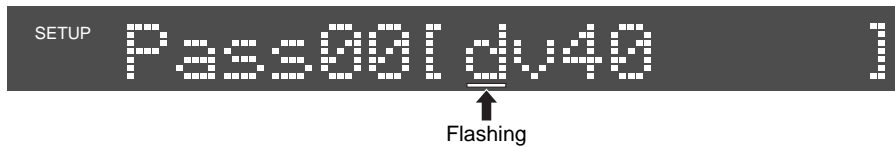

4) Move the cursor and change the IP Address.

Move the cursor by the [SKIP/CURSOR >>] or [SKIP/CURSOR <<] key and rotate the jog dial to change the Password to a desired one. The alphanumeric keys can be also used to change the Password.

5) Press the [ENTER/YES] key.

Pressing the [ENTER/YES] key defines the change on the Password.

6) Press the [EXIT/NO] key.

Pressing the [EXIT/NO] key goes back to the normal display.

8-6-5. Login Name (Usr01 ~15)

Set the Usr (User 01 ~15) Login Name and the Password in the same manner as explained in the section 8.6.4 LogIn Name.

8-6-6. MAC Address

The MAC (Machine Access Control) address is the 48-bit machine-specific fixed address, so that DV40 used in a network environment can be identified. It can be checked but not changed.

1) Rotate the jog dial and select “Mac Addr.[00.06.” .



1) Press the [SKIP/CURSOR >>] key several times.

Pressing the [SKIP/CURSOR >>] key several times allows to check the full digits of machine-specific MAC address. The MAC address of the example below is [00.06.64.01.00.14].



9. Deletion of “Running Time?” SETUP Menu

The SETUP menu “Running Time?” has been deleted on DV40 with V1.1 software onwards.

10. LIST of SETUP / UTILITY / TC SETUP MENU

There have been several changes in the SETUP / UTILITY / TC SETUP menu on DV40 with V1.1 software. To straighten up, the list of each menu is listed.

10-1. SETUP Menu

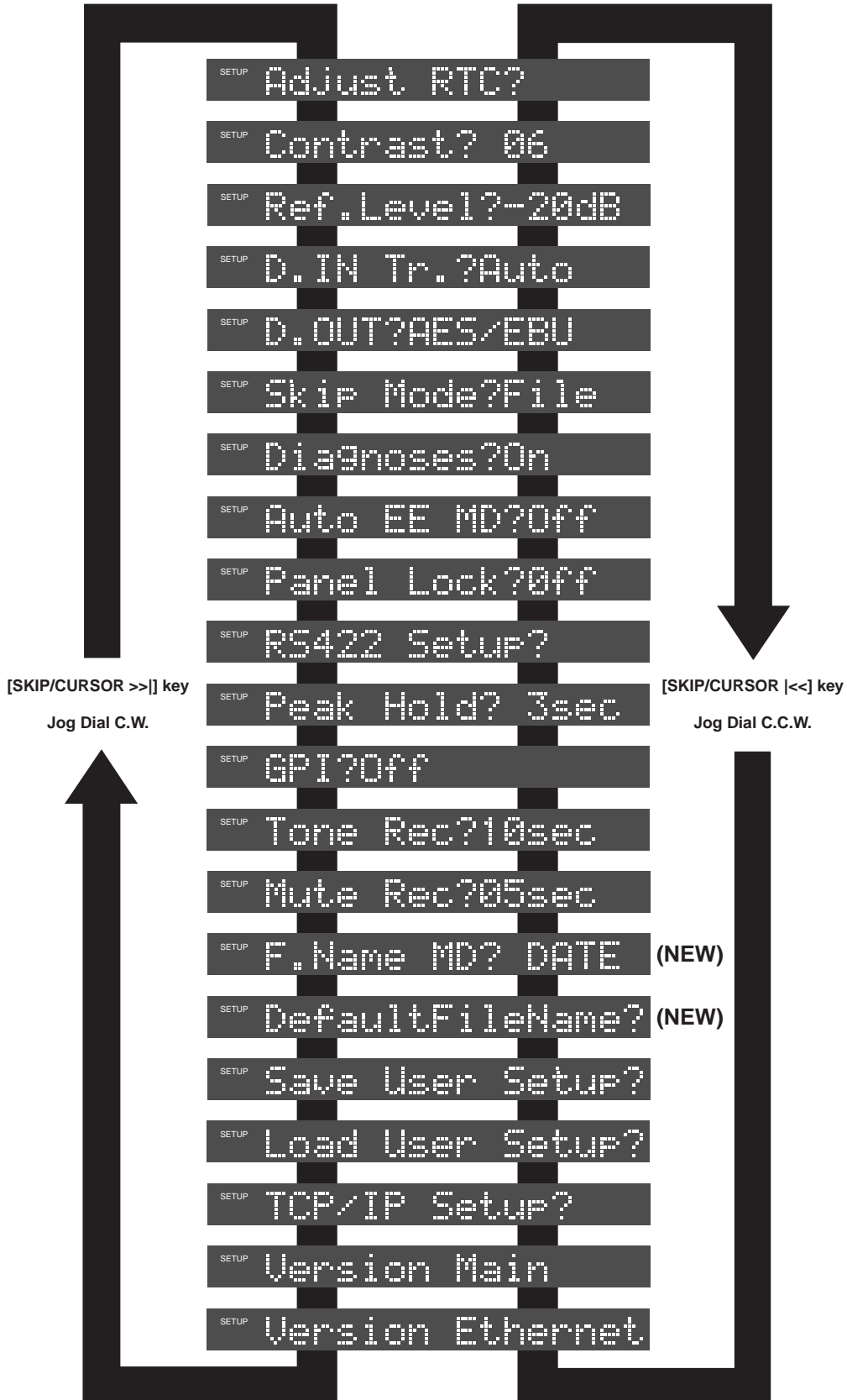

10-2. UTILITY Menu

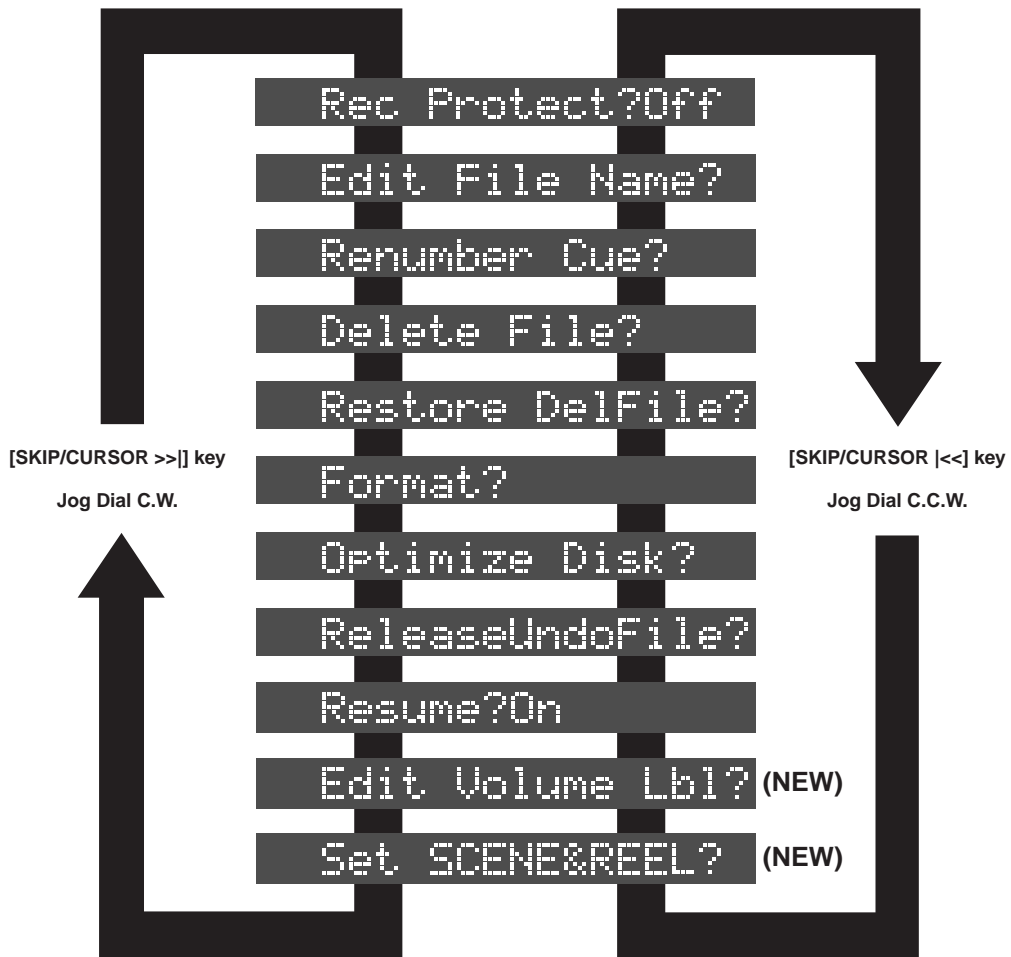

10-3. TC SETUP Menu

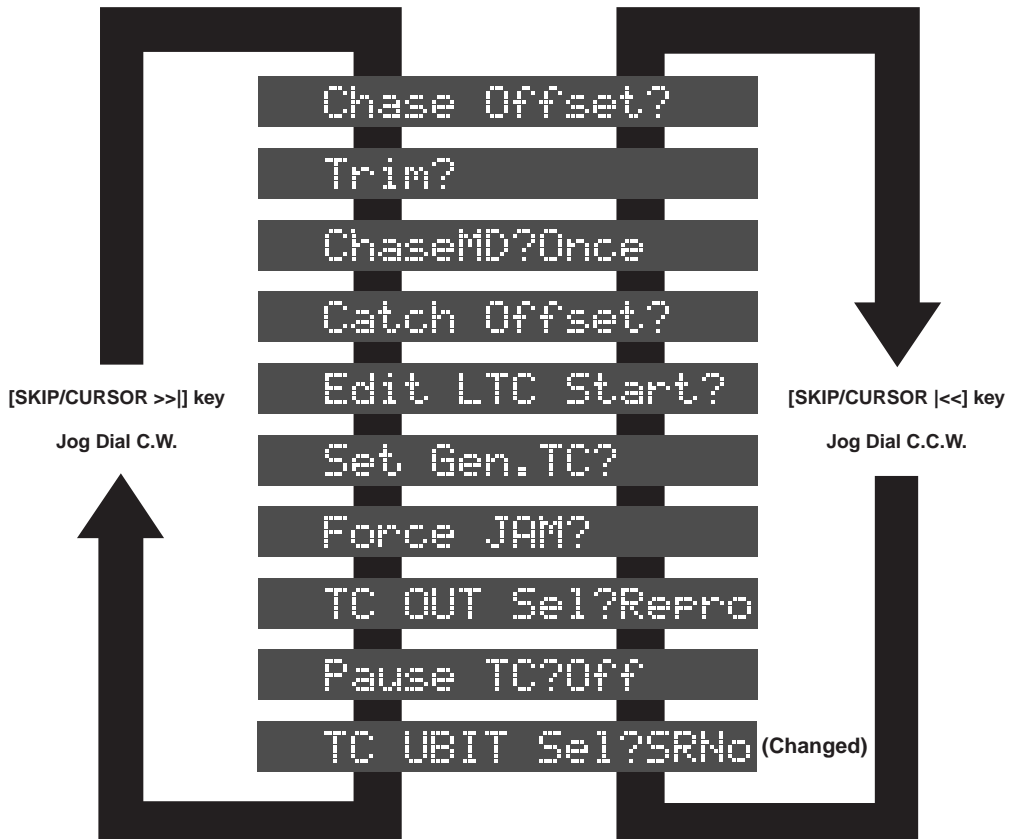

Fostex[®]

FOSTEX CORPORATION

3-2-35 Musashino, Akishima-shi, Tokyo, Japan, 196-0021

FOSTEX AMERICA

15431 Blackburn Ave., Norwalk, CA 90650, U. S. A.