



Owner's Manual

Model D-160

Digital Multitrack Recorder

Fostex[®]

| | | |
|--|---|---|
|  | CAUTION RISK OF ELECTRIC SHOCK DO NOT OPEN |  |
| <p>CAUTION: TO REDUCE THE RISK OF ELECTRIC SHOCK, DO NOT REMOVE COVER (OR BACK). NO USER-SERVICEABLE PARTS INSIDE. REFER SERVICING TO QUALIFIED SERVICE PERSONNEL.</p> | | |

CAUTION:
TO PREVENT ELECTRIC SHOCK, MATCH WIDE BLADE OF PLUG TO WIDE SLOT, FULLY INSERT.

ATTENTION:
POUR ÉVITER LES CHOCS ÉLECTRIQUES, INTRODUIRE LA LAME LA PLUS LARGE DE LA FICHE DANS LA BORNE CORRESPONDANTE DE LA PRISE ET POUSSER JUSQU' AU FOND.



The lightning flash with arrowhead symbol, within an equilateral triangle, is intended to alert the user to the presence of uninsulated "dangerous voltage" within the product's enclosure that may be of sufficient magnitude to constitute a risk of electric shock to persons.



The exclamation point within an equilateral triangle is intended to alert the user to the presence of important operating and maintenance (servicing) instructions in the literature accompanying the appliance.

"WARNING"

"TO REDUCE THE RISK OF FIRE OR ELECTRIC SHOCK, DO NOT EXPOSE THIS APPLIANCE TO RAIN OR MOISTURE."

SAFETY INSTRUCTIONS

1. Read Instructions - All the safety and operating instructions should be read before the appliance is operated.
2. Retain Instructions - The safety and operating instructions should be retained for future reference.
3. Heed Warnings - All warnings on the appliance and in the operating instructions should be adhered to.
4. Follow Instructions - All operating and use instructions should be followed.
5. Water and Moisture - The appliance should not be used near water - for example, near a bathtub, washbowl, kitchen sink, laundry tub, in a wet basement, or near a swimming pool, and the like.
6. Carts and Stands - The appliance should be used only with a cart or stand that is recommended by the manufacturer.



An appliance and cart combination should be moved with care. Quick stops, excessive force, and uneven surfaces may cause the appliance and cart combination to overturn.

7. Wall or Ceiling Mounting - The appliance should be mounted to a wall or ceiling only as recommended by the manufacturer.
8. Ventilation - The appliance should be situated so that its location or position does not interfere with its proper ventilation. For example, the appliance should not be situated on a bed, sofa, rug, or similar surface that may block the ventilation openings; or, placed in a built-in installation, such as a bookcase or cabinet that may impede the flow of air through the ventilation openings.

9. Heat - The appliance should be situated away from heat sources such as radiators, heat registers, stoves, or other appliances (including amplifiers) that produce heat.
10. Power Sources - The appliance should be connected to a power supply only of the type described in the operating instructions or as marked on the appliance.
11. Grounding or Polarization - The precautions that should be taken so that the grounding or polarization means of an appliance is not defeated.
12. Power Cord Protection - Power supply cords should be routed so that they are not likely to be walked on or pinched by items placed upon or against them, paying particular attention to cords at plugs, convenience receptacles, and the point where they exit from the appliance.
13. Cleaning - The appliance should be cleaned only as recommended by the manufacturer.
14. Nonuse Periods - The power cord of the appliance should be unplugged from the outlet when left unused for a long period of time.
15. Object and Liquid Entry - Care should be taken so that objects do not fall and liquids are not spilled into the enclosure through openings.
16. Damage Requiring Service - The appliance should be serviced by qualified service personnel when:
 - A. The power supply cord or the plug has been damaged; or
 - B. Objects have fallen, or liquid has been spilled into the appliance; or
 - C. The appliance has been exposed to rain; or
 - D. The appliance does not appear to operate normally or exhibits a marked change in performance; or
 - E. The appliance has been dropped, or the enclosure damaged.
17. Servicing - The user should not attempt to service the appliance beyond that described in the operating instructions. All other servicing should be referred to qualified service personnel.

Table of Contents

| | |
|---|-----------|
| Introduction..... | 6 |
| Precautions..... | 6 |
| Notes about power supply..... | 6 |
| Notes on handling the hard disk..... | 7 |
| Notes on the setup location..... | 7 |
| Notes on repair..... | 8 |
| About copyrights..... | 8 |
| About damages..... | 8 |
| Notes on using the Detachable Controller..... | 8 |
| How to use a dust cap (included)..... | 8 |
| Main Features of D-160..... | 9 |
| Names and Functions..... | 12 |
| Front panel..... | 13 |
| Detachable controller..... | 14 |
| Rear panel..... | 23 |
| Display section..... | 25 |
| 1. Display shown when the power is turned on..... | 25 |
| 2. Preset display..... | 25 |
| 3. Switching the display using the DISP SEL key..... | 26 |
| 4. Switching the Time Base display using the EXECUTE/YES key and DISP SEL key..... | 27 |
| 5. Changing Programs using the STORE key and the HOLD/> key..... | 28 |
| 6. Warning messages..... | 29 |
| Before operating the D-160..... | 32 |
| 1. Hard disk recording method and the REMAIN display..... | 32 |
| 2. Audio file and Event..... | 33 |
| 3. Program Change function..... | 35 |
| 4. Real track and Additional track..... | 36 |
| 5. Input monitor and Repro monitor..... | 37 |
| 6. Time Base..... | 38 |
| 7. Installing and formatting a hard disk..... | 39 |
| Installing a removable hard disk cartridge..... | 40 |
| Replacing a removable hard disk cartridge..... | 41 |
| Installing a hard disk in removable case Model 9040B..... | 42 |
| Formatting a hard disk..... | 43 |
| 8. Extending the detachable controller..... | 44 |
| Recording/Playback..... | 46 |
| 1. Basic connections..... | 46 |
| 2. The default setting on the D-160..... | 48 |
| 2-1. Setting a Program..... | 49 |
| 2-2. Program Change..... | 50 |
| 2-3. Deleting a Program..... | 51 |
| 2-4. Setting a Sampling Rate..... | 52 |
| 3. Analog Recording and Playback..... | 53 |

| | |
|---|------------|
| 3-1. Basic recording and playback..... | 53 |
| 3-2. Recording with the Program Change function..... | 54 |
| 3-3. Playback using the Vari-pitch function..... | 56 |
| 3-4. Multitrack recording using overdubbing..... | 57 |
| 3-5. Mixdown..... | 58 |
| 3-6. Ping-pong recording..... | 59 |
| 4. Digital Recording..... | 60 |
| 4-1. Digital recording from an external digital device (S/P DIF)..... | 60 |
| 4-2. Digital recording to an external digital device | 63 |
| 4-3. Connecting a digital mixer..... | 65 |
| Locate function..... | 67 |
| 1. Storing memory data..... | 67 |
| 2. Locate..... | 69 |
| 3. Auto Play mode..... | 70 |
| 4. Auto Return mode..... | 70 |
| 4-1. Setting the Auto Return Start/End point..... | 71 |
| 5. Auto Repeat mode..... | 74 |
| Punch In/Out..... | 75 |
| 1. Auto Punch In/Out..... | 76 |
| 1-1. Storing the Punch In/Out point..... | 76 |
| 1-2. Auto Punch In/Out Rehearsal mode..... | 78 |
| 1-3. Auto Punch In/Out Take mode..... | 79 |
| 1-4. Undo/Redo of Auto Punch In..... | 80 |
| 2. Punch In/Out recording using a foot switch..... | 81 |
| 2-1. Punch In/Out Rehearsal..... | 82 |
| 2-2. Punch In/Out Take..... | 83 |
| 2-3. Undo/Redo of Manual Punch In/Out..... | 84 |
| Edit function..... | 85 |
| 1. Copy & Paste..... | 86 |
| 1-1. Copying..... | 86 |
| 1-2. Copy & Pasting..... | 88 |
| 1-3. Copy & Paste Undo/Redo..... | 90 |
| 2. Move & Paste..... | 91 |
| 2-1. Moving..... | 91 |
| 2-2. Move & Pasting..... | 93 |
| 2-3. Move & Paste Undo/Redo..... | 95 |
| 3. Erase..... | 96 |
| 3-1. How to Erase data for a specific part between ABS 0 and ABS END..... | 97 |
| 3-2. Undo and Redo of the erase operation..... | 98 |
| 3-3. How to Erase data in its entirety from a specified point up to ABS END..... | 99 |
| 3-4. Undo and Redo of the erase operation..... | 100 |
| 3-5. Erasing specific data..... | 101 |
| Saving/Loading Song Data..... | 102 |
| 1. Saving the data using DATA OUT..... | 104 |
| 2. Loading the data using DATA IN | 106 |
| 3. Saving the data using SCSI..... | 108 |

| | |
|---|------------|
| 4. Compatibility with D-90, D-80 (V2.0),DMT-8 (V2.0), and DMT-8VL..... | 116 |
| MIDI sync function..... | 117 |
| 1. MIDI clock sync system..... | 117 |
| 2. MTC sync/MIDI machine control system..... | 120 |
| 3. Multitrack system by the slave mode..... | 123 |
| 4. External MIDI equipment sync system by the slave mode..... | 127 |
| 5. Sync system with "adat" by the slave mode..... | 130 |
| 6. Multitrack system using a D-90/D-80 (Ver.2) /DMT-8 (Ver.2/VL)..... | 133 |
| Setup mode..... | 137 |
| 1. How to enter the Setup Mode..... | 137 |
| 2. How to set each mode..... | 142 |
| 2-1. Track Swapping ("Track Exchange?")..... | 142 |
| 2-2. Time Signature Setting (Signature Set?)..... | 143 |
| 2-3. Tempo Setting ("Tempo Map Set?")..... | 145 |
| 2-4. Program Title setting ("TitleEdit PGM?")..... | 147 |
| 2-5. Program Delete ("Delete PGM?")..... | 147 |
| 2-6. Metronome Setting ("Click ♩?")..... | 148 |
| 2-7. Preroll Time Setting ("Preroll Time?")..... | 149 |
| 2-8. MIDI Sync Signal Out Setting (Midi Sync Out?)..... | 150 |
| 2-9. MTC Frame Rate Setting ("Frame Rate?")..... | 151 |
| 2-10. MTC Offset Time Setting ("MTC Offset?")..... | 152 |
| 2-11. MTC Offset Mode Setting ("MTC Offset?")..... | 153 |
| 2-12. Slave Mode Setting ("Slave Mode?")..... | 154 |
| 2-13. Slave Mode Type Setting ("Slave Type?")..... | 155 |
| 2-14. Record Protect Setting ("Rec Protect?")..... | 156 |
| 2-15. Digital Input Track Setting ("Digi. In?")..... | 157 |
| 2-16. Digital Output Track Setting ("Digi. Out?")..... | 159 |
| 2-17. Bar/Beat Resolution Mode Setting (" ♩ Resolution?")..... | 160 |
| 2-18. MIDI Device ID Setting ("Device ID?")..... | 161 |
| 2-19. Sampling Frequency Setting ("Sample Rate?")..... | 162 |
| 2-20. Event Number Check on Each Track ("NOs Of Event?")..... | 163 |
| 2-21. Current Drive Setting ("Drive Sel.?)..... | 164 |
| 2-22. Loading Song Data ("Load PGM?")..... | 165 |
| 2-23. Saving Song Data ("Save PGM?")..... | 168 |
| 2-24. Formatting IDE/SCSI disk ("Disk Format?")..... | 171 |
| MIDI Implementation Chart..... | 172 |
| MMC command list..... | 173 |
| Inquiry Message list..... | 173 |
| Fostex MIDI System Exclusive Message Format..... | 174 |
| Maintenance..... | 189 |
| Specifications..... | 189 |

Introduction

Thank you for purchasing the Fostex Model D-160.

The D-160 is a 16-track digital multitrack recorder with eight additional tracks that employs a 3.5-inch E-IDE type removable hard disk as the recording media, instead of conventional tape. An optional Model 9041 (1.3GB removable hard disk cartridge), is available for 16-track (plus additional tracks) recording and playback.

A total of 240 minutes recording/playback time is available based on a single track calculation.

The D-160 achieves high-quality recording/playback with 16-bit linear quantization and a non-compression recording technique with two "Adat I/O" (switchable for S/P DIF), which enables 16-track simultaneous recording (8 analog, 8 digital/16 digital) as well as 8-track simultaneous recording and 16-track simultaneous playback.

You can easily configure a fully digital recording system by combining the D-160 with various types of digital mixing consoles. You can back up recordings from the hard disk to an Adat machine, or to a DAT machine.

Also, high speed backup is available via a standard SCSI terminal.

The D-160 features a +/-6% Vari-pitch function, and various non-destructive edit functions, such as copy, move & paste, erase, etc., that use three Time Bases.

Furthermore, it facilitates a complete MIDI environment by supporting MTC and MMC, output of MIDI clock and Song Position Pointer via an internal Tempo Map, and advanced controls by FEX.

It also has a Program Change function to manage up to 99 Programs, and you can assign a title to each song (Program).

Installing an optional 8345 TC/SYNC card enables the D-160 to support slave operation for the incoming LTC, and synchronization with video reference signals and Word Clock, as well as to output Word Clock signal to an external digital device. Installing an optional 5041 balanced 8-16 I/O card would add +4dBu analog, balanced I/Os.

Please read this User's Guide thoroughly and keep it in a safe place so that you will be able to produce high-definition, high tonal quality music and make the best use of the D-160 for a long time.

Precautions

Notes about power supply

- * Be sure to connect the D-160 to the power supply specified in the Specifications section of this Owner's Manual. Do not use an AC outlet of any other voltage.
- * Do not connect the D-160 to the same AC outlet to which devices that could generate noise (such as a large motor or dimmer), or devices that consume a large amount of power such as an air conditioning system or a large electric heater are connected.
- * If you use the unit in an area with a different power voltage, first consult your dealer or the nearest FOSTEX service station. You can use the unit with a power frequency of 50Hz or 60Hz.
- * It is very dangerous to use a power cord that is frayed or damaged. In such a case, stop using the unit immediately and ask your dealer to repair the cord.
- * To avoid possible electric shock and damage to the D-160, avoid contact with water or other liquids. Do not handle the power plug while your hands are wet.

- * To prevent possible electric shock and damage to the D-160, do not remove the main unit cover or reach the inside the unit.
- * Do not let water or other liquids, or metal objects such as pins, accidentally get into the D-160 because this may lead to electric shock or damage. Should water enter the inside of the unit, remove the power plug from the AC outlet, and consult your dealer or nearest FOSTEX service station.
- * To prevent damage to the D-160, be sure to turn on any connected devices first, and then turn on the power to the D-160. When you removing or connecting the cables to the input/output connectors on the D-160, make sure that the channel INPUT faders and volume controls are set to "0."

Notes on handling the hard disk

- * "FORMAT FIRST".
You need to format the optional hard disk prior to start recording if a brand new hard disk drive has been installed.
Refer to the explanation of "2-24. Disk Format ?" menu on the Setup mode.
We recommend that you better the hard disk before you start fresh recording on it.
However, be also aware of that the formatting process will erase all the recorded song data.
- * The D-160 is equipped with a high-precision hard disk. Do not expose the unit to excessive vibration at any time. In particular, do not move the unit or allow any impact to the unit when the power is on.
- * **Before turning the power off to the D-160, first quit Setup mode and make sure that the recorder section is stopped. Especially, never attempt to turn off the power to the unit while the hard disk is accessing data (the HD ACCESS LED is lit or flashing). Otherwise, not only will you lose recorded data, but you may damage the D-160. FOSTEX is not responsible for data lost during operation of the D-160.**
- * Pack the D-160 in its shipping carton or an impact-resistant case, if you plan to relocate it.
Make sure that the D-160 is kept free from external vibration or impact since the it is very sensitive to vibration.

* If you wish to replace the included removable hard disk with another hard disk, refer to "Before operating the D-160" on page "39."

Notes on the setup location

- * Do not install the D-160 in locations subject to the following:
 - * Extremely high or low temperature, or significant changes in temperature
 - * Excessive humidity or dust
 - * Excessive changes in power supply voltage
 - * Unstable or significantly vibrating or shaking surfaces
 - * Close to strong magnetic fields (such as a TV or speakers)
- * If you move the D-160 from a place with an excessively low temperature to a warm place, or if you use the D-160 in a room in where the temperature varies significantly during winter, condensation may occur on the hard disk or other parts.
In such cases, leave the D-160 in its new location for about an hour before you turn on the power.

Notes on repair

- * The D-160 does not use any parts that users can repair easily. Contact your dealer or the nearest FOSTEX service station to ask about repairs.
- * Do not throw the original carton box and packing material away. You should use them when transporting the D-160. The warranty will not cover damage due to improper packaging. Also, Fostex is not responsible for damage occurring during transit.

About copyrights

- * It is prohibited by law to use any part of a CD recording or video images or audio data for which a copyright is possessed by a third party for commercial purposes such as contents, broadcasts, sales, or distribution - any purpose other than for your personal pleasure.

About damages

- * Fostex is not responsible for any "direct damage" or "indirect damage" caused by using the D-160.

Notes on using the Detachable Controller

- * When you use the detachable controller remotely using an extension cable, the D-160 may malfunction due to electromagnetic interference. In this case, turn the power off, and then on to the D-160 to restore the normal condition. Fostex is not responsible for any malfunction of the D-160 caused by electromagnetic interference.

How to use a dust cap (included)

- * Plug the included dust cap onto the connector of the D-160's removable hard disk to protect the disk from static electricity, dust and dirt before you store or transport the hard disk.

<WARNING>

A hard disk is precision device. Handle it with care and avoid vibration, humidity, strong magnetic fields, static electricity, dust, etc. In particular, do not touch the connector with your hands to protect the hard disk from static electricity.

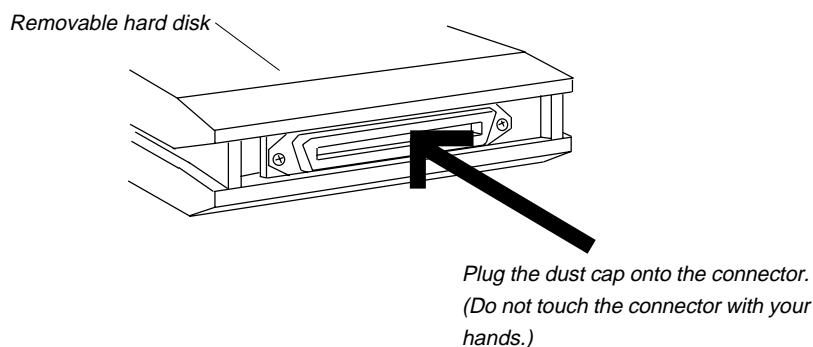

Main Features of D-160

The D-160 is equipped with the following functions:

- * *Employs a 3.5 inch E-IDE type removable hard disk system. With an optional 9041 (1.3GB removable hard disk cartridge), 16-track (plus additional 8 tracks) recording and playback. Total 240 minutes recording/playback time based on a single track calculation.*
- * *Non-compression recording/16 bit linear quantization and sampling rates of 44.1kHz and 48kHz (assignable for each Program and each playback), achieving true CD quality. "Adat optical I/O" (switchable to S/P DIF), enables 16-track simultaneous recording (8 analog, 8 digital). Connecting adat output (x2) of a digital console and adat optical inputs (x2) of the D-160 allows for 16-track simultaneous digital recording.*
- * *Employs a new disk management method, "FDMS-3" (Fostex Disk Management System-3). With this method, only the recorded part consumes the disk space, which allows highly efficient multitrack recording.*
- * *Program Change function for managing up to 99 Programs (each Program title editable). Non-volatile locate memory for each Program, with a pre-roll time of 0 - 10 seconds.*
- * *Bar/beat Resolution function for storing memory in Bar/Beat units.*
- * *Significantly improved efficiency with an FL display that features a high-visibility 16-character indication.*
- * *Erase Program function and Delete Program function, convenient for efficient song management.*
- * *MIDI IN/OUT/THRU terminals support the output of MIDI clock and Song Position Pointers via an internal Tempo Map, as well as support MTC/MMC. They also support advanced recorder control via FEX (Fostex System Exclusive) for advanced functions. These terminals, along with the functions to store the MTC output offset by Bar/Beat, to store 24-hour MTC offset, and to display external MTC (or LTC), will facilitate configuring an integrated MIDI environment.*

- * *A programmable internal Tempo Map, with a selection of eleven time signatures and a quarter note range of 30 to 250, and Metronome function.*
- * *REC Protect function to prevent accidental recording*
- * *Number Of Events Monitor function that monitors the overflow of events.
The number of created events can be displayed for each track.*
- * *Installing an optional 8345 TC/SYNC card allows for the MTC-to-LTC conversion and output, as well as the slave operation for incoming LTC.
It also allows for synchronization with video reference signals and Word Clock, as well as output of Word Clock signal to an external digital device.*
- * *Selectable reference time code (MTC/LTC), with six frame rates (24/25/30ND/30DF/29.97ND/29.97DF).*
- * *Wide selection of slave types (Vari, S/P DIF, adat, Free), 8345 clock (INT/VIDEO/WORD/AUTO), and WORD out (8345/D-160) to support various sync environment. Eight Sync Presets available to recall complex sync settings at once.*
- * *The optional 5041 will add eight +4dBu, analog balanced inputs (D-SUB25 pin x 1) and 16 outputs (D-SUB25 pin x 2) to the D-160's -10dBV unbalanced I/Os (RCA pin).*
- * *Adat backup as well as conventional DAT backup supported.
Equipped with a standard SCSI interface, which allows for a high-speed data backup to an external SCSI device.
Also, a Save Length Setting function enables backup of the specified part of a Song.*
- * *+/-6% Vari-pitch function for fine pitch adjustment without significant tonal quality deterioration.*
- * *Sixteen standard tracks, plus eight additional tracks (Tr. 17-24).*
- * *Track Exchange function for swapping any tracks 1-24.
Track exchange of eight tracks (1-8, 9-16, 17-24) is also available.*
- * *Detachable controller, which can be extended up to 10 meters with two optional 8551 extension cables (5m).*

- * *High-speed edit functions, typical for a hard disk, such as non-destructive copy & paste, move & paste, erase, and undo/redo. You can also specify the number of repeated operations (up to 99 times).*
- * *Three Time Base (ABS, MTC, Bar/Beat), REMAIN indication based on each Time Base, and indication of remaining hard disk space.*
- * *Auto Punch In/Out with rehearsal, Auto RTN/Play, Locate ABS 0, and Locate ABS END function for checking the recording end point.*
- * *Digital scrubbing with the JOG dial, and audio cue with the SHUTTLE dial.*

FRONT PANEL (with the detachable remote controller)

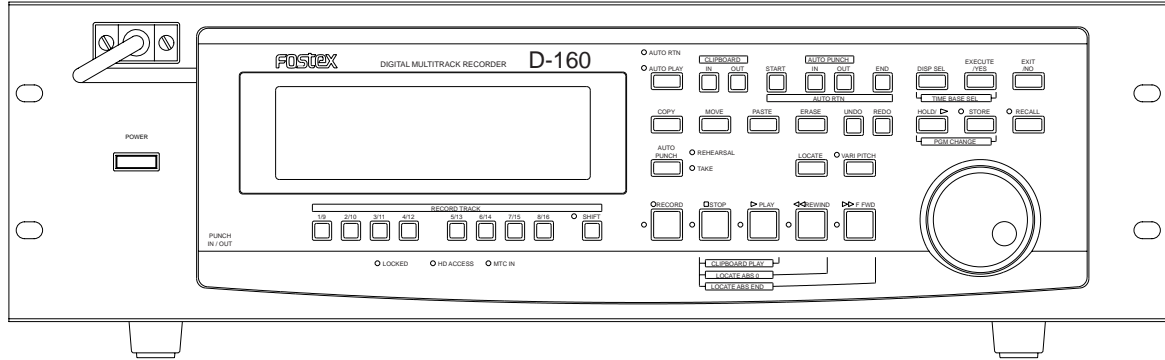

FRONT PANEL (with the detachable controller removed)

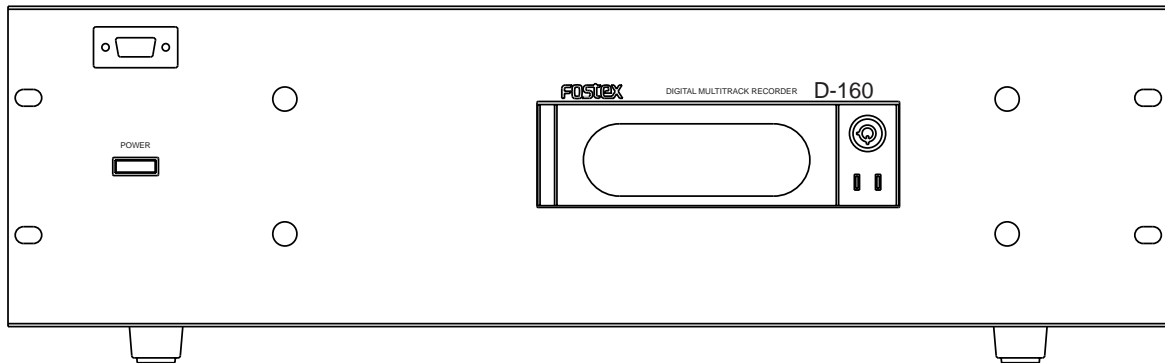

REAR PANEL

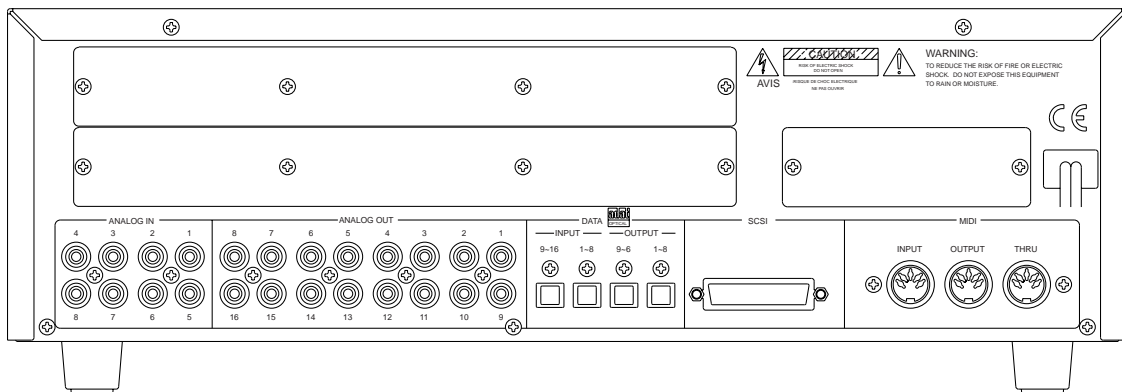

Names and Functions

<Front Panel (with the detachable controller removed)>

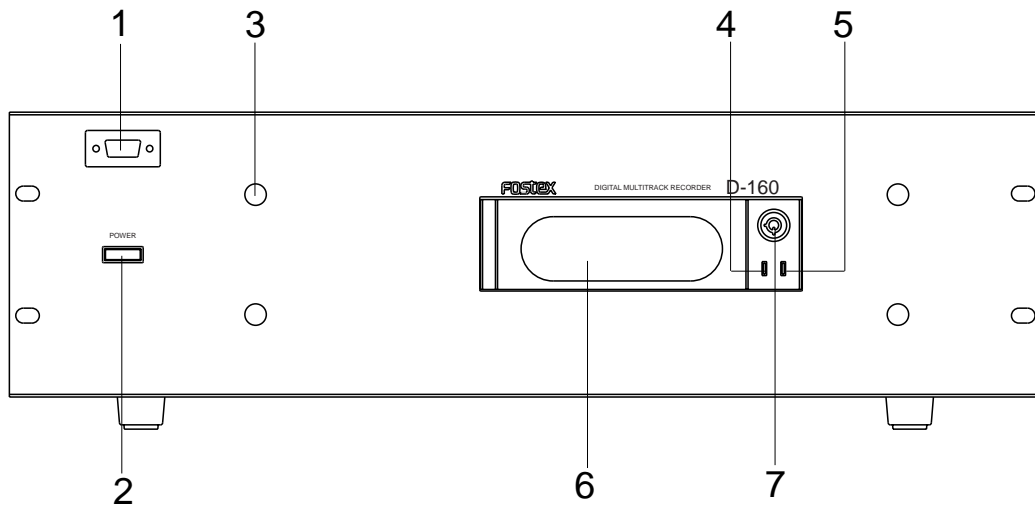

1. Detachable remote controller connector

The detachable remote controller is connected here.

You can remove the controller. Connect the optional extension cable (Model 8551) to extend the distance.

* Refer to page "44" for information on extending the detachable remote controller connection.

2. Power switch

This switch turns the main power to the D-160 on/off.

<WARNING !>

Before turning the power off to the D-160, first quit the Setup mode and make sure that the recorder section is stopped. Especially, never attempt to turn off the power to the unit while the hard disk is accessing data (the HD ACCESS LED is lit or flashing). Otherwise, not only will you lose recorded data, you may damage to the unit.

3. Controller mount

The detachable remote controller is mounted on the front panel.

4. Hard disk access LED

This LED lights up or blinks when the hard disk is writing or reading data. (Same as the HD ACCESS LED on the detachable remote controller.)

5. Hard disk power LED

This LED lights up if the hard disk operates correctly when you turn the power on to the unit. If the Lock key is unlocked, the power to the hard disk will not be turned on, and the LED will not light up.

6. Removable hard disk cartridge slot

This slot is used to insert a removable hard disk cartridge. This system allows you to replace the hard disk easily.

* Refer to page "41" for more information on how to replace the removable hard disk cartridge.

<Note>

This slot is covered by a dust-proof panel when the unit is shipped from the factory. Remove this panel in order to insert a cartridge.

<Note>

The D-160 package contains a removable case (without a hard disk). Install your hard disk in this removable case.
 The optional Model 9041 (1.3GB removable hard disk cartridge) contains a hard disk, which allows you to record and play back about 15 minutes of data (16-tracks recording, FS: 44.1 kHz) without having to install a case.

* Refer to page "39" for more information on the hard disk models that have already been tested for operation on the D-160.

7. Lock/Unlock key

When you remove or install the hard disk cartridge, you need to lock/unlock here using the included key.

<Note>

Be sure to turn the power off to the D-160 before locking or unlocking.

<Detachable Controller>

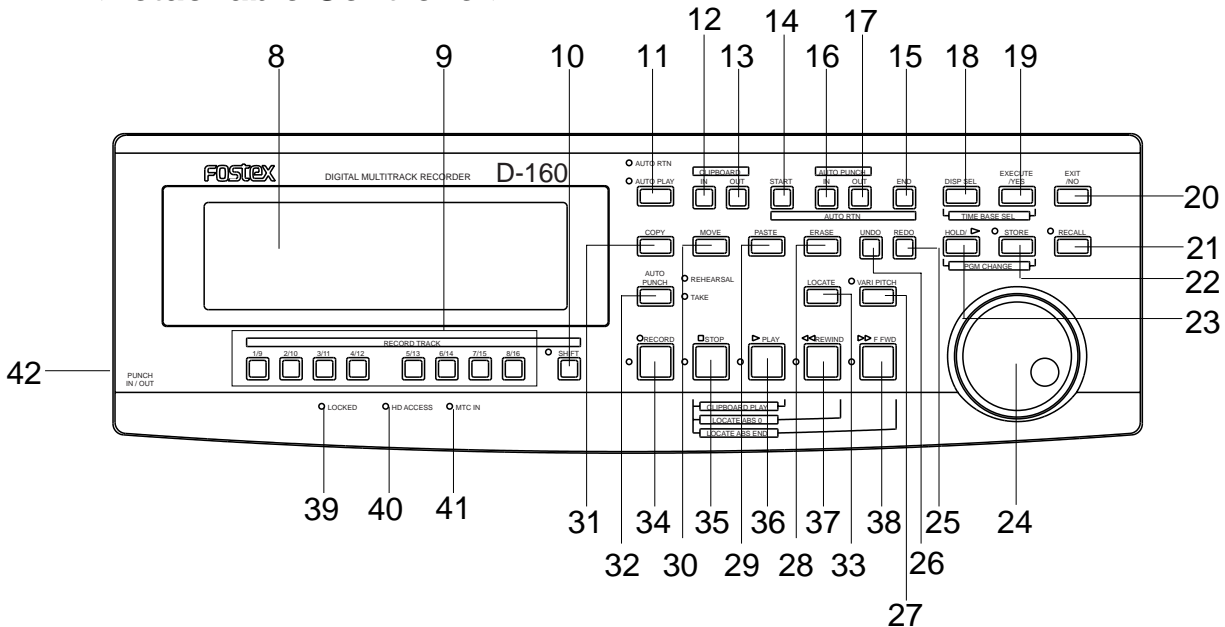

8. Meter display

This meter display shows the signal level and settings.

* Refer to the "Display section" on page "25."

9. Record Track Select key [RECORD TRACK]

The Record Track Select key selects "SAFE-READY" for the recording track. When you press this key once, the track enters the READY status, and the track indication on the display will blink. Pressing it again changes this status to "SAFE" and the track indication will go out. When you start recording, the blinking track indication illuminates.

When you press only the RECORD button while the track is in the READY status, the track becomes an input monitor, allowing you to adjust the recording level. Pressing only the RECORD button again, and the track become a reproduction monitor. This key is also used to select a track for the Copy & Paste, Move & Paste, Erase, or other editing operation.

* Refer to page "37" for details about the reproduction monitor and the input monitor.

10. Shift key [SHIFT]

Use this key to choose recording tracks.

When the shift LED lights off, it allows you to choose track 1~8.

When the LED is on, tracks 9~16 can be chosen.

11. Auto Play/Auto Return key

Pressing this key repeatedly will change Auto Play mode, Auto Return mode, and Repeat mode On/Off as follows: (○ : LED off, ● : LED light up)

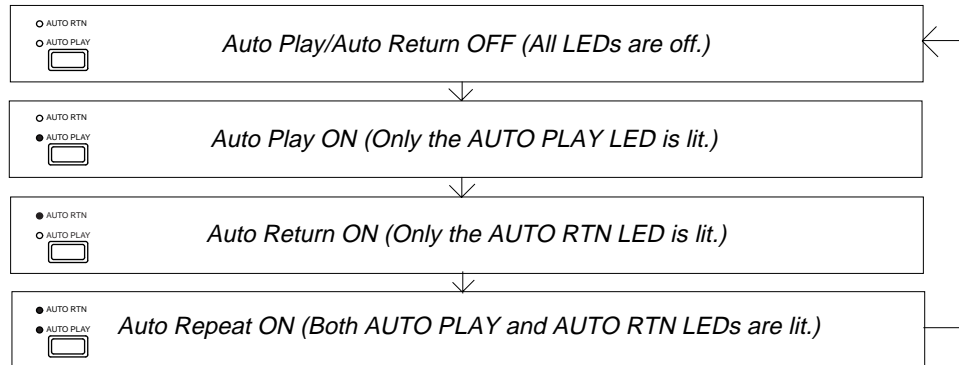

Auto Play mode:

In this mode, playback will start automatically after the START point is located. This function is effective at any locate points other than the ABS END point.

Auto Return mode:

When the END point is reached during playback, the START point is automatically located in this mode. This function is effective only when the START and END points have been specified.

<Note>

The Auto Return function works only during playback. In the recording mode, the START point will not be located automatically when the END point is reached.

Auto Repeat mode:

This mode is a combination of Auto Play and Auto Return, and plays back the part between the START and END points repeatedly. The auto repeat function is effective only when the START and END points have been specified correctly.

* Refer to page "67" for details.

12. Clipboard In key [CLIPBOARD IN]

This key is used to store and recall the In point (CLIPBOARD IN point) for the Copy or Move operation. You can locate a stored CLIPBOARD IN point.

* Refer to page "85" for copying/moving data.

* Refer to page "67" for locating the CLIPBOARD IN point.

13. Clipboard Out key [CLIPBOARD OUT]

This key is used to store and recall the Out point (CLIPBOARD OUT point) for the Copy or Move operation. You can locate a stored CLIPBOARD OUT point.

* Refer to page "67" for locating the CLIPBOARD OUT point.

* Refer to page "85" for copying/moving data.

14. Auto Return Start key [AUTO RTN START]

This key is used to store and recall the start point (AUTO RTN START point) for the Auto Return or Auto Repeat operation.

You can locate a stored AUTO RTN START point.

* Refer to page "69" for more information about Auto Return and Auto Repeat.

15. Auto Return End key [AUTO RTN END]

This key is used to store and recall the end point (AUTO RTN END point) for the Auto Return or Auto Repeat operation.

You can locate a stored AUTO RTN END point.

* Refer to page "69" for more information about Auto Return and Auto Repeat.

16. Auto Punch In key [AUTO PUNCH IN]

This key is used to store and recall the recording start point (AUTO PUNCH IN point) for the Auto Punch IN/OUT operation. This point is also used as an erase point.

You can locate a stored AUTO PUNCH OUT point.

* Refer to page "75" for more information about Auto Punch In/Out recording.

* Refer to page "85" for more information about pasting data.

* Refer to page "96" for more information about the Erase operations.

17. Auto Punch Out key [AUTO PUNCH OUT]

This key is used to store and recall the recording end point (AUTO PUNCH OUT point) for the Auto Punch IN/OUT operation. This point is also used as an erase point.

You can locate a stored AUTO PUNCH OUT point.

* Refer to page "75" for more information about Auto Punch In/Out recording.

* Refer to page "96" for more information about the Erase operation.

Memory keys (CLIPBOARD IN, CLIPBOARD OUT, AUTO RTN START, AUTO PUNCH IN, AUTO PUNCH OUT, and AUTO RTN END keys) have the following common functions:

- * Pressing a Memory key to recall the point the key is storing (or pressing the RECALL key, and then the Memory key) displays the memory data (time, or bar/beat/clock) currently stored in that key; then the unit enters data edit mode. To edit data, use the HOLD/> key or the SHUTTLE dial to move among the digits, and then use the JOG dial to change the value.
- * After you finish editing data, press the STORE key, and then press one of the Memory keys into which you want to store the point. The edited data will be stored in the specified Memory key.
- * While the current position of the recorder is indicated, press the STORE key, then one of the Memory keys into which you want to store the data. The current position or the recorder will be stored in the Memory key. You can do this while the recorder is running or stopped.
- * Press a desired Memory key, and then press the LOCATE key to locate the point stored in that Memory key (time, or bar/beat/clock).
- * All memory data can be stored to Programs 1-99 individually.
- * In Setup mode, you can save or load song data for each Program.
- * All data will be retained after you turn off the power.

* Refer to page "67" for more information on memory data.

* Refer to page "67" for more information on the Locate function.

* Refer to pages "28" and "49" for more information on the Program Change function.

* Refer to page "102" for more information on saving and loading song data.

18. Display Select key [DISP SEL]

This key is used to change the display mode. Pressing this key repeatedly will change the display mode as follows:

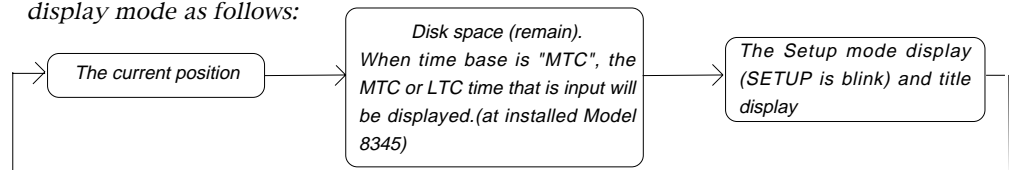

* Refer to pages "26" and "32" for more information about the REMAIN.

Pressing this key while holding down the EXECUTE/YES key will switch the Time Base (*) as follows. The Time Base can be set when the display shows the recorder's current position or the available disk space (REMAIN).



(*) Time Base:

The D-160 uses time display (ABS or MTC) or Bar/Beat/Clock display to indicate the current position of the recorder section. These displays are called "Time Base." ABS (Absolute Time) shows the absolute time of the disk, and MTC (MIDI Timecode) shows the relative time obtained by adding an MTC offset value to the ABS value. Bar/Beat/Clock (BAR/BEAT/CLK) indicates a position within a piece of music and conforms to the MIDI clock and Song Position Pointers created on the internal Tempo Map. The tune will be displayed up to 999 bars.

* Refer to pages "38" and "145" for more information about MTC and the internal Tempo Map.

19. Execute/Yes key [EXECUTE/YES]

Press this key to execute the operation when you edit data on the hard disk using the edit functions such as Paste and Erase, when you put the D-160 into SETUP mode, or when you set the parameters in the SETUP menu.

Pressing the DISP SEL key while holding down the EXECUTE/YES key allows you to select the Time Base. (Refer to the explanation about the DISP SEL key.)

* Refer to page "85" for more information about using this key for the Paste or Erase operation.
* Refer to page "137" for more information about using this key in SETUP mode.

20. Exit key/No key [EXIT/NO]

The opposite of the EXECUTE/YES key, this key is used to stop the operation.

* Refer to page "85" for more information about using this key for the Paste or Erase operation.
* Refer to page "137" for more information about using this key in SETUP mode.

21. Recall key [RECALL]

Press this key to recall the stored time value (or Bar/Beat/Clock value).

Pressing this key, and then one of the following keys will display the data stored at the key you pressed, and you will be able to edit the data.

| | |
|----------------------------------|---|
| RECALL key -> CLIPBOARD IN key | The Clipboard In point is recalled and the D-160 enters the edit mode. |
| RECALL key -> CLIPBOARD OUT key | The Clipboard Out point is recalled and the D-160 enters the edit mode. |
| RECALL key -> AUTO PUNCH IN key | The Auto Punch In point is recalled and the D-160 enters the edit mode. |
| RECALL key -> AUTO PUNCH OUT key | The Auto Punch Out point is recalled and the D-160 enters the edit mode. |
| RECALL key -> AUTO RTN START key | The Auto Return Start point is recalled and the D-160 enters the edit mode. |
| RECALL key -> AUTO RTN END key | The Auto Return End point is recalled and the D-160 enters the edit mode. |
| RECALL key -> LOCATE key | The Locate key data is recalled and the D-160 enters the edit mode. |

To exit edit mode, press the EXIT/NO key, DISP SEL key, or STOP button.

* Refer to page "85" for more information about the clipboard.
 * Refer to page "75" for more information about Auto Punch In/Out recording.
 * Refer to page "70" for more information about Auto Return.

22. Store key [STORE]

This key is used to store a time value (or Bar/Beat/Clock value) to one of the memory keys. Pressing this key, and then one of the following keys will cause the data shown on the display to be stored to the corresponding memory key you pressed. Pressing the STORE key while holding down the HOLD/> key will change a Program.

| | |
|---------------------------------|--|
| STORE key -> CLIPBOARD IN key | Data is stored as a Clipboard In point. The stored data can be used as a locator. |
| STORE key -> CLIPBOARD OUT key | Data is stored as a Clipboard Out point. The stored data can be used as a locator. |
| STORE key -> AUTO PUNCH IN key | Data is stored as an Auto Punch In point. The stored data can be used as a locator. |
| STORE key -> AUTO PUNCH OUT key | Data is stored as an Auto Punch Out point. The stored data can be used as a locator. |
| STORE key -> AUTO RTN START key | Data is stored as an Auto Return Start point. The stored data can be used as a locator. |
| STORE key -> AUTO RTN END key | Data is stored as an Auto Return End point. The stored data can be used as a locator. |
| STORE key -> LOCATE key | Data is stored as a LOCATE key data. |

After pressing this key, if you wish to cancel the store operation, press the EXIT/NO key, DISP SEL key, or STOP button.

* Refer to page "85" for more information about the clipboard.
 * Refer to page "28" and "49" for more information about Program Change function.
 * Refer to page "67" for more information about the Locate function.
 * Refer to page "75" for more information about Auto Punch In/Out recording.
 * Refer to page "70" for more information about Auto Return.

23. Hold/Digit Move key [HOLD/>]

Pressing this key while the recorder transport is operating will hold the time value (or Bar/Beat/Clock value), display the value on the screen, and will place the D-160 into edit mode. If you press this key while the recorder section is stopped, the D-160 will enter edit mode. Pressing this key repeatedly allows you to select the digit (column) to edit. To cancel edit mode, press the STOP button, DISP SEL key, or EXIT/NO key. Pressing the STORE key while holding down the HOLD/> key will change the Program.

* Refer to pages "67" and "85" for more information about using this key.

24. Jog/Shuttle dial

Jog dial (inside):

Turning the JOG dial while the recorder is stopped performs digital scrubbing in either direction, which allows you to check the audio and locate a point without any change in pitch.

The JOG dial is also used to change values in the data edit mode or when the pitch data is displayed. It also allows you to select a parameter to set in Setup mode.

Shuttle dial (outside):

FWD and REW direction shuttle operation in the STOP mode is possible at +/-1 ~ 64 times fast winding in the no sound state. On the other hand, FWD and REW direction shuttle operation in the PLAY mode is possible in the CUE playback mode at +1 ~ 8 and -1 ~ -7 times speed while cueing. In addition, while in the display edit mode, the editing point can be moved in the same way as by the HOLD/> key.

* Refer to pages "67" and "85" for more information about the editing the memory data.
 * Refer to page "137" for more information about Setup mode.

25. Redo key [REDO]

Pressing this key after you press the UNDO key restores the status obtained before you undo recording or editing. This key is activated only when the recorder transport section is stopped.

* Refer to pages "75" and "85" for more information about the Redo operation.

26. Undo key [UNDO]

After using an edit function such as Paste, or Erase, or after auto punch in/out recording, pressing this key will restore the previous status before editing or recording. This key is activated only when the recorder transport section is stopped.

* Refer to pages "75" and "85" for more information about the Undo operation.

27. Erase key [ERASE]

This key is used to erase a specified area or all data after a specified point on certain "READY" track(s), or all the data in a specified Program.

Use the Auto Punch In/Out points and the RECORD TRACK select key to specify the area to erase.

To erase all data in a Program, press the STORE key while holding down the HOLD/> key to select the Program, then press the ERASE key.

All data recorded in the Program will be erased. You do not need to set a track in READY mode.

* Refer to page "96" for more information about the Erase operation.

28. Vari-pitch key [VARI PITCH]

Use this key to turn the Vari-pitch function on and off. When this function is enabled, the corresponding LED lights up. When this function is disabled, the LED turns off.

The range of pitch variation for playback and recording is +/-6.0%, in 0.1% steps.

Press the RECALL key, and then the VARI PITCH key to display the current pitch data.

To change the pitch data, use the JOG dial to change the value while the pitch data is displayed.

You can also change the playback speed when the data is being played back with the Vari-pitch function ON.

* To quit the pitch data display, press the EXECUTE/YES key, the EXIT/NO key, or the STOP button.

<Note>

Even when the vari-pitch data is set to 0.0%, pressing this key will turn the LED on.

<Note>

You cannot change the pitch data while recording. If the Vari-pitch function was on, the unit will use the pitch data previously set.

<Note>

The Vari-pitch function will be automatically turned off in the following situations:

- * When you turn on the power to the unit (The pitch data will be reset to 0.0%.)
- * When you set Slave mode ON. (The pitch data remembers the previous setting.)
- * When you set up the digital input tracks and "DIGITAL" appears on the display. (The pitch data remembers the previous setting.)

If you have installed an optional Model 8345 TC/SYNC card in the D-160 and you have set the "Word Out?" menu in the Setup mode to "8345," the Vari-pitch function turns on even during digital input via DIGITAL IN.

* Refer to page "56" for more information on the Vari-pitch function.

* Refer to page "123" for more information on Slave mode.

* Refer to page "60" for more information on digital signals.

29. Paste key [PASTE]

Press this key to copy data or move data that has been copied to the clipboard to a location stored at the AUTO PUNCH IN key. The data will be pasted at the point stored in the Auto Punch In key. You can select the paste destination track using the RECORD TRACK select key. A destination track to which data is pasted is identical to the source track. This key is activated only when the recorder transport section is stopped.

* Refer to page "85" for more information about the Copy & Paste, and Move & Paste operation.

30. Move key [MOVE]

This key is used to enter into the clipboard data stored in memory by the CLIPBOARD IN/OUT keys. Pressing the MOVE key will store the data in the Clipboard as Move data. To enter data to be moved, one or more tracks must be readied, and a correct value must be stored for the In and Out points. If you attempt to enter data when all tracks are safe, all track indications and "Select Track!" indication on the display will blink to warn you. If a correct value is not set for the Clipboard In or Out points, a warning message of "Void In Point!" or "Void Out Point!" will appear.

* Refer to page "85" for more information about the Copy & Paste, and Move & Paste operation.

31. Copy key [COPY]

This key is used to copy data stored in the memory using the CLIPBOARD IN/OUT keys. Pressing the COPY key will store the data in the Clipboard as Copy data. To execute the copy operation, one or more tracks must be readied, and a correct value must be stored for the In and Out points. If you attempt to copy data when all tracks are safe, all track indications and a "Select Track!" indication on the display will blink to warn you. If a correct value is not set for the Clipboard In or Out points, a warning message of "Void In Point!" or "Void Out Point!" will appear.

* Refer to page "85" for more information about copying data.

32. Auto Punch Mode On/Off key [AUTO PUNCH]

Switch this key ON for auto punch in/out.

When you press this key while a correct value is stored to the AUTO PUNCH IN key and the AUTO PUNCH OUT key, both the REHEARSAL LED and TAKE LED will blink, indicating that Auto Punch mode is on. (If a correct value is not stored, pressing the AUTO PUNCH key will not turn the parameter ON, and the message "Void Out Point!" will appear.)

Pressing the PLAY button under this condition will put the unit into "Rehearsal mode" for Auto Punch In/Out recording. Pressing the PLAY button and RECORD button simultaneously will put the unit into "Take mode."

There are five combinations of the REHEARSAL LED and TAKE LED that indicate the status of the unit regarding auto punch recording:

<Note>

If a correct value is not stored, pressing the AUTO PUNCH key will not enable the function, and the message "Void Out Point!" will appear.

If a correct value is not stored, pressing the AUTO PUNCH key will not turn on the function, and the message "Void Out Point!" will alert you. In this case, set a correct value for the Auto Punch In/Out point. Also, the function is not turned on when you press the AUTO PUNCH key if the disk does not have enough recording space. The display will indicate ".**h**m**s**f Over."

| | |
|---|---|
| Auto Punch mode OFF | Both REHEARSAL LED and TAKE LED are off. |
| Auto Punch mode ON | Both REHEARSAL LED and TAKE LED are blinking. |
| Auto Punch Take mode | Only the TAKE LED (red) is lit. |
| Auto Punch Rehearsal mode | Only the REHEARSAL LED (green) is lit. |
| Rehearsal mode entered by means of MMC or foot switch | Only the REHEARSAL LED (green) is blinking. |

* Refer to page "75" for more information about the Punch In/Out.

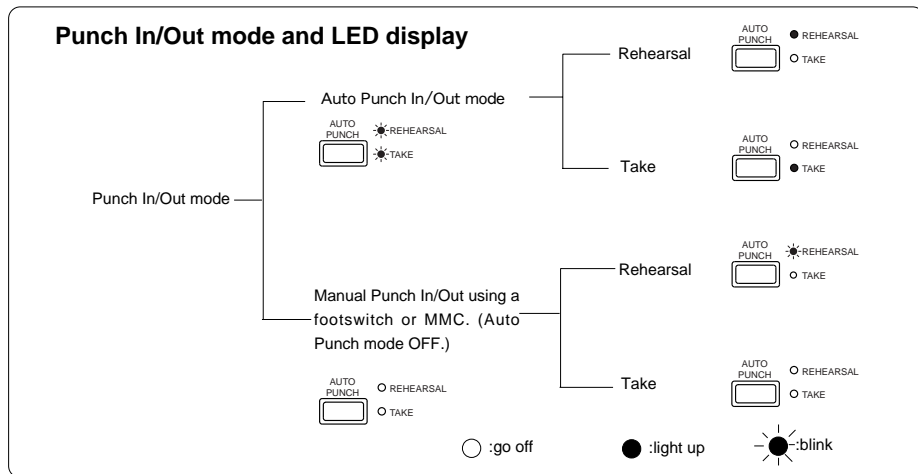

33. Locate key [LOCATE]

Press this key to locate a position.

You can locate a point (memory data) (time, or bar/beat/clock) stored in the Memory keys when you press a Memory key (CLIPBOARD IN, CLIPBOARD OUT, AUTO RTN START, AUTO PUNCH IN, AUTO PUNCH OUT, or AUTO RTN END), and then press the Locate key.

Data stored in the Locate key is the most-recently located position expressed as a time value (bar/beat/clock). If you wish to locate the same point repeatedly, then press this key repeatedly. If you locate a position at a different time value or bar/beat/clock value, the data will be updated. Pressing the RECALL key, and then the LOCATE key will display the data stored in the LOCATE key (time or bar/beat/clock), and put the D-160 in the data edit mode. To edit the data, use the HOLD/> key or the SHUTTLE dial to move around the digits, and then use the JOG dial to change their value.

When you finish editing the data, you can store a particular locate point by pressing the STORE key, and then the LOCATE key. You can also store a locate point by pressing the STORE key, and then the LOCATE key while the recorder's current point is shown. Also, pressing the HOLD/> key to enter data edit mode, and then pressing the LOCATE key when you finish editing, will allow you to locate the edited position (bar/beat/clock) directly. This data can be stored individually to each Program P1-P99.

In the SETUP mode, you can also save and load the song data to and from each Program individually. The data will be retained after you turn off the power to the unit.

* Refer to page "67" for more information about the Locate function.

34. Record button [RECORD]

Pressing only this button places the readied tracks into input monitoring status.

Pressing this button again will reset the tracks to playback monitoring. (The RECORD LED will blink when the readied tracks are in input monitoring status.)

Pressing the PLAY button while holding down this button will place the readied tracks into recording. At this time, the PLAY LED and RECORD LED will light, and the readied track indication will be light steadily (instead of blinking).

* Refer to page "37" of the "Before Operating" section for more information about input monitoring and reproduce monitoring.

35. Stop button [STOP]

Pressing this button will stop the transport section of the recorder.

Pressing the PLAY, REWIND, or F FWD button while holding down this button will cause the D-160 to perform the following operation:

| | |
|---------------|---|
| STOP + PLAY | Clipboard playback (The STOP LED will flash and the PLAY LED will light up.) *3 |
| STOP + REWIND | Locate ABS 0 *4 |
| STOP + F FWD | Locate ABS END *5 |

Pressing the STOP button will abort the editing operations and display the current position of the recorder, if you wish to:

- * quit the data edit mode,
- * cancel the recall or store operation,
- * quit the pitch data display,
- * cancel the edit operation, such as pasting, or
- * cancel the SETUP menu settings.

Pressing the foot switch while holding down this button allows you to turn the punch in/out rehearsal mode ON/OFF.

***3 Clipboard playback:**

The D-160 plays back the copy data or move data for the Clipboard. During audio playback of the copy or move data, the FL will display the time length and data type ("Copy Clip Play!" or "Move Clip Play!"), and the copy or move source track indicator will flash, enabling you to quickly determine the track and data type.

***4 Locate ABS 0:**

The D-160 will locate the top of the selected Program (ABS TIME: 00m: 00s: 00f).

***5 Locate ABS END:**

The D-160 will locate the end of the recorded data on the Program (ABS END).

* These operations can be executed only on real tracks 1 ~ 16.

- * Refer to page "32" of the "Before Operating" section for more information about ABS 0 and ABS END.
- * Refer to page "81" for more information about Punch In/Out recording using the foot switch.

36. Play button [PLAY]

Pressing this button will cause the recorder to play back.

Pressing this button while holding down the RECORD button will start recording.

Pressing this button while holding down the STOP button will perform the Clipboard playback operation. Refer to the section "STOP Button" for more information on the Clipboard playback.

Pressing the PLAY button during recording will stop recording.

37. Rewind button [REWIND]

Pressing this button while the recorder section is stopped will rewind data at 30 times speed. Pressing this button in Play mode will cue data (you can hear sound while rewinding) at five times speed.

Pressing this button while holding down the STOP button will perform the "LOCATE ABS 0" operation, and immediately locate the beginning of the Program (ABS TIME: 00m: 00s: 00f). (Refer to the "STOP button" section for more information about LOCATE ABS 0.)

38. Fast Forward button [F FWD]

Pressing this button while the recorder section is stopped will fast forward data at 30 times speed. Pressing this button in Play mode will cue data (you can hear sound during the fast forward operation) at five times speed.

Pressing this button while holding down the STOP button will initiate the "LOCATE ABS END" operation, and immediately locate the end of the recorded data on the Program (ABS END). (Refer to the "STOP button" section for more information about LOCATE ABS END.)

39. Locked LED [LOCKED]

The Locked LED will blink when the D-160 is setup as slave mode. It will light on when the lock is achieved.

- * Refer to page "123" for more information about "Slave Mode Function."

40. Hard disk access LED

This LED lights up or blinks when the hard disk is writing or reading data.

<CAUTION>

Do not turn the power off while this LED is lit or blinking. Otherwise, data on the hard disk may be damaged.

41. MIDI Time Code In LED [MTC IN]

This LED lights up when MTC (MIDI Time Code) is input from an external MIDI device to the MIDI IN connector of the D-160.

42. Punch In/Out jack [PUNCH IN/OUT] (Connector: PHONE jack)

Connecting the optional foot switch will let you control punch In/Out (and rehearsal) recording. Use a Fostex Model 8051 foot switch.

<Note>

Be sure to use an "unlatch type" foot switch if you use a foot switch other than the Model 8051. Otherwise, a malfunction could occur.

* Refer to page "81" for information about Punch In/Out recording using the foot switch.

<Rear Panel>

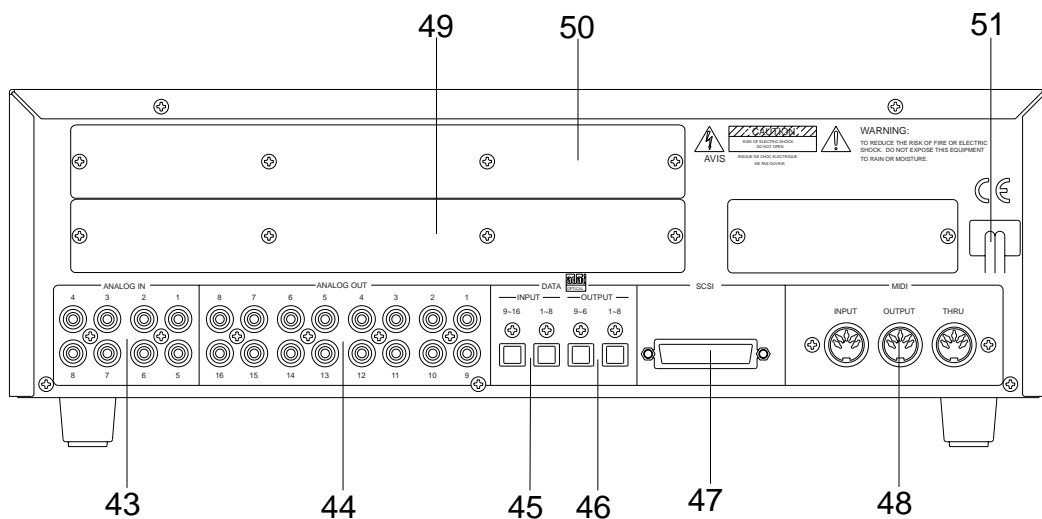

43. Input jack [ANALOG IN 1-8] (connector: RCA pin)

Analog audio signal from the mixer is routed here.

Connect this jack to the Group out (BUSS OUT) connector of the mixer.

44. Output jack [ANALOG OUT 1-16] (connector: RCA pin)

Analog audio signal of the D-160 is output here.

Connect this jack to the TAPE IN connector of the mixer.

45. Data Input connector [DATA INPUT 1-8, 9-16] (connector: OPTICAL)

Use this connector to load song data (audio + setup data) from an external device to the D-160. It is also used to input S/P DIF digital signal (from a DAT, CD, or MD) or adat digital signal (from RD-8, CX-8, or adat). DATA INPUT 9-16 is constantly fixed to "adat" input.

* Refer to pages "102" and "165" for information about "LOAD" function.

* Refer to page "60" for information "Digital Recording."

<Note>

Use the DATA INPUT 1-8 connector to load song data to the D-160.
Do not use the DATA INPUT 9-16 connector with load .

46. Data Output connector [DATA OUTPUT 1-8, 9-16] (connector: OPTICAL)

Use this connector to save song data (audio + setup data) from the D-160 to an external device. It is also used to output S/P DIF digital signal or adat digital signal to an external digital device. DATA OUTPUT 9-16 is constantly fixed to "adat" output.

<Note>

Use the DATA OUTPUT 1-8 connector to save song data from the D-160.
Do not use the DATA OUTPUT 9-16 connector with save.

* Refer to pages "102" and "168" for information about "SAVE" function.
* Refer to page "60" for information "Digital Recording."

47. SCSI connector [SCSI] (connector: D-sub 25-pin)

This is the connector which enables an external SCSI device to be connected.
It allows you to save or load song data.
Use the D-sub 25-pin cable for Macintosh designated by each SCSI device.

* Refer to pages "108" and "166" for information about "SCSI."

48. MIDI Input/Output/Thru connector [MIDI INPUT/OUTPUT/THRU]

(connector: DIN 5-pin)

MIDI INPUT:

Connect the MIDI OUT connector of an external MIDI device here.
The D-160 can be controlled remotely via an external MMC (MIDI Machine Control) or FEX (Fostex System Exclusive Message).

MIDI OUTPUT:

Connect the MIDI IN connector of the external MIDI device here.
The D-160 will output MTC (MIDI Time Code), MIDI Clock signal, MMC (MIDI Machine Control) response, and FEX (Fostex System Exclusive Message) response.

MIDI THRU:

This connector outputs the input signal at the MIDI INPUT connector without modification.
When using multiple D-160s via MIDI, connect this terminal to the MIDI INPUT connector of the second D-160. Refer to page "117" for details.

49. Panel A for an optional card

This is the panel used for installing the optional Model 5041 (balanced 8-16 I/O card).
Using the Model 5041 allows for balanced analog signal input and output. In general, leave the panel in place.

50. Panel B for an optional card

This is the panel used for installing the optional Model 8345 (D-160 TC/SYNC card).
Using the Model 8345 makes the D-160 have LTC input and output connectors.
Also, the sync lock with video and word clock will be possible. In general, leave the panel in place.

51. Power cable

Connect the power cable to an AC outlet of the specified voltage.

<Display Section>

The D-160 display integrates the level meter of a high-visibility FL tube with a 16 digits and 35 dot message display.

The level meter shows the Track 1-16 output level of the recorder section. The time display shows the current time of the recorder section using ABS TIME (Absolute time), MTC (MIDI timecode), or MIDI BAR/BEAT (bar/beat). This display also shows messages required for interactive operation. The following section explains the display functions and provides with some examples.

1. Display shown when the power is turned on

When you turn on the power to the D-160, the display shows "Initializing..." (Initializing. Please wait.), and the time display shows the time using the time base (ABS, MTC, or BAR/BEAT/CLK) that was selected before the power was turned off.

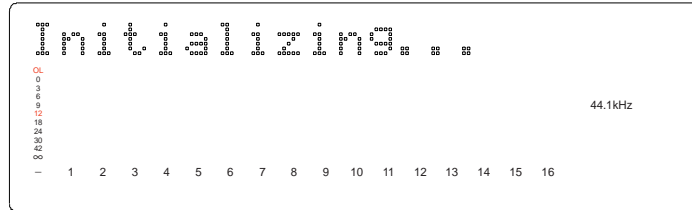

2. Preset display

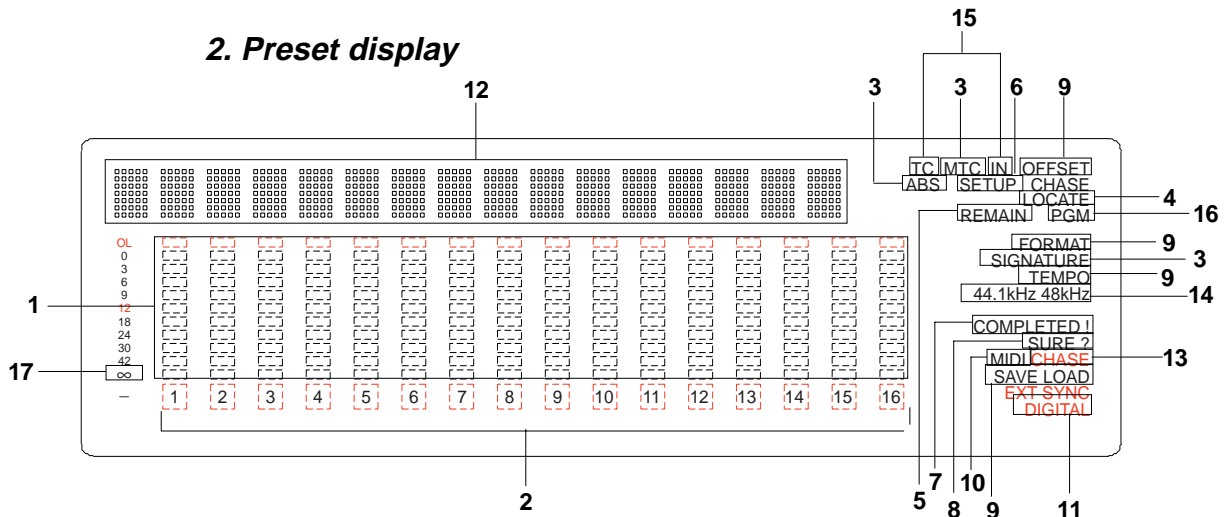

1. Level meter

The level meter shows the recorder output level and the recording level for Tracks 1-16.

2. Track indication

The track indication blinks when the corresponding track is ready. It turns off when the track is safe, and is lit during recording.

3. ABS, MTC, SIGNATURE

When Time Base uses ABS time, "ABS" lights up. With MTC time, "MTC" lights up, and with BAR/BEAT/CLK indication, "SIGNATURE" lights up.

4. LOCATE

This LED lights up when the unit enters data edit mode, enabling you to edit data. Pressing the LOCATE key while this LED is lit will cause the D-160 to locate the position of the displayed time or the bar/beat/clock value.

5. REMAIN

Refer to "2. Switching the display using the DISP SEL key."

6. SETUP

Refer to "2. Switching the display using the DISP SEL key."

7. COMPLETED!

This message indicates that an operation such as copy, move, and paste has been completed.

8. SURE?

This message is shown to confirm whether or not you wish to execute a certain operation.

9. LOAD, SAVE, FORMAT, MTC OFFSET, TEMPO

When the unit enters Setup mode, the selected parameter name will appear here. The parameter name also appears on the 35 dot message Display.

10. MIDI

This indication lights up when the D-160 receives effective MIDI messages from an external MIDI device.

11. DIGITAL

This indication lights up when the D-160 is receiving a digital signal properly at the DATA INPUT connector while loading data from a external digital equipment (CD, MD etc.). If this indication is blinking, the digital signal is not being received correctly.

12. 35 dot message Display

This display indicates the ABS time, MTC time, BAR/BEAT/CLK time value or bar/beat/clock value, a Program number, and a parameter name in the Setup mode.

13. CHASE

This indication flashes when the D-160 is in Slave mode, and lights up when the unit locks to the sync signal.

14. 44.1kHz, 48kHz

This displays the sampling rate of the Program you are currently working. During DIGITAL input of S/P DIF, the 44.1kHz or 48kHz indication will blink when the FS setting is different between the digital signal that is input and that in D-160.

15. MTC IN, TC IN

With the optional Model 8345 TC/SYNC card installed, this will be lit when MTC or LTC is externally input.

16. PGM

This flashes when the D-160 is entered in the program setup and program change modes.

17.

At playback of a no sound section, if the FL tube "∞" symbol only is lit, the level of that track will be lower than 43dB but it also indicates that an Audio File exists in the lighted track.

You proceed as is but the hard disk is occupied in excess by this Audio File. If this Audio File is unneeded, disk capacity can be economized by erasing this section. Likewise, during playback, if nothing is lit in the FL tube "∞" section, it means that Audio data of this track is "ALL 0" and the hard disk is not occupied by this.

3. Switching the display using the DISP SEL key.

Let's assume that you turned off the power while the time display was using a time base of "ABS," and then you turned the power on again. The D-160 time display will again use a time base of "ABS." (Underline->Displayed program number)

ABS TIME display

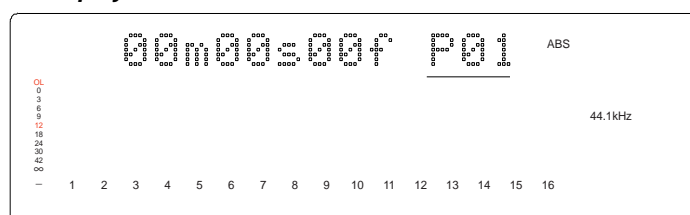

At this time if you press the DISP SEL key, the Disk Remain display will appear. (Both recordable time and hard disk capacity remaining will be converted to mono track and expressed in time and megabites.)

DISK REMAIN display

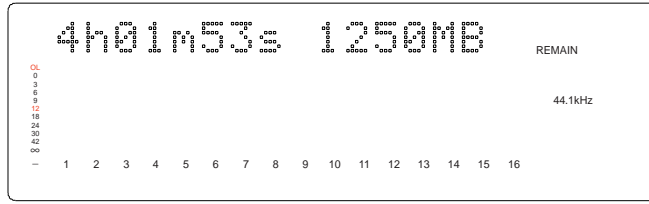

If "BAR/BEAT/CLK" is selected for the timebase (explained later), the DISK REMAIN indication will show a value (in terms of the number of measures) calculated based on the last beat/tempo data on the tempo map of the recorded song.

When you press the DISP SEL key again, the Setup mode display will appear. At this time, the D-160 has not entered the Setup mode. To put the D-160 into the Setup mode, press the EXECUTE/YES key. After pressing the EXECUTE/YES key, if you wish to go back to the previous status, press the EXIT/NO key.

Setup mode display ("SETUP" indication is flashing)



If you press the DISP SEL key again, the screen will return to the "ABS TIME" display.

4. Switching the Time Base display using the EXECUTE/YES key and DISP SEL key

When the screen is showing the ABS TIME or REMAIN display, if you press the DISP SEL key repeatedly while holding down the EXECUTE/YES key, the TIME BASE display will change cyclically. You can select one of the following Time Base displays.

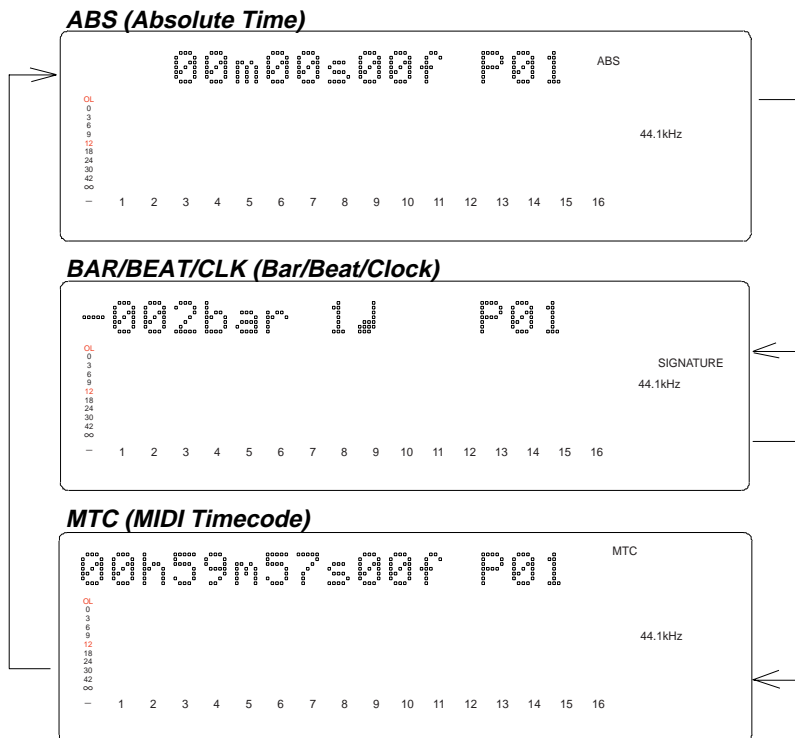

5. Changing Programs using the STORE key and the HOLD/> key

* About the Program Change function

The Program Change function divides the hard disk space into up to 99 parts to accommodate 99 separate Programs (P01-P99 — as long as available recording time allows) so you can record, play back, edit, and archive (save and load) data for each Program individually.

For example, the first song can be Program 1, the second song can be Program 2, etc. You need to recall the desired Program before you start recording, playback, editing, or archiving.

Pressing the STORE key while holding down the HOLD/> key will cause the D-160 to enter Program select mode, display the message “Select PGM!”, followed by the current Program and Program number and a flashing “SURE?” indication.

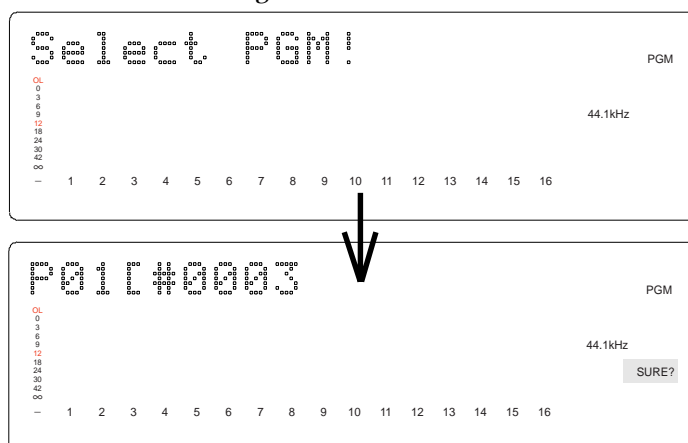

You can select the desired Program from the already setup Programs by rotating the JOG dial while the Program number and “SURE ?” are flashing. (“#0003” is the current program title.)

After you select a Program, press the EXECUTE/YES key to return to the selected Program’s ABS indication.

The Time Base display will indicate the selected Program’s Time Base, since you can set the Time Base for each Program individually.

To change the Time Base display after you have selected the desired Program, press the DISP SEL key while holding down the EXECUTE/YES key.

Pressing only the DISP/SEL key will take you to the REMAIN display based on the current Time Base.

<Notes>

* If you turn the JOG dial while the ABS display or MTC display indicates a Program number, the Program number indication will change to the sub-frame indication. However, if you operate a transport button, such as the PLAY button or the Stop button, or if you turn the SHUTTLE dial, the sub-frame indication will change back to the Program number indication. (The Program number shown on the BAR/BEAT/CLK display will not change.)

* The maximum total recording time of all setup Programs (up to 99 Programs) equals the available recording time of the hard disk. For example, if you use an optional Model 9041 (1.3GB removable hard disk cartridge), the available 16-track recording time is about 15 minutes (with a sampling rate of 44.1kHz). If you have recorded 10 minutes of data in Program 1, you can record 5 minutes for the total time of the rest of Programs. That is, you can record data totalling 15 minutes, regardless of whether you use all setup Programs or record only one Program.

* Refer to “2-1. Setting up a Program” and “2-2. Program Change” on pages 49-51 for more information on how to setup a new Program and use the Program Change function.

6. Warning messages

If you perform an incorrect operation, input incorrect data, or if an error occurs, the following alarm indication appears:

Invalid data indication (The input data is not appropriate for the operation).

Action to take:

Input correct data.

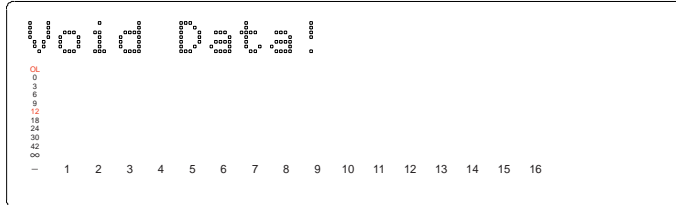

Invalid In/Out indication (The In or Out point is not appropriate for the operation).

Action to take:

Input correct data.

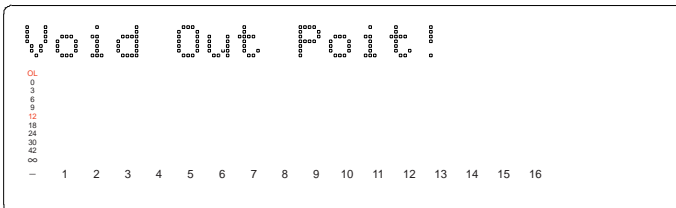
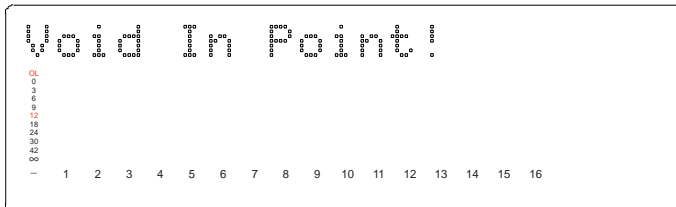

Overtime indication (Available disk space is insufficient for the length of time (the number of measures) indicated on the display.)

Action to take:

During the copy & paste and move & paste operation, try to shorten the length of the copied data by the indicated amount. Alternatively, use the "ERASE" function to move the ABS END point backward to obtain enough disk space for editing.

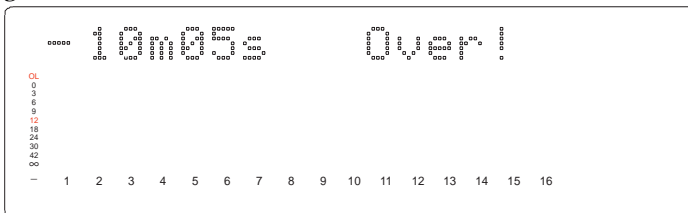

Unassigned track indication (Select any track)

Action to take:

Use the RECORD TRACK select key to ready any track.

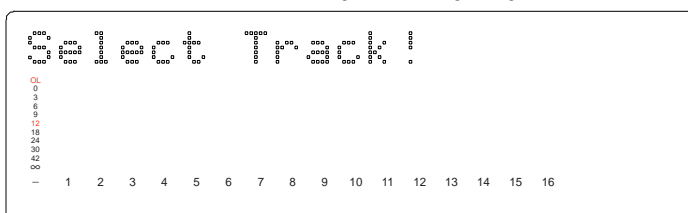

Event overflow indication (The editing points are overflowed)

Action to take:

You edited too much. The warning means "you cannot paste or erase any more."
In regards to event, refer to "Event and Audio File" in Before Operating section.

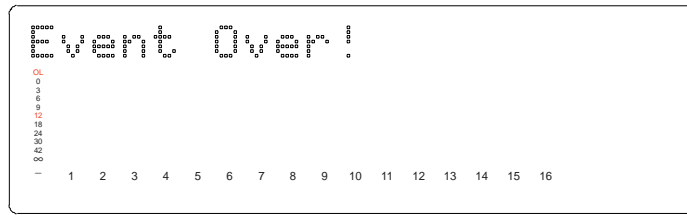

Load error indication (You cannot load data because the data input to the DATA INPUT connector contains an error)

Action to take:

Check to see if there is an abnormality with the external digital machine connected to the DATA INPUT connector, or cable. Try to "LOAD" again.

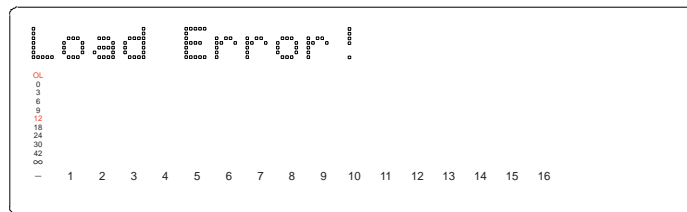

Un-formatted indication (The internal hard disk is damaged or not formatted yet.)

After this message is shown for about 10 seconds, "FORMAT" in Setup mode will flash on the display. Pressing the EXECUTE/YES key at this moment will erase all data and reformat the hard disk.

Action to take:

Press the EXECUTE/YES key to format the disk. (All audio and other data on the disk will be lost.)

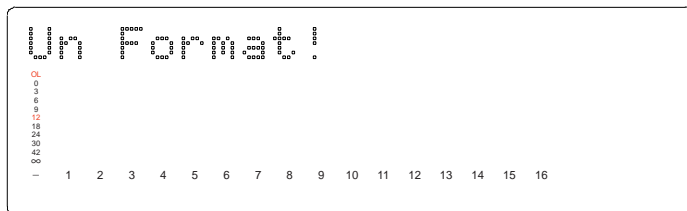

Disk error indication (This disk cannot be read)

Action to take:

Contact the Fostex service station as soon as possible.



Recording Disable (Recording is disabled.)

Action to take:

Change the "Off" (recording) "Rec Protect ?" setting in Setup mode.

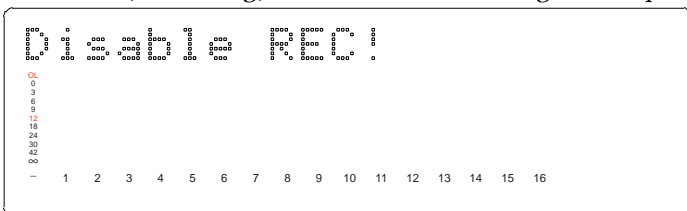

SCSI device connection error: (The SCSI device is not connected correctly.)

Action to take:

Check to see if the external SCSI device is connected to the SCSI connector correctly, or the power to the SCSI device is turned on.

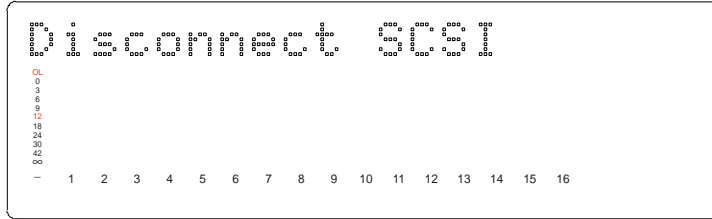

Disk Lock error: (The hard disk is not installed correctly, or not securely locked by the key.)

Action to take:

Install the hard disk correctly or confirm that the disk is set properly, and be sure to lock it using the included key.

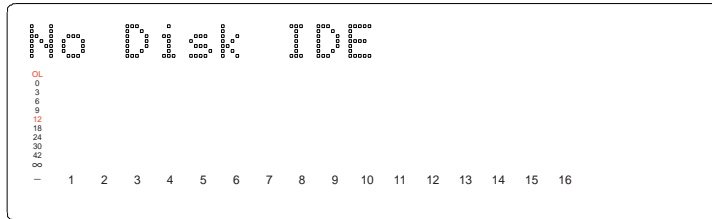

In rare case, the "No Disk IDE" will also be displayed if the cartridge connector pins are soiled. In such a case, clean the connector pins with alcohol or its equivalent.

When cleaning, however, be extremely careful not to generate static electricity.

SCSI save error: (Occurrence of an error during execution of save into SCSI equipment)

Action to take:

Because "Retry?" will be displayed when the EXIT/NO key is pressed, if save is to be executed again, press the EXECUTE/YES key upon display of "Retry?."

If save is to be canceled at this stage, press the EXIT/NO key again.

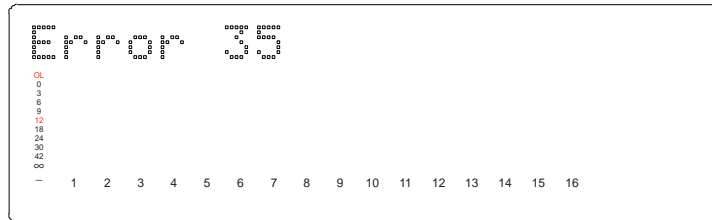

SCSI load error: (Occurrence of an error during execution of load from SCSI equipment)

Action to take:

Because "Retry?" will be displayed when the EXIT/NO key is pressed, if loading is to be executed again, press the EXECUTE/YES key upon display of "Retry?."

If loading is to be canceled at this stage, press the EXIT/NO key again.



Before Operating the D-160

This section explains the following items that you should learn before you start operating the D-160.

1. Hard disk recording method and the REMAIN display
2. Audio file and event
3. Program Change function
4. Real track and additional track
5. Input monitor and reproduction monitor
6. Time base
7. Installing and formatting a hard disk
8. Expanding a detachable controller

1. Hard disk recording method and the REMAIN display

The D-90, D-80, and DMT series are able to play back only within a recorded area (ABS 0 - ABS END), but unable to play or fast forward after the record end point (ABS END) as shown in the diagram below. They can start recording only from the ABS END point.

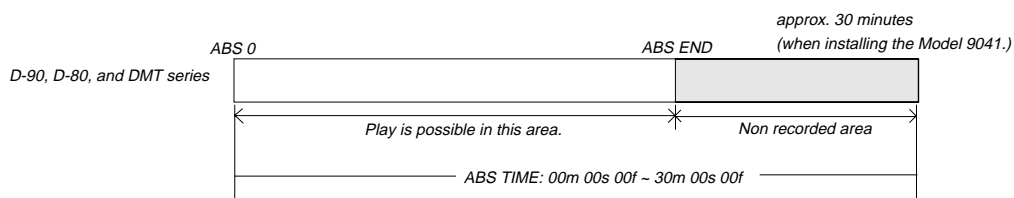

On the other hand, the D-160 enables you to select any ABS time position within 24 hours to record an audio signal on the formatted hard disk. (Refer to the diagram below.) For example, if you are using an optional Model 9041 (1.3GB removable hard disk cartridge), you can record about 15 minutes to all 16 tracks anywhere within the range of 24 hours. (The REMAIN display will indicate 240 minutes since the D-160 calculates the remaining free space based on a mono track.)

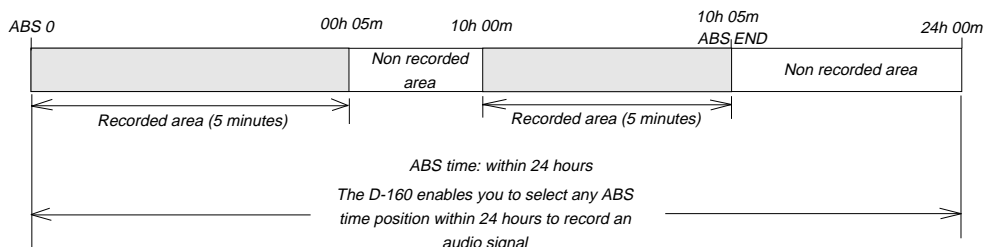

If you recorded five minutes of 16-track data starting at 00h:00m:00s:00f:00sf (ABS 0), then recorded another five minutes of data starting at 10h:00m:00s:00f:00sf, the ABS END point would be at the end of the second recording, 10h:05m:00s:00f:00sf. This does not mean that the recording on the hard disk is 10 hours 5 minutes long. The total recorded time on the disk would be 10 minutes (two 5-minute recordings). In this case, if you try to play the unrecorded area (00h:05m through 10h:00m), the display will count down the time, but the D-160 will not access the hard disk. The same applies to the area after the ABS END point. If you try to play or fast forward in the area after the ABS END point, the display will count down to one frame before 24 hours (based on the frame rate specified in Setup mode). However, MTC will be output during the playback of an unrecorded area.

In this example, pressing the DISP SEL key will switch to the REMAIN display that indicates about 80 minutes (based on a mono track). This is a recordable duration when data is recorded in a single track. As mentioned, above the REMAIN display will indicate 240 minutes when you are using an optional Model 9041 (1.3GB removable hard disk

cartridge.) This means that you can record total 240 minutes of data with a sampling rate of 44.1kHz in a single track.

Recording one-minute, one-track data with a sampling rate of 44.1kHz on the D-160 requires approximately 5.3MB of hard disk space. Therefore, the amount of space required for a particular recording should be obtained by multiplying 5.3MB by the number of tracks by the number of minutes (duration). If the REMAIN display indicates 240 minutes based on a mono track, you can record about 15 minutes of 16-track data. If you have recorded 10 minutes of 16-track data, you would have used the hard disk space corresponding to 160 minutes (16 tracks times 10 minutes). The resultant REMAIN value would be $240 - 160 = 80$ minutes.

2. Audio file and Event

As described in the previous section “Hard disk recording method and the REMAIN display,” the basic recording method differs between the D-90/D-80/DMT series and D-160. The D-160 contains sequential individual audio files recorded in the tracks of a Program. You can insert silence between these audio files. The silence will be counted as a zero file. As shown in the diagram below, audio files and zero (0) files will be recorded alternately.

“The number of events” of a certain track is calculated by adding up the number of these audio files and zero files. Each track can contain up to 512 events, but the D-160 will not record new data when the recording reaches the event 508.

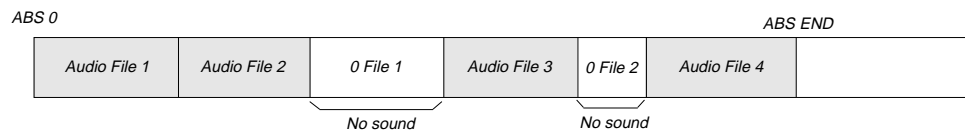

Usually, a single event is created by one recording or editing operation, and the number of the events changes according to the edit point or the amount of available disk space. (The D-160’s disk management generally tries to reduce the number of events.)

This does not create problems in most music production. However, if you make frequent recordings with zero files in between the audio files, the number of the events could exceed the limit. In order to prevent this, you need frequently to check the number of events on each track during a session.

Use the “NOs Of Event?” menu in Setup mode to check the number. Refer to “NOs Of Event?” menu in Setup mode” on page "163."

<Note on Digital In recording>

No “0 file” is created during analog recording, because data 0 will not continue even when silence is being recorded. On the other hand, if you are recording data via S/P DIF or adat input, the D-160 will create a zero file when 0 data is consecutively input for one second to save disk space. This increases the number of events. Watch out for “the excessive number of events.”

What is an event?

As shown in the diagram below, the number of events can be eleven or more if partial recordings are made. This is because an unrecorded part is regarded as an event, and a recorded part is also regarded as an event(s). The duration of each event can vary from 740 msec to 23 hours 59 minutes 59 seconds (FS = 44.1kHz).

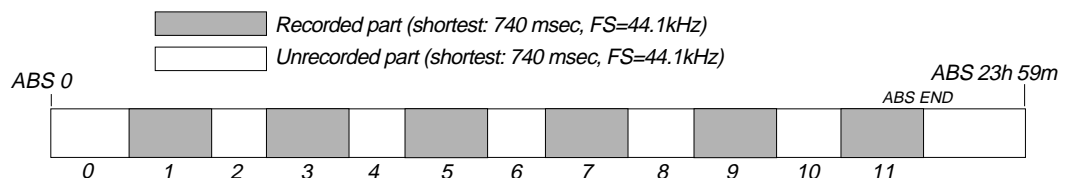

An unrecorded part (zero file) is always regarded as one event, regardless of its duration. However, a recorded part can consist of a group of multiple audio files, as shown in the diagram below.

More precisely, one audio file will be divided into multiple audio files if perform many editing operations (such as, copy & paste, move & paste, etc.) on this audio file. Multiple audio files created in this way are regarded as events. (If you do not edit the data at all, the audio file remains in one piece and is regarded as one event.)

In this example, one recorded area consists of six consecutive audio files. This means that this part consists of six events.

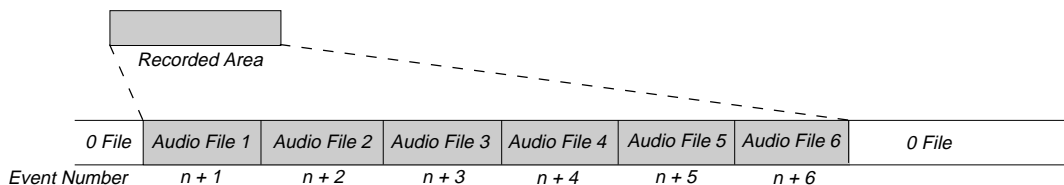

This is because when you perform a copy & paste, move & paste, or Auto Punch In/Out, the event is split at the edit point. Also, if a continuous long recording is made, the recorded data might scatter to different locations on the hard disk, thus dividing the data into multiple events.

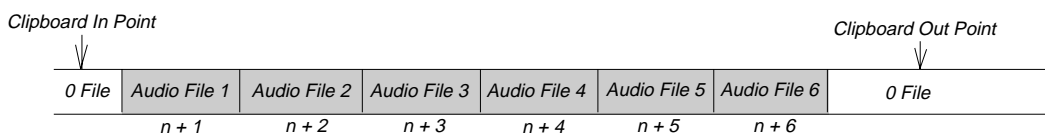

Countermeasures against accumulating too many events due to a long recording plus many editing operations:

One solution is to save and re-load the data to and from a DAT, Adat, or SCSI device. (If the song is too long, you may not be able to save the data to a DAT or Adat.)

In this way, multiple consecutive audio files are optimized into one continuous audio file in some cases.

If you know which part of the data you edited, and if the hard disk has enough free space, you can use another solution in some cases.

Set the Clipboard In point and the Clipboard Out points within an unrecorded range to copy the area (the area that contains multiple audio files and you wish to optimize) between them, then paste the data starting from the same Clipboard In point.

Multiple audio files within this range will become a single audio file.

<Hint>

Make sure that you set the Clipboard In/Out points within zero files, and that you paste the area starting from the SAME Clipboard In point.

* In any case, bear in mind that you cannot reduce the excessive number of events if the target range contains a zero file.

3. Program Change function

The D-160 features a Program Change function, which enables you to setup as many as 99 Programs on a single hard disk, and record and edit up to 99 separate songs. You can also name (title) each Program.

Using an analogy, imagine that each Program has its own room on the hard disk. You can record, play, and edit each Program without affecting other Programs.

Assume that you have made a six-minute mono-track recording in Program 1, then you have setup Program 2 and made a 10-minute, mono-track recording to the Program. Now, the hard disk contains two rooms (total 16 minutes). (You can setup a maximum of 99 Programs.)

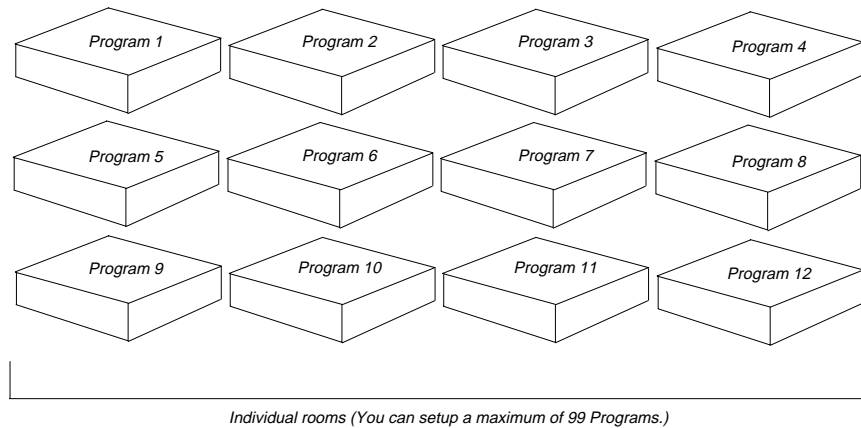

In the default setting, one Program has been setup. If you wish to setup more Programs, refer to “Recording/Playback, 2-1. Setting up a Program.”

Please remember, however, that regardless of the number of Programs you setup, the total recording time of the Programs cannot exceed the maximum available time of the hard disk.

For example, if you are using a Model 9041 (1.3GB), you can record up to about 15 minutes on all 16 tracks (with a sampling rate of 44.1kHz), or up to 240 minutes on a single mono track. Therefore, if you have already recorded a 15-minute, 16-track song in Program 1, the available recording time will remain 0, and you will be unable to record data to other Programs.

4. Real track and additional track

You can record, play back, and edit up to 16 real tracks on the D-160.

The D-160 also features eight additional tracks.

Real tracks 1-16 are used for recording, playing back, and editing.

Additional tracks 17-24 are used to store data.

More precisely, you can play back and monitor data recorded on the real tracks and check it with the level meters. But, data stored on the additional tracks cannot be monitored or checked with the level meters. The purpose of the additional tracks is to temporarily store the data recorded on the real tracks (1-16).

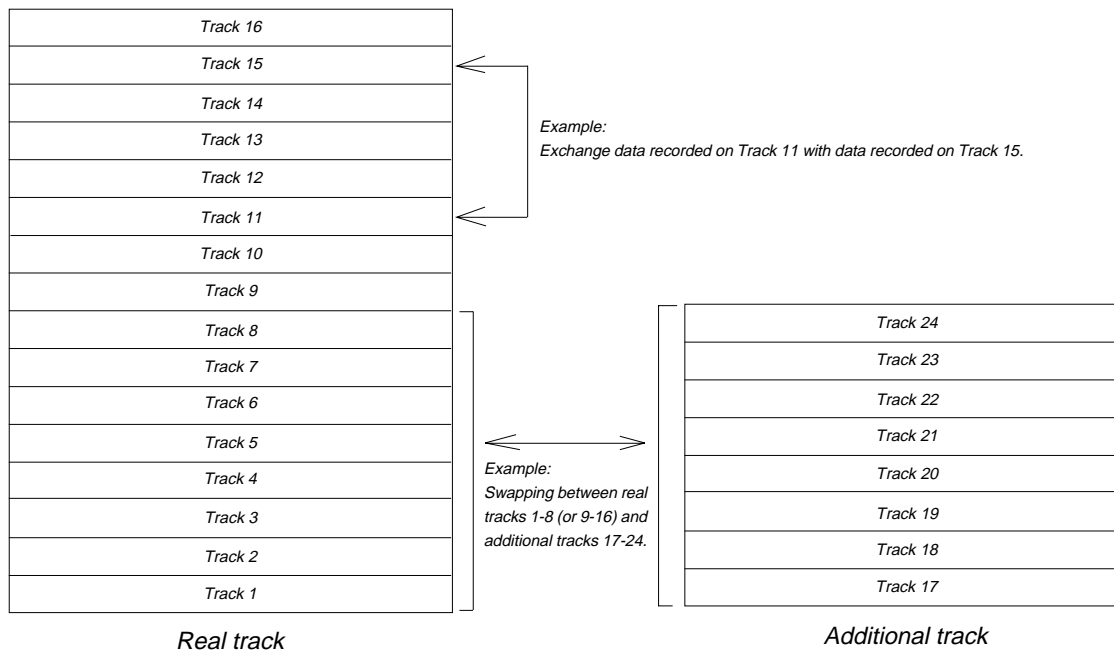

You can swap data between two tracks (between two real tracks, additional tracks, or between a real track and a additional track) using the “Track Exchange?” menu in the Setup mode.

For example, you can exchange data recorded on Track 1 with data recorded on Track 8. If you swap between a track with data and a track without data, the track that originally contained data will become empty.

You can also swap data between eight tracks; that is, swapping between real tracks 1-8 (or 9-16) and additional tracks 17-24.)

This is very convenient in a multitrack recording application when you wish to clear some tracks in order to make new recordings.

For example, if you swap between real tracks 1-8 (or 9-16) with data and additional tracks 17-24 without data, the real tracks become empty. So, you can make new recordings in these empty tracks. You can, of course, load back the data from the additional tracks to real tracks. During the save/load operation, you can also save or load both real track data and additional track data.

<Notes>

- * The D-160 always uses data on real tracks for the ABS END indication. For example, If you have moved all track data to the additional tracks and the real tracks are empty, ABS END is “0.” In order to check the ABS END point of the data in the additional tracks, you need to move the data into the real tracks. Alternatively, you can check the data status of the additional tracks by checking the events on the “NOs Of Event?” menu in Setup mode. (Refer to page “163” for more information on the “NOs Of Event?” menu in Setup mode.)
- * You cannot swap data between the tracks from two different Programs.

5. Input monitor and Repr monitor

There are two ways to monitor track data on the recorder: Input monitor and Repr monitor. These are defined as follows:

Input monitor:

Input monitoring enables you to listen to the input signal that is routed to and output through the tracks just as it is. That is, listening to (monitoring) the post-recorder input signal (not the pre recorder signal).

Sixteen tracks on the D-160 can be set to either "Input monitoring" or "Repro monitoring" status. Follow the steps below to set the tracks to Input monitor.

1. Set the track to recording status.

To set the track to recording status, first ready the track, then press the PLAY button while holding the RECORD button. The recording track will be in Input monitoring status.

Alternatively,

2. Ready the track, and press the RECORD button once. (If you press the RECORD button again, the track enters the repro monitoring status.)

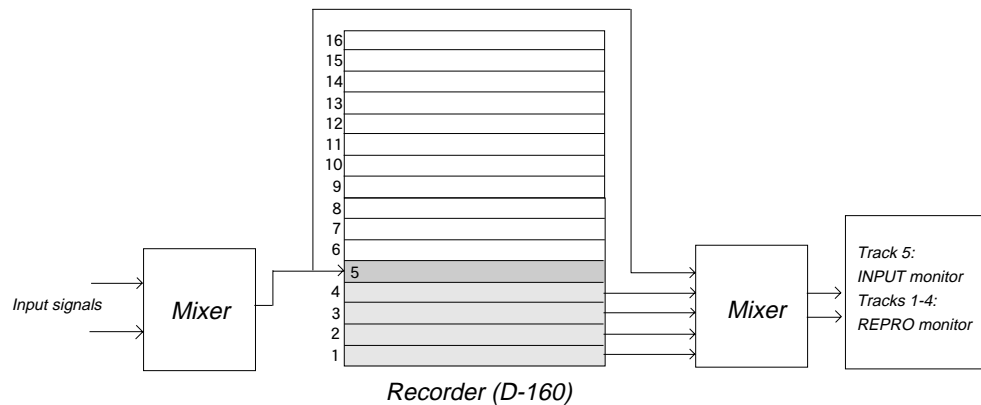

* The RECORD LED next to the RECORD button will flash, and the currently selected tracks will enter input monitoring status.

Repro monitor:

Repro monitoring enables you to monitor the playback signal on the tracks; that is, to listen to the output of the recorded signal.

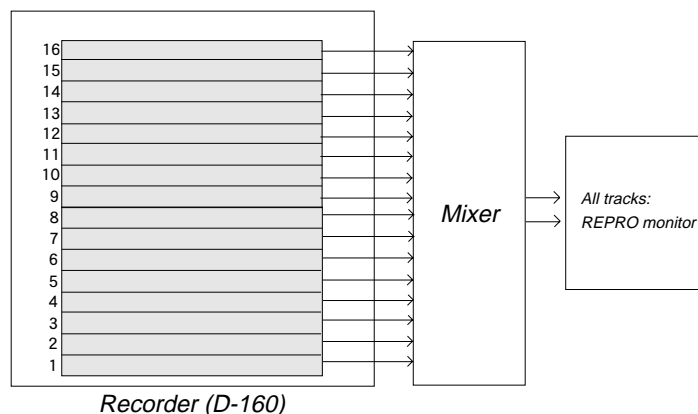

6. Time Base

The D-160 indicates the location of the recorder (the current position) using the ABS time, MTC, or MIDI Bar/Beat/Clock. This time reference is called "Time Base."

ABS (Absolute Time) refers to an absolute time on the hard disk; MTC (MIDI timecode) refers to a relative time obtained by adding a certain value (MTC offset value) to the ABS value; and BAR/BEAT/CLK (bar/♩/clock) indicates a position in a song that corresponds to the MIDI Clock/Song Position pointer and can be created using the internal Tempo Map. (The following diagram shows the relationship between the three types of time base.)

* Replace all ♩ symbols in the text with the quarter note symbol.

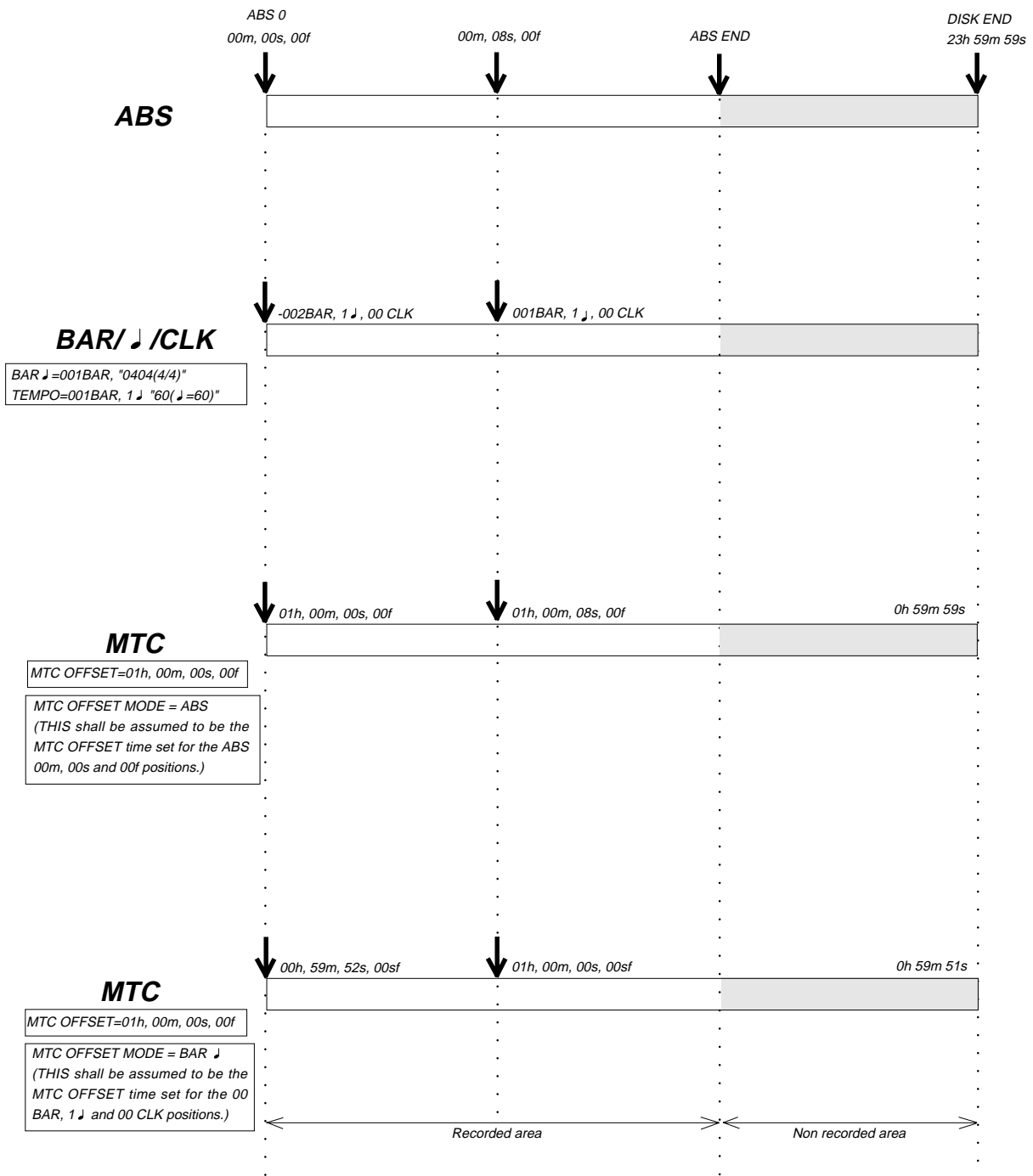

7. Installing and formatting a hard disk

The D-160 utilizes a removable hard disk cartridge, making it quick and easy to transport and replace the hard disk.

Using an optional removable hard disk cartridge Model 9041 (1.3GB hard disk built-in) or Model 9040B (empty caddy without hard disk) allows you to replace the cartridge or extend the sixteen tracks recording time very easily.

* Refer to next page for more information on replacing the removable hard disk cartridge.

You can install an ATA (IDE) standard hard disk in an optional removable case Model 9040B (without hard disk).

<Note>

Refer to the "Supplement" for more information on "Recommended Hard Disk" and "Operation-Confirmed hard Disk" lists.

<WARNING>

Plug the included dust cap onto the connector of the D-160's removable hard disk to protect the disk from static electricity, dust and dirt before you store or transport the hard disk. A hard disk is precision device. Handle it with care and avoid vibration, humidity, strong magnetic fields, static electricity, dust, etc. In particular, do not touch the connector with your hands to protect the hard disk from static electricity.

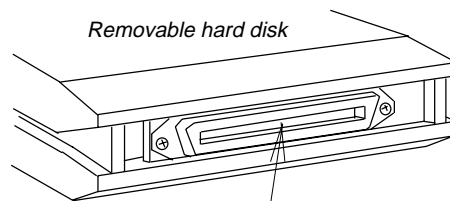

Plug the dust cap onto the connector.
(Do not touch the connector with your hands.)

Installing a removable hard disk cartridge

A hard disk cartridge is not installed in the D-160 when it is shipped. You will need to install a removable hard disk cartridge in the D-160. (You can use an optional Model 9041 or a hard disk that has been approved for performance and installed in the removable case that came with the D-160.)

Follow the procedure below to install a new hard disk cartridge. Be sure to format the hard disk. The following procedure should be performed with the power to the D-160 turned off.

1. Remove the blank panel from the cartridge slot.

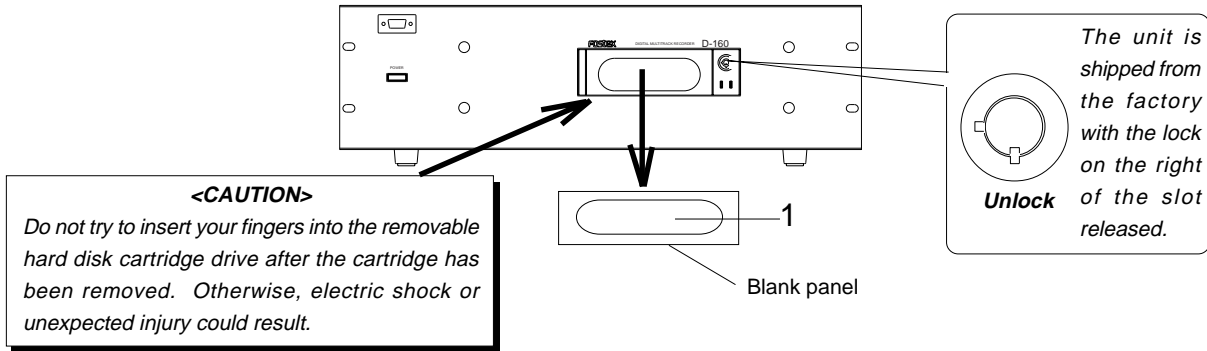

2. Insert the hard disk cartridge (e.g., Model 9041) into the slot.

Make sure that you insert the cartridge until it clicks into place. Be sure to remove the dust cap on the connector of the cartridge case before inserting the cartridge.

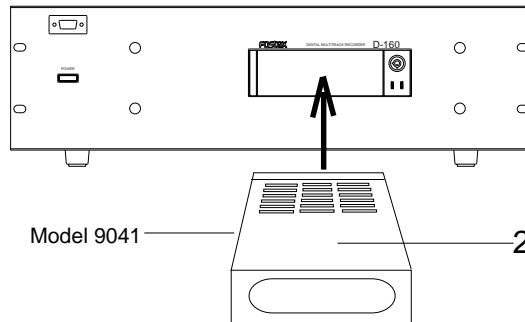

3. Lock the cartridge with the key included in the package.

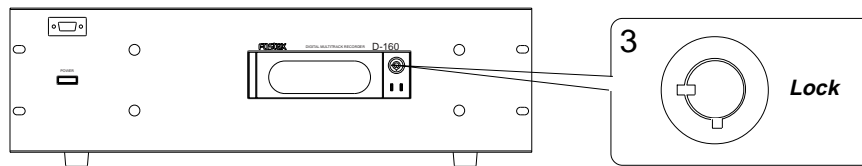

4. Connect the connector of the detachable controller, and install the controller to the D-160.

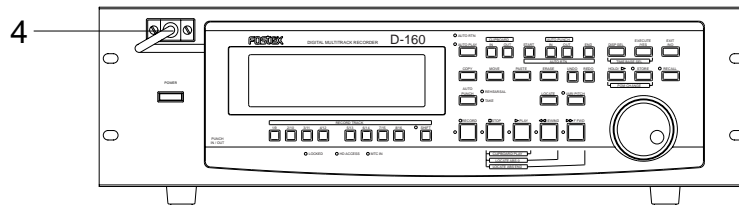

* When installation is completed, follow the procedure "Formatting a hard disk" on page "43" to format the hard disk.
 * If you are using a hard disk (that has been approved for performance) and installing it in the removable case that came in the package, refer to "Installing a hard disk in the removable case" on page "42."

Replacing a removable hard disk cartridge

Follow the procedure below to replace the removable hard disk cartridge.

1. Turn the power off to the D-160.

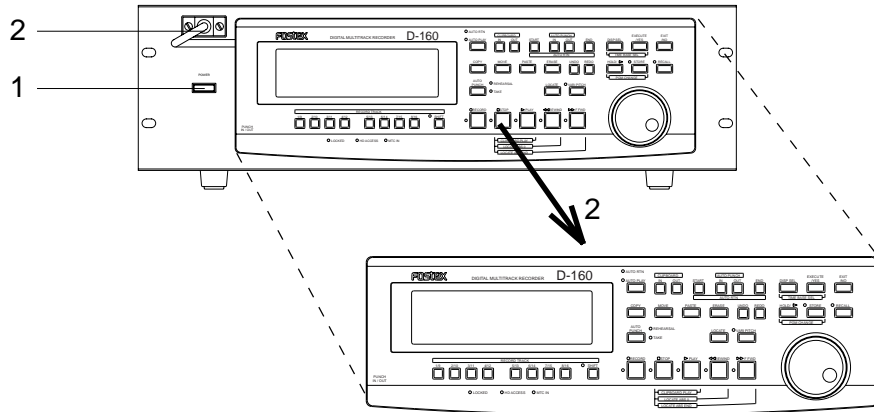

- 2. Remove the connector from the detachable remote controller section, and remove the controller section.**
- 3. Release the lock using the key included in the package. (Refer to the figure on the right below.)**

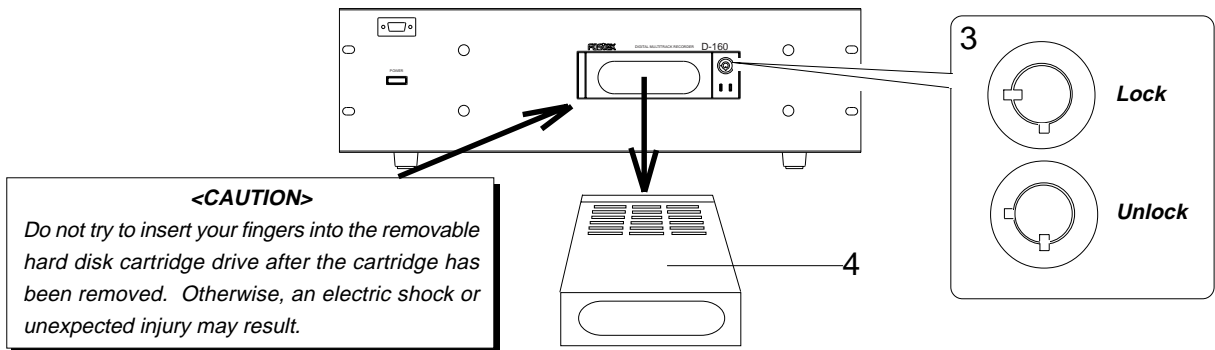

- 4. Pull the disk cartridge forward you to remove it.**
The hard disk is a precision device. Handle it with care.
- 5. Insert new disk cartridge.**
Gently push it in until a click noise is heard.
- 6. Lock the cartridge using the key. (Refer to the figure on the right above.)**
- 7. Install the controller section, and fix the connectors securely using the screws.**

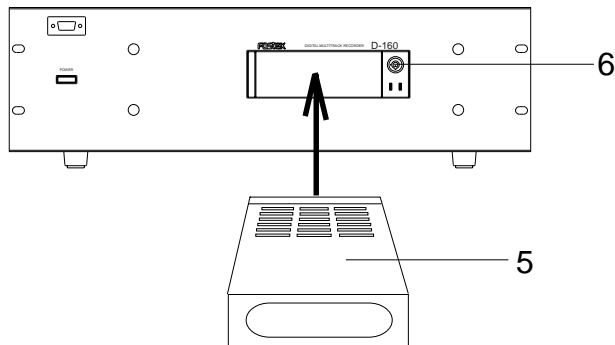

* When installation is complete, follow the procedure "Formatting a hard disk" on page "43" to format the hard disk.

Installing a hard disk in the Model 9040B removable case

If you have purchased one of the hard disks listed in the "Supplement," you need to install the disk in the included removable case or Model 9040B optional removable case. Follow the procedure below to install the disk in the removable case, and then install the case in the D-160 as explained on the previous page, and format the disk.

<WARNING>

A hard disk consists of precision parts, and is sensitive to strong shocks (such as being dropped). Handle the disk with care. Install the disk on a level, stable surface. Fostex is not responsible for any malfunction or damage caused by incorrect handling.

<CAUTION>

If any part of the disk unit touches the case bottom, paste an "insulation seal (diameter: 18mm)" included in the package of the case at the point of contact. Some disk units may have such a dimension that the part could touch the case. If you use a disk with a part touching the case, a short circuit, malfunction, or damage could result. Make sure that no part of the disk touches the case, or paste the seal.

<Note>

Be sure to set the DIP switch or the JUMPER switch on the hard disk to "MASTER" when you install the hard disk in the removable case. The disk will not operate if the setting is "SLAVE." (Refer to Hard Disk's Owner's Manual for details.)

1. Disassemble the removable case.

Refer to the diagram to remove the bottom of the case.

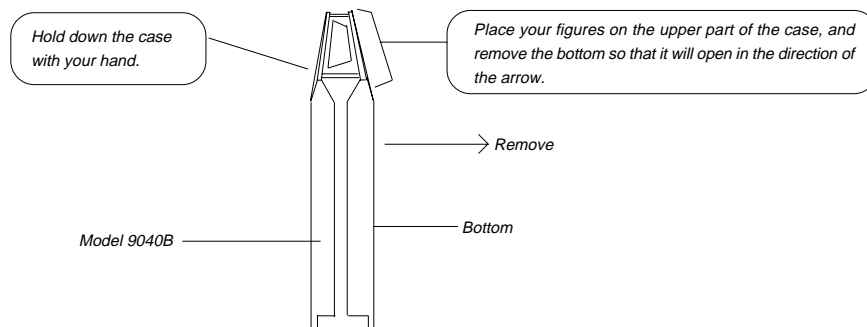

2. Insert the disk unit into the case, and connect the cable connectors on the case to the appropriate connectors on the disk unit.

<Note on connecting the connector>

Sometimes it may be difficult or awkward, due to a lack of space, to connect the connectors when you are installing a hard disk into the removable case. In this event, do not apply excessive force on the connector. Use caution to avoid injury or damage to the hard disk.

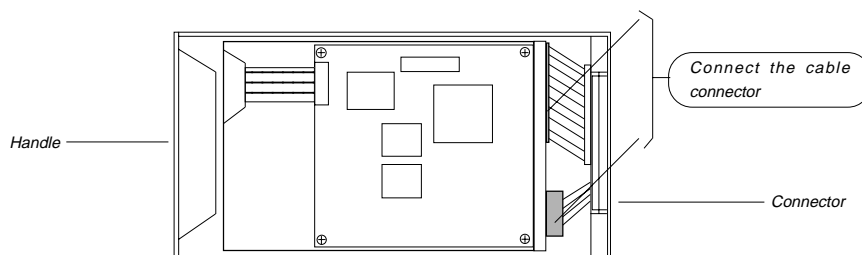

- Secure the disk unit using the screws that come with the removable case. (Use two screws on each side as shown in the diagram.)

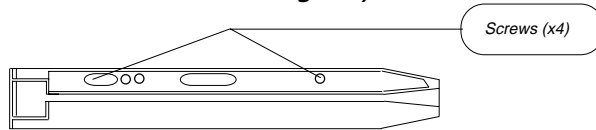

- Replace the bottom. (Before installation, read the following note.)
- Install the entire case and disk in the D-160 following the steps on page "40" (don't forget to lock the key!) and proceed to formatting.

Formatting a hard disk

After replacing the hard disk cartridge, follow this procedure to format the disk. When you turn the power on to a D-160 that has an unformatted disk, the unit automatically enters the Setup mode "Disk Format?" menu.

- Confirm that the cartridge is locked by the key, and turn on the power to the D-160.

The display will show the initial screen, then change to the following screen:

"IDE" shown in the display indicates that the internal IDE hard disk is undergoing formatting.

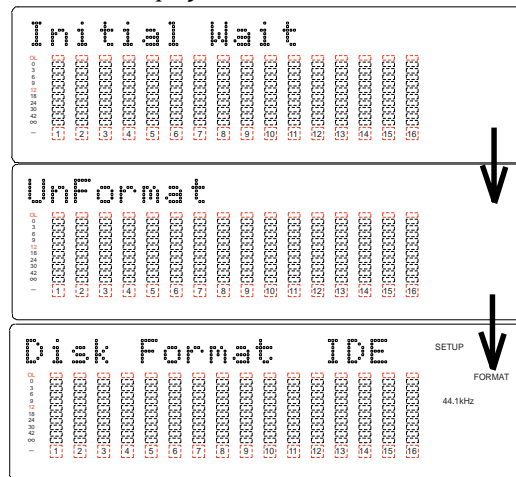

- After confirming the above display, press the EXECUTE/YES key.

The currently installed internal IDE hard disk model name will be shown in the display and "SURE?" will blink at the same time.

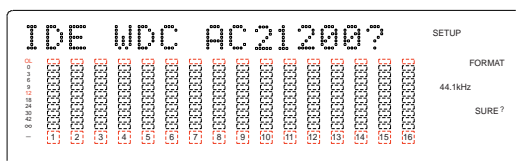

- Press the EXECUTE/YES key again.

Formatting of the internal IDE hard disk will be started and progressive to this, the remaining unformatted disk capacity will be counted down attached with a minus symbol. Simultaneous with the start of formatting, the ∞ symbol FL tube in the level meters of all channels will light. And as formatting progresses, the FL tube will be extinguished one by one starting from track 16.

This is an indication that the hard disk is being formatted correctly and when formatting is finished, all FL tubes will be extinguish and "COMPLETED!" will be lit.

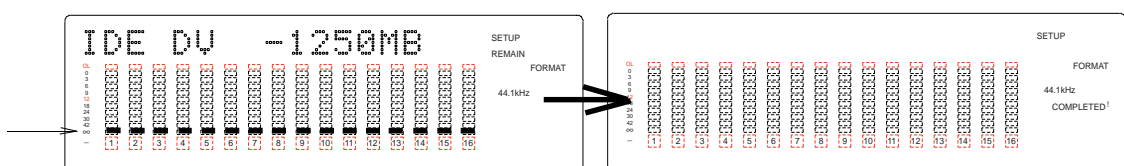

- Press the EXIT/NO key or the STOP button to quit Setup mode.

* If you are using a hard disk that already contains any data from when it was used in a computer, the D-160 may not enter formatting mode automatically. In this case, press the DISP SEL key to force the unit to enter Setup mode, and then select "Disk Format?" to format the disk. (See page "171" for more information on "Disk Format?" menu in the Setup mode.)

8. Extending the detachable controller

You can remove the detachable controller from the main unit and extend it using an optional Model 8551 extension cable.

This optional cable is five meters long, and is equipped with D-sub 15-pin male and female connectors.

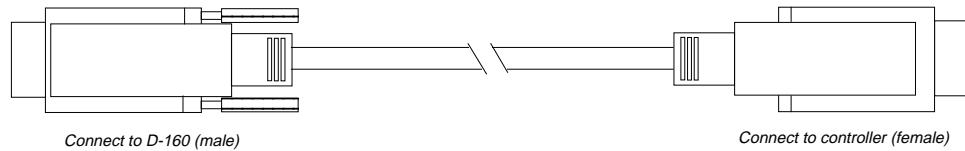

1. Turn the power off to the D-160 before connecting the cable.
2. Loosen the screw for the connector that connects the controller to the D-160, and remove the connector.
3. Remove the controller from the D-160.

Pull the controller toward you while pushing it up with your hand to remove it easily.

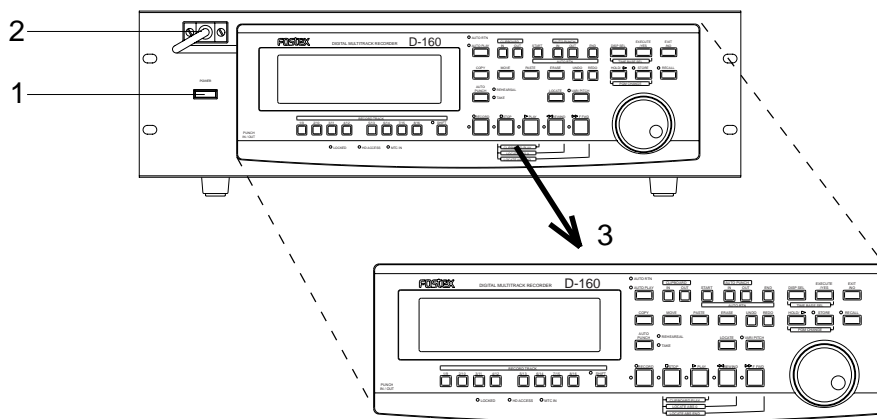

4. Insert the male connector of the extension cable to the D-160's connector, and secure it with a screw.
5. Connect the female connector on the cable and the male connector on the controller cable, and secure them with a screw.

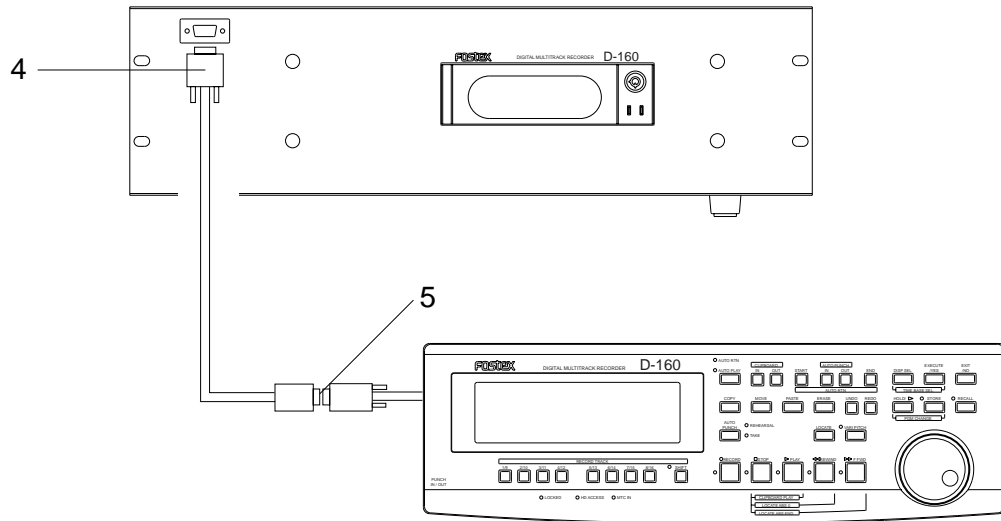

6. Turn the power on to the D-160, and operate the buttons and keys on the controller to confirm that the D-160 operates correctly.

<WARNING>

When you use the detachable controller remotely using an extension cable, the D-160 may malfunction due to electromagnetic interference. In this case, turn the power off, then on to the D-160 to restore it to normal.

Fostex is not responsible for any malfunction of the D-160 that is caused by electromagnetic interference.

<CAUTION>

Turn off the D-160 before connecting or disconnecting any cables.

Connecting or disconnecting the footswitch or detachable controller cables while the D-160 is turned on will cause it to malfunction.

Recording / Playback

This section explains how to record and playback data on the D-160.

1. Basic connections

The D-160 is a 16-track recorder, equipped with analog INPUTs 1-8 and OUTPUTs 1-16. Refer to the following diagram to connect the D-160 to an external mixing console or multitrack recording.

The optimum mixing console for the D-160 would be equipped with 16 TAPE IN connectors and 8 BUSS OUT connectors (or GROUP OUT connectors), although you can also use a mixer with 16 TAPE IN connectors and 4 BUSS OUT connectors. Refer to the following examples depending on the type of your mixer.

<Example-1>

Connecting a mixer equipped with 16 TAPE IN, 8 BUSS OUT (or GROUP OUT):

This connection allows for 8-track simultaneous recording.

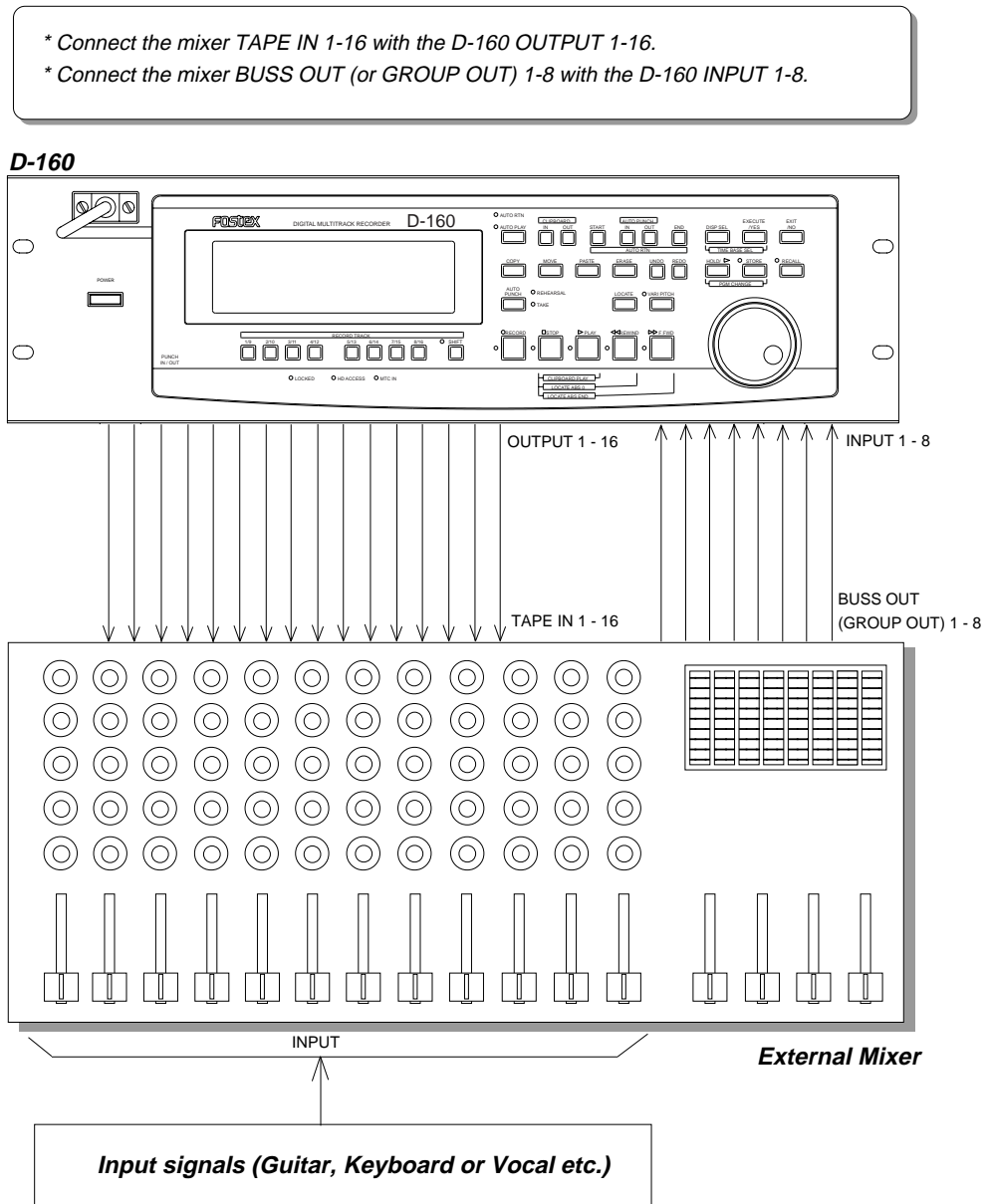

<Example-2>

Connecting a mixer equipped with 16 TAPE IN, 4 BUSS OUT (or GROUP OUT):

In this example, you would record tracks 1-4 first, then tracks 5-8, 9-12 or 13-16.

- * Connect the mixer TAPE IN 1-16 with the D-160 OUTPUT 1-16.
- * Connect the mixer BUSS OUT (or GROUP OUT) 1-4 with the D-160 INPUT 1-4 to record tracks 1-4. To record tracks 5-8 and 13-16, connect INPUT 5-8 instead of INPUT 1-4. (Using a patch bay allows you to change the connection from the front.)

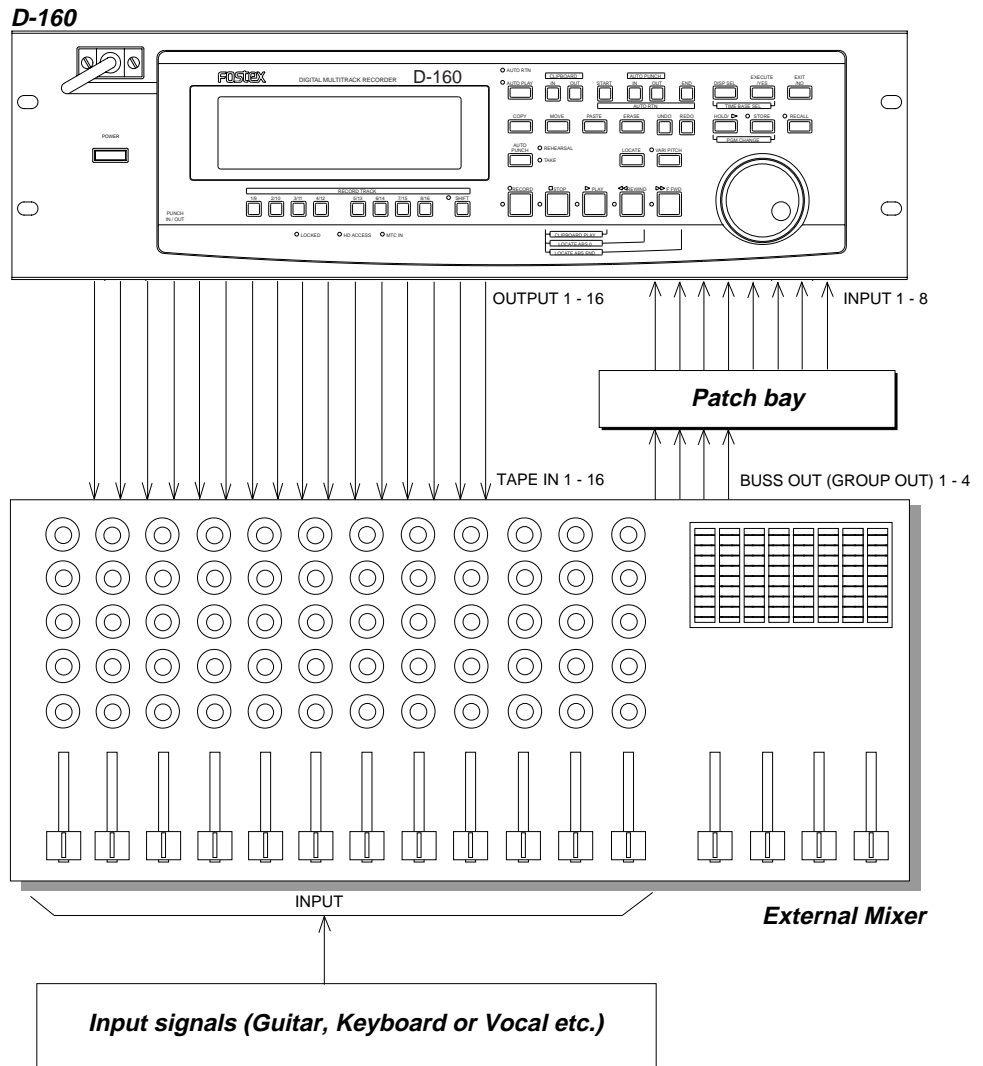

2. Default setting on the D-160

Before you start operating the D-160 or proceed to the next step, you may want to arrange the controls and switches to restore the initial setting so that you will not, for example, erase important data on a track by using incorrect settings. In this manual, this procedure is called "setting defaults." For default settings, the controls and switches should be arranged as shown in the figure below. Make it a rule to return to these default settings before you proceed to a new step.

* "FORMAT FIRST". You need to format the internal hard disk prior to start recording if a brand new hard disk drive has been installed. Refer to the explanation of the "Disk Format?" menu in the Setup mode. We recommend that you format the hard disk as often as possible before you start fresh recording on it. However, remember that the format process will erase all of the recorded song data.

Outline of the Initial Settings:

- * Turn all the RECORD TRACK select keys to "SAFE." (Track indication is turned off.)
- * Auto Return/Auto Play mode is "OFF." (The AUTO RTN/AUTO PLAY LEDs are off.)
- * Auto Punch mode is "OFF." (The REHEARSAL/TAKE LEDs are off.)
- * The STOP button LED is lit.
- * The STORE key and the RECALL keys are "OFF." (The STORE/RECALL LEDs are off.)
- * "Rec Protect?" is "Off" selected in Setup mode.
- * "Digi. In?" is assigned to "L: - -, R: - -" in Setup mode.
- * "Slave Mode?" is "Off" selected in Setup mode.
- * Setting a Program for recording/playback (See 2-1, 2-2, 2-3.)
- * Setting a sampling rate for recording/playback (See 2-4.)
- * Turning off the Vari-pitch function. (The LED is turned off.)
- * The LED of the SHIFT key is off.

When the Recording Enabled/Disabled parameter in the Setup mode is set to "DISABLE rEc," pressing the RECORD button and the PLAY button will not start recording, and the unit will display "DISABLE rEc" on the panel. Be sure to set the mode to "EnABLE rEc" to enable the recording function.

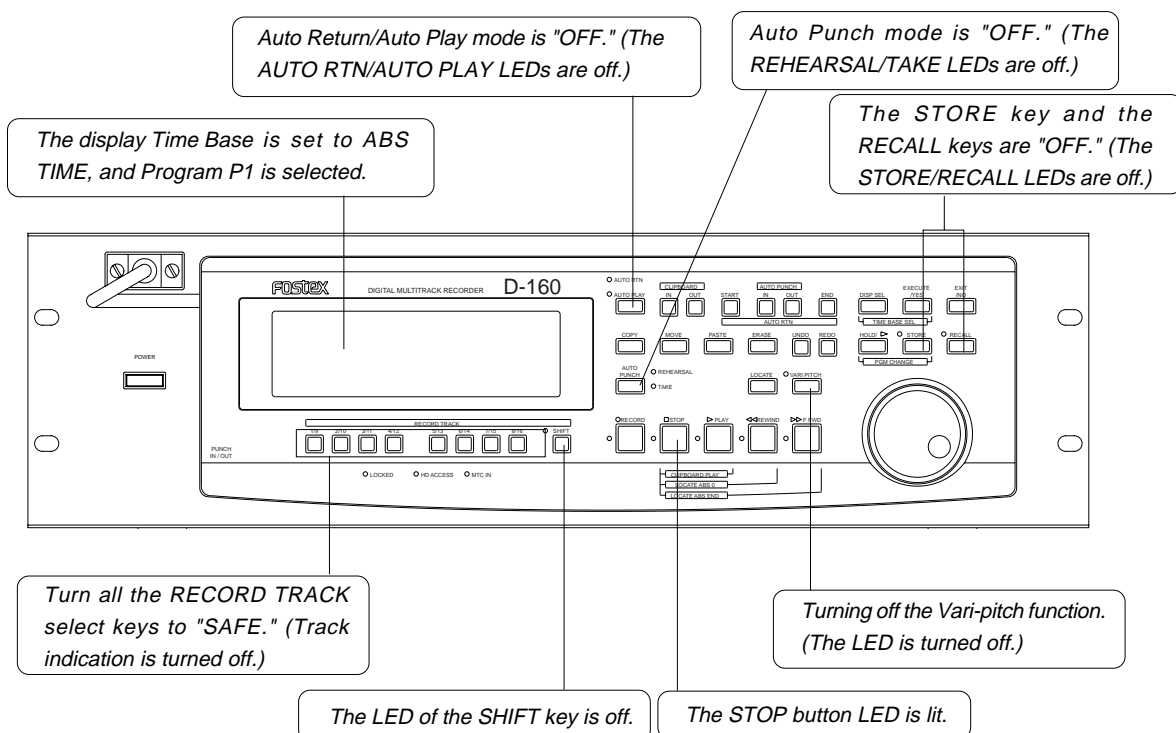

2-1. Setting a Program

As explained in the "Before Operating the D-160," the D-160 features a Program Change function that enables you to manage up to 99 individual Programs. This means that you need to select a desired Program to work on before you start recording or playing back.

When you format the hard disk, the D-160 offers one Program (P01) as a default setting. Follow the procedure below to setup new Programs (up to 99) to manage each Program using various operations, including the Program Change function.

Program setup procedure

1. Press the STORE key while holding down the HOLD/> key.

The D-160 will enter Program setup mode. The "Select PGM!" indication will appear, and then the current Program number ("01" by default) will flash.

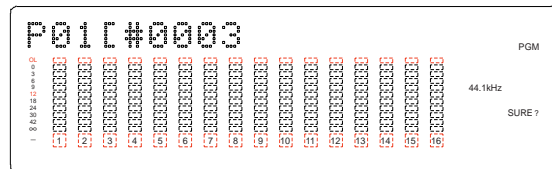
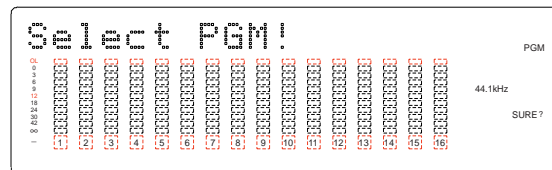
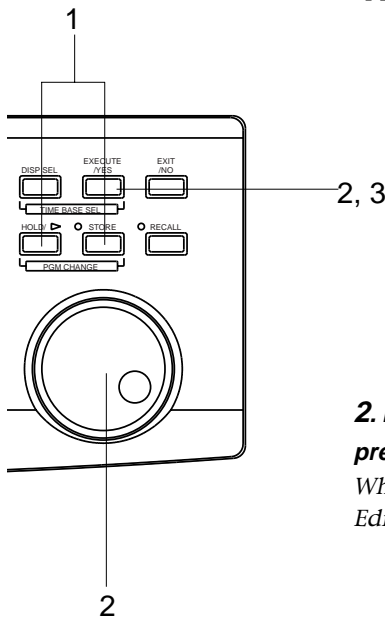

2. Rotate the JOG dial clockwise. When "New Program?" appears ("?" flashes), press the EXECUTE/YES key.

When a new Program (P02 in this example) is setup, the D-160 enters the "Title Edit" menu in Setup mode. The following indication will appear.

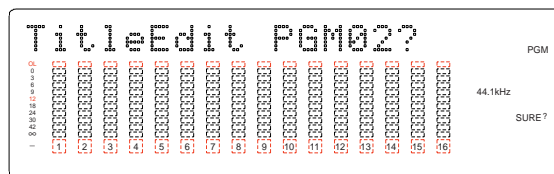
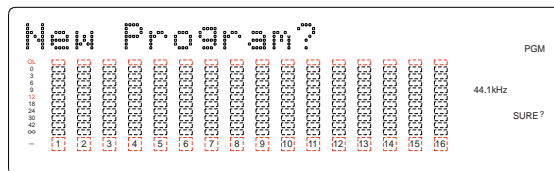

3. Press the EXECUTE/YES key. A default (temporary) name for Program 2 (P02) appears and "#" flashes to the left of the title.

If you wish to use a temporary name as it is, press the EXECUTE/YES key to setup the Program.

If you wish to change the title, refer to page "147" for an explanation of the "Title Edit?" menu in Setup mode. You can also change the title later.

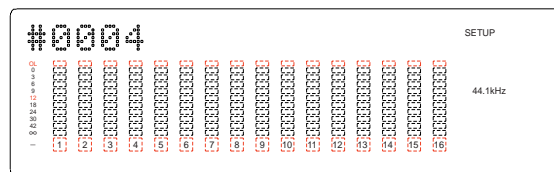

Repeat the procedure described above to setup as many Programs as you need (up to 99). Each time you setup a new Program, the Program will be assigned the subsequent Program number. For example, if you setup a new Program after you have set five Programs (P01~P05), the new Program number will be 6. You cannot skip numbers.

2-2. Program Change

The Program Change function allows you to manage multiple Programs that were setup according to the procedure mentioned above for the recording, playback, or editing of the individual Programs. The D-160 needs to be in the Program Setup mode to perform the Program Change function.

The following example assumes that ten Programs (P01 - P10) have already been setup.

Program Change procedure

1. Press the STORE key while holding down the HOLD/> key.

The D-160 will enter the Program Setup mode, and displays “Select PGM!”, and then the current Program number and title.

2. Use the JOG dial to select a desired Program.

Rotating the JOG dial back and forth will change the Program number on the display to a smaller or larger number.

For example, rotating the JOG dial counter-clockwise when P03 is selected will change the Program number on the display as follows: P03 --> P02 --> P01. Rotating the JOG dial clockwise will change the Program number as follows: P03 --> P04 --> P05 --> P10 --> New Program?.

If you wish to setup a new Program, select the “New Program?” indication.

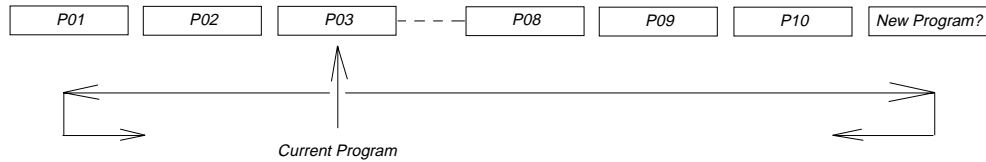

A selected Program uses the Time Base (ABS, MTC, or BAR/BEAT/CLK) that was used for the Program previously. To change the Time Base, press the DISP SEL key while holding down the EXECUTE/YES key. You can set the Time Base for each Program. Pressing the DISP SEL key will display the REMAIN indication. Use this indication to check to see if any available recording time (or bars) remains. This remaining time is not the time for the corresponding Program, but the total amount of time that can be used by all Programs. Bear in mind that the REMAIN indication is based on the mono track calculation.

<Note>

1. The following parameters can be set for each Program individually:
 Memory data (CLIPBOARD IN/OUT, AUTO RTN START/END, AUTO PUNCH IN/OUT)
 Time Base (ABS, MTC, or BAR/BEAT/CLK)
 SETUP mode:
 * Time signature setting (BAR BEAT), * TEMPO setting, * CLICK ON/OFF setting,
 * PREROLL TIME setting, * MIDI SYNC OUT setting, * MTC FRAME RATE setting,
 * MTC OFFSET setting, * MTC OFFSET MODE setting, * REC PROTECT ON/OFF setting,
 * SLAVE MODE ON/OFF setting, * SLAVE TYPE setting, * FS (Sampling frequency) setting

2. The following parameters are common to all Programs:
 Auto Play mode ON/OFF, Auto Return mode ON/OFF, Vari-pitch mode ON/OFF, Pitch data
 SETUP mode:
 * DIGITAL IN setting, * DIGITAL OUT setting, * BAR/BEAT RESOLUTION ON/OFF setting,
 * DEVICE ID setting

<Note>

The total available time for recording data in the existing Programs (up to 99) equals the available recording time on the hard disk.

For example, if you are using an optional Model 9041 (1.3GB removable hard disk cartridge), you can record about 15 minutes (with a sampling rate of 44.1kHz) to all 16 tracks. Therefore, if you have already recorded 5-minute, 16-track song in Program 1, the available recording time for other Programs would be about 10 minutes. In other words, regardless of the number of Programs used, you can record up to 15 minutes in total.

Bear in mind that the REMAIN indication is based on a mono track.

2-3. Deleting a Program

You may delete an unnecessary Program using the "Delete PGM?" menu in Setup mode. You can delete a Program that is currently selected with the Program Change function. Follow the procedure below:

Program delete procedure**1. Select a Program to delete with the Program Change function.**

Refer to the "2-2. Program Change function" section.

**2. Press the DISP SEL key to enter Setup mode, and use the JOG dial to select the 'Delete PGM?' menu.****3. Press the EXECUTE/YES key twice to execute the delete operation.**

Refer to page "147" for more information on the "Delete PGM?" menu in Setup mode.

<Note>

After a Program is deleted, the D-160 will display the current Time Base (ABS/BAR BEAT/MTC) of another Program that now has the number of the deleted Program.

This is because Program number are automatically updated.

For example, if you delete Program 5 out of Programs 1-10, Program 6 will become Program 5, and the subsequent Program numbers will be updated. The titles are also updated. (That is, Program 6 now becomes Program 5, with the title for Program 5, and the subsequent Program titles are updated.)

2-4. Setting a Sampling Rate

The D-160 supports two sampling rates: 44.1kHz and 48kHz.

Before you start recording data in a new Program, be sure to set the sampling rate, using the procedure below. After you format the disk or set up a new Program, the sampling rate is set to "44.1kHz." If you wish to use this rate, you do not have to follow the procedure below.

The sampling rate of the Program is indicated by the status of the 48kHz message above the display. The message lights up at a setting of 48kHz, and is turned off at a setting of 44.1kHz.

- * Default: 44.1kHz
- * Available sampling rates: 44.1kHz, 48kHz
- * This parameter can be set for each Program.
- * This setting can be saved and loaded as part of the song data.
- * This setting will be retained after the power is turned off.

- * Check to make sure the correct Program has been selected before you set the sampling rate.

* Refer to page "162" of " Setup mode 2-19. Sampling Frequency Setting" for information on operating procedures.

The sampling rate setting does not greatly affect analog recording or playback. However, it can be an important element when the D-160 is processing a digital signal. For example, CDs use a sampling rate of 44.1kHz, and you will need to set the sampling rate of the D-160 to 44.1kHz for digital recording from a CD. If you have set the sampling rate on the D-160 to 48kHz when recording from a CD, the 48kHz message located above the display will flash to warn you. When you work with a 48kHz digital signal input from an adat, set the sampling rate to 48kHz.

Also, make sure that the sampling rate of any external device matches that of the D-160 when a digital signal is output from the D-160 to an external device, such as a digital mixer.

<Note>

A 48kHz sampling rate setting requires more disk space than a 44.1kHz setting. This means that the available recording time will be shorter. Therefore, the remaining disk space (REMAIN) after recording with a sampling rate of 48kHz would be smaller (shorter in time).

<Note>

Do not change the sampling rate of a Program during a session unless it is very important. It is possible to change the sampling rate setting, but the Program will be played back at a speed different from the original recording speed, causing the data value stored in the Memory keys (time, or bar/beat/clock) to change.

* Refer to page "60" for information on recording and playback of a digital signal.

3. Analog Recording and Playback

This explanation is based on the assumption that the D-160 is connected to a mixer, and the sound source is input from the mixer's BUSS OUT (GROUP OUT) connector, as shown in the "1. Basic Connection" section.

* Restore the default settings on the D-160.

* Check the Program selection and the sampling rate setting. Do not change these settings until this session is complete.

3-1. Basic recording and playback

Assume that "P01" has been selected for recording.

If you wish to record data in another Program, see the section 3-2.

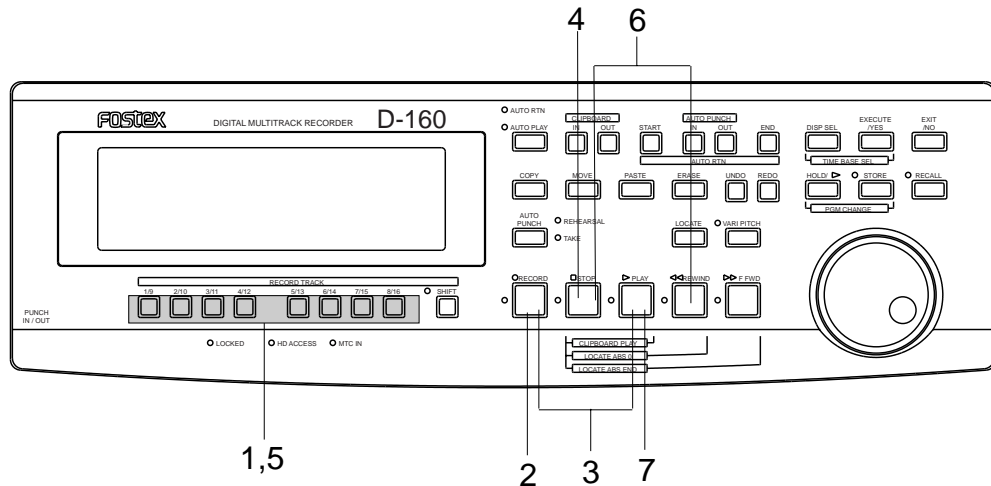

Turn on the power to the D-160, and check to make sure that the Time Base display indicates ABS time "00m 00s 00f" and "P01".

Selecting a recording track

1. Press any RECORD TRACK select key (1-16) to "READY" the track.

The number of the selected track will blink on the display.

Adjusting the recording level

The D-160 does not have a recording level control. You need to adjust the recording level on a connected device that sends out sound data. Primarily use the GROUP OUT master faders (or the faders that control the output level of BUSS OUT 1-16) on the mixer. The recording track of the D-160 also needs to enter input monitoring status.

2. Press the RECORD button once.

The READY track enters input monitoring status. Raise the GROUP OUT master fader on the mixer so that the meter of the "READY" track approaches level "0-3" at peak volume. If the "OL" indication is lit, the recording level is too high.

Unlike an analog recorder, if the recording level is too high, the signal may be distorted on a digital recorder. In particular, recording vocal or acoustic musical instruments requires more attention because the recording level may change suddenly, causing signal overflow. It may be a good idea to use a compressor/limiter connected to an INSERT connector on the mixer.

Start recording

3. After adjusting the recording level, press the RECORD button while holding down the PLAY button.

The blinking RECORD LED and track indicator will light up.

4. To stop recording, press the STOP button.

"Please Wait!" will be shown in the display while the post recording process is in progress.

Playback

5. Press the "READY" track's RECORD TRACK select key to switch to "SAFE." (The track indicator will turn off.)

6. Press the STOP button and the REWIND button simultaneously to locate the beginning of the Program (ABS 0).

7. Press the PLAY button.

The recorder will start playback data. Adjust the TAPE IN input level on the mixer while monitoring.

In this way, you can record sound source to any track (a single track or multiple tracks).

3-2. Recording with the Program Change function (Switching Programs P01-P99)

As previously explained, the D-160 has a "Program Change Function" to manage up to ninety-nine songs. You can record, playback, and edit each Program separately. This section explains how to record and play back Programs using the Program Change function.

* Restore the default settings on the D-160.

Changing a Program

1. Set the Program to be recorded.

Select the desired Program by referring to the previous "2-2. Program Change."

When you select a Program, the Time Base setting (ABS, MTC, or BAR/BEAT/CLK) you used previously for that Program will be used again.

To change the Time Base display, Press the DISP SEL key while holding down the EXECUTE/YES key. You can set the Time Base for each Program individually.

You can also switch to the REMAIN indication by pressing the DISP SEL key.

Check to see if there is enough time (bars) remaining for recording.

This value is not an available time for each Program, but the total available time for all Programs.

2. Set the sampling rate if necessary.

Refer to section "2-4. Setting a sampling rate" for the correct procedure.

Recording (Refer to "3-1. Basic recording/playback" for details.)

3. Press the RECORD TRACK select key (1-16) to set the recording track in ready mode.

4. Press the RECORD button once to set the unit in input monitoring status, and adjust the recording level.

5. Press the RECORD button while holding down the PLAY button.

6. When recording is complete, press the STOP button.

"Please Wait!" will be shown in the display while the post recording process is in progress.

Playback (Refer to "3-1. Basic recording/playback" for details.)

- 7. Press the RECORD TRACK select key for the track in ready mode so that the track becomes "safe."**

The track LED will be turned off.

- 8. Press the REWIND button while holding down the STOP button to locate the top of the Program (ABS 0) (LOCATE ABS 0).**

- 9. Press the PLAY button.**

Playback will start. Adjust the TAPE IN input level from the mixer.

<Note>

The maximum total recording time of all nine Programs equals the available recording time of the hard disk. For example, if you use the optional Model 9041 (1.3GB removable hard disk cartridge), the available recording time is about 15 minutes (with a sampling rate of 44.1kHz, 16 tracks recording). If you have recorded 5 minutes of data in Program 1, you can record 10 minutes for the total time of another Programs. That is, you can record data totalling 15 minutes, regardless of whether you use up all Programs or you record only one Program. Therefore, the remaining recording time is obtained by subtracting the sum of the recorded time for all recorded Programs from the initial total available time.

This remaining time is indicated as the REMAIN time when you press the DISP SEL key. Be sure to watch this time when you are recording multiple Programs.

<Note>

Data with a sampling rate of 48kHz uses more hard disk space than data with a sampling rate of 44.1kHz. Therefore, the available recording time is shorter for 48kHz data.

* Refer to "2-1. Setting a Program" and "2-2. Program Change" for more information on Programs.

* Refer to "2-4. Setting a sampling rate" for more information on sampling rates.

3-3. Playback using the Vari-pitch function

This section describes how to use the Vari-pitch function to change the playback speed of the recorder. The D-160's Vari-pitch function allows for pitch control in the range of +/-6.0% in 0.1% steps.

Use the VARI PITCH key to switch the Vari-pitch function on/off. The LED lights up when the function is enabled, and the LED is off when the function is disabled.

* Restore the default settings on the D-160.

* Check the Program selection and the sampling rate setting. Do not change these settings until this session is complete.

* Assume that a Program has already recorded track according to the procedure described in "3-1. Basic Recording and playback."

1. Press the PLAY button to start playback.

2. Press the VARI PITCH key.

The LED will light up, indicating that the Vari-pitch function is on.

3. Press the RECALL key, and then the VARI PITCH key. ("% indicator will blink.)

The current pitch data will be indicated on the display. You can now edit the pitch data.

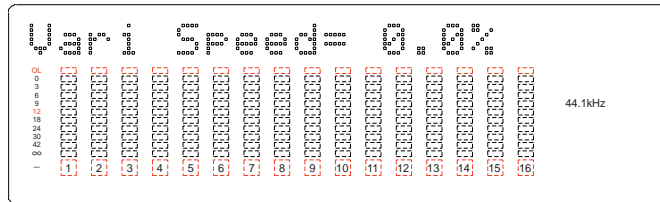

4. Use the JOG dial to edit the pitch data.

You will notice a change in the playback speed.

5. Press the EXECUTE/YES key, the EXIT/NO key, or the STOP button to quit the pitch data screen.

The screen will return to the Time Base display.

You can turn the Vari-pitch function on and off and change the pitch data while the D-160 is playing back or stopped, but not while it is recording.

If the Vari-pitch function is on and the pitch data is set before recording starts, that speed will be used during recording.

While the pitch data is shown on the display, you can turn the function on and off and edit the pitch data. However, the PLAY button, or the combination of the PLAY button and the RECORD button, will be disabled. If you wish to change the pitch while you are listening to the sound, first press the PLAY button to start playback, and then display the pitch data indication to change the speed.

<Note>

When you press the VARI PITCH key, the VARI PITCH LED will light, even if the pitch data is set to 0.0%. The LED indicates that the Vari-pitch function is turned on.

<Note>

The Vari-pitch function will automatically turned off under the following conditions:

- * When you turn off the power to the unit. (The pitch data will be reset to 0.0%.)
- * When you set the Slave mode to On. (The Vari-pitch function will retain the pitch data.)
- * When you set up a digital input track and the DIGITAL indication on the display lights up. (The Vari-pitch function will retain the pitch data.)
- * If you have installed an optional Model 8345 TC/SYNC card on the D-160 and you have set the "Word Out?" menu in Setup mode to "8345," the Vari-pitch function is turned on even during digital input via DIGITAL IN.

* Refer to page "123" for more information on Slave mode.

* Refer to page "60" for more information on digital signals.

3-4. Multitrack recording using overdubbing

You have mastered basic recording/playback in the previous section.

In this section, we will make a multitrack recording.

Multitrack recording is a series of operations in which you record sound sources to multiple tracks and combine these recordings into two mixes (L, R). In this process, the most important step is "overdubbing." "Overdubbing" means recording a new sound source to another track using input monitoring, while listening to the playback of the pre-recorded sound (that is, playback monitoring).

The following is an example of an overdubbing procedure:

Step 1: Record a drum machine to Track 1

Step 2: Overdub an electric bass to Track 2 while listening to Track 1

Step 3: Overdub an electric lead guitar on Track 3 while listening to Track 1 and 2

Step 4: Overdub an electric side guitar on Track 4 while listening to Track 1, 2 and 3

In this way, we will overdub sound sources to Track 1 through 16 as shown in the diagram below.

| Track 1 | Track 2 | Track 3 | Track 4 | | Track 14 | Track 15 | Track 16 |
|--------------|---------|-----------|-----------|-------|----------|----------|----------|
| Drum Machine | E. Bass | E. Guitar | E. Guitar | | Vocal 2 | Piano | Synth. |

* Restore the default setting on the D-160.

* Stay in the same Program until you finish overdubbing.

* Check the Program selection and the sampling rate setting. Do not change these settings until this session is complete.

Selecting a recording track

1. Press the RECORD TRACK select key of an overdub track to "READY" the track.

For example, if you are overdubbing Track 2 while listening to Track 1, set the RECORD TRACK select key "2" to "READY." (Number "2" will blink.)

Adjusting the recording level (rehearsal)

2. Press the RECORD button once. (The RECORD LED will blink.)

The "READY" track will enter input monitoring mode, and "SAFE" tracks will enter playback monitoring mode.

3. Press the PLAY button to play back data from the beginning of the program (ABS 0).

Adjust the playback monitoring level of the "SAFE" tracks, and play a musical instrument while adjusting the GROUP OUT level on the mixer, that is, a recording level on the recorder.

4. Rewind data to the beginning of the disk by Pressing the STOP button and the REWIND button simultaneously.

Start overdubbing

5. Press the RECORD button while holding down the PLAY button.

Recording will start, and the RECORD LED and the "READY" track indicator will light.

6. Play the instrument while listening to the playback as you did during rehearsal.

7. When recording is complete, stop the recorder, and locate the beginning of the data.

Playback

8. To prevent accidental recording, switch the RECORD TRACK select key of the "READY" track to "SAFE."

9. Press the PLAY button to start playing back the recording.

On the mixing console, adjust the playback monitoring level of the already recorded tracks and newly recorded track.

Repeat the steps described above to overdub Tracks 1 through 16.

3-5. Mixdown

Mixdown is the final step in multitrack recording and allows you to combine multiple track recordings to L and R channels (two mixes), and copy the data to a master recorder. The mixdown signal is output from the mixer STEREO OUT L/R connector. Connect the Inputs of the master recorder to the STEREO OUT L/R.

- * Set the D-160 to the default setting.
- * This manual assumes that you have already recorded sound sources to all sixteen tracks.
- * Refer to the mixer instruction manual for applying effects.
- * Connect the master recorder to the mixer STEREO OUT L/R as shown in the diagram.

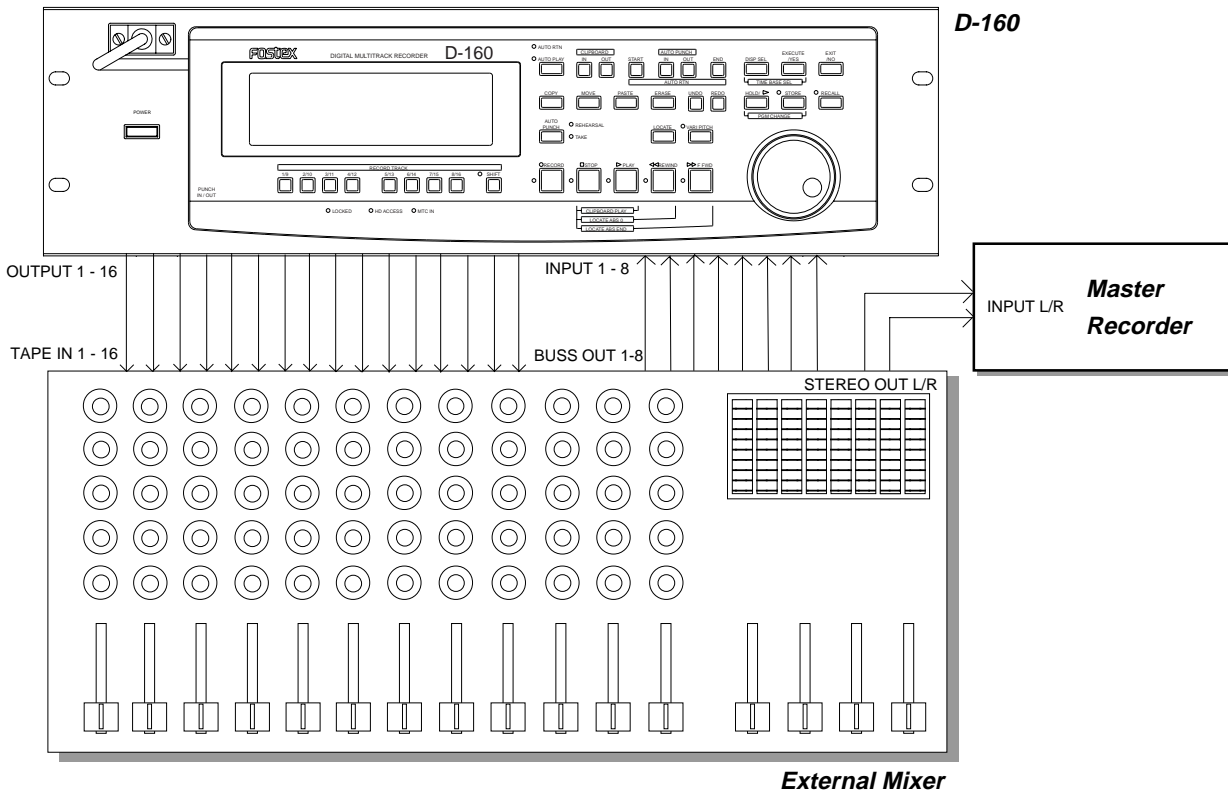

Mixdown rehearsal

1. Confirm that all the RECORD TRACK select keys are set to "SAFE."
2. Locate the beginning of the sound data on the recorder. (Press the STOP button and the REWIND button simultaneously.)
3. Set the master recorder to REC-STANDBY mode.
4. Press the PLAY button on the D-160 to play back recordings, adjust the tonal quality and mix balance of the playback sound on the mixer channels, and adjust the recording level on the master recorder.
Adjust the input level of the master recorder so that the mixer STEREO OUT L/R meters and the level meters of the master recorder move in the same manner.
5. Locate the beginning of the program (ABS 0).

Mixdown

6. Start recording on the master recorder.
7. Press the PLAY button on the D-160 to start playback.
8. When mixdown is complete, press the STOP button to stop the D-160.
Stop the master recorder, and listen to the mixdown song.

3-6. Ping-pong recording

This section explains how to perform ping-pong recording.

Ping-pong recording enables you to combine multiple recorded tracks and copy them to an empty track. You can then overdub additional sounds onto the previously-recorded tracks, adding instrumentation or musical parts to your recording.

- * In this example, we are going to ping-pong Tracks 1 through 6 to Tracks 9 and 10. Since effects cannot be applied to each sound individually after ping-pong recording, we need to apply effects here on the mixer and record the effect sound to Tracks 9 and 10.
- * Set the D-160 to the default setting.
- * Check the Program selection and the sampling rate setting. Do not change these settings until this session is complete.

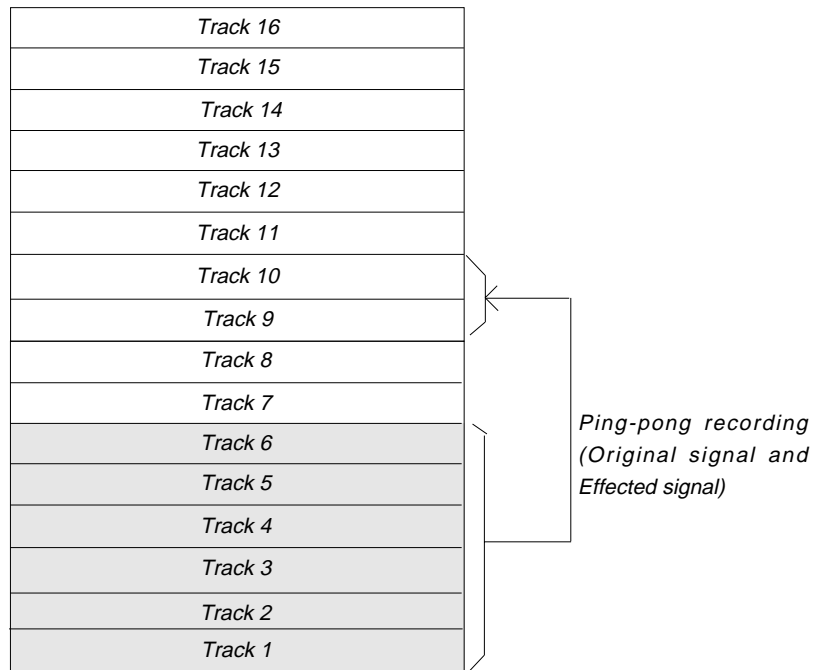

Selecting a recording track

1. Press the RECORD TRACK select keys 9 and 10 to "READY" Tracks 9 and 10.

Level adjustment/Rehearsal

2. Press the RECORD button once. (The RECORD LED will blink.)
Tracks 9 and 10 enter input monitoring status.
3. Press the PLAY button to start playback.
Use the mixer to send the signal in Tracks 1-6 to Tracks 9 and 10 and adjust the recording level.
4. After rehearsal is complete, locate the beginning of the program (ABS 0).

Actual ping-pong recording

5. Press the RECORD button while pressing and holding down the PLAY button to start ping-pong recording.

4. Digital Recording

4-1. Digital recording from an external digital device

This section explains how to record a digital signal from the digital output of an external digital device (CD, MD, DAT, Fostex RD-8, CX-8, etc.) to the D-160.

* Restore the default settings on the D-160.

Connecting an external digital device

Connect the DATA INPUT connector of the D-160 with the digital output of an external digital device (CD, MD, DAT, Fostex RD-8, CX-8, etc.).

<Note>

The D-160 switches the DATA INPUT connector between an S/P DIF digital signal (OPTICAL) and an adat digital signal during setting of the digital input track in Setup mode. Both signals use the same connector configuration, but carry different data. When S/P DIF digital signals are to be input, DATA INPUT 1-8 only should be used, and when "adat" digital signals are to be input, either DATA INPUT 1-8 or 9-16 must be used.

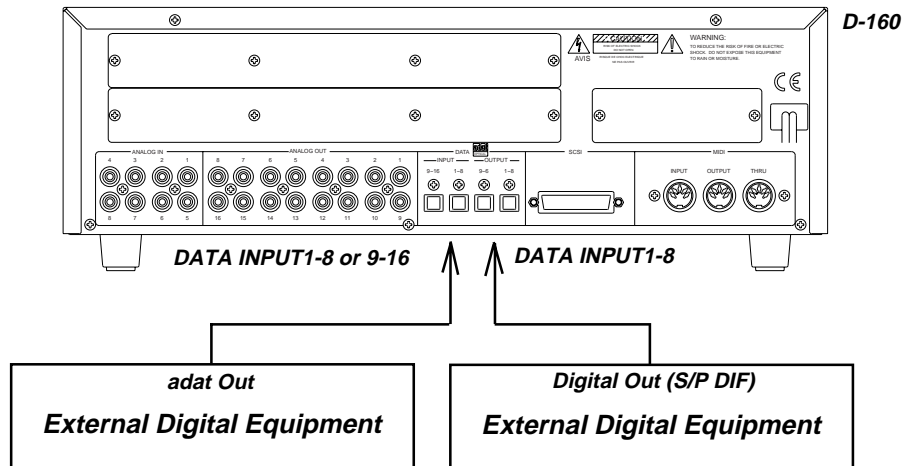

<Notes at input of adat digital signals>

As shown in schematic below, if "adat" digital signals are simultaneously input from two individual "adat" equipment, it will be the cause of noise. Therefore, at input of "adat" digital signals, be sure that the 16 channel output from the same equipment or the two "adat" outputs from perfectly word locked two separate equipment, are input. If both "adat" (DATA INPUT 1-8 or 9-16) are connected, phase will be synchronized at each press of the STOP button to compensate for phase drift. Also, during this period, DATA INPUT 9-16 will be muted for about 0.5 seconds.

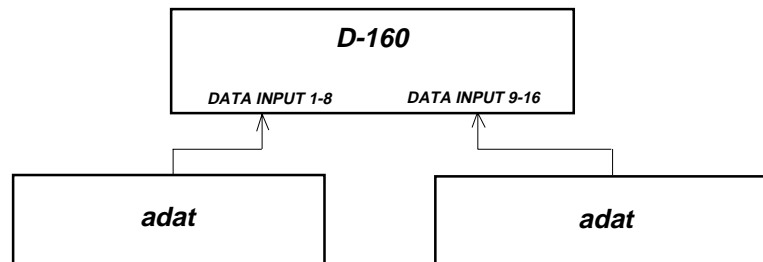

- * If the external device has only a coaxial (RCA) type digital output connector, use the optional COP-1 optical/coaxial converter to connect the device to transmit an S/P DIF digital signal. The operation is the same as that for a device with a coaxial connector.
- * If you connect both the digital input and output of the D-160 to those of an external digital device, a digital loop may be generated. Refer to "4-3. Connecting a digital mixer" for more information.

Setting an external device

Set the external device so that it will output digital signals from the digital output connector. Some devices may output digital signals only when they are in playback mode.

* Refer to the instruction manual that came with the external device for details.

Selecting a recording Program

Selecting the recording Program.

Refer to "2-2. Program Change" section for more information.

* Refer to "2-1. Setting a Program" , " 2-2. Program Change" and "2-3. Deleting a Program" for more information on Programs.

Setting the sampling rate for a recording Program

*******IMPORTANT*******

When an S/P DIF digital signal is input to the D-160, be sure to match the sampling rate of the D-160 to that of the external digital device.

* If the sampling rate settings do not match, you cannot record the S/P DIF digital signal.

* For an adat digital signal, the D-160 will be able to record data with a different sampling rate setting. However, the data will be recorded at a different speed. The D-160 will lock to the external word clock when S/P DIF or adat digital signals are input to the digital input tracks. (The D-160 will operate, referencing to the word clock sent from the external device.) However, an adat digital signal does not contain the sampling rate information (48kHz or 44.1kHz) that is included in the S/P DIF digital signal. This is why the D-160 can sync to the external device with a different sampling rate.

* Initial setting: 44.1kHz

* Sampling rate settings: 44.1kHz, 48kHz

* This parameter can be set for each Program.

* The setting can be saved and loaded as part of the song data.

* This setting will be retained after you turn off the power.

* Refer to "2-4. Setting a sampling rate" on page "52" for information on how to set the sampling rate of the selected Program.

After setting the sampling rate, press the DISP SEL key to display the REMAIN indication and check the remaining time available for recording.

If there is not enough time for recording, try to increase the time by using the Erase function to move the ABS END point of another Program forward, or by saving the song data of Programs that are not often used to a DAT machine to clear that data from the unit.

<Note>

A 48kHz sampling rate setting requires more disk space than the 44.1kHz setting. This means that the available recording time would be shorter.

* Refer to page "96" for more information on the Erase function.

* Refer to page "102" for more information on saving song data.

Setting up a digital input track

Set the input tracks according to the type of digital signal selected in "Digi. In ?" menu in Setup mode. In the following setup items, Lch=1~16 and Rch=1~16 are inputs of S/P DIF digital signals and will be input only from DATA INPUT 1-8. At input of "adat" digital signals, signals from DATA INPUT 1-8 and DATA INPUT 9-16 will be respectively input to ch1~8 and ch9~16.

- * Initial setting: L - - R - - (No assignment for both L and R)
- * Options: Lch = 1~16, adat, - - (no assignment), Rch = 1~16, - - (no assignment)
- * This parameter is common to all Programs.
- * This parameter setting cannot be saved or loaded as part of the song data.
- * This parameter settings will be retained after the power is turned off.

* Refer to "2-15. Digital input track setting" on page "157" for more information on the procedure and details.

<Note>

- * Tracks assigned for digital input will accept only a digital signal, not an analog signal. When this system is to be used with the digital input track set to "adat", because an analog signal can be input to the data track not connected, a digital 8 track and analog 8 track can be simultaneously recorded. For example, if DATA INPUT 1-8 are used and DATA INPUT 9-16 are not connected, analog signals can be input in the analog input 9-16 connector.
- * This setting will automatically disable the Vari-pitch function (the LED will be turn off).
- * Do not remove the optical cable or perform any other operation that would disconnect the digital signal until the session is complete. Otherwise, the D-160 will generate noise, and affect the connected device.
- * Do not set the input mode to a different setting during input of "adat" digital signals. It could result in abnormal input/output of the digital signals.

Selecting a recording track

Press the RECORD TRACK select key of the recording track to set that track in ready mode.

Recording

1. Press the REWIND button while holding down the STOP button to locate the top of the Program (ABS 0) (LOCATE ABS 0).
2. Confirm that the "DIGITAL" indicator on the display is lit in red, and press the RECORD button while holding down the PLAY button to start recording.
You do not need to adjust the recording level in digital recording.
3. Start playing back on the external digital device.
Check to see if the level meter of the D-160 is moving, responding to the input signal.
4. When recording is completed, stop the D-160 and the external device.

<Note>

If you do not perform further digital recording, set the L and R channel assignments to "- -" (no assignment). This will prevent an interrupted signal or the occurrence of noise due to digital looping.

4-2. Digital recording to an external digital device

This section explains how to record a digital data from the D-160 to an external digital device

* Restore the default settings on the D-160.

Connecting an external digital device

Connect the DATA OUTPUT connector of the D-160 with the digital input of an external digital device.

<Note>

The D-160 switches the DATA OUTPUT connector between the S/P DIF digital signal (OPTICAL) and the adat digital signal during setting of the digital input track in Setup mode. Both signals use the same connector configuration, but carry different data. When S/P DIF digital signals are to be output, DATA OUTPUT 1-8 only should be used, and when "adat" digital signals are to be output, either DATA OUTPUT 1-8 or 9-16 must be used.

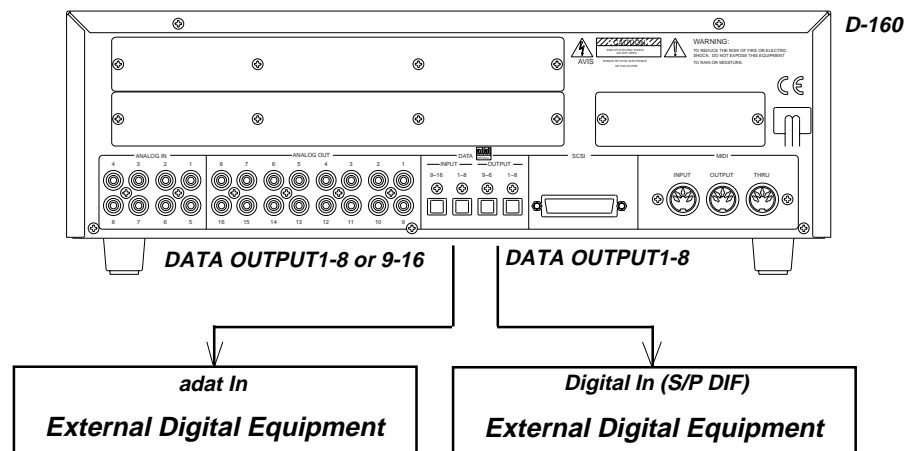

* If the external device has only a coaxial (RCA) type digital output connector, use an optional COP-1 optical/coaxial converter to connect the device to transmit an S/P DIF digital signal. The operation is the same as that for a device with a coaxial connector.

* If you connect both the digital input and output of the D-160 to those of an external digital device, a digital loop might be generated. Refer to "4-3. Connecting a digital mixer" for more information.

Selecting a playback Program

Selecting the playback Program.

Refer to "2-2. Program Change" section for more information.

* Refer to "2-1. Setting a Program", "2-2. Program Change" and "2-3. Deleting a Program" for more information on Programs.

Setting the sampling rate for a playback Program

You need to set the sampling rate of a playback Program to match that of the digital device before recording digital data.

*****IMPORTANT*****

When a digital signal is output from the D-160, be sure to match the sampling rate of the external digital device to that of the D-160. If the sampling rate setting does not match, you cannot record the S/P DIF digital signal and noise may be generated. Refer to "2-4. Setting a sampling rate" for more information on how to check the sampling rate of the selected Program. You can also check the rate via the 48kHz indicator located above the display.

Setting up a digital output track

Set the output tracks according to the type of digital signal selected in "Digi. Out ?" in Setup mode. In the following setup items, Lch=1~16 and Rch=1~16 are outputs of S/P DIF digital signals and will be output only from DATA OUTPUT 1-8.

At output of "adat" digital signals, signals from DATA OUTPUT 1-8 and DATA OUTPUT 9-16 will be respectively output to ch1~8 and ch9~16.

* Refer to "2-16. Digital output track setting in Setup mode" on page "159" for more information on the procedure and details.

* Initial setting: adat

* Options: L ch=adat, ch1~16, R ch= ch1~16

* This parameter is common to all Programs.

* This parameter setting cannot be saved or loaded as part of the song data.

* This parameter settings will be retained after the power is turned off.

* All tracks including tracks specified for digital output also output analog signal.

Setting up an external device

Set the external device so that it will accept a digital signal. On some devices, you may need to set it so that the device will synchronize to the input digital signal.

For example, if you are using a Fostex RD-8, select "DIGITAL IN" for input, and set "Clock Source" (external sync signal) to "Word Optical (adat)."

<Note>

When you are monitoring the digital signal from the external device and a signal cannot be input or digital noise is generated, check the connection, cabling, and settings on the D-160 and the external device.

* Refer to the instruction manual that came with the external digital device for more information.

Recording

1. Press the REWIND button while holding down the STOP button to locate the top of the Program (ABS 0) (LOCATE ABS 0).

2. Start recording on the external device.

You do not need to adjust the recording level in digital recording.

3. Press the PLAY button to start playing back on the D-160.

Check to see if the level meter of the external device is moving, and responding to the input signal.

4. When recording is complete, stop the D-160 and the external device.

<Note>

* Do not remove the optical cable or perform any other operation that would disconnect the digital signal until the session is complete. Otherwise, the D-160 will generate noise, and affect the connected device.

4-3. Connecting a digital mixer

******* About Digital Loop *******

As shown in the figure, connecting the input and output connectors of the D-160 to the output and input of a digital mixer respectively may cause digital looping. When you select a digital input track, the D-160 will automatically enter “sync to the external word clock in digital input signal” mode. If you set the connected digital mixer to the same condition (that is, “sync to the external word clock in digital input signal” mode), both devices will try to lock to the external word clock, resulting in a digital loop that prevents synchronization from being established. To avoid this situation, follow one of the suggestions below, depending on the type of the connected mixer.

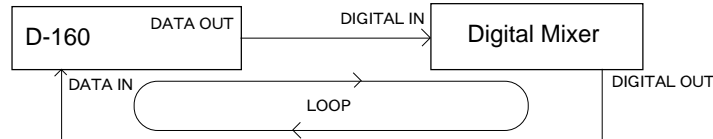

A. Using a digital mixer that accepts a digital signal if you select its internal clock as sync source:
The mixer is always able to input and output a digital signal to and from the D-160. Select an appropriate digital signal to input in the “digital input track” parameter on the D-160. The D-160 will lock to the external word clock.

B. Using a digital mixer that locks to the external clock when you select digital input on the D-160:
You need to change the settings on both devices. If you wish to input a digital signal to the D-160, select an appropriate digital signal to input in the “digital input track” parameter. You cannot select “digital in” on the digital mixer. On the other hand, if you wish to input a digital signal to the digital mixer, select “digital in” on the digital mixer, and set the “digital input track” parameter of the D-160 to “L-- R--” (no assignment).

This section uses a digital mixer as an example, but the same problem applies to any other digital device. Any digital device (DAT, adat, etc.) can replace the digital mixer in this explanation.

The precaution described above applies to a system in which both the input and output of the D-160 are connected to the output and input of the external device respectively. If you connect either one of them (output or input), the device that accepts the input signal will lock and sync to the output device.

The example here uses a digital mixer that can accept a digital input signal when its internal clock (INTERNAL) is selected.

Connecting a digital mixer

Connect the DATA INPUT of the D-160 to the digital output jack of the digital mixer, and the DATA OUTPUT of the D-160 to the digital input jack of the mixer.

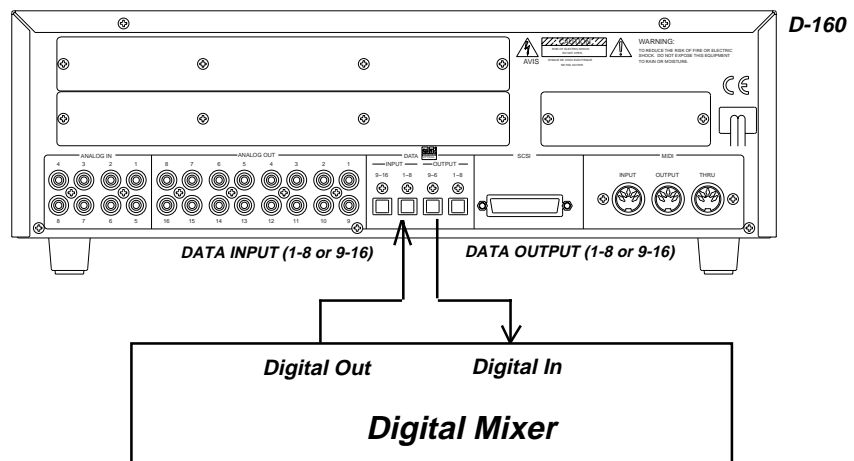

Setting a digital mixer

1. **Select the internal clock (INTERNAL).**
2. **Set the mixer so that it will be able to accept a digital input signal.**

* Refer to the instruction manual that came with the external digital device.

Setting the D-160

1. **Select a Program.**

* Refer to "2-2. Program Change" for the procedure and details.

2. **Set a sampling rate.**

Set the sampling rate of the D-160 to that of the digital mixer.

* Refer to "2-4. Setting a sampling rate" for the procedure and details.

3. **Set the digital input track in Setup mode according to the type of the digital input signal.**

* Refer to "2-15. Digital input track setting in Setup mode" on page "157" for the procedure and details.

4. **Set the digital output signal in the digital output track parameter in Setup mode.**

* Refer to "2-16. Digital output track setting in Setup mode" on page "159" for the procedure and details.

<Note>

When you set up a digital input track, the settings for the external sync signal of the "Slave mode type setting" in Setup mode (that is, Vari, S/P DIF, adat, and Free) will be ignored, and the D-160 will sync to the specified digital input signal. Refer to "2-13. Slave mode type setting" in Setup mode on page "155" for more information.

Locate Function

The D-160 can immediately locate to any desired point .

That is, it can move the current time or function position of the recorder.

Available locate points are: memory data points (time or bar/beat/clock) stored in the Memory keys (CLIPBOARD IN/OUT, AUTO PUNCH IN/OUT, AUTO RTN START/END, and LOCATE keys), the beginning of a Program (ABS 0), and the end of a recording (ABS END).

The D-160 is also equipped with an Auto function, which operates as an extended Locate function, including Auto Play, Auto Return, and Auto Repeat functions.

1. Storing memory data

There are three methods by which you can store memory data: by grabbing a desired time value in real-time when the recorder is playing back or stopped, by editing and storing a desired data, by recalling previously-stored memory data, changing it, and storing it.

These methods can also be used in the Auto Return function, Auto Punch In/Out function, and the edit operations, such as Copy & Paste, Move & Paste, and Erase. Try to become familiar with the methods described here.

Storing memory data in real-time

1. **While the recorder is playing back (or stopped), press the HOLD/> key at the time value (bar/beat/clock) you wish to store.**

The time value of the point at which you pressed the HOLD/> key will be retained, and the D-160 enter the edit mode. "LOCATE" will light on the display.

2. **Press the STORE key. The STORE LED will light.)**

3. **Press the memory key to which you wish to store data.**

The retained time value (bar/beat/clock) will be stored as memory key data, and the Time Base display will be restored. The STORE LED goes off.

* To take a short cut (to skip Step 2), press the STORE key instead of the HOLD/> key in Step 1.

Editing and storing data

1. **While the recorder is playing back (or stopped), press the HOLD/> key at the time value (bar/beat/clock) you wish to store.**

The time value of the point at which you pressed the HOLD/> key will be retained, and the D-160 enter the edit mode. "LOCATE" will light on the display.

2. **Use the HOLD/> key or the SHUTTLE dial to move among the digits of the time (bar/beat/clock), and use the JOG dial to edit them.**

3. **Press the STORE key. The STORE LED will light.**

4. **Press a memory key to which you wish to store data.**

The retained time value (bar/beat/clock) will be stored as memory key data, and the Time Base display will be restored. The STORE LED goes off.

* To take a short cut (to skip Step 3), press the STORE key instead of the HOLD/> key in Step 1.

Recalling, editing, and storing data

- 1. Press a memory key for which you wish to recall data. (Alternatively, press the RECALL key, and then a memory key.)**

The D-160 will display the time value stored in the key (bar/beat/clock) and enter the data edit mode.

- 2. Use the HOLD/> key or the SHUTTLE dial to move among the digits of the time (bar/beat/clock), and use the JOG dial to edit them.**

- 3. Press the STORE key. The STORE LED will light.**

- 4. Press a memory key to which you wish to store data.**

The retained time value (bar/beat/clock) is stored as memory key data, and the Time Base display will be restored. The STORE LED goes off.

You do not necessarily have to store the edited data to the memory key that you pressed to recall the original data. For example, you can press the AUTO PUNCH IN key to recall its memory data, edit it, and store the data to the AUTO PUNCH OUT key.

* Memory data can be stored for each Program (P1-P99) individually.

* Memory data will be saved and loaded as part of the song data in Setup mode.

* Memory data will be retained after you turn off the power.

* Refer to page "50" for information on the Program Change function.

* Refer to page "102" for information on the save and load operation.

<Hints>

If "↓ Resolution?" menu (bar/beat resolution mode) has been turned on in the Setup mode when the "BAR/BEAT/CLK" Time Based is being used, press the HOLD/> key or the STORE key to hold the current bar/beat clock value on the display. You can round off the clock value to "00" (that is, to a bar/beat value).

This function is very useful when you wish to use the memory data in beat steps.

Refer to page "160" for more information on Bar/Beat Resolution ON/OFF menu in Setup mode.

2. Locate

The following table shows how to locate to a data point.

Use the following key sequences to locate a certain point.

In this table, "+" indicates that you need to press the specified key while pressing and holding down the STOP button.

"->" indicates that you need to first press one key, then press a second key.

| | | |
|---|------------------------|--|
| 1 | STOP+REWIND | Locates the beginning of the hard program (ABS 0). |
| 2 | STOP+F FWD | Locates the end of the recorded area on the program (ABS END). |
| 3 | CLIPBOARD IN->LOCATE | Locates the stored Clipboard In point. |
| 4 | CLIPBOARD OUT->LOCATE | Locates the stored Clipboard Out point. |
| 5 | AUTO RTN START->LOCATE | Locates the stored Auto Return Start point. |
| 6 | AUTO RTN END->LOCATE | Locates the stored Auto Return End point. |
| 7 | AUTO PUNCH IN->LOCATE | Locates the stored Auto Punch In point. |
| 8 | AUTO PUNCH OUT->LOCATE | Locates the stored Auto Punch Out point. |
| 9 | LOCATE | Locates the stored Locate point (see the note below). |

Also, follow the procedure below to locate directly to the point of a time value (bar/beat/clock).

1. While the recorder is playing back, press the HOLD/> key at the time value (bar/beat/clock) you wish to store.

The time value of the point at which you pressed the HOLD/> key is retained, and the D-160 enter the edit mode. "LOCATE" will light on the display.

2. Use the HOLD/> key or the SHUTTLE dial to move among the digits of the time (bar/beat/clock), and use the JOG dial to adjust their value.

3. Press the LOCATE key.

The D-160 will locate the point of the edited time value, and the Time Base indication will be restored. ("LOCATE" lights up on the display.)

<Notes>

* Each time a different Memory location (3-8) is located, the LOCATE key memory will be automatically overwritten by the new time value (bar/beat/clock) of the point that was just located. For example, assume that the LOCATE key has a Memory location of 00h: 05m: 40s: 00f: 00sf. When you locate an AUTO RTN START point of 00h: 03m: 00s: 00f: 00sf. If you do not perform a different locate operation, the LOCATE key memory will not change and will always allow the unit to locate to the same point (bar/beat/clock).

* You can check the LOCATE key memory data by pressing the RECALL key, and then the LOCATE key. You can also edit this data, and store the LOCATE key's own data by pressing the STORE key, and then the LOCATE key.

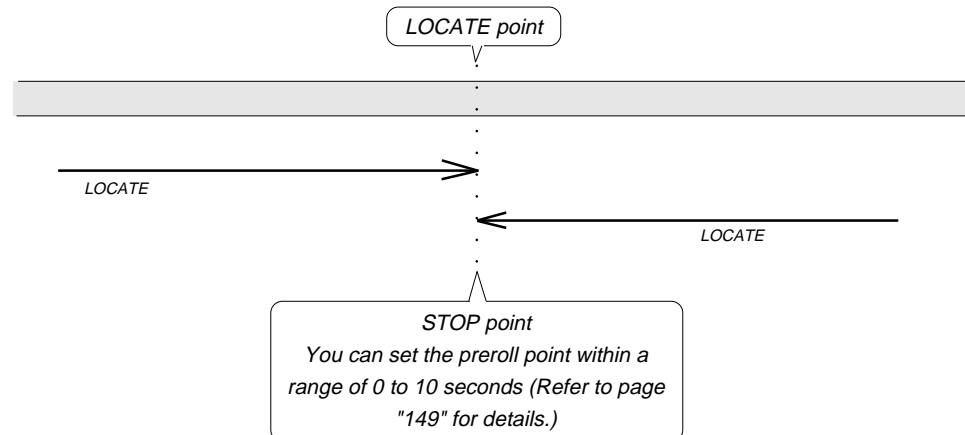

3. Auto Play mode

Turn the Auto Play mode on before using the Direct Locate function, and the D-160 will automatically start playback from the located point.

The diagram below illustrates this operation.

To turn Auto Play mode on, press the AUTO PLAY/AUTO RTN key so that the AUTO PLAY LED will light up. To cancel this mode, press the AUTO PLAY/AUTO RTN key again so that the AUTO PLAY LED will go off.

* Refer to page "15" "Names and Functions" for instructions on using the AUTO PLAY and AUTO RTN keys.

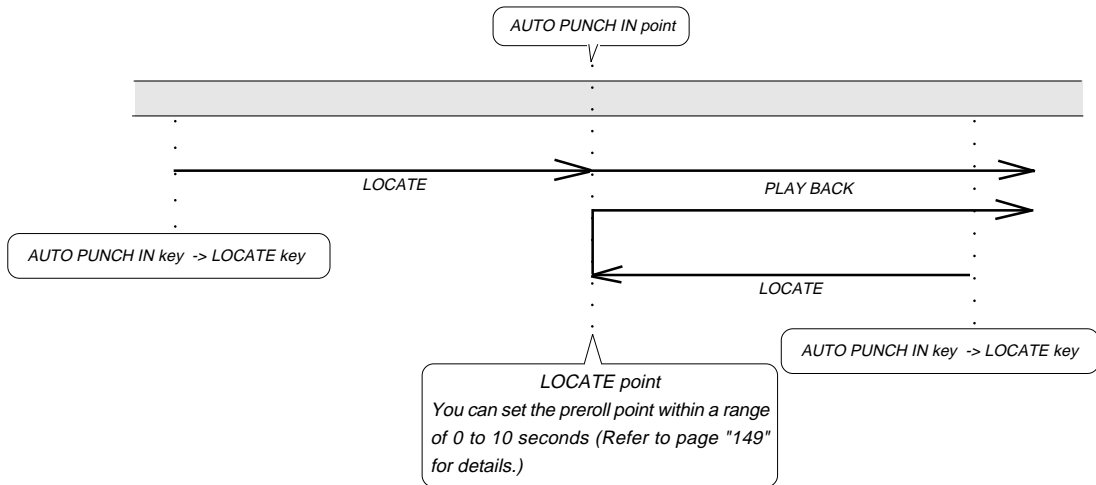

4. Auto Return mode

To turn Auto Return mode on, press the AUTO PLAY/AUTO RTN key so that the AUTO RTN LED will light up.

To use the Auto Return function, first you need to specify the Auto Return Start point and Auto Return End point.

As shown in the diagram below, the D-160 will play back data to the Auto Return End point, then automatically locate the Auto Return Start point, and then stop.

<Note>

The start point will not be located after the AUTO RTN END point is reached when the D-160 is in record mode.

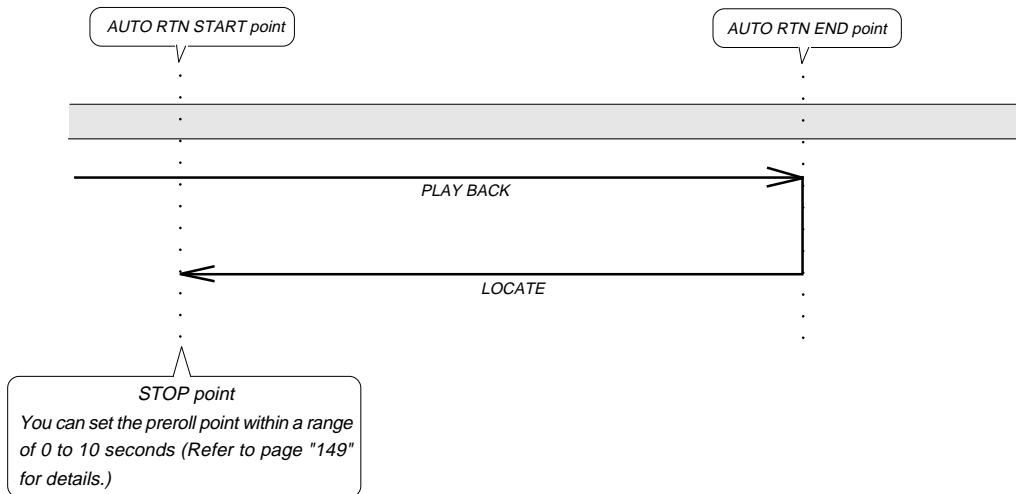

4-1. Setting the Auto Return Start/End point

There are two ways to set the Auto Return Start point and End point: one is to hold and store a desired time value in real-time during playback or while the D-160 is stopped; the other is to edit and store the desired time.

Storing the Start/End point in real-time

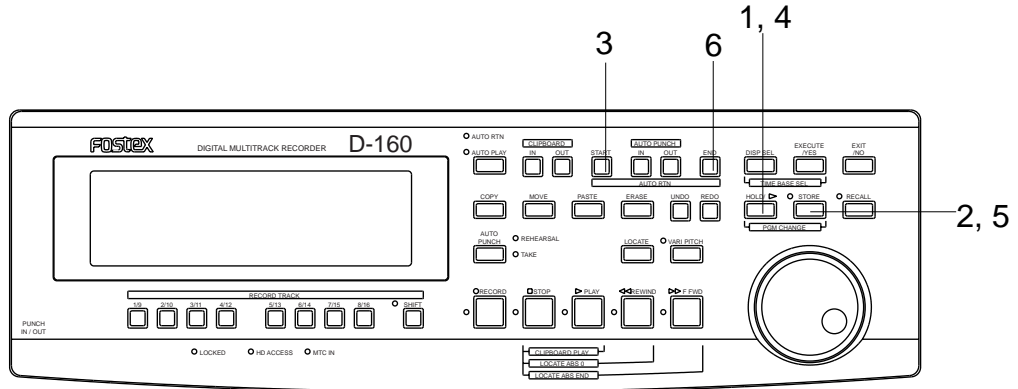

- 1. While the D-160 is playing back or stopped, press the HOLD/>> key at the location you wish to store as the Start point.**

The time value obtained when you press the HOLD/>> key will be held, and the D-160 will enter the edit mode.

* The Bar/Beat Resolution menu setting is available when BAR/BEAT/CLK is used for the Time Base. Refer to page "160" for details.

- 2. Press the STORE key. (The STORE LED will light up.)**

- 3. Press the AUTO RTN START key.**

The time value you held will be stored as the Start point, and the display will go back to the previous screen that was before the time value was held. The STORE LED will go off.

- 4. Press the HOLD/>> key again at the location you wish to store as the End point.**

- 5. Press the STORE key. (The STORE LED will light up.)**

- 6. Press the AUTO RTN END key.**

The time value you held will be stored as the End point, and the display will go back to the previous screen before the time value was held.

* In steps 1 and 4 described above, you can press the STORE key instead of the HOLD/>> key, and then press the AUTO RTN START/AUTO RTN END key to set the data more quickly.

Editing and storing the Start/End point

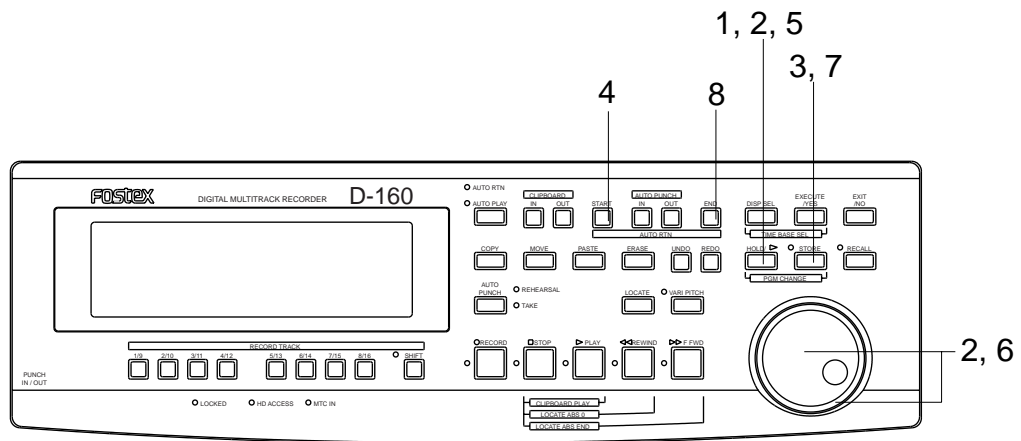

1. Press the HOLD/> key while the D-160 is playing back or stopped.

The time value at the moment when you pressed the HOLD/> key will be held and the unit will enter the edit mode.

* The Bar/Beat Resolution menu setting is available when BAR/BEAT/CLK is used for the Time Base. Refer to page "160" for details.

2. Move the cursor to the time value (bar) using the HOLD/> key or SHUTTLE dial, and use the JOG dial to change the value.

3. Press the STORE key. (The STORE LED will light up.)

4. Press the AUTO RTN START key.

The edited time value will be stored as the Start point, and the display will return to the screen displayed before you held the time value. (The STORE LED will go off.)

5. Press the HOLD/> key again.

6. Enter the value as you did in step 2.

7. Press the STORE key. (The STORE LED will light up.)

8. Press the AUTO RTN END key.

The edited time value will be stored as the End point, and the display will go back to the screen before you held the time value.

* In steps 1 and 5 described above, you can press the STORE key instead of the HOLD/> key, edit the time value (bar), and then press the AUTO RTN START/AUTO RTN END key to set the data more quickly.

Changing the stored Start / End points

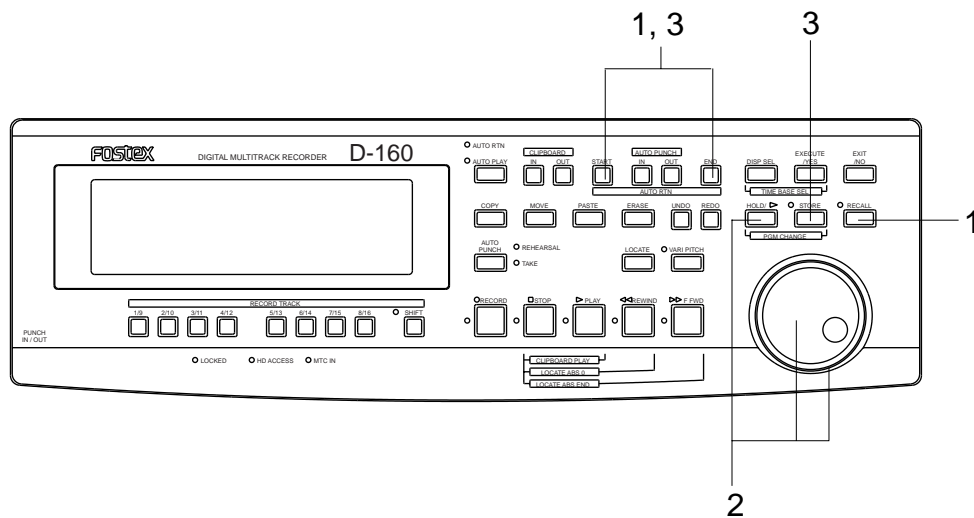

1. Press the **RECALL** key, and then the **AUTO RTN START** key or **AUTO RUN END** key. (As a short-cut, you can press the **AUTO RTN START** key or **AUTO RTN END** key directly.)

The display will show the time value stored at the key, and the unit will enter the edit mode.

2. Move the cursor to the time value (bar) using the **HOLD/>** key or **SHUTTLE** dial, and use the **JOG** dial to change the value.
3. Press the **STORE** key, then press the **AUTO RTN START** key or **AUTO RTN END** key.

The edited time value will be stored as the Start point or End point.

<Note>

Pay attention to the location of the Start and End points. If you have set a larger value to the Start point than the End point while both Auto Return mode and Auto Play mode are on, the D-160 will jump to the Start point and continue to play the rest of the data after playing to the End point (which is located before the Start point).

Therefore, the repeat operation (explained later) will not be carried out correctly). The Auto Return mode is effective only when the unit is in play mode.

<Hints>

If "↓ Resolution?" menu (bar/beat resolution mode) has been turned on in the Setup mode when the "BAR/BEAT/CLK" Time Based is being used, press the **HOLD/>** key or the **STORE** key to hold the current bar/beat clock value on the display, and you can round off the clock value to "00" (that is, to a bar/beat value).

This function is useful when you wish to use the memory data in beat steps.

Refer to page "160" for more information on ↓ Resolution menu in Setup mode.

5. Auto Repeat mode

The Auto Repeat function is a combination of the Auto Play mode and the Auto Return mode. To access the Auto Repeat function, press the AUTO PLAY/AUTO RTN key so that both AUTO RTN LED and AUTO PLAY LED light.

You also need to set the Auto Return Start point and the Auto Return End point, as you did for the Auto Return function. (Refer to the previous section "Auto Return" for information on setting the Start and End points.)

With the Auto Repeat function, the D-160 plays data up to the Auto Return End point, then automatically locates the Auto Return Start point, and plays back data between the Start and End points repeatedly, until you cancel playback using the STOP button.

* Refer to page "15" of "Names and Functions" for instructions on using the AUTO PLAY and AUTO RTN keys.

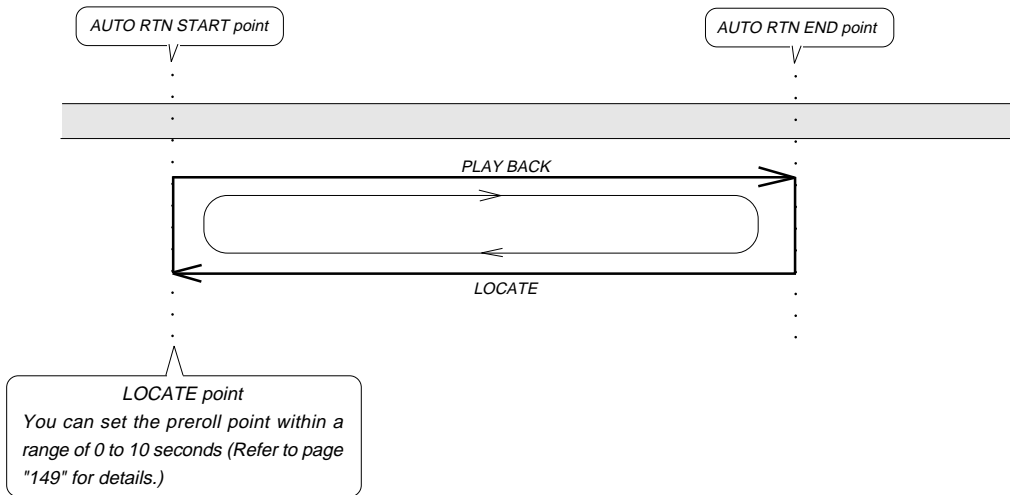

<Hints>

Using the Auto Repeat function when you are rehearsing Auto Punch In/Out recording, allows you to rehearse as many times as you want without tedious operations. For example, by setting the Start point just before the Auto Punch In point and the End point just before the Auto Punch Out point, you do not need to worry about locating the data and can concentrate on rehearsing.

Punch In/Out

Punch In/Out recording is used to re-record data onto a certain area of a pre-recorded track. For example, you can replace a phrase from your guitar solo with a better performance.

There are two ways to Punch In/Out record: Auto Punch In/Out recording, in which you specify the Punch In/Out points; and Manual Punch In/Out recording, in which you use optional foot switch Model 8051.

In either case, the Rehearsal function allows you to practice before the actual take. Using the Punch In/Out recording technique, you can easily and quickly replace mistakes or phrases you do not like with more desirable takes.

Choose one of these methods to suit your preferences and applications.

* The example here explains how to replace "part of the guitar solo" recorded on Track 3 with a new phrase by playing the guitar, while listening to the drum and bass sound recorded on Tracks 1 and 2.

Once you master Punch In/Out recording, you can use this technique for other tracks.

* Assume that the guitar is connected to the mixer input, and that the output signal from the mixer is routed to Track 3 of the D-160.

* Do not change the Program or sampling rate until the session is complete.

* First make sure that the D-160 is set to the default setting.

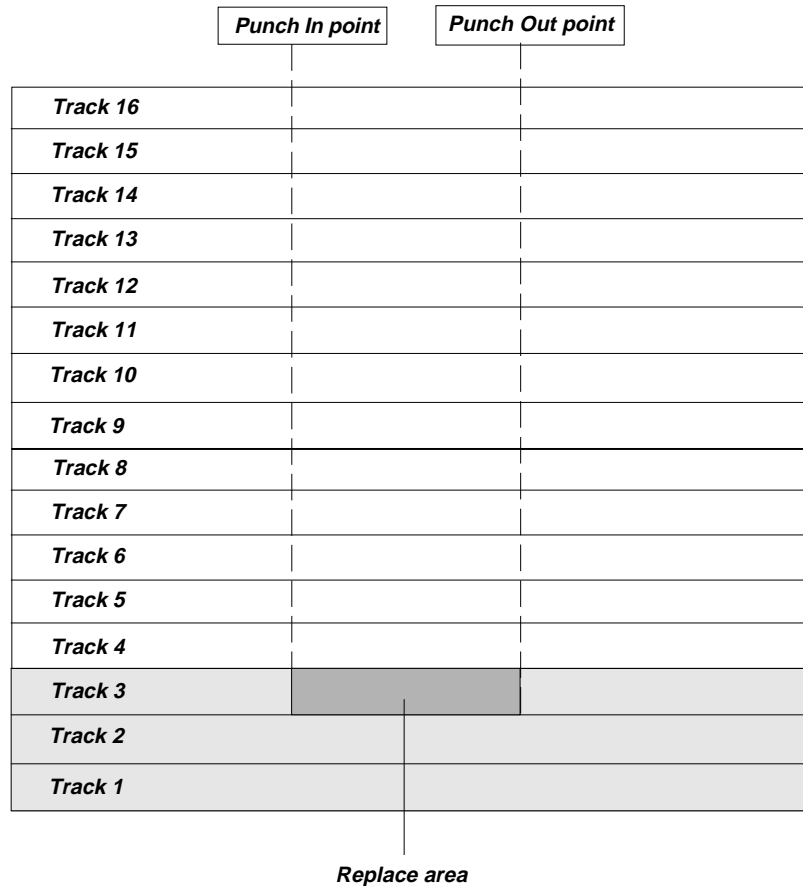

1. Auto Punch In/Out

To perform Auto Punch In/Out recording, first you need to specify the In point (recording start point) and the Out point (recording end point). Once these two points are stored, the D-160 automatically starts recording at the In point and stops recording at the Out point while the recorder is in "Take mode." When you use the Auto Punch In/Out function, you can select "Rehearsal mode" to practice to your satisfaction before you record.

1-1. Storing the Punch In/Punch Out point

Here, we assume that Program 1 with the "ABS" Time Base has been selected. If you wish to choose other Program, press the STORE key while holding down the HOLD/> key.

Storing the Punch In point

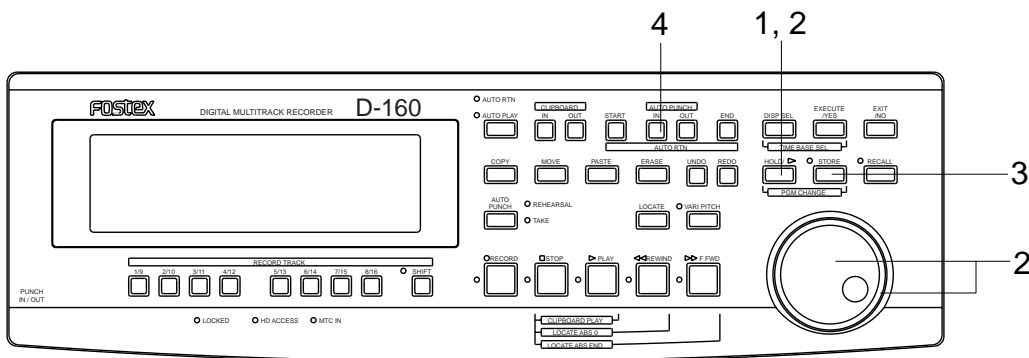

1. Press the HOLD/> key while the recorder is playing back or stopped.

The following example shows that a time of two minutes, 40 seconds, 3 frames, and 28 sub-frames is held, and the Program indication is changed to the sub-frame indication.

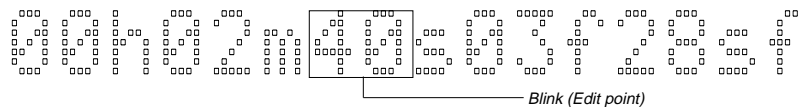

* Pressing the STORE key will enter the D-160 into hold/edit status. In this case, you can omit step 3 below.

2. Press the HOLD/> key or turn the SHUTTLE dial to select the digit you wish to edit, and then use the JOG dial to change the time value.

For example, setup the Auto Punch In point to "3 minutes, 15 seconds, 10 frames".

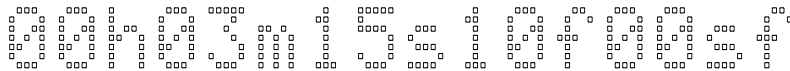

3. Press the STORE key. (The STORE LED will light up.)

4. Press the AUTO PUNCH IN key.

The specified time value will be stored as a Punch In point, and the STORE LED will go off.

Storing the Punch Out point

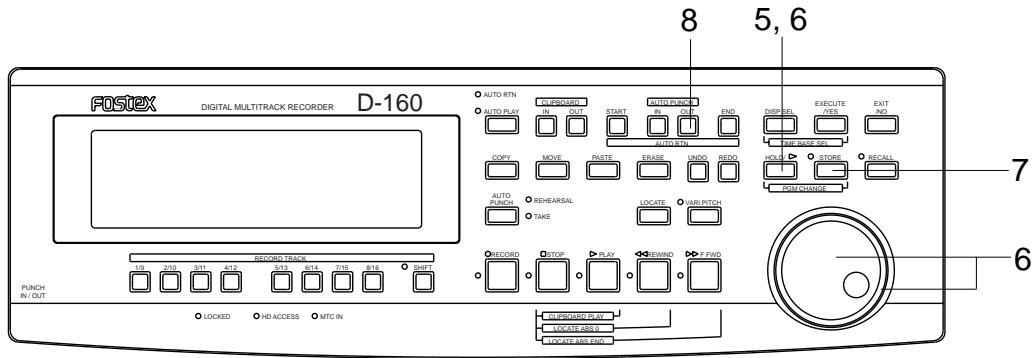

5. Press the **HOLD/>** key to enter edit mode.
6. Press the **HOLD/>** key or turn the **SHUTTLE** dial to select the digit you wish to edit, then use the **JOG** dial to change the time value.
For example, setup the Auto Punch Out point to "3 minutes, 35 seconds, 15 frames".

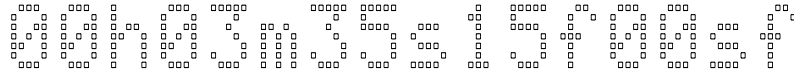

7. Press the **STORE** key. (The **STORE LED** will light up.)
8. Press the **AUTO PUNCH OUT** key.
The specified time value will be stored as a Punch Out point, and the **STORE LED** will go off.

* To check the stored Punch In/Out point, press the **RECALL** key, and then press the **AUTO PUNCH IN** key and/or the **AUTO PUNCH OUT** key. Alternatively, press the **AUTO PUNCH IN/AUTO PUNCH OUT** key. The display will show the stored time value.

<Note>

You cannot set the Punch Out point before the Punch In point location. If the Punch Out point precedes the Punch In point and you try to "punch in," the message "Void Out Point!" appears on the screen immediately after you press the **AUTO PUNCH** key, indicating that the time value of the Punch Out point is inappropriate. Be sure to specify a larger value for the Punch Out point than for the Punch In point.

<Hints>

If "↓ Resolution" menu (Bar/Beat Resolution mode) has been turned on in the Setup mode when the "BAR/BEAT/CLK" Time Based is being used, press the **HOLD/>** key or the **STORE** key to hold the current bar/beat clock value on the display, and you can round off the clock value to "00" (that is, to a bar/beat value). This function is useful when you wish to use the memory data in beat steps.

* Refer to page "*160" for more information on "↓ Resolution" menu in Setup mode.

1-2. Auto Punch In/Out Rehearsal mode

Set the "READY" track into Input monitoring status for the part between the Punch In point and the Punch Out point in Rehearsal mode. (Other tracks are in playback monitoring status.) In Rehearsal mode, nothing is actually recorded. You can repeat rehearsal as many times as you wish adjust the In point, Out point, and recording level.

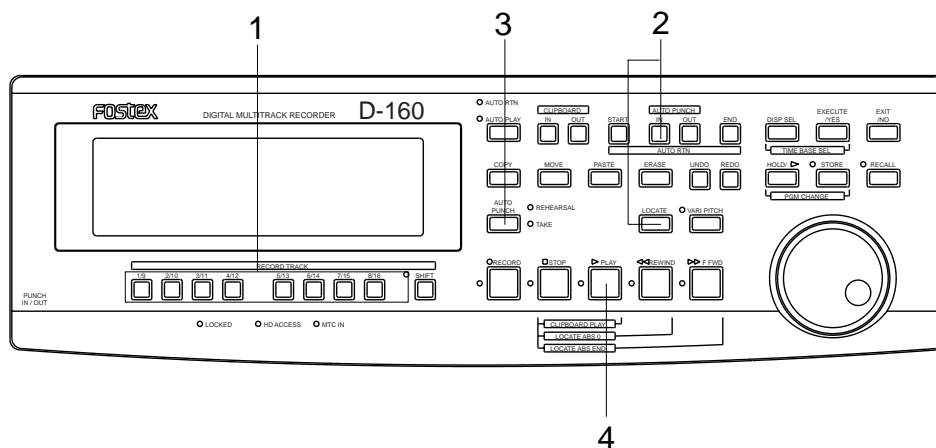

Rehearsal

1. **Press the RECORD TRACK select "3" key to ready Track 3. ("3" on the display will blink.)**
2. **Locate a point just before the Punch In point, using one of the following methods:**
 Press the AUTO PUNCH IN key, then the LOCATE key. (The Auto Punch In point will be located.) Then, press the REWIND button, or turn the SHUTTLE dial counter-clockwise to locate a position slightly ahead. Setting a "Pre-roll" value will make it easier to locate a position the specified number of seconds before the Auto Punch In point.)
 Refer to page "149" for information on the Pre-roll setting function.
 Alternatively, you can store the playback start point (time) at the AUTO RTN START for future locate operations. (You need to use the AUTO RTN START key for Step 4 of "Storing the Punch In point.")
3. **Press the AUTO PUNCH key. (The REHEARSAL and TAKE LEDs will light up.)**
 If the disk does not have enough free space for auto punch in/out, the "Over !" indications appear.
 Refer to "Warning" in the "Display" section in the manual.
4. **Press the PLAY button.**
 Rehearsal mode is engaged as follows on the next page:
5. **Rehearse the guitar part while playing back the drum and bass sounds.**
 You will hear the guitar sound you are playing only between the punch in and punch out points.

| Rehearsal mode (Auto Punch In/Out) | | | |
|---|--|--|--|
| | AUTO PUNCH IN point | AUTO PUNCH OUT point | |
| | <p>All tracks are under REPRO monitoring status.</p> | <p>Only track 3 enters INPUT monitoring status. (However, the D-160 will not record and data in Rehearsal mode.)</p> | <p>All tracks are under REPRO monitoring status.</p> |
| RECORD TRACK display | <div style="border: 1px solid black; padding: 2px; display: inline-block;">3</div> Blink | <div style="border: 1px solid black; padding: 2px; display: inline-block;">3</div> Light up | <div style="border: 1px solid black; padding: 2px; display: inline-block;">3</div> Blink |
| REHEARSAL LED TAKE LED | REHEARSAL LED will light up. | REHEARSAL LED will light up. | REHEARSAL LED will light up |
| PLAY button LED | PLAY LED will light up | PLAY LED will light up RECORD LED will blink | PLAY LED will light up |
| RECORD button LED | | RECORD LED will blink | |

<Hints>

If you are rehearsing over and over, an effective time-saver is to use the Auto Return function along with the Auto Play function.

As shown in the diagram below, specifying the Start and End points for the Auto Return and Auto Play functions allows you to easily rehearse as many times as you like. This enables you to pay more attention to the recording level and your own performance. Refer to pages "71" for more information on setting the Start/End points for the Auto Return/Auto Play functions.

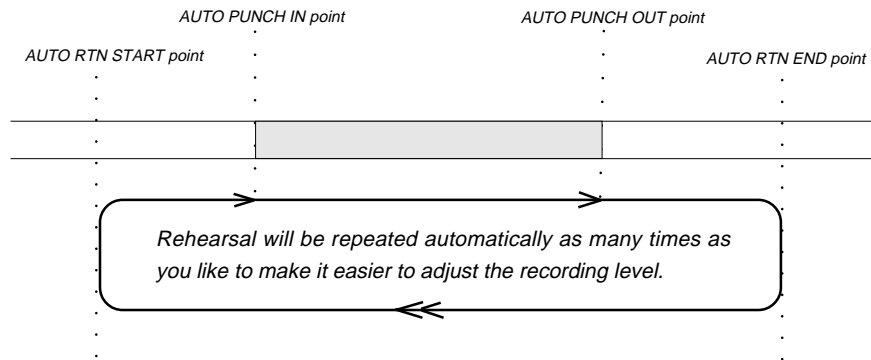





1-3. Auto Punch In/Out Take mode (actual recording)

Proceed to recording after rehearsal.

Take

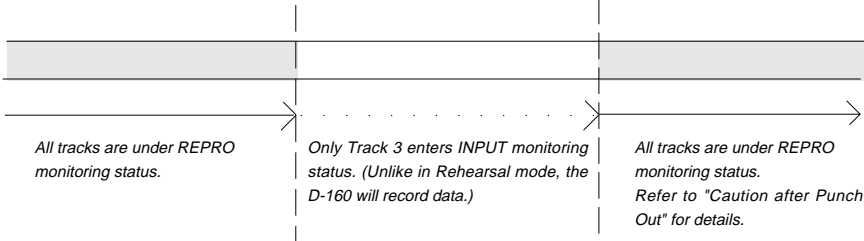
1. **Check to see which tracks are in ready mode.**
Please note that data will be recorded in all tracks set to ready mode.
2. **As in Rehearsal mode, locate the point just before the Punch In point.**
3. **Auto Punch mode is "on".**
4. **Press the RECORD button while pressing and holding down the PLAY button.**
The REHEARSAL LED (green) will go off and the TAKE LED (red) will light up.
5. **Play the guitar while listening to the playback sound.**
As shown in the illustration below, the recorder will start recording automatically at the Punch In point, and stop recording at the Punch Out point.

* When recording is finished, the Auto Punch mode will be canceled, and both REHEARSAL and TAKE LEDs will go off.

| Take mode (Auto Punch In/Out) | AUTO PUNCH IN point | AUTO PUNCH OUT point |
|--|---|--|
|  | <p style="text-align: center;">Only Track 3 enters INPUT monitoring status. (Unlike in Rehearsal mode, the D-160 will record data.)</p> | <p style="text-align: center;">All tracks are under REPRO monitoring status. Refer to "Caution after Punch Out" for details.</p> |
| RECORD TRACK display | <div style="border: 1px solid black; display: inline-block; padding: 2px 5px;">3</div> Blink | <div style="border: 1px solid black; display: inline-block; padding: 2px 5px;">3</div> Light up |
| REHEARSAL LED TAKE LED | TAKE LED will light up | TAKE LED will light up |
| PLAY button LED |  PLAY LED will light up |  PLAY LED will light up |
| RECORD button LED |  RECORD LED will light up |  PLAY LED will light up |

<Caution after Punch Out>

At "Take" of punch out, the punch-in recording track will not immediately enter the repro monitor mode from the input monitor mode but enter the repro monitor mode about two seconds after mute playback. This is a functional feature of D-160 and not a malfunction.

1-4. Undo/Redo of Auto Punch In/Out

* If you press the UNDO key after performing the auto punch in/out operation, the original sound recorded prior to auto punch in/out will be restored.

* If you press the REDO key after undoing the auto punch in/out operation, the auto punch in/out data will be restored.

<Note>

You can use the undo/redo functions while the D-160 is in stop mode. Under the following circumstances, you will be unable to use the undo/redo functions;

1. If you make a new recording,
2. If you make a new edit (copy & paste, move & paste, or erase),
3. If the Auto Punch In point was passed in play or record mode while Auto Punch mode was on, or
4. If you turned off the power to the D-160, then turned it back on.
5. If you use the Program Change function.

2. Punch In/Out Recording using a foot switch

The "Take mode" and "Rehearsal mode" are also available in this application. Pressing the foot switch repeatedly while holding down the STOP button will toggle between "take" and "rehearsal." The REHEARSAL LED of the AUTO PUNCH key will blink during Rehearsal mode, and the LED will turn off during "Take mode."

1. Select the track onto which you wish to punch in/out record.
2. Start playback just before the punch in point.
3. Press the foot switch when you want to start recording.
4. Press the foot switch again when recording is finished.

In this lesson, we are going to replace part of the guitar solo recorded on Track 3, as we did in the Auto Punch In/Out section.

- * Set the D-160 to the default setting.
- * Use an optional foot switch Model 8051 for punch in/out recording.
- * Set Auto Punch mode to OFF. (The REHEARSAL LED and the TAKE LED will be turned off.)
- * Do not change the Program or sampling rate until the session is complete.

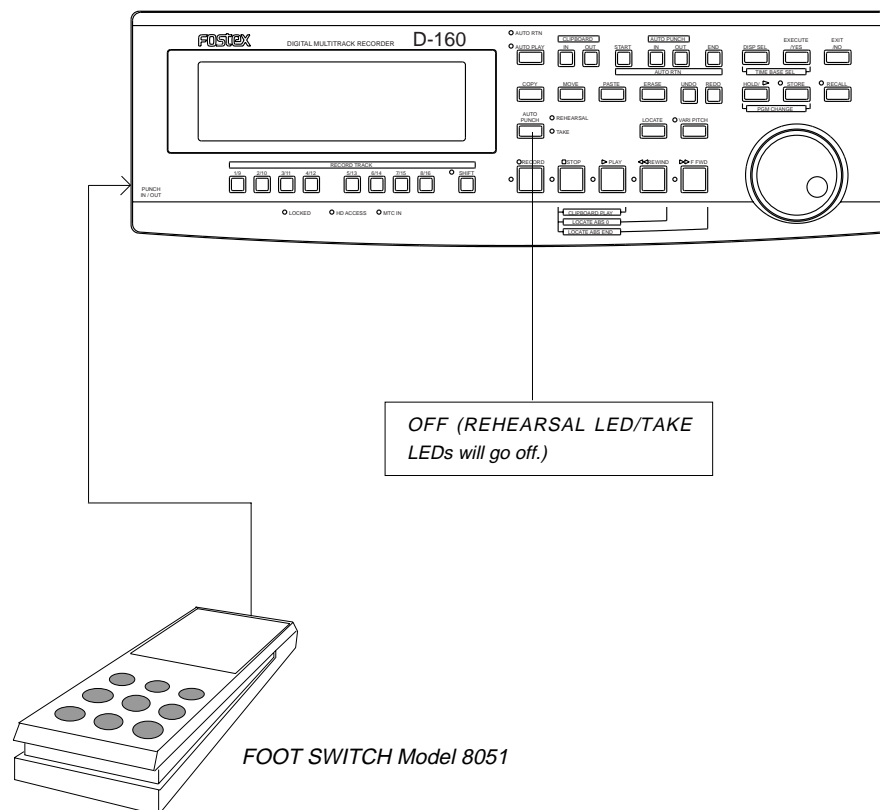

<CAUTION>

Turn off the D-160 before connecting or disconnecting any cables. Connecting or disconnecting the footswitch or detachable controller cables while the D-160 is turned on will cause it to malfunction.

2-1. Punch In/Out Rehearsal (Using a foot switch)

Rehearsal

1. Press the foot switch once while holding down the STOP button.

The D-160 will enter the "Rehearsal" mode, and the 35 dot display on the upper row of the screen will show "Rehearsal On" for one second. Only the REHEARSAL LED (green) will blink.

2. Press the RECORD TRACK select key "3" to set Track 3 to ready mode. (Indicator "3" will flash.)
3. Press the PLAY button at a location just before the punch in point to play back data.
4. Rehearse the guitar part while playing back the drum and bass sounds.
5. Press the foot switch once at the Punch In point, and press the foot switch again at the Punch Out point. The following diagram illustrates this operation. You will hear the guitar sound you are playing only between the punch in and out points.

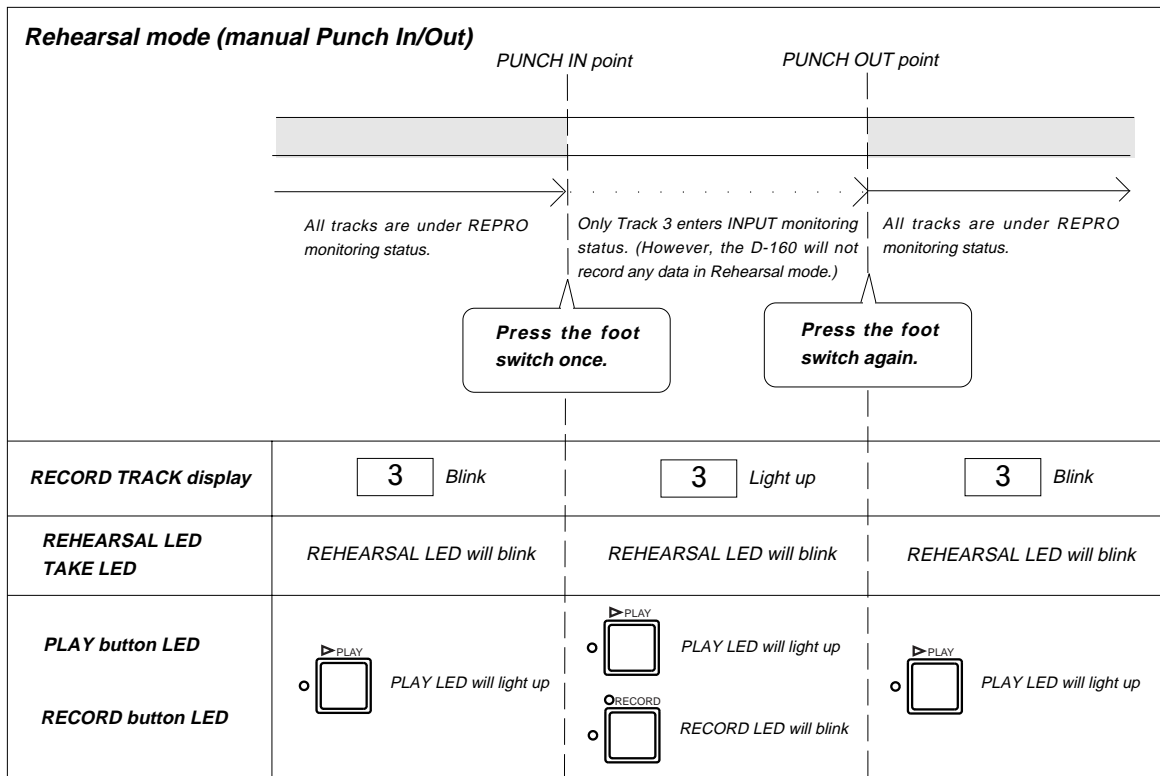

End of rehearsal

1. Press the foot switch again while holding down the STOP button to cancel Rehearsal mode.

The 35 dot display on the upper row of the screen will show "Rehearsal Off" for one second. Also, the REHEARSAL LED (green) will turn off, indicating that you have quit the Rehearsal mode.

<Hints>

When you are rehearsing over and over, an effective time-saver is to use the Auto Return function along with the Auto Play function. As shown in the diagram below, specifying the Start and End points for the Auto Return and Auto Play functions allows you to easily rehearse as many times as you like. In this way, you can pay more attention to the recording level and your own performance. Refer to pages "71" for more information on setting the Start/End points for the Auto Return/Auto Play functions.

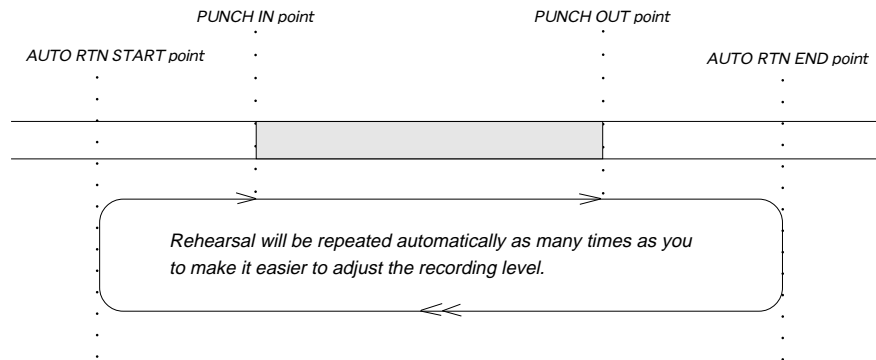

2-2. Punch In/Out Take (manual Punch In/Out)

1. Locate the point just before the punch in point and play back the data.
2. Play the guitar while listening to the playback.
3. Press the foot switch once at the punch in point, and press it again at the punch out point.

When you finish punch out recording, the D-160 will quit recording mode.

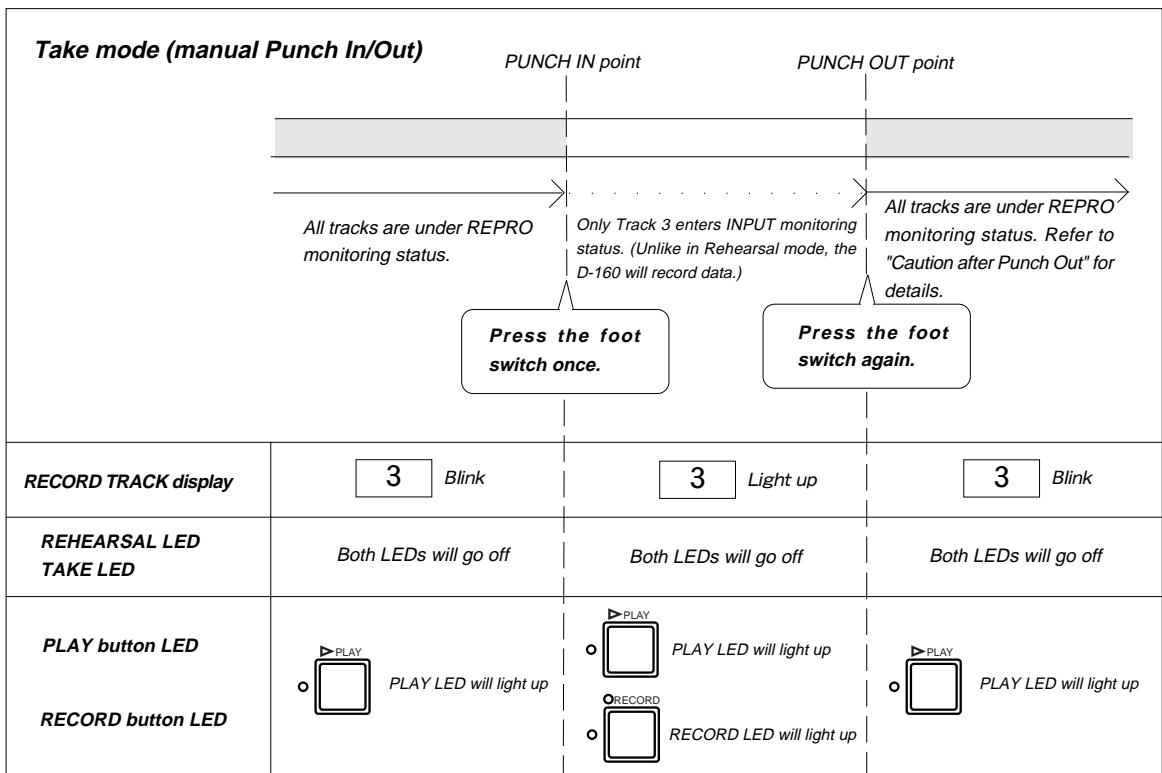

<Caution after Punch Out>

At "Take" of punch out, the punch-in recording track will not immediately enter the repro monitor mode from the input monitor mode but enter the repro monitor mode about two seconds after mute playback.
This is a functional feature of D-160 and not a malfunction.

<Note>

Once you perform Punch In/Out recording using a footswitch, you need to stop the D-160 before performing the next Punch In/Out take.

<Hints>

Besides the foot switch, you can also use the PLAY button and RECORD button for Manual Punch In/Out recording. (Please note that you can use these buttons only once.)

1. Start playing back from a point just before the punch in point.
 2. At the punch in point, press the RECORD button while holding down the PLAY button. (Punch In)
 3. At the punch out point, press only the PLAY button. (Punch Out)
- * You can also rehearse if you "press only the RECORD button" instead of steps 2 and 3 described above.

2-3. Undo/Redo of Manual Punch In/Out

* If you press the UNDO key after performing the manual punch in/out operation, the original sound recorded prior to auto punch in/out will be restored.

* If you press the REDO key after undoing the manual punch in/out operation, the manual punch in/out data will be restored.

<Note>

You can use the undo/redo functions while the D-160 is in stop mode.
Under the following circumstances, you will be unable to use the undo/redo functions;

1. If you make a new recording,
2. If you make a new edit (copy & paste, move & paste, or erase),
3. If the Auto Punch In point was passed in play or record mode while Auto Punch mode was on, or
4. If you turned off the power to the D-160, then turned it back on.
5. If you use the Program Change function.

Edit Function

This chapter describes the various editing functions on the D-160. The D-160 uses a hard disk as the recording media, which allows for non-linear, non-destructive, quick audio editing. The edit function includes the Copy & Paste, Move & Paste, and Erase functions.

<Precautions for editing>

The D-160 accommodates ninety-nine Programs, P1-P99, each of which you can record and edit individually. First, make sure that you are about to edit the correct Program. If you start editing without first checking the Program, you may lose important data. Refer to the Before operation section, "2-2. Program Change," for more information on how to set a Program. Do not change Programs or sampling rates until a session is complete.

<Differences between Copy & Paste and Move & Paste>

- * The Copy & Paste function allows you to copy data to the Clipboard, and paste it to any location in any track. In this case, the copy source data remains as is, as does the data on the Clipboard.
- * The Move & Paste function is almost the same as the Copy & Paste, except that executing the Move & Paste function will erase the move source data (the Clipboard will be also cleared).

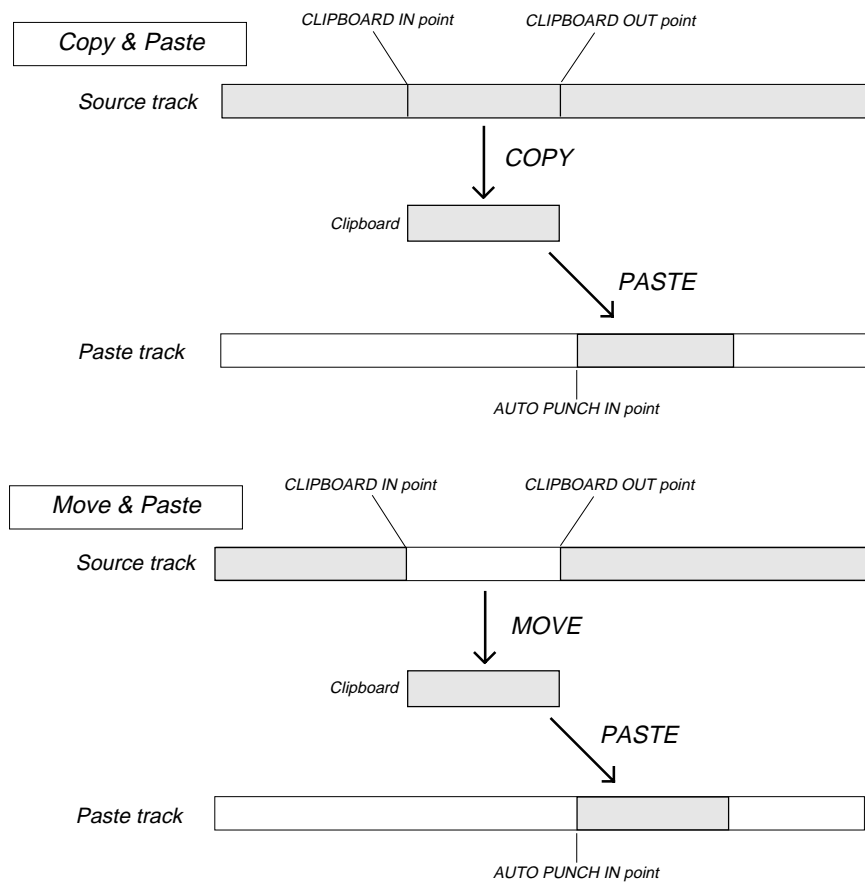

1. Copy & Paste

The Copy & Paste functions use the clipboard of the D-160, allowing you to copy sound data and paste it to the specified area. The copied data remains on the clipboard after you paste it, and you can paste the same data as many times as you want to different places. The Copy & Paste functions can reference any one of the following time bases: ABS time, MTC time, MIDI Bar/Beat/Clock.

- * To perform the Copy operation, you first need to set the start point (Clipboard In point) and the end point (Clipboard Out point) of the copied data and the copy source track.
- To perform the Paste operation, you need to set the start point (Auto Punch In point) and the paste destination point.

<Note-1>

The data on the Clipboard will be replaced by new data each time you press the COPY key of the MOVE key.

<Note-2>

If pasted data overlaps the source data, the content of the source data will be altered.

1-1. Copying

First, you need to specify the area to be copied (using the Clipboard In/Out points and copy track).

- * The following procedure is based on data with the ABS Time Base.
- To change the Time Base to MTC or MIDI BAR/BEAT/CLK, press the DISP SEL key while pressing and holding down the EXECUTE/YES key.
- * Before you start work, restore the default settings on the D-160.
- * Do not change Programs or sampling rates until a session is complete.

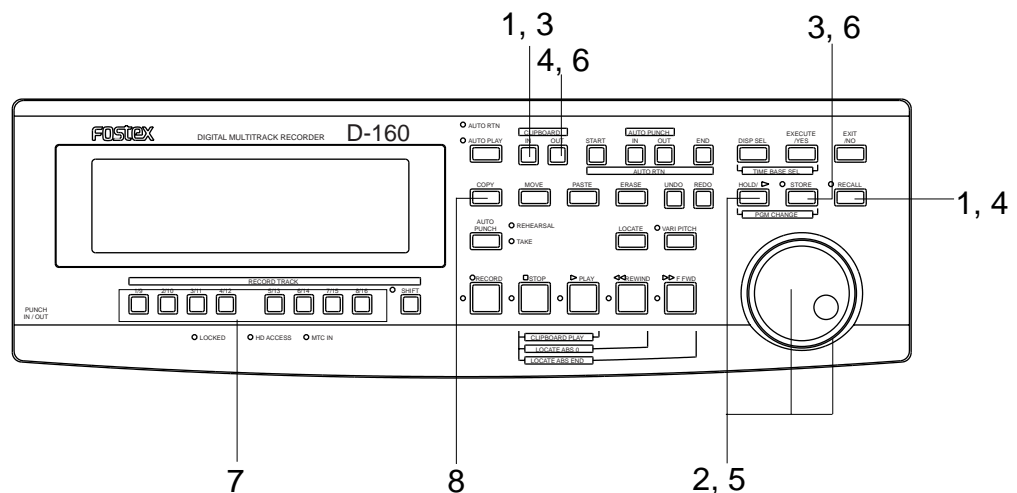

Entering and storing the CLIPBOARD IN point

1. Press the RECALL key, and then the CLIPBOARD IN key (or press only the CLIPBOARD IN key). The D-160 will enter the edit mode.
2. Move the cursor to the digit you wish to change using the HOLD/> key or the SHUTTLE dial, and change the value using the JOG dial.

3. After setting the value, press the STORE key, then the CLIPBOARD IN key.

The time value will be stored as the Clipboard In time, the edit mode will disengage, and the display will return to the previous screen.

Entering and storing the CLIPBOARD OUT point

4. Press the RECALL key, and then the CLIPBOARD OUT key (or press only the CLIPBOARD OUT key). The D-160 will enter the edit mode.

5. Move the cursor to the digit you wish to change using the HOLD/> key or the SHUTTLE dial, and change the value using the JOG dial.

6. After setting the value, press the STORE key, and then the CLIPBOARD OUT key.

The time value will be stored as the Clipboard Out time, the edit mode will disengage, and the display will return to the previous screen.

* To check the stored In/Out points, press the CLIPBOARD IN key and CLIPBOARD OUT key respectively. The time value you just stored will be shown on the display.

* You can perform steps 1-3 in real-time. (Pressing the STORE key, then the CLIPBOARD IN key while playing back the recorder will store data.)

<Hints>

When you are storing the In/Out points in real-time while using the "BAR/BEAT/CLK" Time Base, you can store them in steps of beats if the "Resolution?" menu (Bar/Beat Resolution mode ON/OFF) in Setup mode is "On."

When this bar/beat resolution menu is "On," the CLK value will be rounded to "00" (at the beginning of the beat) as soon as you press the STORE key.

This function is useful when you wish to use the Copy & Paste or Move & Paste function in setups of beats. Refer to page "160" for detailed operation.

Copying the track data after storing the CLIPBOARD IN/OUT points

7. Select the copy track using the RECORD TRACK select keys (you can select multiple tracks).

* You can select one (mono) track, multiple tracks, or all sixteen tracks.

When using the Copy & Paste function, however, you can change the paste destination track only when you have selected a mono track, or an odd-numbered track and the adjacent even-track (i.e.: 1-2, 3-4, or 13-14, 15-16).

If you have copied multiple tracks (other than the above combination), the data will be pasted to the copy source tracks. (track 1-> track 1.....track 3-> track 3 etc.)

8. Press the COPY key.

Upon finishing copying to the clipboard, "Copy Clip"/"COMPLETED!" will appear in the display and then return to the original time base display.

In this way, the specified part of the sound data of the selected track(s) is copied to the clipboard.

<Note 1>

If you press the COPY key without selecting a copy source track by the RECORD TRACK select key, the display will show "Select Track!" (meaning "Select a copy track.") and return to the previous screen. In this case, select a copy source track and try to copy the data again.

<Note 2>

If an Output point has been specified before the In point (the In point value is the same or large than the Out point value), the display will show the error message "Void In Point!" or "Void Out Point!" and return to the previous screen. In this case, set the correct In/Out points and try again to copy the data.

<Note 3>

The data on the Clipboard will be replaced by new data each time you press the COPY key or the MOVE key.

Listening to sound data copied on the clipboard (Clipboard Play function)

To listen to the sound data currently copied to the clipboard, press the PLAY button while holding down the STOP button (Clipboard Play mode). The data will be played back from the beginning. To stop the playback in the middle, press the STOP button.

* During the clipboard playback, the display show the position of the source data referenced to the selected time base.

1-2. Copy & Pasting

You can paste data to the same track as the source. For example, if you copied data on Track 1, data will be pasted on Track 1. Data will be pasted starting from the Auto Punch In point.

<Note>

You need enough unrecorded space on the hard disk to execute the Copy & Paste operation. If you press the PASTE key with insufficient disk space, the display will immediately show the error message "Over!", and then show the excess time using the currently-selected Time Base (time or bar). In this case, shorten the copy data by the amount of excess time. Alternatively, move ABS END backward using the ERASE function as described in page "96" of this manual in order to obtain more free space on the hard disk.

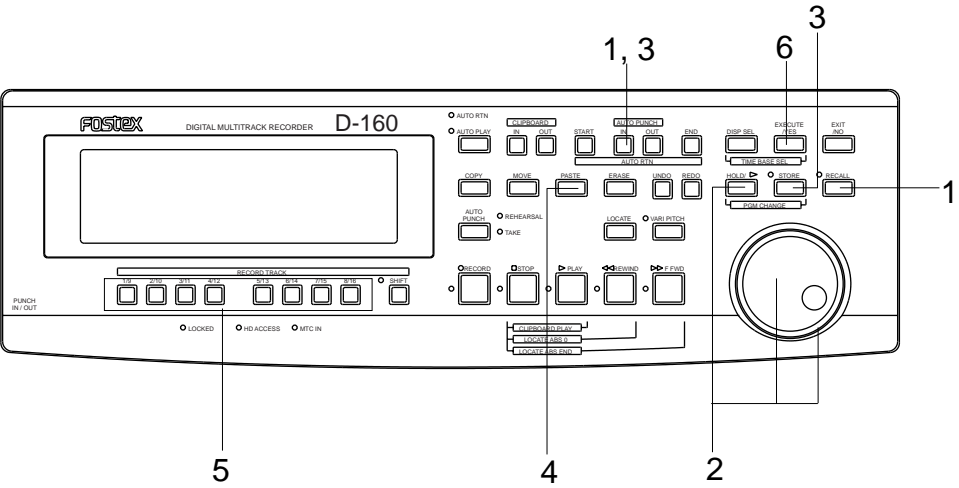

Entering and storing the paste Punch In point

1. Press the **RECALL** key, then the **AUTO PUNCH IN** key (or press only the **AUTO PUNCH IN** key). The D-160 will enter the edit mode.
2. Move the cursor to the digit you wish to edit using the **HOLD/>** key or the **SHUTTLE** dial, and set the value using the **JOG** dial.
3. After setting the time value, press the **STORE** key, and then the **AUTO PUNCH IN** key.
The time value will be stored as the start point of the pasting area, and the display will go back to the previous screen.

Executing the paste operation

4. Press the **PASTE** key.
When the **PASTE** key is pressed, "Copy Paste" is momentarily show in the display, then "Paste Repeat = 01 (01 blinks)" and "SURE?" will blink, and the copy source track display will be lit.
5. Specifying the copy destination track and the number of repeats to paste.
 - * **Specifying the Copy & Paste destination track:**
Select the destination track using the **RECORD TRACK** select key. (You do not need to specify the track if you are going to Copy & Paste data in the copy source track.)
 - * **Specifying the number of repeats to Copy & Paste:**
Turn the **JOG** dial to change the blinking number "01" to any value between 1 and 99. (If there is not enough free space on the hard disk, the repeat time will be limited to a number less than 99, and you will be unable to specify a larger number when you turn the **JOG** dial.)
6. Press the **EXECUTE/YES** key.
Simultaneous with execution of paste, the paste section length converted to mono track time length will be shown in the upper line of the display and "Copy Paste," "COMPLETED!" displayed after completing the paste.
Press the **EXIT/NO** key to go back to the previous screen.

Now the audio data on the Clipboard has been pasted to the specified track starting with the **AUTO PUNCH IN** point.
For example, executing the function with a repeat number of "Paste Repeat= 03" (three times) will paste the data as shown in the diagram below.

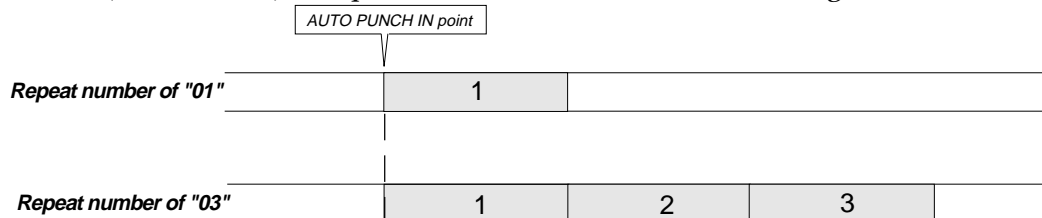

* To cancel the paste operation, press the **EXIT/NO** key while the message "SURE?" is blinking on the display.
If you wish to cancel the paste operation after you press the **EXECUTE/YES** key, press the **STOP** button or the **EXIT/NO** key before the "COMPLETED!" message appears on the display.
If you abort the paste operation using this procedure (even in the middle of the operation), no data will be pasted.

<Note 1>

The Copy & Paste function is available only when the hard disk has enough space (REMAIN) to perform the following Undo/Redo operation.

If you try to copy & paste the data without enough free space on the hard disk, the display will indicate the alarm message "Over !" (overtime error) as soon as you press the PASTE key, then indicate the excessive time in the currently-selected Time Base.

To avoid this, shorten the data to be copied, by the amount of the exceeding time, or use the Erase function to create free disk space as described below in order to move the ABS END point.

<Note 2>

Do not copy data and paste it partially over itself (same track and part of the same time frame). This will alter both the copy source data and the data currently contained in the clipboard.

If you accidentally do this, use the Undo function as explained in the following section. You will be unable to restore the original data if you proceed with editing without first performing the Undo operation.

You can also paste the move data repeatedly by specifying the number of repeats (1-99). The difference between "Move & Paste" and "Copy & Paste" is that moving data will cause the source sound data to move to the Clipboard, and then to the destination, and the data in the source or in the Clipboard will be erased.

This operation is available with any Time Base.

1-3. Copy & Paste Undo/Redo

If you wish to restore data that existed before you executed the Copy & Paste function, press the UNDO key to restore the status obtained before you pasted the data. Pressing the REDO key after pressing the UNDO key will restore the status before the Undo operation (that is, after pasting). The Undo and Redo functions are effective only when the D-160 is stopped.

After the UNDO key or REDO key is pressed, the display will show "Undo" or "Redo", and "COMPLETED!" and return to the previous screen.

<Note>

You can use the undo/redo functions while the D-160 is in the stop mode.

Under the following circumstances, you will be unable to use the undo/redo functions:

- 1.If you make a new recording,
- 2.If you make a new edit (Copy & Paste, Move & Paste, Erase),
- 3.If the Auto Punch In point was passed in play or record mode while Auto Punch mode was on, or
4. If you turned off the power to the D-160, then turned it back on.
5. If you use the Program Change function.

2. Move & Paste

The Move & Paste function “moves” sound data to the Clipboard, and “pastes” the data in the same track or another track. You can specify the number of repeats of the paste operation (1-99) to paste data repeatedly. The difference between the Copy & Paste and the Move & Paste operation is that, after the Move & Paste operation, the source data and the data on the Clipboard will be removed. You can use this function with any Time Base.

* To perform the Move operation, you first need to set the start point (Clipboard In point) and the end point (Clipboard Out point) of the data to be moved, and the move source track. To perform the Paste operation, you need to set the start point (Auto Punch In point) and the paste destination point.

<Note>

The data on the Clipboard will be replaced by new data each time you press the COPY key or the MOVE key.

2-1. Moving

First, you need to specify the area to be moved (using the Clipboard In/Out points and move track).

* The following procedure is based on data with the ABS Time Base.
 To change the Time Base to MTC or MIDI BAR/BEAT/CLK, press the DISP SEL key while pressing and holding down the EXECUTE/YES key.
 * Before you start working, restore the default settings on the D-160.
 * Do not change Programs or sampling rates until a session is complete.

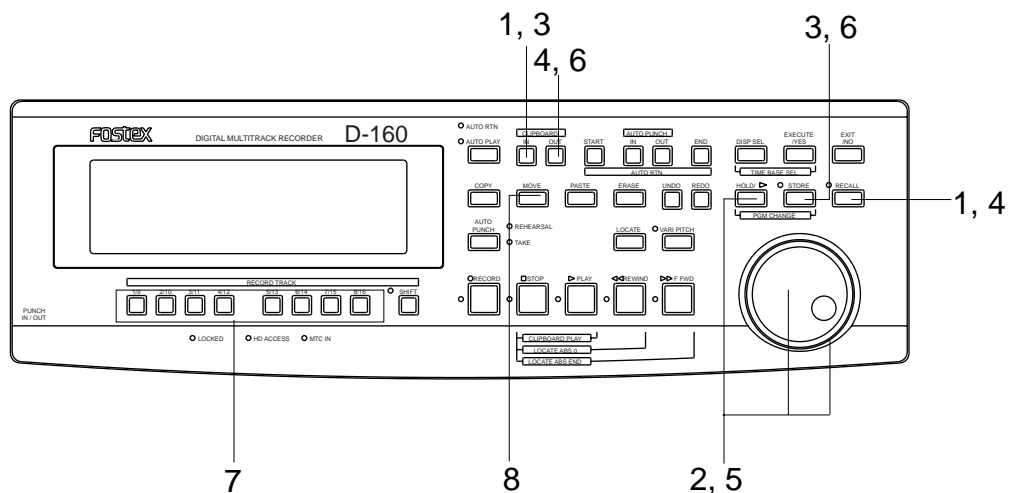

Entering and storing the CLIPBOARD IN point

1. Press the RECALL key, and then the CLIPBOARD IN key (or press only the CLIPBOARD IN key). The D-160 will enter the edit mode.
2. Move the cursor to the digit you wish to change using the HOLD/> key or the SHUTTLE dial, and change the value using the JOG dial.
3. After setting the value, press the STORE key, and then the CLIPBOARD IN key. The time value will be stored as the Clipboard In time, the edit mode will disengage, and the display will return to the previous screen.

Entering and storing the CLIPBOARD OUT point

4. Press the **RECALL** key, and then the **CLIPBOARD OUT** key (or press only the **CLIPBOARD OUT** key). The D-160 will enter the edit mode.
5. Move the cursor to the digit you wish to change the **HOLD/>** key or the **SHUTTLE dial**, and change the value using the **JOG dial**.
6. After setting the value, press the **STORE** key, and then the **CLIPBOARD OUT** key.

The time value will be stored as the Clipboard Out time, the edit mode will disengage, and the display will return to the previous screen.

* To check the stored In/Out points, press the **CLIPBOARD IN** key and **CLIPBOARD OUT** key respectively. The time value you just stored will be shown on the display.

* You can perform steps 1-3 in real-time. (Pressing the **STORE** key, then the **CLIPBOARD IN** key while playing back the recorder will store data.)

<Hints>

When you are storing the In/Out points in real-time while using the "BAR/BEAT/CLK" Time Base, you can store them in steps of beats if the "↓Resolution?" menu (Bar/Beat Resolution mode ON/OFF) in the Setup mode is "On."

When this bar/beat resolution mode is "On," the CLK value will be rounded up or off to "00" (at the beginning of the beat) as soon as you press the **STORE** key. This function is useful when you wish to use the Copy & Paste or Move & Paste function in steps of beats. Refer to page "160" for detailed operation.

Moving the track data after storing the CLIPBOARD IN/OUT points

7. Select the move track using the **RECORD TRACK** select keys (you can select multiple tracks).

* You can select one (mono) track, multiple tracks, or all sixteen tracks.

When using the Copy & Paste or Move & Paste function, however, you can change the paste destination track only when you have selected a mono track, or an odd-numbered track and the adjacent even-numbered track (i.e.: 1-2, 3-4, or 13-14, 15-16). If you have moved multiple tracks (other than the above combination), the data will be pasted to the move source tracks. (track 1-> track 1.....track 3-> track 3 etc.)

8. Press the **MOVE** key.

Upon finishing moving in the clipboard, "Move Clip"/"COMPLETED!" will appear in the display and then return to the original time base display.

Now the sound data in the specified track has been moved to the Clipboard. At this point, the move source data has yet been deleted. It will be deleted after you perform the paste operation.

<Note 1>

If you press the MOVE key without selecting a move source track by the RECORD TRACK select key, the display will show "Select Track!" (meaning "Select a move track.") and return to the previous screen. In this case, select a move source track and try again to copy the data.

<Note 2>

If the Output point has been specified before the In point (the In point value is the same or large than the Out point value), the display will show the error message "Void In Point!" or "Void Out Point!" and return to the previous screen. In this case, set the correct In/Out points and try again to move the data.

<Note 3>

The data on the Clipboard will be replaced by new data each time you press the COPY key or the MOVE key.

Listening to sound data moved on the clipboard (Clipboard Play function)

To listen to the sound data currently moved to the clipboard, press the PLAY button while holding down the STOP button (Clipboard Play mode). The data will be played back from the beginning. To stop the playback in the middle, press the STOP button.

* During the clipboard playback, the display shows the position of the source data referenced to the selected time base.

2-2. Move & Pasting

The data will be move & pasted at the point stored in the Auto Punch In key. You can select the paste destination track the RECORD TRACK select key.

<Note>

You need to have enough unrecorded space on the hard disk to execute the Move & Paste operation. If you press the EXECUTE/YES key to try to paste data with insufficient disk space, the display will immediately show the error message "Over!", and then show the excess time using the currently-selected Time Base (time or bar).

In this case, shorten the move data by the amount of excess time. Alternatively, move ABS END backward using the Erase function as described in page "96" of this manual in order to obtain more free space on the hard disk.

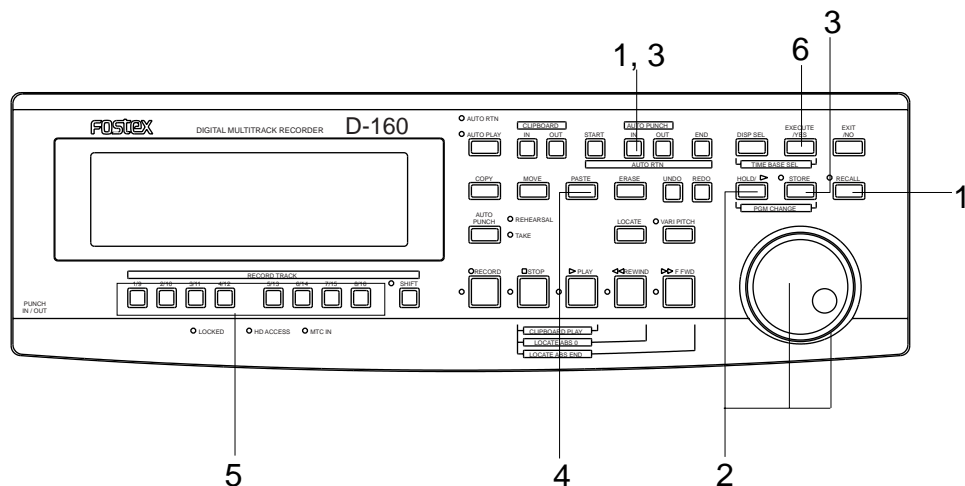

Entering and storing the paste Punch In point

1. Press the **RECALL** key, and then the **AUTO PUNCH IN** key (or press only the **AUTO PUNCH IN** key). The D-160 will enter the edit mode.
2. Move the cursor to the digit you wish to edit using the **HOLD/>** key or the **SHUTTLE dial**, and set the value using the **JOG dial**.
3. After setting the time value, press the **STORE** key, and then the **AUTO PUNCH IN** key.
The time value will be stored as the start point of the pasting area, and the display will return to the previous screen.

Executing the paste operation

4. Press the **PASTE** key.
When the **PASTE** key is pressed, "Move Paste" is momentarily shown in the display, then "Paste Repeat = 01 (01 blinks)" and "SURE?" will blink, and the move source track display will be lit.
5. Specify the Move & Paste destination track and the number of repeats to paste.
 - * **Specifying the Move & Paste destination track:**
Select the destination track using the **RECORD TRACK** select key. You do not need to specify a track if you are going to Move & Paste data in the copy source track.
 - * **Specifying the number of repeats to Move & Paste:**
Turn the **JOG dial** to change the blinking number "01" to any value between 1 and 99. If there is not enough free space on the hard disk, the repeat time will be limited to a number less than 99, and you will be unable to specify a larger number when you turn the **JOG dial**.
6. Press the **EXECUTE/YES** key.
Simultaneous with the execution of paste, the paste section length converted to mono track time length will be shown in the upper line of the display and "Move Paste," "COMPLETED!" displayed after completing the paste.
Press the **EXIT/NO** key to return to the previous screen.

Now the audio data on the Clipboard has been pasted to the specified track starting with the **AUTO PUNCH IN** point.
For example, executing the function with a repeat number of "Paste Repeat= 03" (three times) will paste the data as shown in the diagram below.

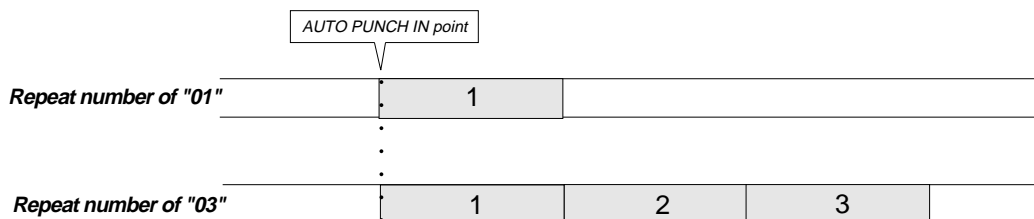

* To cancel the paste operation, press the **EXIT/NO** key while the message "SURE?" is blinking on the display.
If you wish to cancel the paste operation after you press the **EXECUTE/YES** key, press the **STOP** button or the **EXIT/NO** key before the "COMPLETED!" message appears on the display.
If you abort the paste operation using this procedure (even in the middle of the operation), no data will be pasted.

<Note 1>

The data on the Clipboard will be cleared after the Move & Paste operation is complete. Unlike the Copy & Paste operation, you cannot repeatedly move and paste the same data.

<Note 2>

The Move & Paste function is available only when the hard disk has enough space (REMAIN) to perform the following Undo/Redo operation.

If you try to move & paste the data without enough free space on the hard disk, the display will indicate the alarm message "Over !" (overtime error) as soon as you press the PASTE key, then indicate the excessive time in the currently-selected Time Base. To avoid this, shorten the data to be copied, by the amount of the exceeding time, or use the Erase function to create free disk space as described later in order to move the ABS END point.

<Note 3>

Do not copy data and paste it partially over itself (same track and part of the same time frame). This will alter both the copy source data and the data currently contained in the clipboard.

If you accidentally do this, use the Undo function as explained in the following section. You will be unable to restore the original data if you continue to edit without first performing the Undo operation.

You can also paste the move data repeatedly by specifying the number of repeats (1-99). The difference between "Move & Paste" and "Copy & Paste" is that moving data will cause the source sound data to move to the Clipboard, then to the destination, and the data in the source or in the Clipboard will be erased.

This operation is available with any Time Base.

2-3. Move & Paste Undo/Redo

If you wish to restore data that existed before you executed the Move & Paste function, press the UNDO key to restore the status obtained before you pasted the data. Pressing the REDO key after pressing the UNDO key will restore the status before the Undo operation (that is, after pasting). The Undo and Redo functions are effective only while the D-160 is stopped.

After the UNDO key or REDO key is pressed, the display will show "Undo", "Redo" and "COMPLETED!" and return to the previous screen.

<Note>

You can use the undo/redo functions while the D-160 is in stop mode. Under the following circumstances, you will be unable to use the undo/redo functions:

- 1.** If you make a new recording,
- 2.** If you make a new edit (Copy & Paste, Move & Paste, or Erase,
- 3.** If the Auto Punch In point was passed in play or record mode while Auto Punch mode was on, or
- 4.** If you turned off the power to the D-160, then turned it back on.
- 5.** If you use the Program Change function.

3. Erase

There are three ways to erase data. Make sure that you learn the difference ways to erase to avoid mistakes.

Erasing data for a specific part between ABS 0 and ABS END:

You can erase data (make silence) from the Auto Punch In point up to the Auto Punch Out point between ABS 0 - ABS END. You may specify a mono track, multiple tracks, or all 16 tracks for the erase operation. As shown in the diagram below, this operation erases data for any specified part between ABS 0 and ABS END. But, the ABS END position will not be affected. The REMAIN value (available recording time based on a single mono track) will increase by the amount you erase.

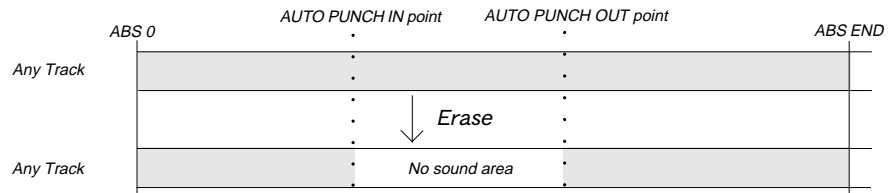

Erasing all data from a specified point up to ABS END:

You may erase data from a specified point (Auto Punch In point) up to ABS END of a selected Program. You need to specify the erase start point as the Auto Punch In point, and the ABS END point (the end point of recording) or any point (time) after the ABS END point as the Auto Punch Out point. You may specify a mono track, multiple tracks, or all 16 tracks for the erase operation. If you specify all tracks, the ABS END point of the selected Program will move back and the REMAIN value will increase. If you specify any other track combination, the ABS END point will not move; only the REMAIN value will increase.

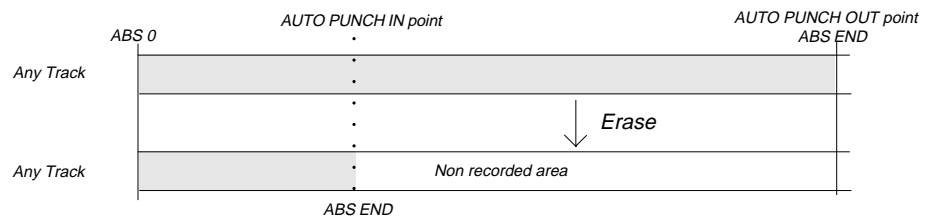

Erasing specific Program data (Program Erase):

This function enables you to erase data entirety from a selected program and return the initial settings of this program to its initial figures.

Unlike the other two erase functions, for Program Erase you do not need to specify tracks or set the Auto Punch In/Out points. Executing this erase function will erase all data recorded in the selected Program. The ABS time and the REMAIN value will return to their default settings. Use caution, since you cannot UNDO this erase operation.

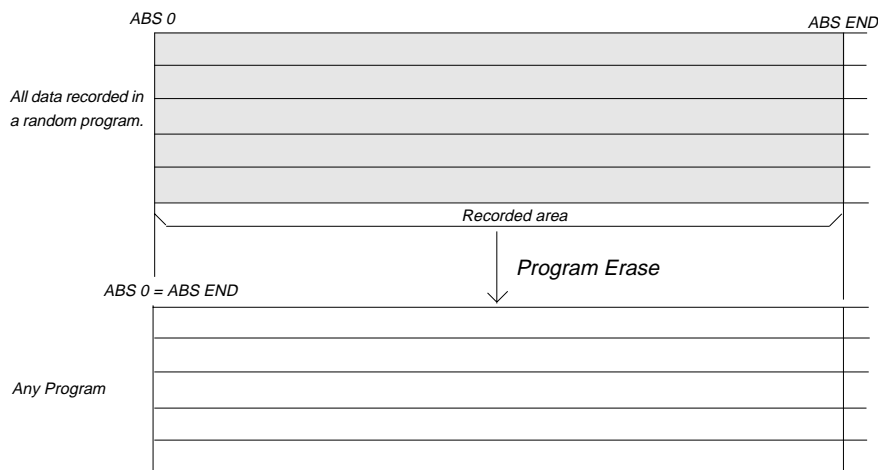

3-1. How to Erase data for a specific part between ABS 0 and ABS END

Storing the erase start point (Auto Punch In point) and the erase end point (Auto Punch Out point)

Refer to "1. Storing memory data," to set the Auto Punch In/Out points.
Here, we use the procedure to "edit the stored data."

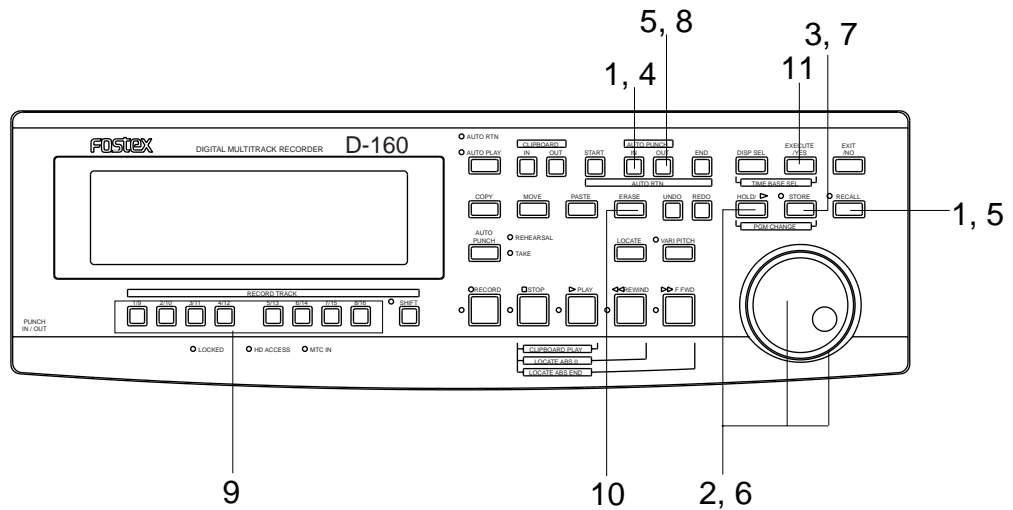

1. **Press the AUTO PUNCH IN key. (Or, press the RECALL key, then press the AUTO PUNCH IN key.)**
The time value of the Auto Punch In point (bar/beat/clock) appears and the D-160 will enter the data edit mode.
2. **Use the HOLD/> key or the SHUTTLE dial to move among the digits of the time value (bar/beat/clock), and use the JOG dial to change the value.**
3. **Press the STORE key. (The STORE LED lights up.)**
4. **Press the AUTO PUNCH IN key.**
The changed time value (bar/beat/clock) is stored as a new Auto Punch In point, and the Time Base indication will appear on the display. (The STORE LED turns off.)
5. **Press the AUTO PUNCH OUT key. (Or, press the RECALL key, then press the AUTO PUNCH OUT key.)**
The time value of the Auto Punch Out point (bar/beat/clock) will appear and the D-160 will enter the data edit mode.
6. **Use the HOLD/> key or the SHUTTLE dial to move among the digits of the time value (bar/beat/clock), and use the JOG dial to change their value.**
7. **Press the STORE key. (The STORE LED lights up.)**
8. **Press the AUTO PUNCH OUT key.**
The changed time value (bar/beat/clock) is stored as a new Auto Punch Out point, and the Time Base indication appears on the display. (The STORE LED turns off.)

* To check the Auto Punch In/Out points, press the AUTO PUNCH IN/OUT keys respectively. Or, press the RECALL key, and then press the AUTO PUNCH IN/OUT keys respectively. The display will indicate the time value (bar/beat/clock) stored for the Auto Punch In point or Auto Punch Out point.

Executing the erase operation

9. **Press the RECORD TRACK select key for any track(s) you wish to erase (up to 16 tracks) so that the corresponding track(s) enter "READY" mode.**
10. **Press the ERASE key.**
The message "Erase" appears on the display, and "SURE?" flashes.
11. **Press the EXECUTE/YES key.**
This executes the erase operation. The display will indicate "Wait Erasing!". When the erase operation is complete, the message "COMPLETED!" will light along with the message "Erase."

Press the EXIT/NO key, DISP SEL key, or the STOP button to restore the original display.

The sound data in the specified range has been erased.

* To cancel the erase operation while the message "SURE?" is flashing on the display, press the EXIT/NO key or the STOP key.

* If you wish to cancel the erase operation after you have pressed the EXECUTE/YES key, press the EXIT/NO key or the STOP button BEFORE the message "COMPLETED!" appears.

* If you cancel the erase operation during the process, nothing will be erased.

<Check points>

Erasing the specified area between ABS 0 and ABS END will not affect the ABS END position. You can confirm this by pressing the F. FWD button while holding down the STOP button after the erase operation is complete. You will see no change in the ABS END time on the display. This means that erasing the specified area has replaced the data with silence, without moving the ABS END point .

However, the available recording time will increase by the amount of data you erased. You can check this by pressing the DISP SEL key to see the REMAIN value calculated based on a single mono track.

3-2. Undo and redo of the erase operation

You can use the Undo and Redo functions for the erase operation.

*** After the erase operation is complete, press the UNDO key.**

The D-160 will restore the data that existed before you executed the erase operation.

*** Press the REDO key after using the UNDO function.**

The D-160 will restore the status that existed after you executed the erase operation.

Pressing the UNDO key or the REDO key will execute the corresponding operation immediately, and the display will indicate the messages "COMPLETED!" and "Undo!" or "Redo!", and then return to the previous Time Base indication.

<Note>

You can use the Undo/Redo function while the D-160 transport section is stopped. You cannot use the Undo/Redo function after one of the following operations:

1. You make a new recording.
2. You perform a new editing operation (such as copy & paste, move & paste, and erase).
3. When the Auto Punch mode is on, and playback or recording passes the Auto Punch In point.
4. You turn off the power.
5. You use the Program Change function.

3-3. How to Erase data in its entirety from a specified point up to ABS END:

Storing the erase start point (Auto Punch In point) and the erase end point (Auto Punch Out point)

Refer to "1. Storing memory data," to set the Auto Punch In/Out points.
Again, we use the procedure to "edit the stored data."

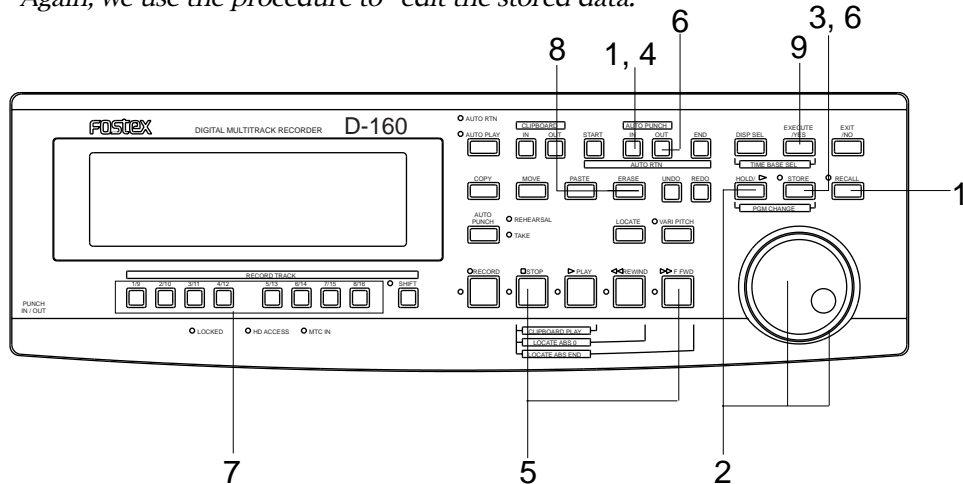

1. Press the AUTO PUNCH IN key. (Or, press the RECALL key, then press the AUTO PUNCH IN key.)

The time value of the Auto Punch In point (bar/beat/clock) appears and the D-160 will enter the data edit mode.

2. Use the HOLD/> key or the SHUTTLE dial to move among the digits of the time value (bar/beat/clock), and use the JOG dial to change the value.

3. Press the STORE key. (The STORE LED lights up.)

4. Press the AUTO PUNCH IN key.

The changed time value (bar/beat/clock) is stored as a new Auto Punch In point, and the Time Base indication appears on the display. (The STORE LED turns off.)

5. Press the F.FWD button while holding down the STOP button.

The D-160 will indicate the ABS END (the recording end) point of the selected Program.

* To make sure the data is erased completely, we recommend that you specify a time after the ABS END point as an erase end point (Auto Punch Out point). To do so, press the PLAY button following Step 5 so that the ABS time passes the ABS END time. Use the ABS time, which is now positioned after the ABS END point, as an erase end point.

6. Press the STORE key, then the AUTO PUNCH OUT key.

The ABS END point is stored as a new Auto Punch Out point.

* To check the Auto Punch In/Out points, press the AUTO PUNCH IN/OUT keys respectively. Or, press the RECALL key, then press the AUTO PUNCH IN/OUT keys respectively. The display will indicate the time value (bar/beat/clock) stored for the Auto Punch In point or Auto Punch Out point.

Executing the erase operation

7. Press the RECORD TRACK select key for a track you wish to erase (up to 16 tracks) so that the corresponding track(s) enters "READY" mode.

8. Press the ERASE key.

The message "Erase" appear on the display, and "SURE?" will flash.

9. Press the EXECUTE/YES key.

This executes the erase operation. The display will indicate "Wait Erasing!". When the erase operation is complete, the message "COMPLETED!" will light along with the message "Erase." Press the EXIT/NO key, DISP SEL key, or the STOP button to restore the original display.

The sound data between the Auto Punch In point and the ABS END point has been erased. This area does not contain a recording, and the available recording time on the disk (REMAIN value) increases.

- * To cancel the erase operation while the message “SURE?” is flashing on the display, press the EXIT/NO key or the STOP key.
- * If you wish to cancel the erase operation after you have pressed the EXECUTE/YES key, press the EXIT/NO key or the STOP button BEFORE the message “COMPLETED!” appears.
- * If you cancel the erase operation during the process, nothing will be erased.

<Check points>

Although erase is executed on other than all tracks (mono track or multiple tracks), the ABS END which is the final recording position of the program, will not be affected (ABS END will be affected, however, if it is erased as shown below).

After execution of erase, upon confirming the ABS END time by simultaneously pressing the STOP and F. FWD buttons, you will notice that it is the same ABS END as that before erasing. However, if REMAIN is put on display by pressing the DISP SEL key, REMAIN (disk remaining time) can be confirmed to have increased by the erased time converted to mono track. In order to shift the ABS END forward, carry out the previous step by specifying all recorded tracks.

<Example>

When there is a recording on tracks 1~6 of a certain program as shown below, if it is located to ABS END, this located ABS END will be at final recording point of tracks 3 and 4, and the time will always be shown in the display.

Therefore, although tracks 1 and 2 or 5 and 6 of a program with such a content is erased (from any point to ABS END), ABS END that is always displayed will be the track 3 and 4 time. However, if tracks 3 and 4 are erased, ABS END will change.

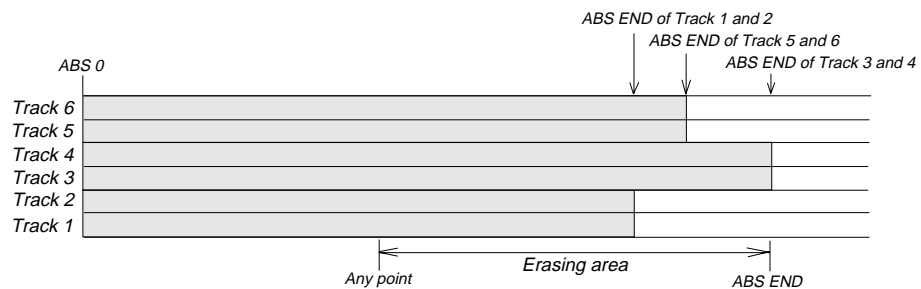

3-4. Undo and redo of the erase operation

You can use the Undo and Redo functions for the erase operation.

*** After the erase operation is complete, press the UNDO key.**

The D-160 will restore the data that existed before you executed the erase operation.

*** Press the REDO key after using the UNDO function.**

The D-160 will restore the status that existed after you executed the erase operation.

Pressing the UNDO key or the REDO key will execute the corresponding operation immediately, and the display will indicate the messages “COMPLETED!” and “Undo!” or “Redo!”, and then return to the previous Time Base indication.

<Note>

You can use the Undo/Redo function while the D-160 transport section is stopped.

You cannot use the Undo/Redo function after one of the following operations:

1. You make a new recording.
2. You perform a new editing operation (such as copy & paste, move & paste, and erase).
3. When the Auto Punch mode is on, and playback or recording passes the Auto Punch In point.
4. You turn off the power.
5. You use the Program Change function.

3-5. Erasing specific data (Program erase)

Here, erase all data recorded in any program that is no longer necessary. Unlike the "erasing the program" explained in "Recording/Playback", the program number will remain intact and other settings will all be in the initial state same as when the New Program was made (at completion of erase, ABS 0=ABS END). Therefore, the tempo map setting and program title will be in the initial figures.

<Note>

Note that the UNDO/REDO function cannot be used at Program Erasing.

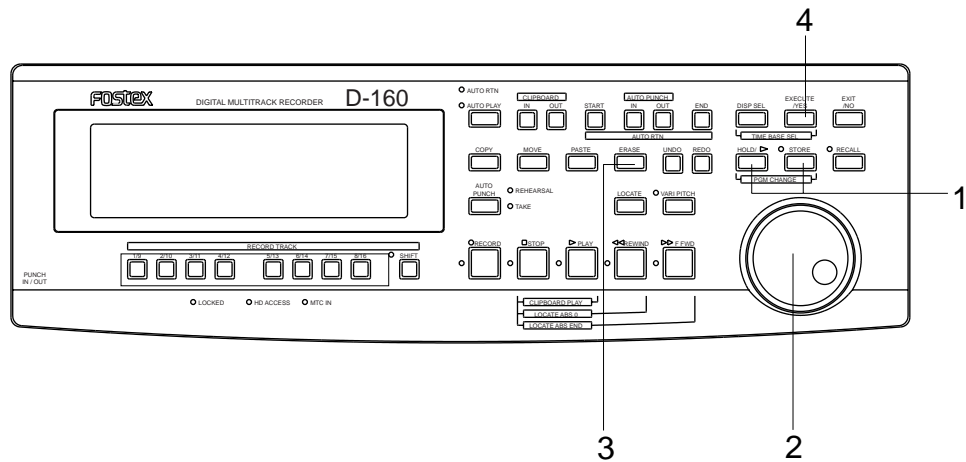

1. Press the **STORE** key while holding down the **HOLD/>>** key.

The D-160 will enter the Program Setup mode, and display the message "Select PGM!", and then the current Program number and title. (The Program number and "SURE?" will flash.)

Example: **"Select PGM!"** -> **"P02 [*****"**
(02 flash, 02 is the current program number)

2. Turn the **JOG** dial to select the number of a Program you wish to erase.

The selected Program number will flash. (Can not use "New Program?")

3. Press the **ERASE** key.

The message **"Erase PGM**?"** (where, ** is the selected Program number) appears on the display, and "SURE?" will flash.

4. Press the **EXECUTE/YES** key.

When the erase operation is completed, the display changes to the **"Title Edit PGM**?"** menu in Setup mode, where you can name the Program from which you erased the data.

* To name the Program, follow the explanation on page "147" regarding the "2-4. Title Edit PGM?" menu in Setup mode.

If you do not wish to name the Program, press the STOP button or the EXIT/NO key.

The display will change to the ABS indication, with the Program number unchanged.

The title of the Program is erased, and the Program will use a temporary title.

Saving and loading data

The D-160 allows you to select the data (audio data and Setup data) from a current Program and save it to a DAT machine as an S/PDIF digital signal or to an adat machine as an adat digital signal, or save it to a SCSI device.

You can also re-load the saved data to the D-160. In particular, using a SCSI device enables you to save and load the data of all Programs (up to 99 Programs), as well as an individual Program. These save and load functions are convenient when you wish to store Programs (complete or in progress) temporarily to a DAT, adat, or SCSI device to clear enough space on the internal hard disk to make new recordings.

*******About saved and loaded data*******

The data format and time taken to save or load data varies depending on how you save or load the data as follows:

S/PDIF digital signal (You can save and load each Program individually.):

Audio data will be output following a pilot signal of about five seconds.

In the S/PDIF digital signal format, two tracks of audio data (the black part in the diagram) are input/output at a time (total of eight times, or twelve times if additional tracks are included). Therefore, saving/loading one Program takes eight times longer (or twelve times including the additional tracks) than the Program's actual recording time (time duration from ABS 0 to ABS END). When a pilot signal and Setup data (the grey part in the diagram) are output or input, you will hear the beep sound, which enables you to confirm the position of those signals.



adat digital signal (You can save and load each Program individually.):

Audio data will be output following a pilot signal of about five seconds.

In the adat digital signal format, eight tracks of audio data (the black part in the diagram) are input/output at a time. Therefore, saving/loading one Program takes twice long (or three times including the additional tracks) as the Program's actual recording time (time duration from ABS 0 to ABS END). When a pilot signal and Setup data (the grey part in the diagram) are output or input, you will hear a beep sound, which enables you to confirm the position of those signals.



SCSI (You can save and load each Program individually or all Programs at once.):

Only SCSI devices allow you to save the song data of all setup Programs. All sixteen tracks (24 tracks including the additional tracks) of audio data (the black part in the diagram) will be input/output at a time. Therefore, the time taken to save or load one Program is much shorter than an operation using a DAT or adat. No pilot signal or beep sound will be recorded during the operation.

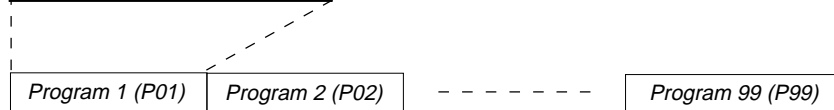
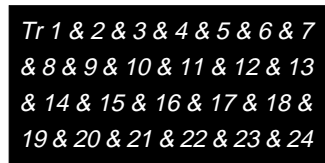

*** The following items can be saved and loaded as song data:**

Memory data (CLIPBOARD IN/OUT, AUTO RTN START/END, AUTO PUNCH IN/OUT)

Time Base (ABS, MTC, or BAR/BEAT/CLK)

Setup mode:

* Time signature setting (BAR BEAT), * Tempo setting, * Click On/Off setting

* Preroll Time setting, * Midi Sync Out setting, * MTC Frame Rate setting

* MTC Offset setting, * MTC Offset Mode setting, * Rec Protect On/Off setting

* Slave Mode on/off setting, * Slave Type setting, * FS (sampling frequency) setting

*** The following items cannot be saved or loaded as song data:**

Auto Play mode and Auto Return mode On/Off

Vari-pitch mode On/Off, and pitch data

Setup mode:

* Digital In setting, * Digital Out setting, * Bar/Beat Resolution On/Off setting

* Device ID setting

<Notes>

* You can save or load only one Program to and from a DAT or adat at a time.

Use a SCSI device to save or load all Programs.

* The D-160 can only save and load data to and from digital devices that support non-compression recording, and S/P DIF or adat format digital recording functions.

Basically, any device that supports the adat format can be used for the D-160's saving and loading operation.

However, for the S/P DIF format, you cannot use an MD or DCC that employs compression recording system, a CD-R machine that automatically corrects the interval between Programs, or other devices that automatically change the sampling rate. Devices with SCMS can be used if they satisfy the conditions described above.

Basically, any digital device that supports non-compression recording, and the S/P DIF or adat formats, should be able to save and load the D-160's data correctly. However, some devices may not, due to the occurrence of multiple errors. The following Fostex models have been tested and approved for the save and load operation:

FOSTEX: D-15, D-10, D-5

1. Saving the data using DATA OUT

- * Restore the initial settings on the D-160.
- * Set the same sampling rate on the external digital device and the D-160.

Connecting an external device

Connect DATA OUTPUT 1-8 connector of the D-160 to the digital input connector on the external digital device.

<Notes>

- * The D-160 has DATA OUT connectors for an S/P DIF digital signal (OPTICAL) and for an adat digital signal. These connectors have the same shape but carry different information.
- * Use the DATA OUTPUT 1-8 connector to save data. Do not use the DATA OUTPUT 9-16 connector.
- * At save/load using DAT and adat, independent save/load in 8 track units is possible. In this case, the data in 8 track units are not distinguished as track 1~8 or 9~16 but simply handled as eight track data. Therefore, because this 8 track data is compatible with D-90 if it is in 8 track units (any one combination of 1~8, 9~16 or 17~24), data saved from D-160 can be loaded in tracks 1~8 of the D-90. In this case, data in the tracks which were not loaded will remain intact.

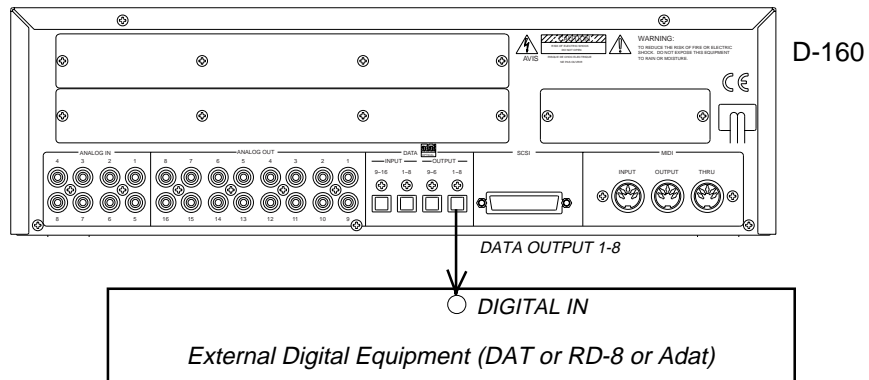

- If the external device has only COAXIAL type (RCA) digital I/O connectors, connect an optional COP-1 (optical/coaxial converter) to use an S/P DIF digital signal.
- Connecting both output and input connectors on the D-160 to the input and output connectors on the external digital device respectively may generate a digital loop. Refer to "4-3. Connecting a digital mixer" on page "65" for more information.

Setting up an external device

1. Set the same sampling rate to that of the D-160.
2. Select digital input on the external device so that the external device will accept a digital signal. On some external devices, you may have to set up so that the external device will synchronize with the incoming digital signal. For example, if you are using a Fostex RD-8, select "DIGITAL IN" and set "Clock Source (external sync signal)" to "Word Optical (adat)."

<Note>

If the external device does not accept the digital signal or if you notice digital noise, check the connection, cabling, and the settings of the D-160 and the external device.

- * Refer to the instruction manuals that came with any external digital device for details.

Executing the save operation

Use the "Save PGM?" menu in Setup mode.

- * Output format available: adat, DAT, SCSI
- * Programs available: P1 - P99
- * You can save one Program at a time.

1. **Press the DISP SEL key to select "SETUP" ("SETUP" will flash), then press the EXECUTE/YES key. ("SETUP" will light up.)**
The D-160 enters Setup mode.
2. **Use the JOG dial to select "Save PGM?" ("?" will flash.).**
3. **Press the EXECUTE/YES key.**
The message "Save Device?" and an indication of the digital signal to be saved ("DAT," "adat," or "SCSI") will flash on the display.
4. **Rotate the JOG dial to select a type of digital signal format to be used for the save operation.**
Selecting "adat" will save data in the adat digital signal format.
Selecting "DAT" will save data in the S/P DIF digital signal format.
Select "SCSI" if you are saving or loading data via SCSI. The following operation will be that when "adat" or "DAT" is selected for "Save Device?."
5. **Press the EXECUTE/YES key.**
Selection of the digital signal format for the save operation will be confirmed, and the existing Program numbers will flash on the display.
6. **Rotate the JOG dial to select a Program to save.**
You can select any existing Program (up to 99) to save.
7. **Press the EXECUTE/YES key.**
The duration of the selected Program appears on the display so that you can edit the time shorter or longer, as necessary. Time length recorded in the selected program will be displayed and the time can now be edited. Normally, it is saved in the time displayed but at this stage, it is also possible to save in any shorter time or by setting the time longer than what is actually recorded. This function is provided for the purpose of saving in a short section of insufficient tape capacity. Maximum saving time is 60 minutes.
8. **Press the EXECUTE/YES key again.**
"Save Trk? 1-16" ("1" is flashing) appears on the display and you can select tracks to save. While "1" is flashing, rotate the JOG dial to select "1"->"9"->"17." To select "8"->"16"->"24," use the SHUTTLE or press the HOLD/> key to flash "16" and rotate the JOG wheel.
You can select one of the following track combinations: "1-8," "1-16," "1-24," "9-16," "17-24." (Tracks 17-24 are additional tracks. Selecting "1-24" or "9-24" will cause the additional tracks to be saved along with the real tracks.)
9. **Press the EXECUTE/YES key.**
"Rec Start DAT!" (Start recording on the DAT) or "Rec Start adat!" (Start recording on the adat) appears on the display, and "SURE?" flashes.
10. **Confirm that the external device is syncing with the digital input signal, and start recording on the external device (DAT or adat).**
Setting a START-ID (DAT) or a locate point at the recording start point will facilitate future loading operations.
11. **Confirm that the recording on the external device has started, and press the EXECUTE/YES key. ("REMAIN" will light.)**
The save operation starts, and the time required for the save operation appears on the display and a few seconds later, it will start counting down. This few seconds delay is due to the pilot signal which is recorded to mark the beginning of the Program to facilitate future load operation. Therefore, the actual save operation starts when counting down starts.
Two tracks are saved each time in the order of Track 1 and 2, 3 and 4, etc. to a DAT machine.
Eight tracks are saved each time in the order of Track 1-8, 9-16, etc. to an adat machine.
The level meter indication during save of DAT will always be for only tracks 1 and 2 and always for tracks 1~8 in save of adat.
12. **When the save operation is complete, "COMPLETED!" flashes on the display.**
13. **Press the STOP button or the EXIT/NO key to quit the Setup mode. The display will return to the previous time base indication.**

• To cancel the operation or restore the indication shown before you pressed the EXECUTE/YES key, press the STOP button or the EXIT/NO key. Pressing one of these keys repeatedly takes you to the previous layer, finally quitting the Setup mode, and the display will return to the previous time base indication. If you press the STOP button or the EXIT/NO key any time after you execute the save operation but before it is complete, the saved song data will be invalid.

* Refer to page "168" for more information on the "2-23. Save PGM?" menu in Setup mode.

2. Loading the data using DATA IN

- * Restore the initial settings on the D-160.
- * Set the same sampling rate on the external digital device and the D-160.

Connecting the external device

Connect DATA INPUT 1-8 connectors of the D-160 to the digital output connectors on the external digital device.

<Notes>

- * The D-160 has DATA INPUT connectors for an S/P DIF digital signal (OPTICAL) and for an adat digital signal. These connectors have the same shape but carry different information.
- * Use the DATA INPUT 1-8 connector to load data. Do not use the DATA INPUT 9-16 connector.
- * When save/load using DAT and adat, independent save/load in 8 track units is possible. In this case, the data in 8 track units are not distinguished as track 1~8 or 9~16 but simply handled as eight track data. Therefore, as this 8 track data is compatible with D-90 if it is in 8 track units (any one combination of 1~8, 9~16 or 17~24), data saved from D-160 can be loaded in tracks 1~8 of the D-90. In this case, data in the tracks which was not loaded will remain intact.

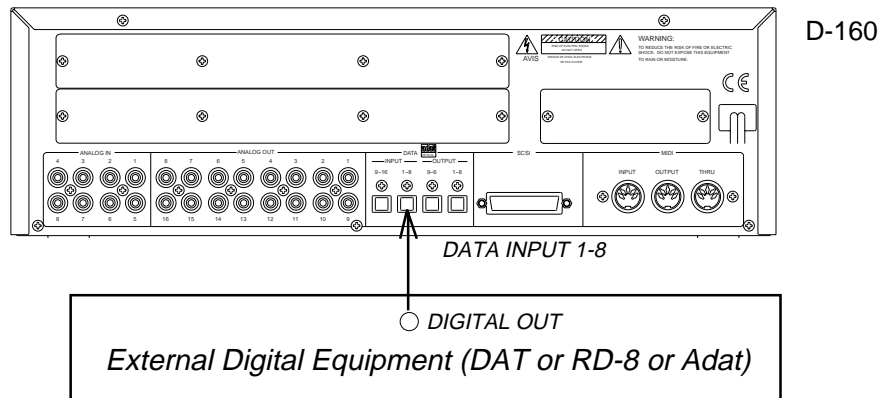

- If the external device has only COAXIAL type (RCA) digital I/O connectors, connect an optional COP-1 (optical/coaxial converter) to use an S/P DIF digital signal.
- Connecting both output and input connectors on the D-160 to the input and output connectors on the external digital device respectively may generate a digital loop. Refer to "4-3. Connecting a digital mixer" on page "65" for more information.

Setting up an external device

1. Setup the external device so that it can output a digital signal.
2. Locate the beginning of the pilot signal recorded in the saved data.

* Refer to the instruction manual that came with your external digital device for details.

Executing the load operation

You will use the "Load PGM?" menu in Setup mode.

- * Input format available: adat, DAT, SCSI
- * Programs available: P1 - P99
- * You can load one saved Program at a time.

1. Press the DISP SEL key to select "SETUP" ("SETUP" will flash) and press the EXECUTE/YES key. ("SETUP" will light up.)
The D-160 will enter the Setup mode.
2. Use the JOG dial to select "Load PGM?" ("?" will flash.).
3. Press the EXECUTE/YES key.
The message "Load Device?" and the type of digital signal to be loaded ("DAT," "adat," or "SCSI") will flash on the display.

- 4. Rotate the JOG dial to select the type of digital signal format to be used for the load operation.**
 Selecting "adat" will load data in the adat digital signal format.
 Selecting "DAT" will load data in the S/P DIF digital signal format.
 Select "SCSI" if you are loading data via SCSI. The following operation will be that when "adat" or "DAT" is selected for "Load Device?."

5. Press the EXECUTE/YES key. ("SURE?" flashes.)

Selection of the digital signal format for the load operation will be confirmed, and the existing Program numbers will flash on the display.

- If digital signal is being input correctly, a red "DIGITAL" indicator will light up on the display. If the red "DIGITAL" indicator flashes, check the connection, cabling, and the settings of the D-160 and the external device.

<Notes>

- * If the sampling rate of the incoming S/P DIF digital signal is different, the FS indicator in the display (44.1kHz or 48kHz) will flash to warn you.
- * Even if the sampling rate of the incoming adat signal is different, no warning will appear. Use caution when you set the sampling rate.

6. Rotate the JOG dial to select a Program into which to load data.

You can select any existing Program (from up to 99).

- If you select a Program that already contains data and execute the load operation, the existing data will be overwritten by the new data.

If you do not wish to overwrite any data in any current Program, use the JOG dial to select "New PGM" to execute the load operation. You can do this only when the number of existing Programs is 99 or less and the hard disk has enough free space to accommodate the new data.

<Note>

Once you start loading, all existing song data in the Program will be erased, even if you cancel loading during the operation, and new song data and tempo map data etc. (data up to the point at which you canceled the operation) will be recorded. For example, if you load two minutes of song data into a Program that already contains a song of six minutes, the new song data will be recorded and the old song data will be erased in its entirety. (ABS END is "two minutes.") Bear this in mind and be certain to check the Program before you execute the load operation.

7. Press the EXECUTE/YES key.

Now you can select tracks into which to load.

Use the SHUTTLE or the HOLD/> key to flash the characters, and use the JOG dial to select a desired number. Select one of the following track combinations: "1-8," "1-16," "1-24," "9-16," "17-24."

8. Press the EXECUTE/YES key. ("SURE?" flashes.)

9. Press the EXECUTE/YES key again.

"Play DAT!" (Start playing the DAT) or "Play adat!" (Start playing the adat) appears on the display.

10. Play the corresponding external device (DAT or adat).

The load operation starts when the D-160 accepts the incoming digital signal. The time required for the load operation appears on the display and starts counting down. Two tracks are loaded at a time from a DAT machine in the following order: Track 1 and 2, 3 and 4, etc. from a DAT machine. Eight tracks are loaded each time in the order of Track 1-8, 9-16, etc..

11. When the load operation is complete, "COMPLETED!" flashes on the display.

12. Press the STOP button or the EXIT/NO key to quit Setup mode.

The display will indicate the time base set for the loaded Program.

- To cancel the operation or restore the indication shown before you pressed the EXECUTE/YES key, press the STOP button or the EXIT/NO key. Pressing one of these keys repeatedly takes you to the previous layer, finally quitting Setup mode, and the display will return to the previous time base indication. If you press the STOP button or the EXIT/NO key any time after you execute the load operation but before it completes, the loaded song data will be largely invalid, though some portion may play back.

<Note>

Do not remove the optical cable or perform any other operation that would disconnect the S/P DIF signal until the session is complete. Otherwise, the D-160 will generate noise, and affect the connected device.

3. Saving the data using SCSI

SCSI devices you can use

Please use the following recommended SCSI devices that have already been performance tested.

Recommended SCSI devices that have been tested for operation (as of January '97)

| | |
|---------------------|---|
| <MO>: 230MB | LF-3200 (Matsushita) MOS331 (Olympus) M2512A (Fujitsu) |
| <MO>: 540MB | OMD-7060 (Konica)/540MB only |
| Removable hard disk | zip 100 (IOMEGA)/100MB jaz (IOMEGA)/1GB ezflyer (SyQuest)/230MB EZ135 (SyQuest)/135MB SyJet (SyQuest)/1.5GB |
| <PD> | LF-1000 (Matsushita)/640MB |
| Fixed hard disk | FireBall 1080S (Quantum)/1.08GB |

* Either disk should have SCSI-2 specifications.

<Note>

These SCSI devices have already been tested for performance at Fostex. However, any product lot includes variance in quality. The test at Fostex does not include inspection for such variance. When you use external SCSI devices, check the operation carefully. Fostex is not liable for any damage (data loss or damage) caused by using the D-160 with external SCSI devices.

* Restore the default settings on the D-160.

Connecting a SCSI device

Refer to the diagram to connect a SCSI device to a D-160.

<Notes>

- * First, turn off the power to all the devices before you connect them.
- * Connect only one SCSI device to the D-160.
You cannot chain SCSI devices. Install a SCSI terminator on the other connector. (If the SCSI device has a termination switch, be sure to turn the switch ON to terminate the device.)
- * The D-160 will detect the SCSI ID number set on the connected device, and show it on the display. (Refer to the SCSI device manual for setting the ID number.)
- * You must format the SCSI disk after you connect it to the D-160. Refer to the "Formatting" section on the next page for the formatting procedure.

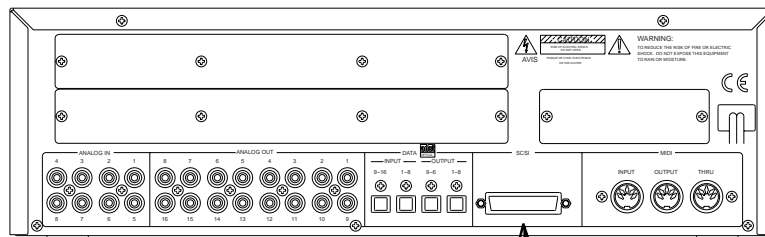

D-160

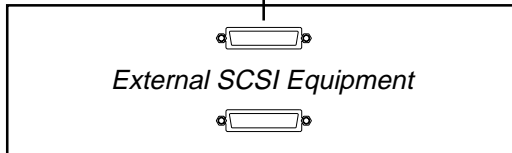

Formatting a SCSI disk

About formatting a SCSI disk:
 You will format a SCSI disk in the "Disk Format?" menu in Setup mode. During formatting, the D-160 automatically checks the performance of the connected SCSI device, selects and displays an appropriate format type from TYPE 0 - TYPE 2 (TYPE 2 is selected as a default setting). The user can manually select the desired type.

| TYPE | Available recording time | SAVE/LOAD <i>It takes the same time to save and load data using TYPE 0 and TYPE 2.</i> | Real time recording <i>You need to select the SCSI drive as the current drive.</i> | Real time playback <i>You need to select the SCSI drive as the current drive.</i> | Remarks |
|--------|---|--|--|---|--|
| TYPE 0 | <Short> <i>Depends on the disk.</i> | <Possible> | <Possible> <i>However, Fostex will not guarantee the operation. Refer to "Notes on real time recording/playback" for more information.</i> | <Possible> <i>However, Fostex will not guarantee the operation. Refer to "Notes on real time recording/playback" for more information.</i> | <i>You cannot specify TYPE 0. The measuring function of the D-160 will select this option.</i> |
| TYPE 2 | <Long> <i>Depends on the disk.</i> | <Possible> | <Not possible> <i>The D-160 will reject any attempt to set it in recording mode.</i> | <Possible but the sound will skip> | <i>We recommended that you use TYPE 2 format if you are using a SCSI drive only to save and load data.</i> |
| TYPE 3 | <Longest> <i>Depends on the disk.</i> | <Possible> <i>TYPE 3 is used to perform simple formatting. Read the notes below before proceeding with the operation.</i> <Notes> <i>* TYPE 3 format will format the disk, assuming that the entire area in the disk is available, and will not be able to identify the area actually available.</i> <i>* Bad blocks in the disk cannot be selected. This may later cause the sound to skip.</i> | <Not possible> <i>The D-160 will reject any attempt to set it in recording mode.</i> | <i>The degree of sound skipping will depend on the result of automatic measurement with TYPE 0 and 2.</i> TYPE 0: Skip -> less TYPE 2: Skip -> frequent | <i>The merit of TYPE 3 is that a shorter formatting time is required, compared to TYPEs 0 and 2. For example, if you are using an MO disk that has already been formatted for DOS or MAC, usually there are no bad blocks on the disk. Using TYPE 3 format will be quicker than TYPEs 0 and 2. The D-160 will not select this type using the measuring function. Only users can specify this type.</i> |

<Notes on real time recording and playback>
 Logically, you can perform real time recording/playback if your case is described under the <Possible> category in the table shown on the above. However, the sound might skip, depending on the condition of the connected SCSI drive disk.
 The D-160 performs experimental reading and writing at two points on the disk to measure the performance of the connected SCSI device, and based on the results, such as the response time of the disk, it will determine the format type (TYPE 0-2). Therefore, for parts of the disk other than the two measured points, you do not know if the disk will maintain adequate speed to realize real time recording/playback.
 It might be possible that the sound skips during real time recording or playback within the untested parts. Measuring two points for performance can indicate tell whether or not the disk is reliable, but this is only an "index." Fostex will not guarantee the operation of the SCSI disk.

Although the following chart presents the SCSI disk formatting time in accordance to each format type (measured by Fostex), please refer to this, as necessary, only for an approximate formatting time.

| | Formatting Time | |
|-----------------|-----------------------|--------------------|
| | TYPE 0, 2 | TYPE 3 |
| SyJet (1.5GB) | Approx. 20 minutes | Approx. 5 seconds |
| FireBall (1GB) | Approx. 16 minutes | Approx. 5 seconds |
| PD (640MB) | Approx. 50 minutes | Approx. 22 seconds |
| MO (230MB) | Approx. 12~15 minutes | Approx. 27 seconds |
| MO (540MB) | Approx. 14~17 minutes | Approx. 22 seconds |
| EZ135 (135MB) | Approx. 3 minutes | Approx. 4 seconds |
| ezflyer (230MB) | Approx. 6 minutes | Approx. 5 seconds |
| zip (100MB) | Approx. 4 minutes | Approx. 8 seconds |
| jaz (1GB) | Approx. 15 minutes | Approx. 5 seconds |

1. Connect the SCSI device to the D-160 and turn the power on to the both machines.

2. If you are using a removable disk, insert the disk into the drive.

To remove the inserted disk, press the STOP button and the EXIT/NO key on the D-160 simultaneously.

You cannot remove the disk from the SCSI device.

3. Press the DISP SEL key to select the Setup mode, and press the EXECUTE/YES key.

The Setup mode menu appear on the display.

4. Turn the JOG dial to select "Disk Format?" ("?" flashes), and press the EXECUTE/YES key again. "Disk Format IDE" ("IDE" flashes) appears.

CAUTION: If format is executed while "IDE" is blinking, the internal IDE hard disk will be formatted and data in the IDE hard disk will be lost.

5. Rotate the JOG dial to display the flashing "SCSI" and press the EXECUTE/YES key. The ID number and name of the connected SCSI device appear on the display, and "?" and "SURE?" flash.

6. Press the EXECUTE/YES key.

The D-160 indicates "Please Wait!" followed by the results of a performance measurement of the connected SCSI device, and flashes an appropriate format type and the message "SURE?".

7. Press the EXECUTE/YES key.

"REMAIN" lights up and formatting starts.

As the formatting operation progresses, the size of the area to be formatted on the disk will count down on the display. (For example, indication "-125MB" will count down to "0MB".)

Also, when the formatting operation starts, all the FL indicators (for Tracks 1-16) at level ∞ of the level meters light up. As the formatting operation progresses, these indicators will be turned off from Track 16. This condition indicates that the disk is being formatted correctly.

When formatting is complete, "COMPLETED!" will appears and all the FL indicators will turn off.

8. Press the EXIT/NO key or the STOP button to quit the Setup mode.

The D-160 returns to the ABS display of the Program that was selected before it entered Setup mode.

In addition to the formatting procedure mentioned above, you can also use the following steps to format an unformatted disk.

Install an unformatted fixed disk or removable disk, and go to the "2-21. Drive Sel.?" menu in Setup mode. Change the current drive from "IDE" to "SCSI".

The D-160 will recognize that the SCSI disk is not formatted and automatically enter the "2-24. Disk Format ?" menu in Setup mode, where you can follow the procedure mentioned above to format the disk.

Name of data saved in the SCSI disk:

The D-160 manages data in the internal IDE hard disk using the name "Program" (such as Program 1, Program 2, etc. which appears on the display as P01, P02, etc.). Data on the SCSI disk is termed "Song" or "Backup" to differentiate it from Program data.

When you format a SCSI disk, Song #1 is created on the disk. When you switch the current drive from "IDE" to "SCSI," the D-160 will display "S01."

When you save data from the D-160 to the SCSI disk, the data is treated as "Song" or "Backup," depending on how you saved the data.

| How to save data | Name | Display |
|--|--------|---------|
| When one or all Programs were saved to one fixed disk or removable disk. | Song | "S**" |
| When one Program was saved to multiple removable disks. | Backup | "B**" |

<Note>
You can use multiple removable disks, but not multiple fixed disks to save data.

Saving data of an individual Program

You will use the "Save PGM ?" menu in Setup mode.

- * Input format available: adat, DAT, SCSI
- * Programs available: P1 - P99, ALL
- * You can save one Program or all Programs at once.

1. Press the DISP SEL key to select "SETUP" ("SETUP" will flash), and then press the EXECUTE/YES key. ("SETUP" will light up.)

The D-160 will enter the Setup mode.

2. Use the JOG dial to select "Save PGM?" ("?" will flash.).

3. Press the EXECUTE/YES key. ("SAVE" lights up.)

The indication of the type of digital signal to be saved will flash on the display.



4. Rotate the JOG dial to select a flashing "SCSI."

5. Press the EXECUTE/YES key. ("SURE?" flashes.)

The external digital device is set to "SCSI," and the existing Program numbers will flash on the display. (e.g.: "P02 [current title..." with "02" flashing.)

6. Rotate the JOG dial to select a Program to save.

You can select any existing Program individually or all Programs (Save All). (Refer to the next section for information on saving all Programs.)

As mentioned previously, the display indication differs as follows depending on whether the selected Program to save requires only one removable disk or multiple disks.

*** If you have selected a Program that has only the Program number and title indication on the display:**

e.g.: **P02 [#******* (#***** is current title)

This indication means that saving Program P02 requires only one SCSI fixed or removable disk.

*** If you have selected a Program that has the Program number and title indication, plus "nD" (n=number) on the display:**

e.g.: **P01[*****]2D** (***** is title)

This indication means that saving Program 01 requires multiple SCSI disks.

"2D" in this example means that two disks are required.

When using the hard disk, if the program data to be saved is larger than the hard disk capacity, "- ***MB" (insufficient capacity) will be displayed.

Also, if the EXECUTE/YES key is pressed while this is on the display, "DISK FULL" will appear in the display.

7. Press the EXECUTE/YES key. ("SURE?" flashes.)

The D-160 performs the save operation differently depending on the selected Program.

*** If you have selected a Program that requires only one disk to save:**

The current Song number ("S01") in the SCSI disk appears on the display.

Pressing the EXECUTE/YES key at this point will start the save operation. "REMAIN" will light up, then the D-160 will display "P01>>S01-***MB". "-***MB" indicates the remaining amount of data to be saved, which will count down as the save operation is in progress.

*** If you have selected a Program that requires multiple disks:**

The save operation will start right away. "REMAIN" will light up, then the D-160 will display "P01>>B01-***MB". (The indication of the remaining amount of data to be saved will count down as the save operation is in progress.) The Song number will automatically change to the Backup number "B01."

When saving to the first disk is complete, "Insert Disk 2" (Insert the second disk!) appears on the display, and the D-160 will automatically eject the disk. When you insert the second disk, the D-160 will continue the save operation with the same Backup number. In this way, when the entire save operation is complete, the D-160 will display an illuminated "COMPLETED!", then change to the Time Base of the saved Program.

Pressing the STOP button or the EXIT/NO key will turn the "COMPLETED!" indication off.

<Notes>

- * You cannot abort a save operation on the SCSI device while it is in progress.
- * To enter a title for a SCSI disk, go to "2-20. Drive Sel.?" menu in Setup mode and change the current drive to "SCSI," and then go to "2-4. Title Edit?" menu in Setup mode to enter the title. Normally, the title of the program in the internal IDE hard disk will be directly copied as the title of the song in the SCSI disk or the title of the backup data.
- * If you try to save data to multiple disks or try to save all Program data to one disk, and if those disks already have data recorded, the message ("B01[*****]DEL" or "S01[*****]DEL") will appear on the display, asking if you wish to erase the Backup data or Song data already recorded on the disk, and "SURE?" will flash. Subsequently, if you wish to erase the data, press the EXECUTE/YES key and save will start after erasing the data. If you do not want to erase the data, rotate the JOG dial and select "Eject" while "SURE?" is blinking, and then press the EXECUTE/YES key and remove the disk. The disk can also be removed after emerging from the SETUP mode by pressing the STOP button or the EXIT/NO key. In this case, press the EXIT/NO key while pressing down on the STOP button when in other than the SETUP mode.

Saving all Programs (Save ALL)

1. Follow Steps 1 through 5 of the "Saving an individual Program" procedure.
2. Use the JOG dial to select "Save ALL?" ("?" flashes.)

Selecting "Save All?" will cause the following display to appear.

Save All? (nn/nn) (nn=number)

The number on the right of the slash (/) is the number of all Programs, and the number on the left is the number of Programs that can be saved.

For example, "03/03" means that all three Programs can be saved. "01/03" means that one Program out of three Programs can be saved.

"00/03" means that no Programs can be saved. If you press the EXECUTE/YES key at this point, "Void Command!" appears and you cannot proceed with the save operation.

If you have selected "Save All", you cannot use multiple disks to save. In this case, choose the save operation for an individual Program.

3. Press the EXECUTE/YES key ("SAVE" light up.)

Data will be saved as Song data. Therefore, Program 1 (P1) on the internal hard disk will be saved as Song 1 (S1), Program 2 (P2) as Song 2 (S2).

After the save operation is complete, "COMPLETED!" lights up. Press the STOP button or the EXIT/NO key to return to the previous Time Base display.

<Notes>

- * You cannot abort a save operation while it is in progress.
- * To enter title for a SCSI disk, go to "2-20. Drive Sel.?" menu in Setup mode and change the current drive to "SCSI," then go to "2-4. Title Edit?" menu in Setup mode to enter the title.

<Note>

If an error occurs during execution of save and "Error 35" appears in the display, carry out the following steps:

1. Press the EXIT/NO key.
"Retry?" will appear in the display.
2. If save is to be executed again, press the EXECUTE/YES key upon display of "Retry?." Save will be executed again.
If ALL save was carried out in this process, save will be executed again from where the error occurred. Also, if several disks are used for the save, it will save again from the head of the disk in which the error occurred.
3. If it is to be canceled without executing save, press the EXIT/NO key upon display of "Retry?."

Loading Song data

Use the "Load PGM?" menu in the Setup mode to load Song data.

- * Input format available: adat, DAT, SCSI
- * Programs available: P1 - P99, ALL
- * You can save one Program or all Programs at a time.

1. Press the DISP SEL key to select "SETUP" ("SETUP" will flash) and press the EXECUTE/YES key. ("SETUP" will light up.)

The D-160 will enter the Setup mode.

2. Use the JOG dial to select "Load PGM?" ("?" will flash.)

3. Press the EXECUTE/YES key. ("LOAD" will light.)

An indication of the type of the digital signal to be loaded will flash on the display.



4. Rotate the JOG dial to select a flashing "SCSI."

5. Press the EXECUTE/YES key.

The external digital device is set to "SCSI," and the existing Song numbers will flash on the display. (i.g.: "S01[******]" with "01" flashing.)

6. Rotate the JOG dial to select the data to load.

You can choose to load any existing Song individually or all Songs collectively.

The display indication differs as follows depending on whether you selected an individual Song number or all Song numbers.

*** If you have selected an individual Song:**

e.g.: You have selected Song 2.

S02[***** (***** is title)

*** If you have selected all Songs:**

e.g.: **Load ALL (**/**)** (**=**)

7. Press the EXECUTE/YES key. ("SURE?" flashes.)

Now you can select a Program to load data into.

*** If you have selected an individual Song number:**

The D-160 will indicate the destination Program number on the internal hard disk. Use the JOG dial to select a desired destination Program number into which to load data.

If you select a destination Program that already has data, pressing the EXECUTE/YES key will execute the load operation and the loaded data will overwrite the existing data in the Program. If you do not want to overwrite the existing data, use the JOG dial to select "New PGM."

*** If you have selected "Load All?(**/**):**

The D-160 will indicate the destination Program number on the internal hard disk. Use the JOG dial to select a desired destination Program number into which to load data.

If the destination hard disk already contains data and you select a Program, "DEL" (Delete) appears following the Program number.

This is because the "Load All" operation will first erase any Program data on the disk before loading Song data.

Pressing the EXECUTE/YES key at this point will cause "Delete All PGM?" (deleting all Programs) to appear, and then "SURE?" will flash.

8. Press the EXECUTE/YES key.

Song data will be loaded to the selected Program.

For example, if Song 1 (S01) is loaded into Program 1 (P01), the D-160 will display "S01>>P01-***MB" and "REMAIN" will light up. The remaining data to be loaded will count down on the display as the load operation progresses.

During the all Program load operation, Songs are loaded into Programs sequentially; that is, Song 1 into Program 1, Song 2 into Program 2. (The display changes will correspond to this sequence: "S01>>P01-***" → "S02>>P02-***", etc.)

When the load operation is complete, "COMPLETED!" will light and the D-160 will display the Time Base that was shown before the unit entered the Setup mode.

9. Press the STOP button or the EXECUTE/YES key, and "COMPLETED!" will turn off.

<Notes>

- * You cannot abort a load operation on a SCSI device while it is in progress.
- * To enter a title for the SCSI disk, go to "2-20. Drive Sel.?" menu in Setup mode and change the current drive to "SCSI," then go to "2-4. Title Edit?" menu in Setup mode to enter the title.

Loading Backup data

As an example here, we will load the data of a Program saved onto two removable disks.

- 1. Insert the first disk (Disk-1) into the SCSI device.**
- 2. Follow Steps 1-4 of the "Loading Song data" procedure.**
- 3. Select "SCSI" and press the EXECUTE/YES key. ("LOAD" lights up).**

The external digital device is set to "SCSI". The display flashes the number of the existing Backup data in the SCSI disk, and then indicates that the first disk has been inserted.

B01[***]D1** (***** = current title, D1 = Disk-1)

Rotating the JOG dial will toggle between "B01" and "Eject."

If you wish to cancel the load operation and remove the disk, select "Eject" and press the EXECUTE/YES key.

- 4. While "B01[*****]D1 appears on the display, press the EXECUTE/YES key. ("SURE?" flashes).**
The current Program number flashes and you can select the load destination Program.

P01[***]** (***** = current title)

- 5. Use the JOG dial to select a Program into which to load data. ("SURE?" flashes.)**

If you select a Program that already contains data and execute the load operation, that existing data will be overwritten by the new data. If you do not wish to overwrite data in the Program, use the JOG dial to select "New PGM" to execute the load operation.

- 6. Press the EXECUTE/YES key. ("REMAIN" and "LOAD" light up.)**

Load operation will start, and the D-160 will display "B01>>P01 -***MB."

This means that Backup 1 (B01) data in the SCSI disk is being loaded into Program 1 (P01) on the internal hard disk. As the operation progresses, the number "-***MB" (remaining data amount to be loaded) will count down. When loading from the first disk is complete, the message "Insert Disk2" appears and the first disk is automatically ejected.

- 7. Insert the second disk into the SCSI device.**

Loading from the second disk automatically starts. The display and count down are the same as those for the first disk.

After all data is loaded, "COMPLETED!" lights up, and Time Base of the destination Program will be located. Press the STOP button or the EXIT/NO key, and "COMPLETED!" will turn off.

<Notes>

- * You cannot abort a load operation on a SCSI device while it is in progress.
- * To enter a title for the SCSI disk, go to "2-20. Drive Sel.?" menu in the Setup mode and change the current drive to "SCSI," then go to "2-4. Title Edit?" menu in the Setup mode to enter the title.

<Note>

If an error occurs during execution of load and "Error 36" appears in the display, carry out the following steps:

- 1.** Press the EXIT/NO key.
"Retry?" will appear in the display.
- 2.** If load is to be executed again, press the EXECUTE/YES key upon display of "Retry?."
Load will be executed again.
If ALL load was carried out in this process, load will be executed again from where the error occurred. Also, if several disks are used for the load, it will load again from head of the disk in which the error occurred.
- 3.** If it is to be canceled without executing load, press the EXIT/NO key upon display of "Retry?."

4. Compatibility with D-90, D-80 V2.0, DMT-8 V2.0, and DMT-8

"FDMS-3 (Fostex Disk Management System-3)" for recording format of the D-160, and "FDIO-1 Ver2.0 (Fostex Data In/Out-1 Ver2.0)" for save/load format of song data, are employed. In the D-90, "FDMS-2 Ver2.0" and "FDIO-1 Ver2.0," in the D-80/D-80 Ver2.0 and DMT-8VL, "FDMS-2" and "FDIO-1", furthermore, in the DMT-8, "FDMS-1" and "FDIO-1," respectively, are employed.

Due to these conditions, the hard disk recorded in the D-160 cannot be installed and used in another equipment. However, as the save/load format is same for the D-160 and D-90, data saved from the D-160 to an external digital equipment (adat or DAT) can be loaded in 8 track units to the D-90 or data saved in the D-90 can be loaded in D-160. Refer to list below for functional comparison of each product.

During save/load using DAT and Adat, independent save/load in 8 track units is possible. In this case, the data in 8 track units are not distinguished as tracks 1~8 or 9~16 but simply handled as eight track data. Therefore, because this 8 track data is compatible with the D-90 if it is in 8 track units (any one combination of 1~8, 9~16 or 17~24), data saved from the D-160 can be loaded in tracks 1~8 of the D-90. In this case, data in the tracks which were not loaded will remain intact.

| | D-160 | D-90 | D-80 V2.0 DMT-8V2.0 DMT-8VL | DMT-8 |
|--|---|---|---|---|
| Program | 99 (P1~P99) | 9 (P1~P9) | 5 (P1~P5) | 1 (P1) |
| Editing the memory data | 00: 00: 00: 00: 00 ~ 23: 59: 59: 29: 59 | 00: 00: 00: 00: 00 ~ 23: 59: 59: 29: 59 | 00: 00: 00: 00: 00 ~ 06: 00: 00: 00: 00 | 00: 00: 00: 00: 00 ~ 06: 00: 00: 00: 00 |
| Setting of the time base | ○ | ○ | ○ | ○ |
| Backup of the time memory | ○ | ○ | × | × |
| SETUP mode | | | | |
| Sampling frequency | 44.1/48kHz | 44.1/48kHz | 44.1kHz | 44.1kHz |
| Setting of the time signature | ○ (64 points) | ○ (64 points) | ○ (64 points) | ○ (16 points) |
| Setting of the tempo | ○ (64 points) | ○ (64 points) | ○ (64 points) | ○ (32 points) |
| Metronome function | ○ | ○ | ○ | ○ |
| Loading/Saving the song data | adat, S/P DIF, SCSI (P1~P99) | adat, S/P DIF (P1~P9) | S/P DIF (P1~P5) | S/P DIF (P1) |
| Setting of the preroll time | ○ | ○ | ○ | ○ |
| Setting of MIDI sync output signal | ○ | ○ | ○ | ○ |
| Setting of the MTC frame rate | ○ | ○ | ○ | ○ |
| Setting of the MTC offset time | 00: 00: 00: 00: 00 ~ 23: 59: 59: 29: 59 | 00: 00: 00: 00: 00 ~ 23: 59: 59: 29: 59 | 00: 00: 00: 00: 00 ~ 06: 00: 00: 00: 00 | 00: 00: 00: 00: 00 ~ 06: 00: 00: 00: 00 |
| Setting of the MTC offset mode | ○ | ○ | × | × |
| Setting of the Rec protect | ○ | ○ | ○ | ○ |
| Setting of the digital input track | ○ (adat, S/P DIF) | ○ (adat, S/P DIF) | ○ (S/P DIF) | × |
| Setting of the digital output track | ○ (adat, S/P DIF) | ○ (adat, S/P DIF) | ○ (S/P DIF) | × |
| Setting of the bar/beat resolution mode | ○ | ○ | ○ | × |
| Setting of the slave mode | ○ | ○ | ○ | × |
| Setting of the slave type | ○ | ○ | × | × |
| Setting of the MIDI device ID | ○ | ○ | ○ | × |
| Setting of the Undo function | ○ | ○ | ○ | × |

MIDI sync function

The following are examples concerning general types of systems using MIDI related functions contained in the D-160.

1. MIDI clock sync system

By setting any desired meter at any desired point of the programmable tempo map contained in the D-160, and by output of a MIDI clock and song position pointer according to the setting, a hardware type MIDI sequencer can be synchronized as a MIDI clock slave. Consequently, in this system, the D-160 will be the master and the MIDI sequencer the slave.

Unlike conventional tape type MTR, all sixteen tracks can be fully utilized without wasting one track on a sync signal.

- * Restore the default settings on D-160.
- * Check for the correct program and proper sampling frequency.

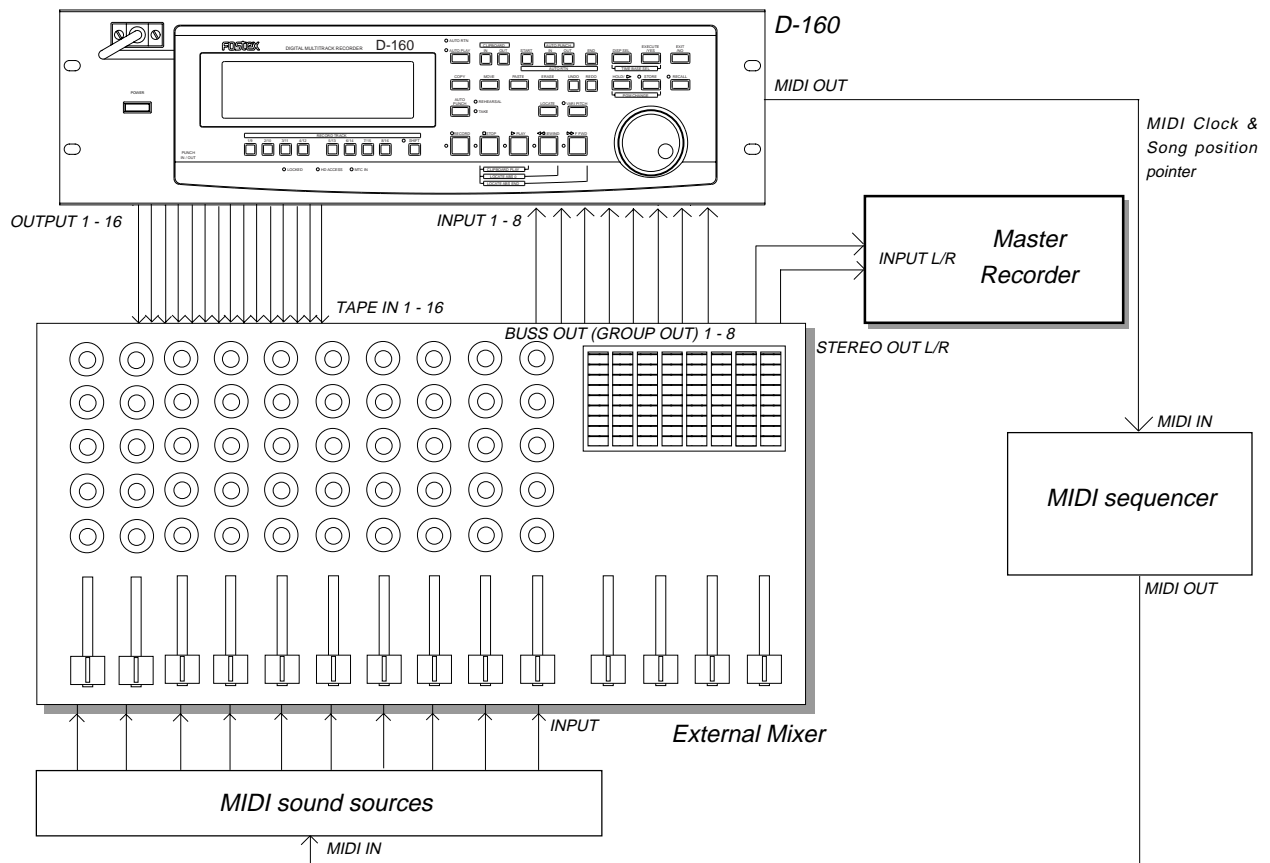

Connecting external equipment (Refer to connecting schematic)

1. Connect the D-160 MIDI OUT to MIDI IN of the MIDI sequencer.
2. Set the MIDI sequencer for "external sync mode (EXTERNAL SYNC) by MIDI clock."

* Refer to the Owners Manual of the equipment in use for details.

Setup of D-160

1. Because the MIDI clock and song position pointer will be output from the D-160, set the SETUP mode "MIDI sync signal output setting" to "CLK."

- * Initial setting: CLK
- * Permissible setting: CLK (MIDI clock and song position pointer:"CLK") / MTC (MIDI time code: "MTC") / Off (No output of MIDI sync signal)
- * This item can be setup for each program.
- * The setting can be saved/loaded as song data.
- * This setting will be held even though power is switched OFF.

Refer to page "150", SETUP mode "2-8. MIDI sync signal output setting" for correct operating procedures.

2. The meter in the desired bar can be set by "Time signature setting" of the SETUP mode.

- * Initial setting: 001 bar, 4/4 signature.
- * Permissible bar setting: 001~999
- * Permissible meter setting: 1/4, 2/4, 3/4, 4/4, 5/4, 1/8, 3/8, 5/8, 6/8, 7/8, 8/8, -- -- (Elimination of signature)
- * Permissible setting of maximum number of points: 64 points
- * This item can be set for each program.
- * The setting can be saved/loaded as song data.
- * This setting will be held even though power is switched OFF.

Refer to page "143", SETUP mode "2-2. Time Signature Setting" for operating procedure.

3. Tempo in the desired bar can be set by "Tempo setting" of the SETUP mode.

Tempo map is made in steps 2 and 3.

- * Initial setting: 001 bar, 1st meter, Tempo120.
- * Permissible bar setting: Follows the previous "Setup of the time signature."
- * Permissible signature setting: Follows the previous "Setup of the time signature."
- * Permissible setting of tempo: Quarter note=30~250 (Tempo elimination)
- * Permissible setting of maximum number of points: 64 points
- * This item can be set for each program.
- * The setting can be saved/loaded as song data.
- * This setting will be held even though power is switched OFF.

Refer to page "145", SETUP mode "2-3. Tempo Setting" for operating procedure.

4. Set the SETUP mode "Metronome setting" to ON if click sound is to be output according to the setup tempo map.

- * Initial setting: Off
- * Permissible setup item: Off, On
- * This item can be set for each program.
- * The setting can be saved/loaded as song data.
- * This setting will be held even though power is switched OFF.

Refer to page "148", SETUP mode "2-6. Metronome setting" for operating procedure.

5. Press the DISP SEL key while pressing the EXECUTE/YES key, and then change the time base display to BAR/BEAT/CLK.

Confirming the MIDI clock sync

During recording and at playback following the recording, the time base (BAR/BEAT/CLK) is displayed in accordance to the setup tempo map, and the MIDI clock and song position pointer is also output.

Confirm that the travel position (BAR/BEAT/CLK) of the D-160 and the travel position of the synchronized MIDI sequencer are matched.

** If correct sync cannot be obtained, re-check the connections/cables and setting of both equipment.*

<Note>

In the D-160, the "ABS 0" position is set at "002BAR/1BEAT /00CLK."

This setting is made in consideration of the time required (it will not sync immediately) for the MIDI sequencer, etc. to enter into sync.

As a result, if the D-160 is played back from ABS 0 (LOCATE ABS 0), sync will be completed by the time it reaches the first bar, and will thus synchronize from head of the tune.

Execution of recording

Various ways of recording can be conducted while synchronizing the D-160 and the MIDI sequencer with the MIDI clock.

2. MTC sync/MIDI machine control system

The following will explain synchronization by the MTC (MIDI time code) output and the computer controlling system using MMC (MIDI machine control). In this system, the D-160 will be the master and the computer (with sequence software) will be the slave.

The D-160 will attach any desired offset (time difference) against ABS time (absolute time) and output it as MTC in any desired frame rate.

It can also carry out the proper operation upon receiving an MMC and Fostex System Exclusive Message from outside. In this case, because the D-160 can setup a DEVICE ID number by the SETUP mode "2-18. MIDI Device ID Setting" menu, a multiple number of D-160's can be separately controlled by changing the DEVICE ID numbers in the transmitted message from the computer.

In regards to the corresponding content for MMC, refer to the "MMC list" on page "173" and on the Fostex System Exclusive Message, the "Fostex Exclusive List" on page "174."

- * Set D-160 in the initial state.
- * Confirm the program and sampling frequency.

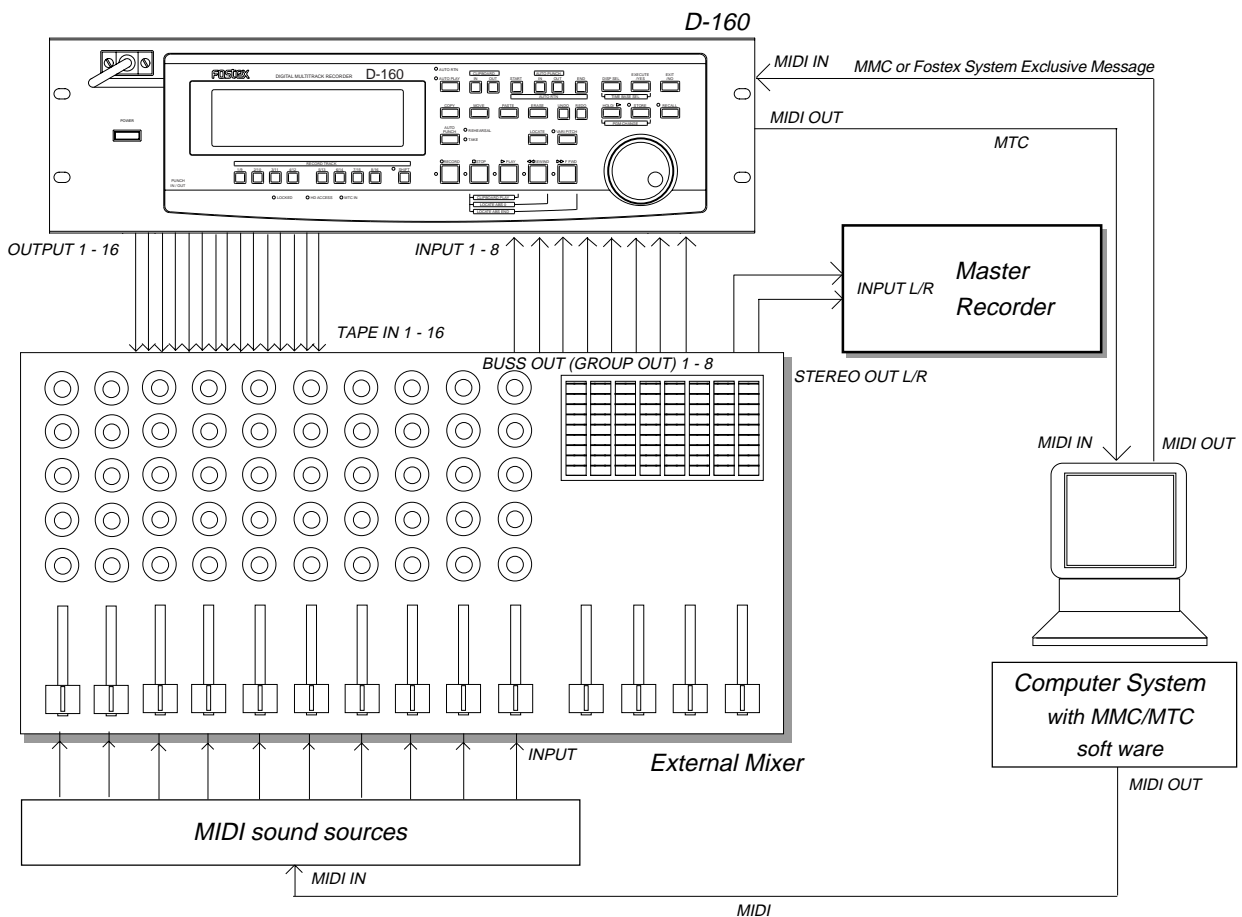

Connecting to external equipment

Connect the D-160 MIDI IN/OUT to the computer (with MIDI interface) MIDI IN/OUT (MMC/MTC complied sequence software is activated in the computer).

Setup of external equipment

Setup the following in the sequence software.

- * Set to MTC external sync mode (EXTERNAL SYNC).
- * Set for output of MMC.
- * Set to the desired MTC read out frame rate.
- * Set start time of the tune (which MTC time is to be the first bar). Refer to precaution in regards to MTC offset, farther on.

For details, refer to Owners Manual of the external equipment.

Setup of D-160

1. Because MTC will be output from D-160, set to "MTC" the SETUP mode "MIDI sync signal output setting."

Refer to page "150", SETUP mode "2-8. MIDI sync signal output setting" for operating procedure.

2. Set a random offset time by the SETUP mode "MTC offset time setting."

- * Initial setting: 00h (Hour) 59m (Minute) 57s (Second) 00f (Frame) 00sf (Sub Frame)
- * Permissible setup time: 00h 00m 00s 00f 00sf ~ 23h 59m 59s 29f 99sf
- * This item can be set for each program.
- * The setting can be saved/loaded as song data.
- * This setting will be held even though power is switched OFF.

Refer to page "152", SETUP mode "2-10. MTC offset time setting" for operating procedure.

3. In the SETUP mode "MTC offset mode setting," whether the MTC offset time setup in Step 2 should be output (ABS) at the ABS 00m 00s 00f 00sf position or at the 001BAR 1BEAT 00CLK (bar, signature) must be selected.

- * Initial setting: ABS
- * Permissible setup item: ABS, Bar ↓
- * This item can be setup for each program.
- * The setting can be saved/loaded as song data.
- * This setting will be held even though power is switched OFF.

Refer to page "153", SETUP mode "2-11. MTC offset mode setting" for operating procedure.

4. Setup to the same frame rate as that setup by the sequence software by "MTC Frame rate setting" of the SETUP mode.

- * Initial setting: 25 frames
- * Permissible setup of frame rate: 24, 25, 29nd, 29df, 30nd, 30df
- * This item can be setup for each program.
- * The setting can be saved/loaded as song data.
- * This setting will be held even though power is switched OFF.

Refer to page "151", SETUP mode "2-9. MTC Frame rate setting" for operating procedure and details.

5. Set to the same figure as the sequence software MMC device number (and Fostex System Exclusive Message device number) by the SETUP mode "MIDI device ID setting."

When the sequence software transmits by "7F," it means "ALL DEVICE" and therefore, it need not be setup. The D-160 transmitting device ID will also function in parallel with this setting.

- * Initial setting: 00
- * Permissible setup ID: 00 ~ 99
- * This item will be the setting common to all programs.
- * This setting cannot be saved/loaded as song data.
- * This setting will be held even though power is switched OFF.

Refer to page "161", SETUP mode "2-18. MIDI device ID setting" for operating procedure and details.

6. Press the DISP SEL key while pressing the EXECUTE/YES key to show time base in the MTC display.

<Notes on MTC related setups>

By "MTC offset time setting" and "MTC offset mode setting," at what position (ABS 0 or 001BAR/1BEAT/00CLK) should the setup MTC (MTC offset time) is to be output is set. When setting the start time of the tune in the sequence software by these setups, be careful of the following points.

*** Offset mode: For ABS**

If playback is started from ABS 0, since MTC will be output starting from the MTC offset time that has been set, the start time of the tune set by the sequence software must be set about 3 seconds later from the MTC offset time that was setup. This will provide time because the sequence software cannot sync immediately after MTC is output. For example, if the initial setting of 00h 59m 57s 00f 00sf" is used, set the start time of the tune to "01h 00m 00s 00f." If playback is thus started from ABS 0 (LOCATE ABS 0), sync will be obtained by the time it reaches the first bar and therefore it can be made to sync from the head of the tune.

*** Offset mode: For BAR**

As mentioned before, because the "ABS 0" position is set at the "002BAR / 1BEAT / 00CLK" position, the setup MTC offset time can be set to the head of the tune without taking into account the time until reaching sync, as mentioned above. The length of the time two bars beforehand will change in accordance to the first bar setting for "signature" and "tempo." For example, it will be long if the tempo is set slow. This mode can be effectively applied when using the MIDI clock and MTC in parallel, and when using MTC for the sync signal while controlling the D-160 with time base BAR/BEAT/CLK.

Confirming MTC sync/MMC

1. During recording and at playback after recording, time base MTC is displayed according to the setting and MTC is output at the same time.

Check that the D-160 traveling position (MTC) and the traveling position of the sequence software in sync are matched.

2. Send MMC commands such as PLAY, STOP and LOCATE from the sequence software to see that the D-160 will be properly controlled.

When a correct MIDI command (MMC or FEX) is received, "MIDI" in the display will be lit for about 40msec. There is no setting in the D-160 to receive MMC or FEX but it will operate if a correct MIDI signal is input.

- * If sync and control cannot be done correctly, re-check connections/cables and the setting of both equipment.

Execution of recording

Carry out various recordings while synchronizing a D-160 and a MIDI sequencer with the MIDI clock.

3. Multitrack system by the slave mode

The following will explain an example of constructing a 48 track system using three D-160's and its slave mode functions.

- * Initialize D-160.
- * Confirm the program.
- * Set all three D-160's to the same sampling frequency.

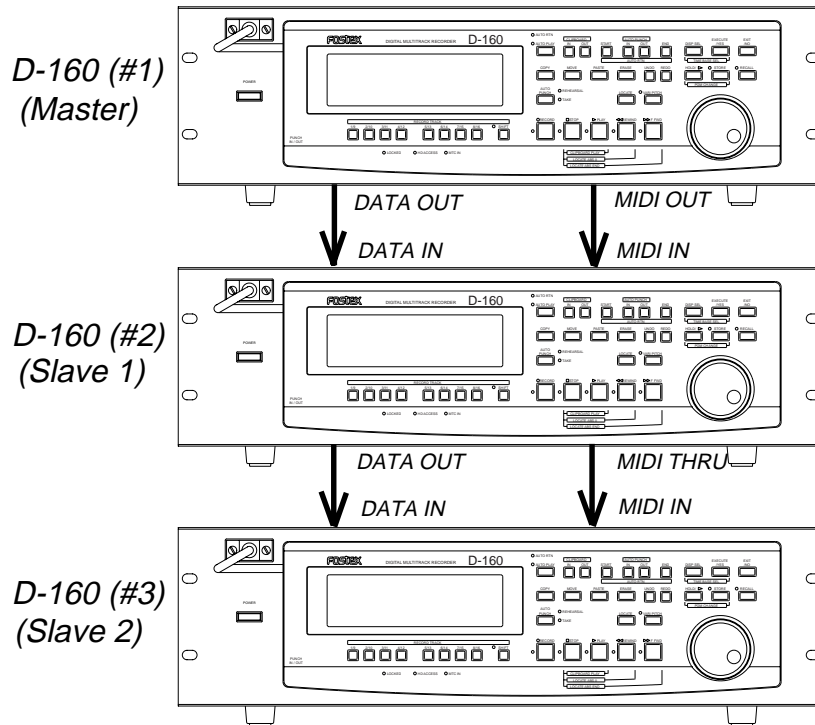

Equipment interconnections

1. From D-160 (#1) to D-160 (#2), connect DATA OUT to DATA IN and MIDI OUT to MIDI IN.
2. From D-160 (#2) to D-160 (#3), connect DATA OUT to DATA IN and MIDI THRU (Note!!!) to MIDI IN.

<Note>

In order to slave drive a D-160 with each other, the best setting is to supply Adat digital signals together with MTC from the master.

Setup of D-160 (#1)

1. Because MTC, which is the reference for sync, is output from D-160 (#1), set the "MIDI sync signal output setting" of the SETUP mode to "MTC."

Refer to page "150", SETUP mode "2-8. MIDI sync signal output setting" for operating procedure and details.

2. A random frame rate to be used is set by the SETUP mode "MTC Frame rate setting."

Refer to page "151", SETUP mode "2-9. MTC Frame rate setting" for operating procedure and details.

3. With the SETUP mode "MTC offset mode setting," whether the MTC offset time will be output (ABS) at the ABS 00h 00s 00f 00sf point or at the 001BAR 1BEAT 00CLK (bar/signature) point of the tempo map, is selected.

Refer to page "153", SETUP mode "2-11. MTC offset mode setting" for operating procedure and details.

4. A random offset time is set by the SETUP mode "MTC offset time setting."

Refer to page "152", SETUP mode "2-10. MTC offset time setting" for operating procedure and details.

5. "00" is set with the SETUP mode "MIDI device ID setting."

Refer to page "161", SETUP mode "2-18. MIDI device ID setting" for operating procedure and details.

6. Set to "adat" the digital signal to be output by the SETUP mode "Digital output track setting."

Refer to page "159", SETUP mode "2-16. Digital output track setting" for operating procedure and details.

7. Press the DISP SEL key while pressing the EXECUTE/YES key to change the time base display to MTC.

Setup of D-160 (#2) (Slave 1) and D-160 (#3) (Slave 2)

1. Set the SETUP mode "MTC Frame rate setting" to the same frame rate as in D-160 (#1).

* Refer to page "151", SETUP mode "2-9. MTC Frame rate setting" for operating procedure and details.

2. Set the SETUP mode "MTC offset mode setting" to the same mode as in D-160 (#1).

Refer to page "153", SETUP mode "2-11. MTC offset mode setting" for operating procedure and details.

3. Set the SETUP mode "MTC offset time setting" to the same offset time as in D-160 (#1).

Refer to page "152", SETUP mode "2-10. MTC offset time setting" for operating procedure and details.

4. Set the SETUP mode "MIDI device ID setting," to "01" in D-160 (#2), and to "02" in D-160 (#3).

Refer to page "161", SETUP mode "2-18. MIDI device ID setting" for operating procedure and details.

5. Using the SETUP mode "Slave mode setting," set slave mode to "On," and the SETUP mode "Slave mode type setting," the slave type to "adat."

- * Slave mode initial setting: Off
- * Permissible setup item: On, Off
- * Slave type initial setting: SP DIF
- * Permissible setup item: Vari, SP DIF, adat, Free
- * This item can be set for each program.
- * The setting can be saved/loaded as song data.
- * This setting will be held even though power is switched OFF.

Refer to page "154", SETUP mode "2-12. Slave mode setting", and to page "155", SETUP mode "2-13. Save mode type setting", for operating procedure and details.

6. Press the DISP SEL key while pressing the EXECUTE/YES key to change the time base display to MTC.

<Note>

After this setup, check the following in D-160 (#2) and D-160 (#3).

* **Blinking of "CHASE" in the display:**

This will change to constant lit upon completing chase lock in later operation.

* **"DIGITAL" is lit in the display:**

This means it is externally synchronized against the input digital signal.

<Note>

Do not insert or remove the optical cable connected to DATA IN when the slave mode is set to "On." Doing so could generate noise and affect external equipment.

Check chase lock

1. When the master unit (D-160 (#1)) is played back, MTC IN LED of the slave unit (D-160 (#2) and D-160 (#3)) will be lit, "CHASE" in the display will immediately change from blinking to lit and chase lock will be completed.
Check that the MTC time on display are same in both master and slave units.
2. When the master starts recording, the slave will also start recording upon completing chase lock.
3. When the master is stopped, the slave will also stop as MTC from the master will be interrupted. "CHASE" in the display will change from lit to blinking.
4. During FF/REW, the master only will be in the FF/REW mode and the slaves will remain stopped but when playback/recording is started, the slaves will immediately chase lock.

<Note>

The D-160 re-chase window is fixed at "10 frame." In other words, when MTC of the master and slave drifts apart more than 10 frames, it will assume that chase lock is disengaged and the slave will match the position again with the master (re-chase operation). During the re-chase operation, sound output will be muted. If the drift is within 10 frames, the slave will recognize this and continue to travel. Because the master supplies digital signal to slave in this system, re-chase is rarely carried out following chase lock.

- * Should the D-160 fail to correctly chase lock and control, re-check the connection /cables and all settings.

Selecting a recording track

Select the recording tracks for both master and slave.

Execution of recording

A variety of recording work can be carried out with all three D-160's in the chase lock mode.

<One point advice>

1. Setting the "Digital input/output track" parameter in the Setup mode allows you to input and output a digital signal. Note the following when you set this parameter.

- * When you set up a digital input track and "DIGITAL (red)" lights up on the display, the D-160 is ready for syncing with an external word clock via the input digital signal. Use caution not to make a digital signal loop as mentioned previously.
- * When you set up a digital input track, the settings for the external sync signal of the "Slave mode setting" in the Setup mode (that is, Vari, SP DIF, adat, and Free) will be ignored, and the D-160 will sync with the specified digital input signal. Refer to "2-13. Slave Type setting" in Setup mode on page "155" for more information.
- * When you set up a digital input track, the Vari-pitch function is turned off (the LED is also turned off).

2. You can integrate the "MIDI clock sync" operation or "MTC sync/MMC system" operation (as mentioned before) into this multitrack system.

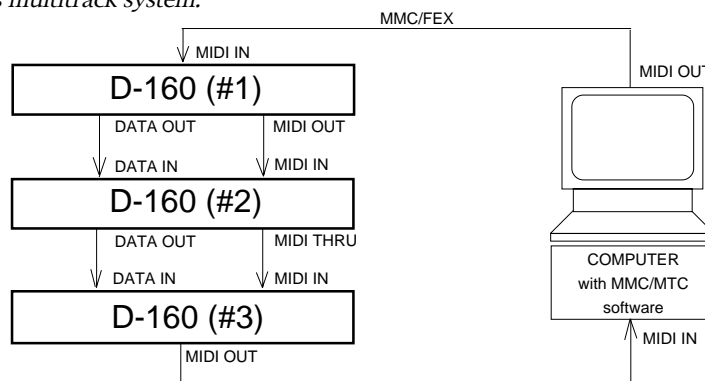

Connection:

MIDI OUT of D-160 (#3) is connected to MIDI IN of the external MIDI equipment.

Setup of the MIDI sync signal:

In D-160 (#3), select either the MIDI clock necessary for synchronizing or MTC.

- * For MIDI clock sync, the external MIDI equipment and D-160 (#3) must be setup by the previously discussed "MIDI clock sync" procedure.
- * For MTC sync, the external MIDI equipment and D-160 (#3) must be setup by the previously discussed "MTC sync/MMC system" procedure.
- * Control of each D-160 becomes possible if the DEVICE ID in the sequence software MMC output (3 channels) is set to comply with the DEVICE ID (00, 01, 02) setup in D-160.
- * When in any mode other than output of MIDI CLOCK from the D-160, MMC from MIDI IN and also FEX are automatically merged and output from MIDI OUT.

In the above schematic, the MMC and the reply message of MMC/FEX which are output from D-160 (master) itself and, MMC and FEX output from the computer, are merged and output from MIDI OUT.

4. External MIDI equipment sync system by the slave mode

Up to this point, synchronization with external MIDI equipment has been explained with the D-160 as the master and MIDI equipment as the slave but depending on the slave mode setting, the MIDI equipment can be set as the master and D-160 as the slave.

<Note>

External MIDI equipment which can be used as the master is limited to those which can output MTC.

- * Initialize D-160.
- * Confirm the program and sampling frequency.
- * In the following, the explanation will be on the assumption that a computer (with sequence software) is used.

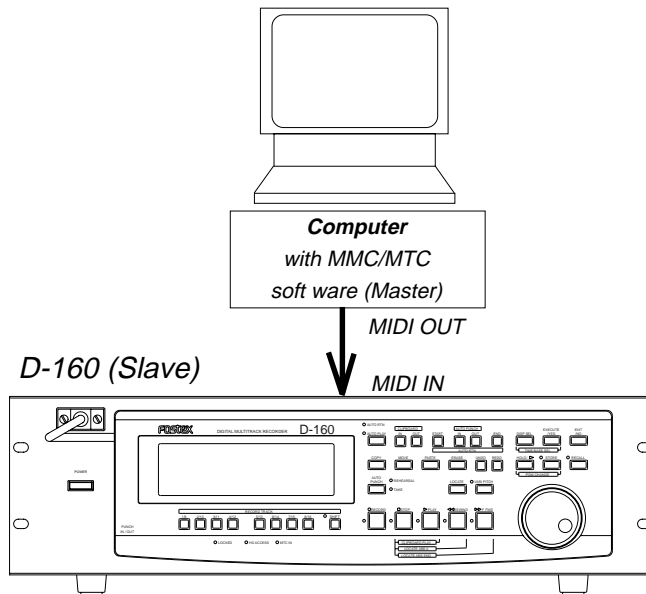

Connection to external equipment

Connect MIDI OUT of the computer (with MIDI interface) with MIDI IN of D-160. The computer sequence software complying to MMC/MTC must be activated.

Setup of external equipment

Sequence software is setup as follows.

- * Set for output of MTC.
- * Set frame rate of the MTC to be output.
- * Confirm start time of the tune.

Refer to Owners Manual of the respective equipment for details.

Setup of D-160

1. Set to same frame rate as the sequence software by the SETUP mode "MTC Frame rate setting."

Refer to page "151", SETUP mode "2-9. MTC Frame rate setting" for operating procedure and details.

2. Set to the desired mode by the SETUP mode "MTC offset mode setting."

Refer to page "153", SETUP mode "2-11. MTC offset mode setting" for operating procedure and details.

3. A random offset time can be set by the SETUP mode "MTC offset time setting."

Refer to page "152", SETUP mode "2-10. MTC offset time setting" for operating procedure and details.

4. **Set slave mode to "On" by the SETUP mode "Slave mode setting," and the slave type to "Vari" by the SETUP mode "Slave mode type setting."**

Refer to page "154", SETUP mode "2-12. Slave mode setting", and page "155", SETUP mode "2-13. Slave mode type setting", for operating procedure and details.

5. **Press the DISP SEL key while pressing on the EXECUTE/YES key to change the time base display to MTC.**

<Precautions at MTC related setups>

The position (ABS 0 or 001BAR/1BEAT/00CLK) when the setup MTC (MTC offset time) should be output was setup by the "MTC offset time setting" and "MTC offset mode setting." In accordance to start time of the tune set by the sequence software, setup as explained below.

Offset mode: For ABS

Set the MTC offset time about three seconds prior to the start time of the tune set by the sequence software. Because the D-160 cannot immediately chase lock after input of MTC, in order to sync the D-160 from head of the tune, set the preroll using the sequence software, and playback from before the actual head of the tune to allow the D-160 to enter into sync by the time it arrives at the head of the tune.

Offset mode: For BAR/BEAT

The MTC offset time can be set to the same time as the start time of the tune set by the sequence software. Because the "ABS 0" position is set at the "0002BAR/1BEAT/00CLK" position in the D-160, as mentioned before, the preceding time required for sync is already set. The preceding time of two bar lengths could change in length depending on the first bar's "signature setting" and "tempo setting" mentioned before. For example, it will be longer if the tempo is slowed down.

Confirming chase lock

1. **When the sequence software is played, MTC IN LED of the D-160 will light, "CHASE" in the display will change from blinking to lit and the chase lock will be completed.**
Check that the MTC output by the sequence software and MTC time displayed in the D-160 are the same.
2. **When the sequence software stops, MTC will be interrupted and the D-160 will also stop.**
"CHASE" in the display will change from lit to blinking.
3. **During FF/REW of the sequence software, D-160 will remain stopped but upon starting to record, the D-160 will immediately chase lock.**

<Note>

Chase lock of the D-160 by MTC only is permissible when speed difference of the MTC from the master is within +/- 5.6%. Against the MTC within this range, variable pitch will be constantly applied internally for chasing. Chase lock, however, will not function against MTC at a speed difference outside this range.

Also, when the master speed difference is large, it is advised to let D-160 learn the master speed by entering PLAY prior to recording. By doing so, it will be lock faster from the second and later sessions.

- * Should it not be possible to chase lock, re-check connections / cables and all settings.

Execution of recording

Carry out various recordings while the D-160 is chase locked to the sequence software.

<One Point Advice>

Sync signal "Free" of the "Slave mode setting" menu:

When the D-160 is made to chase lock by MTC only, variable pitch will be constantly applied by external MTC. If a digital signal is output to an external digital equipment from the D-160, it will not be able to follow the speed difference (MTC speed difference of the master) of the D-160 and the external digital equipment, in some cases, may not be able to input a continuous digital signal.

As a counter measure, the sync signal should be set to "Free" by the "Slave mode setting" menu. Using this setting, the D-160 will enter self operation by the internal clock, after completion of chase lock, and it will be possible to supply a stable digital signal to the external equipment.

Under this setting, when MTC drift between the master unit and slave unit exceeds 10 frames, the D-160 will assume that chase lock has been disengaged and the slave unit will carry out position matching again with the master unit (re-chase operation). During the re-chase operation, sound output will be muted and the digital signal will also be interrupted. If it is within 10 frames, the slave unit will continue to run while admitting this drift.

<Note>

When you select "Vari" for the Slave mode setting, the D-160 will use the Vari-pitch function to lock to the MTC coming from the master device.

However, if you select an S/P DIF digital signal or an adat digital signal for the digital input track in Setup mode, the D-160 will sync with the word clock via the input signal.

Therefore, when you set up a digital input track, the D-160 will not sync with the MTC even if "Vari" has been selected for the Slave mode setting. Once the D-160 locks to the master device, it will sync to the external digital input signal (in the same manner as when SP DIF or adat signals are used).

5. Sync system with "adat" by the slave mode

This section will explain the sync system using "adat" equipment such as the Fostex RD-8.

- * Initialize D-160.
- * Confirm the program.
- * Set RD-8 and D-160 to the same sampling frequency.

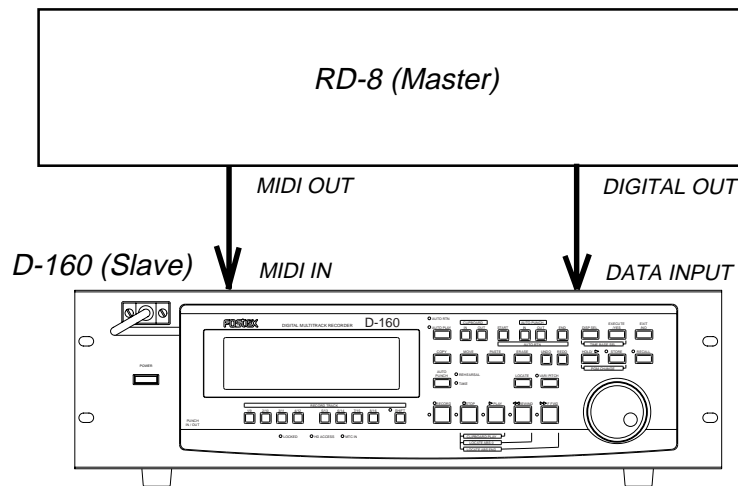

Equipment connections

Make connections, respectively, RD-8 DIGITAL OUT to D-160 DATA IN, and RD-8 MIDI OUT to D-160 MIDI IN.

<Note>

In order to slave operate adat equipment and the D-160, the best setting is to supply "adat" digital signals together with MTC from the master unit.

Setup of RD-8 (master)

1. Setup for output of MTC.
2. Setup the MTC frame rate to be output.
3. Check the MTC time to be output.
4. If necessary, set to allow output of "adat" digital signals.

This is unnecessary for the RD-8.

Refer to the RD-8 Owners Manual for details.

Settings on the D-160

1. Set the same frame rate as the RD-8 for the "MTC Frame rate setting" in the Setup mode.

Refer to "2-9. MTC Frame rate setting" in Setup mode on page "151" for the operation and more information.

2. Select a desired mode for "MTC offset mode setting" in the SETUP mode. (*)

Refer to "2-11. MTC offset mode setting" in Setup mode on page "153" for the operation and more information.

3. "MTC offset time setting" in Setup mode allows you to set the MTC time to start the Chase Lock operation. (*)

Refer to "2-10. MTC offset time setting" in Setup mode on page "152" for the operation and more information.

4. Set Slave mode "On" for "Slave mode setting" in Setup mode, and select "adat" as a slave mode type for "Slave mode type setting" in Setup mode.

Refer to "2-12. Slave mode setting" in Setup mode on page "154", and "2-13. Slave mode type setting" in Setup mode on page "155", for the procedure and information.

5. Press the DISP SEL key while holding down the EXECUTE/YES key to select the MTC indication for the Time Base.

<Notes on setting the MTC offset time>

"MTC offset time setting" and "MTC offset mode setting" determine at which point (ABS 0 or 001BAR/1 ↓ /00CLK) the MTC (MTC offset time) is output. Refer to the following, depending on the song start time set in your sequence software, to set the MTC output from the RD-8.

* Offset mode: ABS

When the master device (RD-8) outputs the specified MTC (MTC offset time), the slave D-160 will start the Chase-Lock operation. Remember that it will take a little time for the D-160 to start chase-lock after the MTC is input. Setting the MTC offset time will allow the Chase-lock operation to start from the specified point of the master device. For example, when the master device (RD-8) outputs MTC as 00h 00m 00s 00sf ~ 00h 40m 00s 00sf, if the D-160 offset (ABS mode) is 00h 20m 00s 00sf, the D-160 ABS time will lock from 23h 40m 00s 00sf, and if the frame rate setting is 30 frame, lock will disengage temporarily at 23h 29m 59s 29f.

Later on, it will lock again at ABS time in the vicinity of 00h 00m 03s.

This is an indication that the ABS time 24h is set as access maximum time in the D-160 and that return to "0" is not continuous.

Should no overshooting of 24h occur in the ABS time, overshooting of 24h with a random MTC OFFSET can be carried out correctly.

* Offset mode: BAR ↓

As described previously, the D-160 uses "-002BAR/1 ↓ /00CLK" as an "ABS 0" point, there is enough time until the Chase Lock starts, and Chase Lock will be complete by the specified MTC offset time. The time length of the two bars before the Chase Lock will vary depending on the settings in the first bar for the "Time signature setting" and the "Tempo setting." Setting the MTC offset time will also allow the Chase Lock operation to start from the specified point of the master device.

<Note>

After this setting, check the following items on the D-160:

* "CHASE" is flashing on the display: When the Chase Lock operation is complete, this indicator will light.

* "DIGITAL" lights up on the display: The unit is syncing to the external digital signal.

<Note>

Do not connect or remove the optical cable from the DATA IN connector while Slave mode is on. Otherwise, the unit may generate noise, affecting the connected external devices.

Checking Chase Lock

- 1. When the master device (RD-8) is played, the MTC IN LED on the slave machine (D-160) will light, then "CHASE" will light in the display, and Chase Lock will be complete.**
Check to make sure the display shows the correct MTC time.
- 2. When you stop the master device, the MTC transmission from the master device will be interrupted and the slave machine will also stop.**
The illuminated "CHASE" will flash.
- 3. While the master device is in fast forward or rewind mode, the slave machine will remain stopped.**
When you start playing the master device, the slave machine will start the Chase Lock operation.

<Note>

The D-160's re-chase window is "10 frames" fixed. That is, when the MTC of the master device and the MTC of the slave machine slip from each other by 10 frames or more, the slave machine will interpret this as being out of sync, and it will try to lock with the master device again (this is called a "re-chase" operation). During the re-chase operation, audio output will be muted. If slippage is within 10 frames, the slave machine will continue running while accepting the slippage. Since the master device supplies a digital signal to the slave machine in this system, the slave machine will not perform the re-chase operation after chase lock is complete.

- * If the Chase Lock operation or control is not correct, check all connections, cables, and settings.

Recording

You may perform recording while the RD-8 and the D-160 are chase-locked.

* Setting the "Digital input track setting" and "Digital output track setting" on the D-160 will allow audio to be transferred between devices in the digital domain. Please note that a track specified for digital input will not accept an analog signal. When this system is to be used with the digital input track set to "adat," because an analog can be input to the adat track not connected, a digital 8 track and analog 8 track can be simultaneously recorded. For example, if DATA INPUT 1-8 are being used and DATA INPUT 9-16 are not connected, analog signals can be input in the analog input 9-16 connectors.

6. Multitrack system using a D-90 / D-80 (Ver. 2) / DMT-8 (Ver.2/VL)

This section explains a multitrack system that uses the D-160 as master and a D-90, D-80, D-80Ver. 2, DMT-8 Ver. 2, or DMT-8VL as slave. Using the D-160 as a master device allows for Chase Lock operation using the Vari-pitch function or the MTC. The example explained here uses Fostex DMT-8 Ver. 2 as a slave machine, but you can use another model with the same settings to configure the multitrack system.

<Note>

A DMT-8, which does not have a Slave Sync function, cannot be used in this system. However, it can be used as a master device. Refer to the "Hint" described later.

<Note>

Note the following when you use the D-160 along with a D-90, D-80, D-80 Ver. 2, DMT-8 Ver. 2, DMT-8VL, or DMT-8.

1. Use only Programs P1 - P5.
2. Select 44.1kHz for the sampling frequency.
3. Select S/P DIF for the digital signal. An adat digital signal can be used only on the D-90.

- * Initialize the D-160 and the DMT-8 Ver. 2.
- * Check the Programs on both machines (P1-P5).
- * Set the sampling frequency on both machines to 44.1kHz.

Connecting the devices

- * Connect DATA OUT of the D-160 to DATA IN of the DMT-8 Ver. 2, and MIDI OUT of the D-160 to MIDI IN of the DMT-8 Ver. 2.

<Note>

The best setup is to supply the MTC and S/P DIF digital signal from the master device so slave operation will be successful.

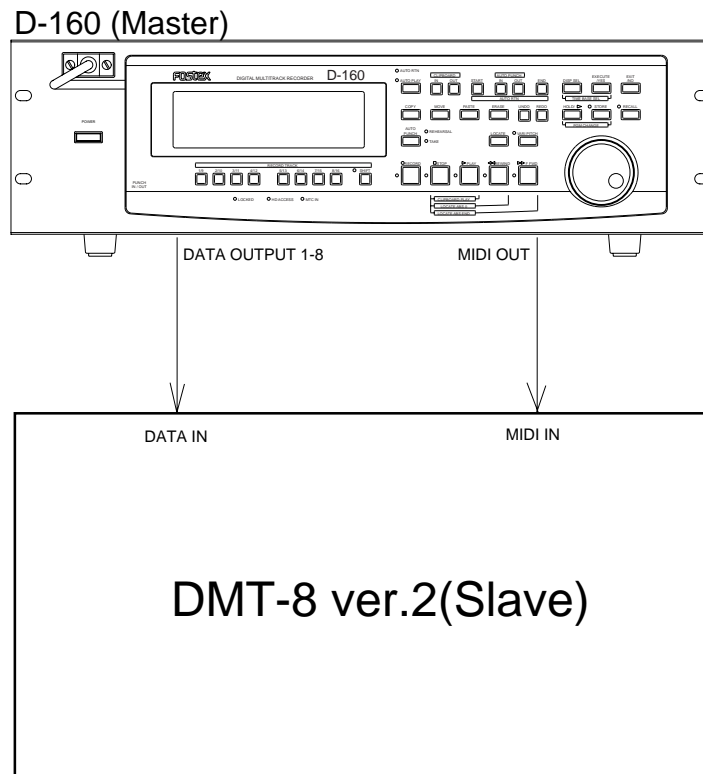

Procedure for the Chase Lock operation

1. **Press a RECORD TRACK select key on both machines to set the tracks in the "READY" mode.**
2. **Press the RECORD and PLAY buttons on the D-160 to start recording.**
The DMT-8 Ver. 2 will also start recording. This is because the master device will send a RECORD command.
This procedure is used to create an area that can be played back on the DMT-8 Ver. 2; you do not need to input audio (silence recording). If you make a silent recording of almost the same length as the song to be recorded, sync operation can be started at any point in the song.
3. **Press the STOP button on both machines.**
* If something has been previously recorded, you do not need to perform this procedure.

<Note>

The D-90, D-80, D-80 Ver. 2, DMT-8 Ver. 2, DMT-8VL, and DMT-8 can play back only the recorded area (ABS 0 through ABS END).
Therefore, if nothing is recorded, they cannot output the MTC or perform the Chase Lock (sync).

At this point the devices are not chase-locked, but recording separately.
Follow the procedure below so that the two units will chase-lock to each other.

Setting the D-160 (Master)

1. **The D-160 will output the MTC for the sync operation.**
Set the "MIDI sync output signal setting" in the Setup mode to "MTC."
Refer to "2-8. MIDI sync output signal setting" in the Setup mode on page "150" for the procedure and additional information.
2. **Set any frame rate for the "MTC Frame rate setting" in the Setup mode.**
Refer to "2-9. MTC Frame rate setting" in the Setup mode on page "151" for the procedure and additional information.
3. **Select "ABS" for the sake of compatibility with the DMT-8 Ver. 2 for "MTC offset mode setting" in the Setup mode.**
Refer to "2-11. MTC offset mode setting" in the Setup mode on page "153" for the procedure and additional information.
4. **Set an offset time for "MTC offset time setting" in the Setup mode.**
Refer to "2-10. MTC offset time setting" in the Setup mode on page "152" for the procedure and additional information.
5. **Set the "MIDI device ID setting" in the Setup mode to "00".**
Refer to "2-18. MIDI device ID setting" in the Setup mode on page "161" for the procedure and additional information.
6. **Select "SP DIF" as the digital output signal for the "Digital output track setting" in the Setup mode.**
* Only an S/P DIF digital signal can be used with the D-80, D-80 Ver. 2, DMT-8 Ver. 2, DMT-8 VL, and DMT-8.
Refer to "2-16. Digital output track setting" in the Setup mode on page "159" for the procedure and additional information.
7. **Press the DISP SEL key while holding down the EXECUTE/YES key to select MTC as the Time Base indication.**

Setting the DMT-8 Ver. 2 (Slave)

Refer to the DMT-8 User's Guide for the procedure and additional information.

1. **Use the same frame rate as the D-160 for the "MTC frame rate setting" in the Setup mode.**
2. **Use the D-160's offset time for the "MTC offset time setting" in the Setup mode.**
There is no "MTC offset mode setting" on the D-80, D-80 Ver. 2, DMT-8 Ver. 2, and DMT-8 VL. When you use the D-160's setting, the MTC offset mode will automatically become "ABS."
3. **Set the "MIDI device ID setting" in Setup mode to "01" on the DMT-8 Ver. 2.**
4. **Set the Slave mode to "On" for the "Slave mode setting" in the Setup mode.**
You can set the Slave mode on the D-80, D-80 Ver. 2, DMT-8 Ver. 2, and DMT-8 VL, but you cannot select a sync signal (SLAVE TYPE). If you use the D-160's setting, "SP DIF" will be automatically selected.
5. **Press the DISP SEL key while holding down the EXECUTE/YES key to select MTC as the Time Base indication.**

<Note>

After this setting, check the following items on the DMT-8 Ver. 2:

- * "LOCKED" LED is flashing: When the Chase Lock operation is complete, this indicator will light.
- * "DIGITAL" lights on the display: The unit is syncing to the external digital signal.

<Note>

Do not connect or remove the optical cable the DATA IN connector while Slave mode is on. This can generate noise, affecting the connected external devices.

Checking Chase Lock

1. **When the master device (D-160) is played, the flashing "PLAY" button lamp will light and Chase Lock will be complete.**
Check to make sure the display shows the correct MTC time.
2. **When you start recording on the master device, the slave device will start recording after the Chase Lock operation is complete.**
3. **When you stop the master device, the MTC transmission from the master device will be interrupted and the slave machine will also stop.**
The illuminated "PLAY" button's lamp will begin to flash.
4. **While the master device is in fast forward or rewind mode, the slave machine will remain stopped.**
When you start playing or recording on the master device, the slave machine will start the Chase Lock operation.

<Note>

The re-chase window of the D-90, D-80, D-80 Ver. 2, DMT-8 Ver. 2, and DMT-8 VL is "10 frames" fixed. This is the same as the D-160. When the MTC of the master device and the MTC of the slave machine slip from each other by 10 frames or more, the slave machine will interpret this as being out of sync, and will try to lock with the master device again (this is called a "re-chase" operation). During the re-chase operation, audio output will be muted. If slippage is within 10 frames, the slave machine will continue running while accepting the slippage. Since the master device supplies a digital signal to the slave machine in this system, the slave machine will not perform the re-chase operation after chase lock is complete.

- * If the Chase Lock operation or control is incorrect, check all connections, cables, and settings.

Selecting a recording track

Select the recording tracks for both master and slave.

Recording

You can record while the D-160 is chase locked.

<One Point Advice>

You can use the D-160 as a slave machine. In this case, set the Slave mode to "On" for the D-160's "Slave mode setting", and set Slave type to "SP DIF" for "Slave mode type setting."

In this system, on the D-160 you can use only those functions available on the D-80, D-80 Ver. 2, DMT-8 Ver. 2, DMT-8 VL, and DMT-8.

Therefore, you cannot use the Vari-pitch function.

SETUP mode

The setup mode allows you to set up parameters for the D-160 according to your requirements.

The contents that you can set up are listed below.

There are two types of setup modes. Some modes are commonly applicable to all programs from 1 to 99 and some others are applicable to each program individually, except for Load, Save & Format.

You can save or load those set up modes, which are applicable program by program as a part of the song data, as we described before in the "SAVING/LOADING SONG DATA" section. But, those which are applicable to all programs are not saved or loaded. Nevertheless, they are memorized even if you turn off the power.

| Mode | Functions | Community | Initial Setting |
|--------------------|--|-----------|-------------------------------|
| "Track Exchange?" | Track Swapping | – | Trk=01 <-> Trk=01 |
| "Signature Set?" | Time Signature Setting (Chosen from 11 setting from 1/4 ~ 8/8) | ○ | 001 bar 04 04 (4/4 beat) |
| "Tempo Map Set?" | Tempo Setting (30~250 bpm) | ○ | 001 bar 1 ♩ ♩=120 (Tempo 120) |
| "Title Edit?" | Program Name Setting (Up to 16 digits) | ○ | #0001 |
| "Delete PGM?" | Program Deleting | – | |
| "Click ♩?" | Metronome ON/OFF Setting | ○ | Off |
| "Preroll Time?" | Preroll Time Setting for LOCATE Function | ○ | 00s (00 second) |
| "Midi Sync Out?" | Midi Sync Out Signal Setting | ○ | CLK (MIDI Clock) |
| "Frame Rate?" | MTC Frame Rate Setting | ○ | 25 Frames |
| "MTC OFFSET" | Offset Time Setting between ABS and MTC | ○ | 0h 59m 57s 00f 00sf |
| "MTC Offset Mode?" | MTC Offset Mode Setting | ○ | ABS |
| "Slave Mode?" | Slave Mode ON/OFF Setting | ○ | Off |
| "Ref. TC?" | Available with Option Model 8345 (Refer to the Model 8345 Owners Manual) | | |
| "Slave Type?" | Slave Mode Type Setting | ○ | Vari |
| "Rec Protect?" | Record Protect ON/OFF Setting | ○ | Off (Record Enable) |
| "Digi. in?" | Digital Input Track Setting | ● | L-, R- (Nothing is assigned) |
| "Digi. out?" | Digital Output Track Setting | ● | Adat |
| "♩ Resolution?" | Bar/Beat Resolution ON/OFF Setting | ● | Off |
| "Device ID?" | MIDI Device ID Setting | ● | 00 (Device No. =00) |
| "Sample Rate?" | Sampling Frequency Setting | ○ | 44.1kHz |
| "8345 Clock?" | Available with Option Model 8345 (Refer to the Model 8345 Owners Manual) | | |
| "Word Out?" | Available with Option Model 8345 (Refer to the Model 8345 Owners Manual) | | |
| "Sync Preset?" | Available with Option Model 8345 (Refer to the Model 8345 Owners Manual) | | |
| "NOs Of Event?" | Event Number Check of a Track | – | |
| "Drive Sel.?" | Current Drive Setting | – | IDE (Internal Hard disk) |
| "Load PGM?" | Loading Song Data from External Device | – | |
| "Save PGM?" | Saving Song Data to External Device | – | |
| "Disk Format?" | Initializing Internal Hard disk/SCSI disk | – | |

○ : Modes applicable program by program. They can be saved/loaded.

● : Modes applicable to all programs. They cannot be saved/loaded.

The "♩" means a quarter note(1/4 note) through out this manual.

1. How to enter the Setup Mode

This is the procedure to arriving at the stage for choosing the other modes you require. The procedure from now on is written assuming the required program has already been selected. So, make sure the program you want to work on is already selected.

1. Press the Display key and choose the flashing **SETUP** mode on the display.



2. Press the EXECUTE/YES key.

The SETUP display stops flashing.

This is the first step in the set up mode.

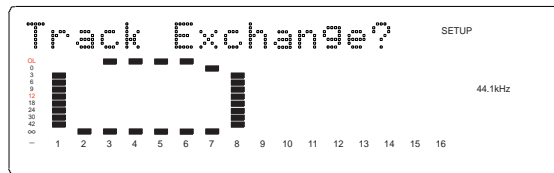

<Note>

The setup menu will show the "Track Exchange?" mode as for the factory default setting or just after you have formatted the internal hard disk drive. However, except for these, the setup menu will show the last mode you chose.

3. Turn the JOG dial and choose the mode you want.

If you rotate the JOG dial either clockwise or counter clockwise, the modes appear one after the other. Some modes also show their current settings.

When you turn the JOG dial, SETUP menus will be displayed in the following order.

As you change the menu, the position indicators in the FL tube display will also start flashing and moving on one after another.

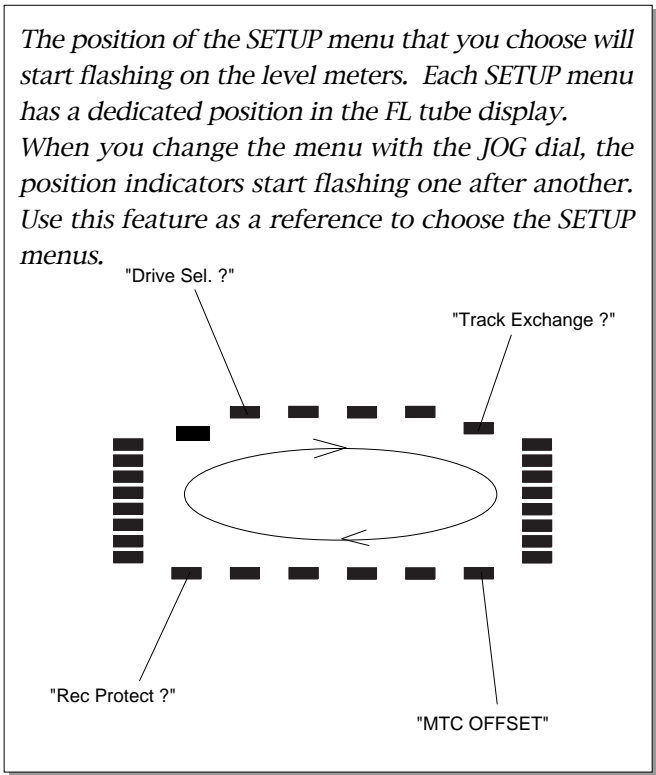
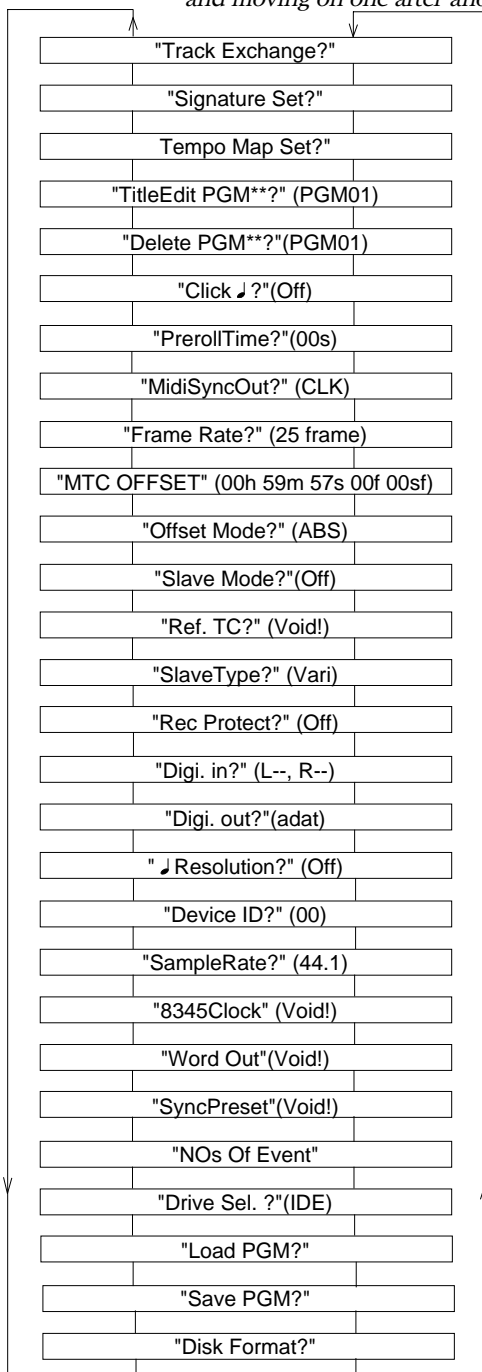

This feature also shows these four menus; "Ref.TC?", "8345 Clock", "Word Out" and "Sync Preset". However, since these menus will only work when the optional accessory Model 8345 is installed, there is no explanation of these functions in manual. Refer to the Model 8345 owners' manual for details.

4. Press the EXECUTE/YES key. The mode you wanted has been chosen.

This is the second step in the SETUP mode.

Refer to the pages below for details of each SETUP mode. For your information, the actual display will appear as follows. (the means flashing display) :

"Track Exchange?" -> Track Swapping

(Initial setting : Trk=01<->Trk=01)

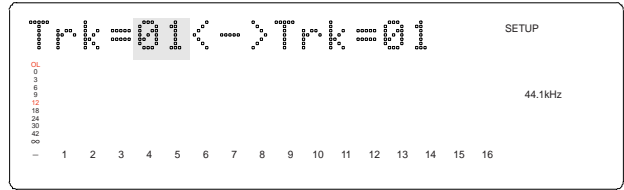

"Signature Set?" -> Time Signature Setting

(Initial Setting : 001 bar 04 04(4/4beat))

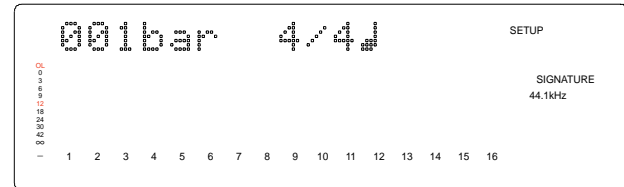

"Tempo Map Set?" -> Tempo Setting

(Initial Setting : 001 bar 1 ♩ ♩=120)

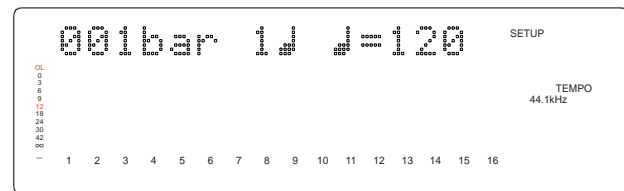

"TitleEdit?" -> Program Name Setting

(Initial Setting : #0001)



"Delete PGM?" -> Program Deleting

(Initial Setting : PGM01)

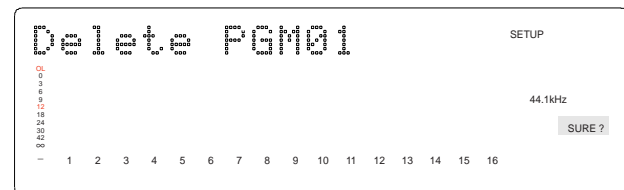

"Click ♩ ?" -> Metronome ON/OFF Setting

(Initial Setting : Off)

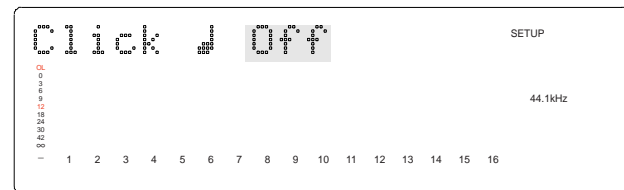

"Preroll Time?" -> Preroll Time Setting for LOCATE function

(Initial Setting : 00s)

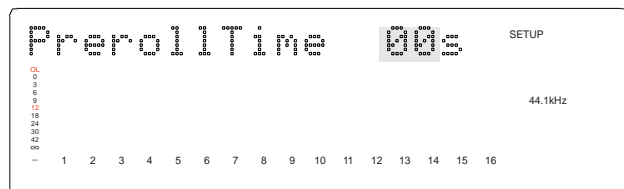

"MidiSyncOut?" -> MIDI Sync Out Signal Setting

(Initial Setting : CLK)

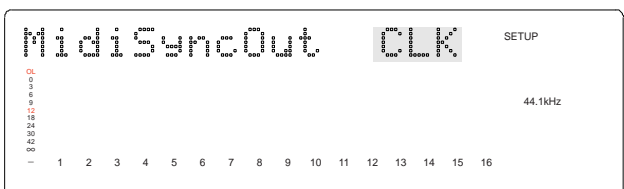

"Frame Rate?" -> MTC Frame Rate Setting

(Initial Setting : 25 frame)

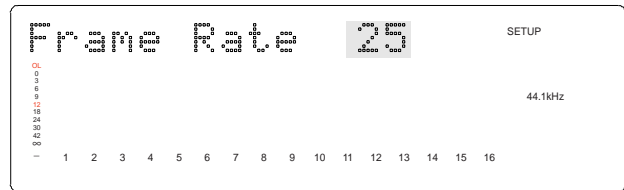

"MTC OFFSET" -> Offset Time Setting between ABS and MTC

(Initial Setting : 00h 59m 57s 00f 00sf)

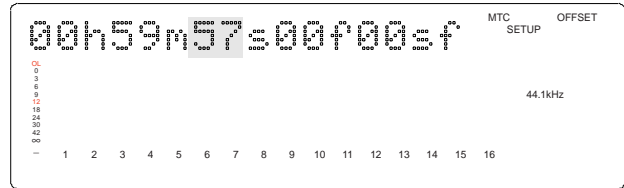

"MTC Offset Mode?" -> MTC Offset Mode Setting

(Initial Setting : ABS)

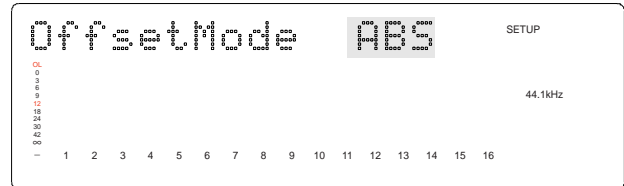

"Slave Mode?" -> Slave Mode ON/OFF Setting

(Initial Setting : Off)



"Slave Type?" -> Slave Mode Type Setting

(Initial Setting : Vari)

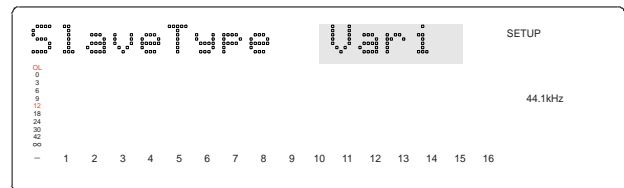

"Rec Protect?" -> Record Protect ON/OFF Setting

(Initial Setting : Off)



"Digi. in?" -> Digital Input Track Setting

(Initial Setting : L-, R-)

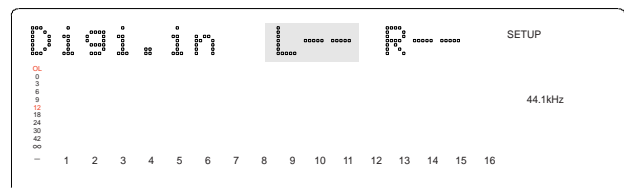

"Digi. out?" -> Digital Output Track Setting

(Initial Setting : adat)

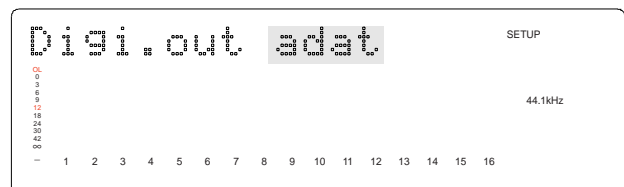

"Resolution?" -> Bar/Beat Resolution ON/OFF Setting

(Initial Setting : Off)

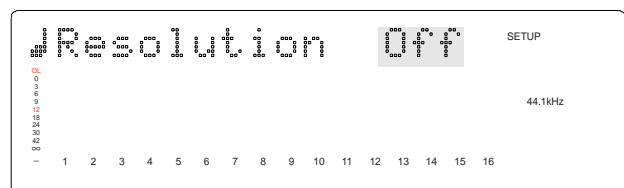

"Device ID?" -> MIDI Device ID Setting

(Initial Setting : 00)

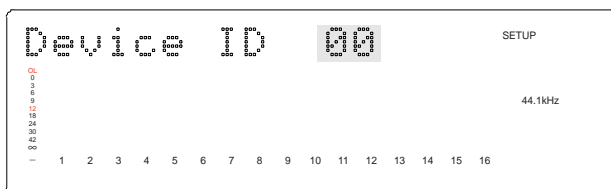

"Sample Rate?" -> Sampling frequency Setting

(Initial Setting : 44.1kHz)

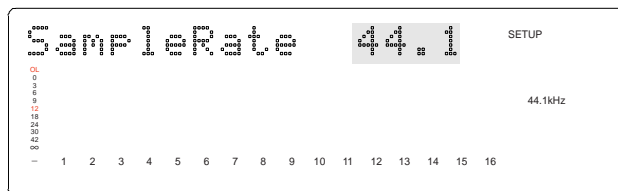

"NOs Of Event?" -> Event Number Check of a Track

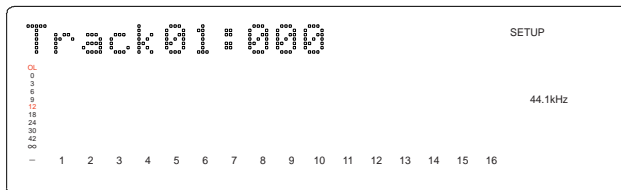

"Drive Sel. ?" -> Current Drive Setting

(Initial Setting : IDE)

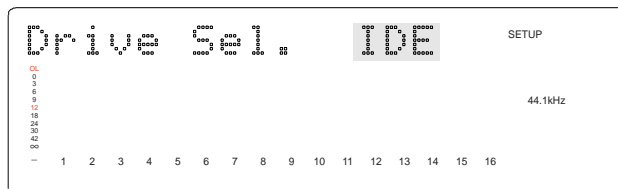

"Load PGM?" -> Loading Song Data from External Device

(Initial Setting : DAT)

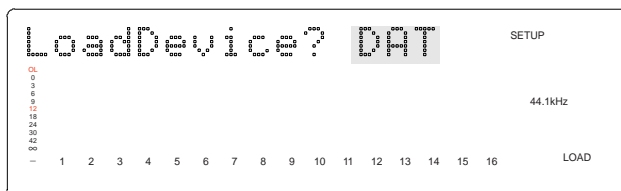

"Save PGM?" -> Saving Song Data to External Device

(Initial Setting : DAT)

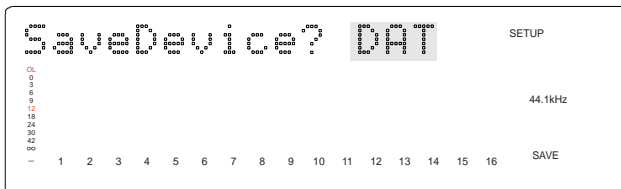

"Disk Format?" -> Initializing Internal Hard disk /SCSI disk

(Initial Setting : IDE)

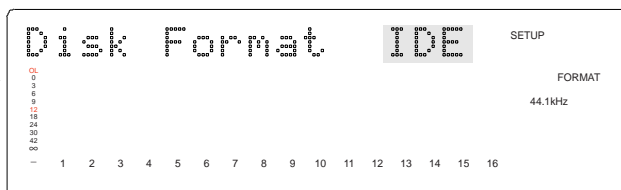

* Press either the STOP button or EXIT/NO key to return from the second step to the first or to quit SETUP mode. The menu will go backwards each time you press either key so that you can correct the setting, choose another SETUP mode or eventually return to the normal time base display.

2. How to set each Mode

2-1. Track Swapping ("Track Exchange?")

This mode allows you to swap a mono track with one of the other recorded tracks, e.g. swapping track 1 with track 16. Mono track swapping can be done on any two tracks from track 1 to track 24 including the additional tracks.

The mode also allows you to swap 8 real tracks with 8 additional tracks at once. In this case, you can either swap tracks 1 ~ 8 with tracks 17 ~ 24 or tracks 9 ~ 16 with tracks 17 ~ 24.

tracks 17



<Note>

You can only swap tracks within a program. It is not possible to swap tracks between different programs.

1. Press the **DISP SEL** key and choose the flashing **SETUP** mode on the display. Then, press the **EXECUTE/YES** key. The **SETUP** display will stop flashing.

2. Choose "Track Exchange?" with the **JOG** dial. The "?" display will start flashing.

3. Press the **EXECUTE/YES** key.

You have arrived at the second step of the "Track Exchange?" menu.

The display will now show "Trk=01 <-> Trk=01" in the current program as in the figure below.

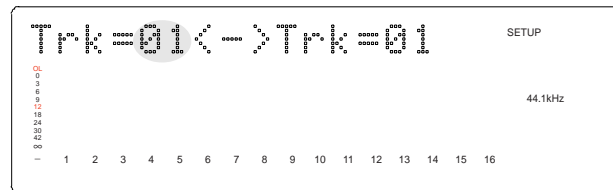

4. Use the **JOG** dial to enter the track you want.

Then, use either the **HOLD/>** key or **SHUTTLE** dial to move the flashing track number so that you can choose another track.

For example, if you choose "02" on the left hand side "Trk=*" and "08" on the right hand side, it means you are swapping Track 2 with Track 8.

Even if you chose the numbers the other way round, i.e. Trk=08<->Trk=02, the result would be the same. In the case you want to swap 8 tracks with the additional tracks, you can choose either Trk=1-8<->Trk=17-24 with the left hand side "Trk=*" flashing on the display or Trk=17-24<->Trk=9-16 with the right hand side "Trk=*" flashing on the display. because these 8 track settings are situated between Track 24 and Track 01, find them by rotating the **JOG** dial.

5. Press the **EXECUTE/YES** key after you have chosen the two tracks you want.

The display will now show "Exchange 02 <-> 08" and be flashing "SURE?".

6. Press the **EXECUTE/YES** key once again to proceed.

After swapping the recorded data on track 2 with one on track 8, the display will show "COMPLETED!". Then go back to the normal time base display as before you entered **SETUP** mode.

2-2. Time Signature Setting ("Signature Set?")

This mode sets up the time signature of a song.

The way it sets this up is, for example, to start a song with a 4/4 beat from the first bar, then to change it to a 2/4 beat at bar number 17. The time signature and next section tempo setting make up a tempo map. After the tempo map is figured out by completing the time signature and tempo setting, the D-160 will be able to handle "BAR /BEAT/ CLOCK" and the metronome function. You need to set up the time signature and tempo to generate the MIDI Clock & Song Position Pointer.

* Refer to page "117" for details of "MIDI Clock Synchronization".



<Note>

The D-160 will still run the time counter in PLAY mode even after the ABS END. Thus, it will continue generating the MIDI Clock & Song Position Pointer even if you have not recorded anything, provided a tempo map has been set up.

* Initial Setting: 001Bar 4/4 Beat

* Available bars: 001 ~ 999

* Available time signature: 1/4, 2/4, 3/4, 4/4, 5/4, 1/8, 3/8, 5/8, 6/8, 7/8, 8/8, -/- (Delete)

* Maximum setting points : 64

* The setting is applicable song by song.

* The setting can be saved or loaded as a part of the song data

* The setting is memorized even when the power is off.

* Make sure you choose the right program before setting this mode.

1. Press the DISP SEL key and choose the flashing SETUP mode on the display. Then, press the EXECUTE/YES key.

The SETUP display stops flashing.

2. Choose "Signature Set?" with the JOG dial. The "?" display will start flashing.
3. Press the EXECUTE/YES key.

The D-160 will display "SIGNATURE" and the last recalled bar number with the time signature that has been registered. In the case of the initial setting, as only the first bar is registered with a 4/4 beat, it will show "001 bar • 4/4 beat".

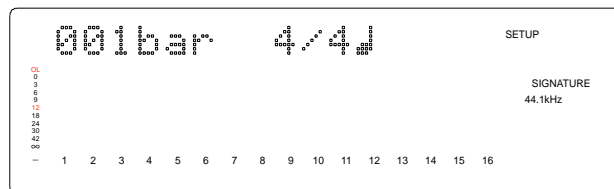

Time Signature Setting Check

4. Turn the JOG dial when the D-160 displays "SIGNATURE".

If there are some setting changes registered in a song, you can see the next set up point by rotating the JOG dial clockwise. ("*** bar */* ♪")

If you turn the JOG dial fully clockwise, "-- BAR -/- ♪" will be displayed.

This means there are no more time signature changing points registered.



<Note>

The D-160 counts a beat with the last registered time signature, i.e. one bar before the "-- bar -/- ♪". In the case of the initial setting, because only the first bar is registered with a 4/4 beat, the beat counts with a 4/4 beat until the end unless you register a different time signature after the second bar.

Time Signature Register

5. Press the EXECUTE/YES key when the D-160 displays "SIGNATURE".

The display will show "*** bar" flashing to allow you to enter a new time signature changing point.

- 6. Use either the HOLD/> key or SHUTTLE dial to choose "bar" or "↓ beat". Then, use the JOG dial to enter the bar number or time signature you want.**

The bar numbers you can enter are from 001 to 999. And the time signatures you can enter are "1/4, 2/4, 3/4, 4/4, 5/4, 1/8, 3/8, 5/8, 6/8, 7/8, 8/8". For your information, the "-/-/" means "No Signature registered" and can be used to delete a signature change point. When you turn the JOG dial while the display shows "*** bar" flashing, it will either show the time signature as "*/*" on the already registered bars or as "-/-/" if a bar has no time signature registered.

- 7. Press the EXECUTE/YES key after you have entered a required bar number and time signature.**
The setting will now be registered. Then, the display will go back to Item 5 and show "*** bar" flashing, allowing you to enter a new time signature setting.
- 8. Repeat the procedures described in items 5 ~ 7 to register further time signatures.**

* Press either the STOP button or EXIT/NO key to return from the second step to the first or to quit SETUP mode. The menu will go backwards each time you press either key so that you can correct the setting, choose some other SETUP mode or eventually return to the normal time base display.



<Note>

You can register the setting up to 64 points. If you try to register over 64 points, the 65th point onwards will be ignored.

Time Signature Edit & Delete

Follow the procedures described as in Items 1 ~ 5.

- 6. When the display shows flashing "*** bar", choose the bar that carries the signature you want to edit with the JOG dial.**
- 7. Press the HOLD/> key or turn the shuttle dial to choose the "*/* ".**
The flashing display will move to the "*/*" and allows you to change the time signature setting.
- 8. With the JOG dial, choose a required time signature.**
If you choose "-/-/", the time signature on the bar will be deleted.
- 9. Press the EXECUTE/YES key after you have changed or deleted the time signature on the bar number you wanted.**

The setting will now be registered. Then, the display will return to Item 5 and show "*** bar" flashing, which allows you to enter a new time signature setting.

* Press either the STOP button or EXIT/NO key to return from the second step to the first or to quit SETUP mode. The menu will go backwards each time you press either key so that you can correct the setting, choose some other SETUP mode or eventually return to the normal time base display.



<Notes>

* You cannot register the "-/-/" setting on the 001bar.

* If the registered tempo changing point becomes unavailable, after you alter the time signature, the particular beat which used to carry some tempo changing will automatically disappear. For example, the registered tempo at 010 bar 4 ↓ will disappear if you edit the time signature at the 010 bar to 3/4 beat.

Delete all Time Signature Setting at once

Follow the procedures described as in items 1 ~ 5.

- 6. While the display shows "*** bar" flashing, turn the JOG dial fully counter clockwise.**

The display will now show "All Clear?" and flashing "SURE?".

- 7. Press the EXECUTE/YES key to proceed.**

All the registered time signature settings will be erased and go back to the initial setting. Then, the display will go back to item 5 and show "*** bar" flashing.

<Note>

Be careful because this procedure wipes out the tempo setting as well as time signature setting.

* Press either the STOP button or EXIT/NO key to return from the second step to the first or to quit SETUP mode. The menu will go backwards each time you press either key so that you can correct the setting, choose some other SETUP mode or eventually return to the normal time base display.

2-3. Tempo Setting ("Tempo Map Set?")

This mode sets up the tempo on a song. The way it sets this up is, for example, for the tempo to become 150 bpm at the 3rd beat in the 12th bar.

The tempo setting and time signature in the previous section make up a tempo map. After the tempo map has been calculated by completing the tempo and time signature setting, the D-160 will be able to handle "BAR /BEAT/CLOCK" and the metronome function. You need to set up the tempo and time signature to generate the MIDI Clock & Song Position Pointer.

* Refer to page "117" for details of "MIDI Clock Synchronization".



<Note>

The D-160 will still run the time counter in PLAY mode even after the ABS END. Thus, it will continue generating the MIDI Clock & Song Position Pointer even if you have not recorded anything, provided a tempo map has been set up.

- * Initial Setting: 001Bar 1st Beat 120 bpm
 - * Bar to register: Follows to the time signature setting
 - * Beat to register : Follows to the time signature setting
 - * Available tempo : 30 ~ 250, -- (Delete)
 - * Maximum setting points : 64
 - * The setting is applicable song by song.
 - * The setting can be saved or loaded as a part of the song data
 - * The setting is memorized even when the power is off.
- ★ Make sure you choose the right program before setting this mode.

1. Press the DISP SEL key and choose the flashing SETUP mode on the display. Then, press the EXECUTE/YES key. The SETUP display will stop flashing.
2. Choose "Tempo Map Set?" with the JOG dial. The "?" display will start flashing.
3. Press the EXECUTE/YES key.

The D-160 will display "TEMPO" and last recalled bar number with its tempo setting which is already registered. In the case of the initial setting, because only the first bar, first beat is registered with a 120 bpm, it will show "001 bar, 1 ♩ • ♩ = 120".

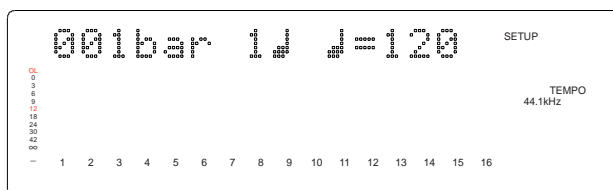

Tempo Setting Check

4. Turn the JOG dial when the D-160 displays "TEMPO".

If there are some setting changes registered in a song, you can see the next set up point by rotating the JOG dial clockwise. ("*** bar * ♩ , ♩ = ***")

If you turn the JOG dial fully clockwise, "-- BAR -- ♩ , ♩ = --" will be displayed.

This means there is no more tempo changing points registered.



<Note>

The D-160 counts a beat with the last registered tempo, i.e. one bar before the "-- bar -- ♩ , ♩ = --". In the case of the initial setting, because only the first beat of first bar is registered with a 120bpm, the beat counts with a 120bpm until the end unless you register a different tempo after the second beat of first bar.

Tempo Register

5. Press the EXECUTE/YES key when the D-160 displays "TEMPO".

The display will show flashing "*** bar" so that it allows you to enter a new tempo changing point.

6. Use either the HOLD/> key or SHUTTLE dial to choose "bar", "♪ beat" or "TEMPO".

Then, use the JOG dial to enter a required bar/beat and tempo that you want to register.

The bar numbers and beat you can enter follows the time signature setting described in the previous section, and the tempo settings you can enter are 30 ~ 250 bpm. For your information, the "- -" means "No tempo setting registered" and can be used to delete a tempo change point. When you turn the JOG dial while the display shows "*** bar" or "♪" flashing, it will either show the tempo as "***" on the already registered bar/beat or as "- -" if a bar/beat has no tempo setting registered.

7. Press the EXECUTE/YES key after you have entered a required bar/beat and tempo.

The setting will now be registered. Then, the display will go back to Item 5 and show "*** bar" flashing so which you to enter a new tempo setting.

8. Repeat the procedures described in items 5 ~ 7 to register further tempo settings.

* Press either the STOP button or EXIT/NO key to return from the second step to the first or to quit SETUP mode. The menu will go backwards each time you press either key so that you can correct the setting, choose some other SETUP mode or eventually return to the normal time base display.



<Note>

You can register the setting up to 64 points. If you try to register over 64 points, the 65th point onwards will be ignored.

Example : A tempo map can be setup as in the following example, i.e. set the required tempo after having set time signature.

| Tempo Map | |
|------------------------|---|
| Time Signature Setting | Tempo Setting |
| 001 bar 4/4 ♪ | 001 bar 1 ♪, ♪=120 003 bar 1 ♪, ♪=90 |
| 005 bar 3/4 ♪ | 005 bar 3 ♪, ♪=60 007 bar 2 ♪, ♪=120 |

Tempo Setting Edit or Delete

Follow the procedures described as in Items 1 ~ 5.

6. Use either the HOLD/> key or SHUTTLE dial to choose "bar", "♪ beat" or "TEMPO".

Then, use the JOG dial to enter a required bar/beat and tempo that you want to edit.

The display will show tempo as "***" on the already registered bar/beat.

7. Press the HOLD/> key or turn the shuttle dial to choose the "♪=*".**

The flashing display will move to "♪=***" so that it allows you to change the tempo setting.

8. With the JOG dial, choose a required tempo.

If you choose "- -", the tempo setting on the bar/beat will be deleted.

9. Press the EXECUTE/YES key after you have changed or deleted the tempo setting on the bar/beat you wanted.

The setting will now be registered. Then, the display will go back to Item 5 and show "*** bar" flashing, which allows you to enter a new tempo setting.

* Press either the STOP button or EXIT/NO key to return from the second step menu to the first or to quit SETUP mode. The menu will go backwards each time you press either key so that you can correct the setting, choose some other setup mode, or eventually return to the normal time base display.



<Note>

You cannot register the "- -" at the 001 bar 1 ♪.

Delete all Tempo Setting at once

If you proceed with "Delete all Time Signature Setting at once" as described in the previous section, the D-160 will erase all the tempo settings as well as the time signature settings.

* Refer to the "Delete all Time Signature Setting at once" section for details.

2-4. Program Title Setting ("Title Edit PGM?")

This mode gives a name to the individual program (maximum of 99 programs). Also, the registered name can be edited.

Choose a required program before you enter to the SETUP mode if you are newly giving a title or editing a title.

1. Press the **DISP SEL** key and choose the flashing **SETUP** mode on the display. Then, press the **EXECUTE/YES** key.

The SETUP display stops flashing.

2. With the **JOG dial**, choose "TitleEdit PGM?".

The "?" display will start flashing.

3. Press the **EXECUTE/YES** key.

The D-160 will enter the second step menu of "TitleEdit PGM?" and show the current program title. In the case of the initial setting, the display will show "#0001" with "#" flashing.

The flashing digit allows you to enter a letter. The available letters are a maximum of 16 digits of alphabet or numbers. The D-160 handles ASCII code.

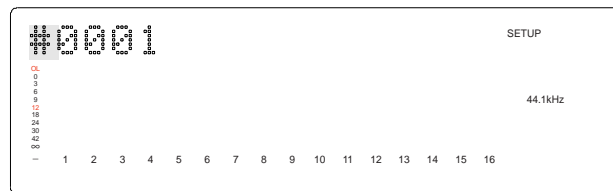

4. Use the **JOG dial** to enter a required letter. Then, use either the **HOLD/>** key or **SHUTTLE dial** to move the flashing digit.

5. Press the **EXECUTE/YES** key after you have entered the required title.

The title will now be registered and the display will then go back to the normal time base display as before you entered SETUP mode.

2-5. Program Delete ("Delete PGM?")

This mode allows you to delete program data which you no longer need.

You can delete the currently chosen program to obtain more recording space.

**<Notes>**

- * The D-160 automatically renumbers the remained programs after deleting a program between the other two programs. For example, if you delete program number 2 of program numbers 1,2,3 and 4, number 3 will automatically become the new program number 2 and number 4 will become the new program number 3. Then, the D-160 will end up having three programs rather than four.
- * If you try to delete program number 1 when there is only one program available, the D-160 will set up a new blank program 1 after erasing the current program 1 data.
- * This program delete mode does not have an "UNDO" function.
- * The Program delete mode will not work if the "Rec Protect ?" mode is set to On. The D-160 will display "Disable REC!" as a warning message and go back to the normal time base display the same as before you entered SETUP mode.

1. Press the DISP SEL key and choose the flashing SETUP mode on the display. Then, press the EXECUTE/YES key.

The SETUP display will stop flashing.

2. With the JOG dial, choose "Delete PGM?". The "?" display will start flashing.

3. Press the EXECUTE/YES key.

The display will start flashing "SURE?" which indicates it is ready to delete.

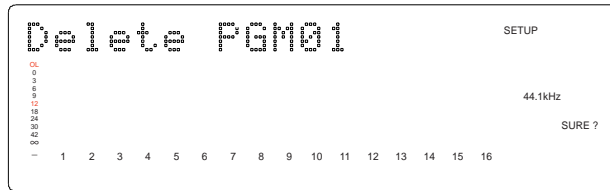

4. Press the EXECUTE/YES key once again to proceed.

The D-160 will show "Deleting!" while proceeding and "COMPLETED!" after deleting the currently displayed program. The display will then go back to the normal time base display on the program before the one you deleted.

2-6. Metronome Setting ("Click ♪ ? ")

The D-160 is able to generate the metronome click tone according to the tempo map figured out by the time signature and tempo setting.

You can record a track at the same time as listening to the metronome click tone.

If you set this mode to ON, track 16 will generate the metronome click tone in either play or record mode.



<Notes>

*If you set this mode to ON, the D-160 cannot playback the recorded sound from track 16, as track 16 will be the click track exclusively. In conjunction with this, do not record track 16 with this mode on. If track 16 is in record mode, the click will not be generated.

*The D-160 will still run the time counter in PLAY mode even after the ABS END. Thus, it will continue generating the metronome click tone even if you have not recorded anything, provided a tempo map has been set up.

* Initial setting : Off

* Available setting : Off, On

* The setting is applicable song by song.

* The setting can be saved or loaded as a part of song data

* The setting is memorized even when the power is off.

* Make sure to choose the right program before setting up this mode.

1. Press the DISP SEL key and choose the flashing SETUP mode on the display.

Then, press the EXECUTE/YES key. The SETUP display stops flashing.

2. With the JOG dial, choose "Click ♪ ?". The "?" display will start flashing.

3. Press the EXECUTE/YES key.

The display will start flashing either "Off" or "On" of current setting.

In the case of initial setting it will show "Off".

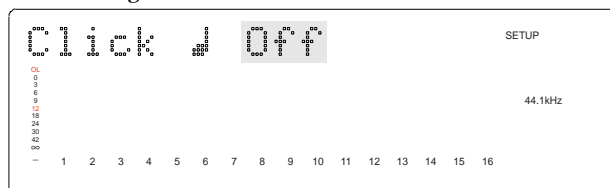

4. Choose either ON or OFF with the JOG dial.

On : Click tone will be generated.

Off : Click tone will not be generated.

5. Press EXECUTE/YES key after choosing the setting you want.

* Press either the "STOP" button or EXIT/NO key to return from the second step menu to the first or to quit SETUP mode. The menu will go backwards each time you press either key so that you can correct the setting, choose some other SETUP mode or eventually return to the normal time base display.

2-7. Preroll Time Setting ("Preroll Time ? ")

The D-160 has a preroll function, which stops at the backwards specified time location. This function is useful when you want to start monitoring the recorded audio from just before a locate point.

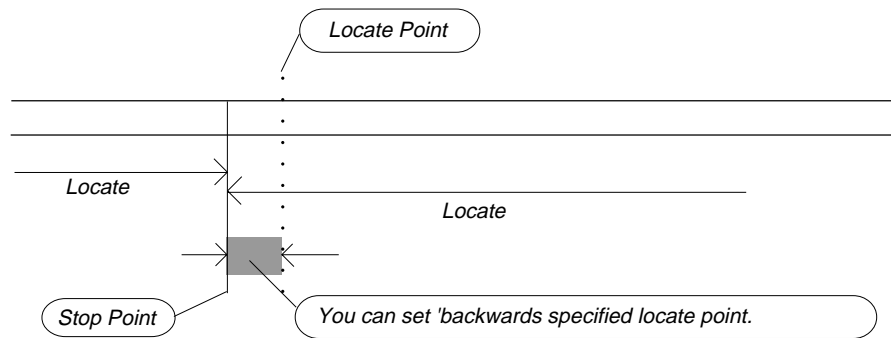

- * Initial setting : 00sec
- * Available setting : 00 ~ 10sec in 1sec step
- * The setting is applicable song by song.
- * The setting can be saved or loaded as a part of the song data.
- * The setting is memorized even when the powering off.
- * Make sure to choose the right program before setting up this mode.

1. Press the DISP SEL key and choose the flashing SETUP mode on the display. Then, press the EXECUTE/YES key.

The SETUP display will stop flashing.

2. With the JOG dial, choose "Preroll Time?".

The "?" display will start flashing. The display will also show the current setting. In the case of initial setting, it will show 00 second.

3. Press the EXECUTE/YES key.

The current setting will start flashing "*" which indicates it is ready to change setting.

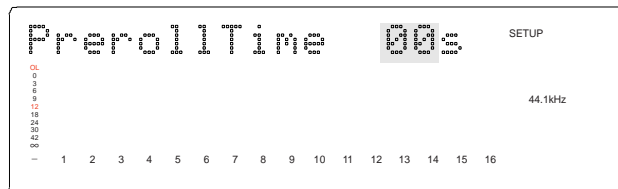

4. With the JOG dial, enter the required preroll time.

You can set the preroll time between 0 and 10 sec in 1 second steps.

If you turn the JOG dial clockwise, the time value will increase. And if you turn the JOG dial counter clockwise, the time value will decrease vice versa.

5. Press the EXECUTE/YES key after you have entered the preroll time you want.

The setting will be registered and the display will go back to the Item 2 above.

* Press either the "STOP" button or EXIT/NO key to return from the second step menu to the first or to quit the SETUP mode. The menu will go backwards each time you press either key so that you can correct the setting, choose some other SETUP mode or eventually return to the normal time base display.

2-8. MIDI Sync Signal Output Setting (“Midi Sync Out ?”)

This mode sets up the type of MIDI sync signal for external MIDI equipment.

The type of signal the D-160 outputs is either MIDI Clock & Song Position Pointer or MTC (MIDI Time Code). Choose one so that the external MIDI equipment can recognize it when synchronizing to the D-160.

In case of the MIDI Clock & Song Position Pointer, you need to set the section "2-2. Time Signature" and section "2-3. Tempo as previously mentioned."

In case of the MTC (MIDI Time Code), you need to set the section "2-9. MTC Frame Rate", "2-10. MTC Offset Time" and "2-11. MTC Offset Mode" described below.

* See page "117" "MIDI Synchronization Function" for details of the MIDI sync.



<Note>

The D-160 will still run the time counter in PLAY mode even after the ABS END. Thus, it will continue generating the MIDI Clock & Song Position Pointer and MTC even if you have not recorded anything, provided a tempo map has been set up.

* Initial setting : CLK

* Available setting : CLK, MTC, Off

Clock : MIDI Clock & Song Position Pointer, MTC : MIDI Time Code

* This setting is applicable song by song.

* This setting can be saved or loaded as a part of the song data.

* The setting is memorized even when the power is off.

* Make sure to choose the right program before setting up this mode.

1. Press the DISP SEL key and choose the flashing SETUP mode on the display. Then, press the EXECUTE/YES key.

The SETUP display will stop flashing.

2. With the JOG dial, choose “MidiSyncOut?”.

The “?” display will start flashing. The display will also show the current setting.

In the case of initial setting, it will show CLK.

3. Press the EXECUTE/YES key.

The current setting will start flashing “**” which indicates it is ready to change setting.

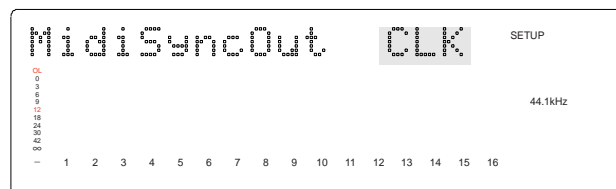

4. With the JOG dial, enter a required Midi Sync Signal.

Choose the type of MIDI signal you want.

If you choose “CLK”, the D-160 generates the MIDI Clock & Song Position Pointer.

If you choose “MTC”, the D-160 generates the MIDI Time Code.

If you choose “Off”, the D-160 generates no MIDI Sync signal.

5. Press the EXECUTE/YES key after you have entered the Midi Sync Signal you wanted.

The setting will be registered and the display will go back to step 2 above.

* Press either the “STOP” button or EXIT/NO key to return from the second step menu to the first or to quit SETUP mode. The menu will go backwards each time you press either key so that you can correct the setting, choose some other SETUP mode or eventually return to the normal time base display.

2-9. MTC Frame Rate Setting (“Frame Rate?”)

If you choose MTC as the MIDI sync signal in the previous section “2-8. MIDI Sync Signal Output Setting”, you need to set up this mode.

You can set up the frame rate of the MTC generated for external MIDI equipment such as computer based sequencer software. Choose the frame rate so that the external MIDI device can receive it.

* See page "120" “MIDI Synchronization Function” for details of the MTC sync.



<Note>

The D-160 will still run the time counter in PLAY mode even after the ABS END. Thus, it will continue generating the MTC even if you have not recorded anything.

* Initial setting : 25 Frames

* Available setting : 24, 25, 30df, 30nd, 29df, 29nd

* This setting is applicable song by song.

* This setting can be saved or loaded as a part of the song data.

* The setting is memorized even when the power is off.

* Make sure to choose the right program before setting up this mode.

1. Press the DISP SEL key and choose the flashing SETUP mode on the display. Then, press the EXECUTE/YES key.

The SETUP display will stop flashing.

2. With the JOG dial, choose “Frame Rate?”.

The “?” display will start flashing. The display will also show the current setting.

In the case of initial setting, it will show 25 frames.

3. Press the EXECUTE/YES key.

The current setting will start flashing “**” which indicates it is ready to change the setting.

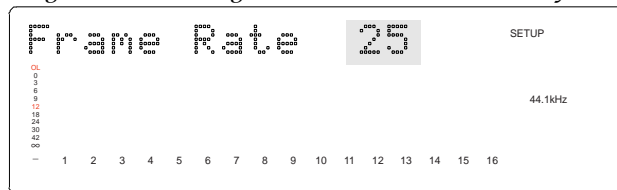

4. With the JOG dial, enter the frame rate you want.

Choose the frame rate you want from;

24, 25, 30 non drop frame, 30 drop frame, 29nd (29.97 non drop frame) and 29df (29.97 drop frame).

5. Press the EXECUTE/YES key once again.

The setting will be registered and the display will go back to the Item 2 above.

* Press either the “STOP” button or EXIT/NO key to return from the second step menu to the first or to quit the SETUP mode. The menu will go backwards each time you press either key so that you can correct the setting, choose some other SETUP mode or eventually return to the normal time base display.



<Note>

There are no 29.97nd or 29.97df in the MTC standard. Use either 30nd or 30df unless you definitely need to synchronize the D-160 with NTSC video.

2-10. MTC Offset Time Setting (“MTC Offset”)

If you choose the MTC as the MIDI sync signal in the previous section “2-8. MIDI Sync Signal Output Setting”, you need to set up this mode.

You can set up the offset time between the MTC output and internal ABS time.

In the case of the initial setting, MTC will output 00h 59m 57s 00f 00sf at the ABS 00h 00m 00s 00f 00sf point which is ABS 0. You can also set the MTC offset based on the 001BAR 1BEAT 00CLK position rather than ABS 0.

Refer to the next section “2-11. MTC Offset Mode Setting” for details.

* See “Before Operation” section “3. Time base” for the time relation between MTC and ABS or BAR/BEAT/CLK.

* See page "120" MIDI synchronization function for details of the MTC sync.



<Note>

The D-160 will still run the time counter in PLAY mode even after the ABS END. Thus, it will continue generating the MTC even if you have not recorded anything.

* Initial setting : 00h 59m 57s 00f 00sf

* Available setting : 00h 00m 00s 00f 00sf ~ 23h 59m 59s 29f 99sf

* This setting is applicable song by song.

* This setting can be saved or loaded as a part of the song data.

* The setting is memorized even when the power is off.

* Make sure to choose the right program before setting up this mode.

1. Press the DISP SEL key and choose the flashing SETUP mode on the display. Then, press the EXECUTE/YES key.

The SETUP display will stop flashing.

2. With the JOG dial, choose “OFFSET”.

The display will show the current setting. In the case of initial setting, it will show 00h 59m 57s 00f 00sf.

3. Press the EXECUTE/YES key.

The “s”, second digits, display will start flashing which is asking you to specify the second digit of the offset time you want.



4. Use either the HOLD/> key or SHUTTLE dial to choose time digits, i.e. “h”, “m”, “s”, “f”, “sf”. Then, use the JOG dial to enter the required time value that you want to register.

The available setting is from 00h 00m 00s 00f 00sf to 23h 59m 59s 29f 99sf.

5. Press the EXECUTE/YES key after you have entered the required Offset.

The MTC Offset will now be registered and the display will then go back to Item 2 above.

* Press either the “STOP” button or EXIT/NO key to return from the second step menu to the first or to quit SETUP mode. The menu will go backwards each time you press either key.



<Note>

We recommend you set about three seconds of preroll time because in the MTC OFFSET of 00h 59m 57s rather than 01h 00m 00s, considering the preparation time to start the external sequencer in the event that you have chosen “ABS” in the MTC OFFSET mode.

2-11. MTC Offset Mode Setting (“MTC Offset?”)

If you choose the MTC as the MIDI sync signal in the previous section “2-8. MIDI Sync Signal Output Setting”, you need to set up this mode. This mode chooses the MTC time with offset, which you have already set in the previous section, to start either from the ABS 0 position or from the 001 BAR 1 BEAT 00 CLK on the tempo map.

* See “Before Operation” section “3. Time base” for the time relation between MTC and ABS or BAR/BEAT/CLK.

* See page “120” MIDI synchronization function for details of the MTC sync.



<Note>

The D-160 will still run the time counter in PLAY mode even after the ABS END. Thus, it will continue generating the MTC even if you have not recorded anything.

* Initial setting : ABS

* Available setting : ABS, BAR ↓

* This setting is applicable song by song.

* This setting can be saved or loaded as a part of the song data.

* The setting is memorized even when the powering is off.

1. Press the DISP SEL key and choose the flashing SETUP mode on the display. Then, press the EXECUTE/YES key.

The SETUP display will stop flashing.

2. With the JOG dial, choose “Offset Mode?”.

The “?” display will start flashing. The display will also show the current setting.

In the case of the initial setting, it will show ABS.

3. Press the EXECUTE/YES key.

The current setting will start flashing which indicates it is ready to change setting.



4. With the JOG dial, enter a required setting either ABS or Bar ↓.

If you choose the “ABS”, the MTC time with offset will output at the ABS 0 position.

If you choose the “Bar ↓”, the MTC time with offset will output at the 001 BAR 1 BEAT 00 CLK position which according to the tempo map.

5. Press the EXECUTE/YES key once again.

The setting will be registered and the display will go back to step 2 above.

* Press either the “STOP” button or EXIT/NO key to return from the second step menu to the first or to quit SETUP mode. The menu will go backwards each time you press either key so that you can correct the setting, choose some other SETUP mode or eventually return to the normal time base display.



<Note>

We recommend that you set about three seconds of preroll time as in the MTC OFFSET of 00h 59m 57s rather than 01h 00m 00s, considering the preparation time to start the external sequencer in the event that you have chosen “ABS” in the MTC OFFSET mode. If you have chosen “Bar ↓”, the D-160 automatically sets two bars worth of preroll time. You can leave the MTC OFFSET as 01h 00m 00s.

2-12. Slave Mode Setting (“Slave Mode”)

This mode allows you to choose the D-160 slave mode setting either ON or OFF. If you set the mode to ON, the D-160 will synchronize to the incoming MTC(MIDI time code)from master unit. It will also synchronize to a type of external sync signal which you have chosen with the section “2-14. Sync Signal Setting”.

You can make up a multi track recording system using Fostex D-90, D-80 (Ver 2), DMT-8 (Ver 2) or DMT-8VL, and also with some sequencer software.

* See Page "117" for MIDI synchronization for more details.

* Initial setting : Off

* Available setting : On, Off

* This setting is applicable song by song.

* This setting can be saved or loaded as a part of the song data.

* The setting is memorized even when the power is off.

* Make sure to choose the right program before setting up this mode.

* Make sure you choose the right sampling frequency before setting up this mode.

1. Press the DISP SEL key and choose the flashing SETUP mode on the display. Then, press the EXECUTE/YES key.

The SETUP display will stop flashing.

2. With the JOG dial, choose “Slave Mode?”.

The “?” display will start flashing. The display will also show the current setting.

In the case of the initial setting, it will display Off.

3. Press the EXECUTE/YES key.

The current setting will start flashing which indicates it is ready to change setting.

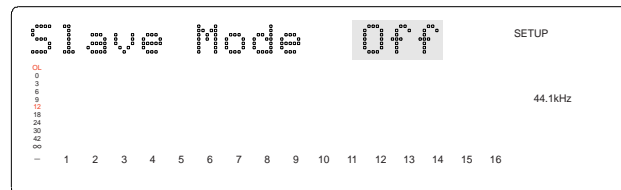

4. With the JOG dial, choose either “On” or “Off”.

If you choose “Off”, the slave function will not work.

5. Press EXECUTE/YES key after choosing the setting you want.

If you have chosen “Off”, the display will go back to step 2 described above.

However, if you have chosen “On”, as well as the display going back to step 2, the “CHASE” indicator on the display will start flashing.

This means that the Slave Mode has been set to On but, “Chase Lock” has not been achieved yet.

When the “Chase Lock” is completed, the “CHASE” indicator will stop flashing.

You can now choose which type of sync signal the D-160 should follow, after you have set this mode to On. Refer to next section “2-13. Slave Type Setting” for more details.

6. Press either the STOP button or EXIT/NO key to go back to the normal time base display before entering the SETUP mode.

2-13. Slave Mode Type Setting (“Slave Type?”)

If you have set the Slave Mode to ON in the previous section “2-12. Slave Mode Setting”, you can choose what type of external sync signal that the D-160 synchronizes to. This mode allows you to choose the external sync signal type.

* See Page "117" for MIDI synchronization for more details.

* Initial setting : Vari

* Available setting : Vari, SPDIF, adat, Free

* This setting is applicable song by song.

* This setting can be saved or loaded as a part of the song data.

* The setting is memorized even when the power is off.

* Make sure you choose the right program before setting up this mode.

* Make sure you choose the right sampling frequency before setting up this mode.

1. Press the **DISP SEL** key and choose the flashing **SETUP** mode on the display. Then, press the **EXECUTE/YES** key.

The **SETUP** display will stop flashing.

2. With the **JOG dial**, choose “Slave Type?”.

The “?” display will start flashing. The display will also show the current setting.

In the case of the initial setting, it will show Vari.

3. Press the **EXECUTE/YES** key.

The current setting will start flashing which indicates it is ready to change setting.

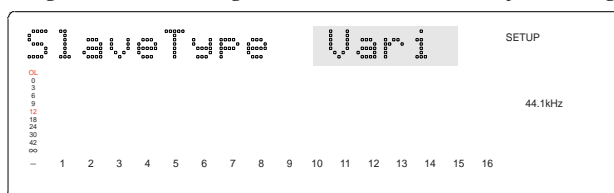

4. With the **JOG dial**, choose the setting you want.

If you choose “Vari”, the D-160 as a slave will only rely on the incoming MTC while synchronizing.

If you choose “SPDIF”, the D-160 will lock to the MTC first. Then, it will sync lock to the incoming SPDIF digital signal.

If you choose “adat”, the D-160 will lock to the MTC first, Then, it will sync lock to the incoming adat digital signal.

If you choose “Free”, the D-160 will freely play back on its own internal clock, after locking to the MTC.



<Note>

You need to connect an external MTC whatever type of sync signal you have chosen.

5. Press **EXECUTE/YES** key after choosing the setting you want.

The display will then go back to step 2 described above.



<Note>

If you have chosen either “SPDIF” or “adat” as a sync signal, the “DIGITAL” indicator on the display will light up provided the appropriate digital signal has been input. If the signal you input is not suitable for the setting, the display will start flashing “DIGITAL” and “FS” indicator. The FS means sampling frequency and it is only applicable to the SPDIF signal.

6. Press either the **STOP** button or **EXIT/NO** key to go back to the normal time base display before entering the **SETUP** mode.

* Press either the “STOP” button or EXIT/NO key to return from the second step menu to the first or to quit **SETUP** mode. The menu will go backwards each time you press either key so that you can correct the setting, choose some other **SETUP** mode or eventually return to the normal time base display.



<Notes>

* The re-chase window of the D-160 is fixed at 10 frames. This means that when the time difference (offset) between a master machine and the slave D-160 becomes larger than 10 frames, the D-160 will recognize it is out of chase lock and re-chase the position again. The D-160 will mute its audio during the re-chasing process. However, if the difference between two machines is less than 10 frames, the slave D160 will ignore the difference and run it as it is.

* The digital signal used with the Slave Mode is solely for sync lock. If you want to record a digital signal, follow the procedure as described in sections "2-15. Digital Input Track Setting". For your information, the digital signal you set with the "2-15. Digital Input Track Setting" for recording will override and be prioritized over the external sync signal which you have chosen this mode.

* The Vari Pitch function will be automatically OFF if you set the Slave Mode to ON.

* The D-160 will mute audio for about two seconds when it locks/unlocks the external sync source if you have chosen the slave type to "SPDIF" or "adat".

To avoid this problem, supply a reliable and stable digital source signal to the D-160.

2-14. Record Protect Setting ("Rec Protect?")

The D-160 carries a record prohibit function.

This function works as if you had removed the Record Protect tag from a conventional compact cassette tape. This mode allows you to choose either the ON or OFF function.

- * Initial setting : Off
 - * Available setting : Off, On
 - * This setting is applicable song by song.
 - * This setting can be saved or loaded as a part of the song data.
 - * The setting is memorized even when the power is off.
- * Make sure you choose the right program before setting up this mode.

1. Press the **DISP SEL** key and choose the flashing **SETUP** mode on the display. Then, press the **EXECUTE/YES** key.

The **SETUP** display will stop flashing.

2. With the **JOG** dial, choose "**Rec Protect?**".

The "?" display will start flashing.

3. Press the **EXECUTE/YES** key.

The display will start flashing either "Off" or "On" of current setting.

In the case of the initial setting, it will display "Off".

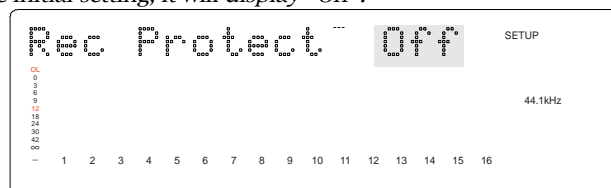

4. Choose either **On** or **Off** with the **JOG** dial.

If you choose "Off", there is no protection and you can record, paste, erase, etc. over it.

If you choose "On", there is protection and you cannot record, paste, erase, etc. over it.

5. Press the **EXECUTE/YES** key again to proceed.

* Press either the **STOP** button or **EXIT/NO** key to return from the second step menu to the first or to quit the **SETUP** mode. The menu will go backwards each time you press either key so that you can correct the setting, choose some other **SETUP** mode or eventually return to the normal time base display.



<Note>

If you set this mode to record protect, the D-160 will not perform such functions as recording, pasting or erasing. And it will show "Disable REC" on the display for one second as a warning message. Change the protect mode setting to "OFF" in this situation.

2-15. Digital Input Track Setting (“Digi. In?”)

This mode sets up the incoming digital signal to assign the D-160 recording track you have chosen. Using this function to digitally record from external digital equipment. The SPDIF stereo digital signal can assign D-160 tracks from track 1 to track 16 according to what pair you want.

In the case of adat digital signal input, this mode will assign 8 track adat signals to either tracks 1 ~ 8 or 9 ~ 16. You need to set the D-160 sampling frequency to match the incoming digital signal sampling frequency.

- * Initial setting : L- - R- - (Nothing is assigned on Lch and Rch)
- * Available setting : Lch = 1 ~ 16, adat, - -(No assign) Rch = 1 ~ 16, - - (No assign)
- * This setting is commonly applicable to all the programs .
- * This setting cannot be saved or loaded.
- * The setting is memorized even when the power is off.

<Notes>

- * The D-160 has two sets of DATA INPUT connectors: 1-8 and 9-16.
In the case of adat, change over the connection depending on which group of tracks you want to assign the digital signal to. In the case of SPDIF, the signal input can only be done via the DATA INPUT 1-8 connector. Do not use the 9-16 connector. The input signal will be applicable to all 16 tracks.
- * The D-160 will mute audio for about two seconds when it locks/unlocks the external sync source if you have chosen the slave type to “SPDIF” or “adat”. To avoid this, supply a reliable and stable digital source signal to the D-160.

<Important>

- * Again, remember that you need to set the D-160 sampling frequency to match the incoming digital signal sampling frequency.
- * The D-160 cannot record digitally if the D-160 sampling frequency is different from the incoming SPDIF digital signal sampling frequency.
- * In the case of the adat digital signal input, the D-160 will record the signal digitally but with the incorrect speed. This is because, when the D-160 has been set up with this mode ON, the D-160 will be working in the external word clock sync mode, i.e. incoming SPDIF or adat signal clock timing runs the D-160 internal clock rather than the D-160's own internal clock. In the case of the SPDIF signal, it contains the sampling frequency information in the signal itself. So, the D-160 will recognize if the incoming sampling frequency is different from the one set up in the D-160 and refuse to synchronize to it. However, an adat signal does not contain this sampling frequency info as in the standard. The D-160 will ignore the sampling frequency difference and synchronize with the incorrect rate and record at the wrong speed.

1. Press the DISP SEL key and choose the flashing SETUP mode on the display. Then, press the EXECUTE/YES key.

The SETUP display will stop flashing.

2. With the JOG dial, choose “Digi.In?”.

The “?” display will start flashing. The display will also show the current setting. In the case of the initial setting, it will show “L- - R- -”.

3. Press the EXECUTE/YES key.

The current assign setting on the Lch will start flash asking you to choose the setting you want.

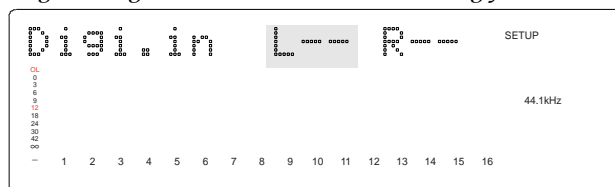

4-A. In the case of SPDIF signal input, enter whichever two tracks you want with the JOG dial.

Use either the HOLD/> key or SHUTTLE dial to move the flashing Channel display between Lch and Rch.

Available track settings are tracks 1 ~ 16 and “- -” which means no tracks are assigned.

<Note>

You cannot assign the same track to both Lch and Rch. If you accidentally do this, the later setting will be effective and the D-160 will automatically cancel the previous track assignment to “- -”, so that nothing is assigned there. The later setting will always be prioritized.

* The D-160 can also record only one channel from the stereo SPDIF signal.

For example, if you assign Lch to track 4 and Rch to NIL, “L04 R- -”, the D-160 will record only SPDIF Lch on track 4.

4-B. For an adat digital signal, enter “adat” with the JOG dial after making the Lch flash with either the HOLD/> key or SHUTTLE dial.

You cannot choose “adat” when the Rch is flashing.

* The adat digital input signal will be assigned as DATA INPUT 1-8 to tracks 1 ~ 8 and DATA INPUT 9-16 to tracks 9 ~ 16 accordingly.

* For analog input, you need to select nothing on either the Lch and Rch.

5. Press the EXECUTE/YES key to register the tracks you have chosen.

The display will go back to the display of item 2.

When the D-160 recognizes an incoming digital signal correctly, the red “digital” display will stop flashing.

* If the red “DIGITAL” indication is flashing, check the connection and cable between D-160 and the external digital equipment.



<Notes>

* If you set up the wrong sampling frequency for the incoming SPDIF, the display will flash either 44.1k or 48kHz on the FS indicator as a warning message.

* For adat signal input, there is no warning message indication. Be careful of the frequency sampling setting.

6. Press the STOP button or EXIT/NO key to exit this mode.

* Press either the STOP button or EXIT/NO key to return from the second step menu to the first or to quit SETUP mode. The menu will go backwards each time you press either key so that you can correct the setting, choose some other SETUP mode, or eventually return to the normal time base display.



<Notes>

* Tracks assigned for digital input will become exclusively digital input only. Hence no analog recording on those tracks is possible. If you want to use some D-160 tracks for analog input, you have to select “- -” in both the Lch and the Rch or assign some other tracks. In the “adat” setting, either tracks 1-8 or 9-16 will automatically be assigned for digital input. So, the tracks which have not been assigned can still be used for analog recording. For example, if you connect the adat signal to DATA INPUT 1-8, you can record digital on tracks 1-8 and analog on tracks 9-16. The D-160 can manage digital/analog 16 track simultaneous recording.

* Vari Pitch function will be automatically OFF (No LED lights up), when you set up this digital input mode.

* The input digital signal you choose in this mode will override the type of external sync signal you might have chosen with “2-12. Slave Mode Setting” such as Vari, SPDIF, adat or Free. Therefore, the D-160 will ignore the Slave Mode setting and the slave function will become the sync lock synchronization with the chosen input digital signal in this mode.

2-16. Digital Out Track Setting (“Digi. out?”)

This mode sets up the outgoing digital signal from the D-160 with what type and which recorded tracks. The D-160 can digitally transmit the recorded audio as it is to external digital equipment. When you use this function, set the identical sampling frequency on the external digital equipment as the D-160 sampling frequency.

- * Initial setting : adat
- * Available setting : adat, Lch 1 ~ 16, Rch 1 ~ 16
- * This setting is commonly applicable to all programs.
- * This setting cannot be saved or loaded.
- * The setting is memorized even when the power is off.



<Note>

S/P DIF output (1 ~ 16) will all be output from DATA OUTPUT 1-8.
DATA OUTPUT 9-16 is constantly fixed to "adat" output.

1. Press the **DISP SEL** key and choose the flashing **SETUP** mode on the display. Then, press the **EXECUTE/YES** key.

The **SETUP** display will stop flashing.

2. With the **JOG** dial, choose “**Digi.out?**”.

The “?” display will start flashing. The display will also show the current setting.
In the case of the initial setting, it will show “adat”.

3. Press the **EXECUTE/YES** key.

The current setting will start to flash which indicates it is ready to change setting.

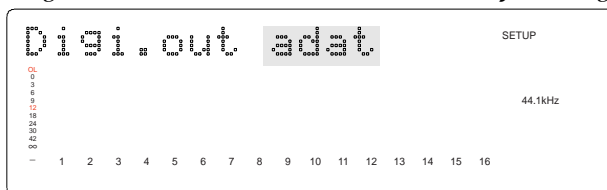

- 4-A. If you want to choose an **SPDIF** digital signal, when the **Lch** display is flashing, choose the track you want with the **JOG** dial.

Then, use the **HOLD/>** key or **SHUTTLE** dial to move to the **Rch**. Using the same method for choosing the **Lch**, choose the track in the **Rch**.

If you choose normal numerical pairs such as “L01-R02”, “L03-R04”, “L13-R14”, “L15-R16”, a two channel stereo signal will be transmitted in **SPDIF** digital audio format.

In this case, the odd channels will be directed to the **Lch** and even channels to the **Rch** accordingly.



<Note>

You cannot assign the same track to both **Lch** and **Rch**. If you accidentally do this, the **Lch** setting will be effective and the D-160 will automatically cancel the **Rch** track assignment to “-” as nothing is assigned. For example, if you chose channel 02 for both **Lch** and **Rch** and pressed the **EXECUTE/YES** key, the D-160 would automatically assign as “L02 - R-”.

- 4-B. In the case that you want to choose an **adat** signal, when the **Lch** display is flashing, choose “**adat**” with the **JOG** dial. As you cannot choose “**adat**” while the **Rch** display is flashing, use the **HOLD/>** key or **SHUTTLE** dial to move to the **Lch**.

All 16 track signals will be transmitted in **adat** digital format.

- * The **adat** digital output signal will be assigned as tracks 1 ~ 8 to **DATA OUTPUT** 1-8 and tracks 9 ~ 16 to **DATA OUTPUT** 9-16 accordingly.

5. Press the **EXECUTE/YES** key to register the tracks you have chosen.

The display will go back to the display of Item 2.

6. Press the **STOP** button or **EXIT/NO** key to come out of this mode.

- * Press either the **STOP** button or **EXIT/NO** key to return from the second step menu to the first or to quit **SETUP** mode. The menu will go backwards each time you press either key so that you can correct the setting, choose some other **SETUP** mode or eventually return to the normal time base display.

* All the analog output tracks are available regardless of the above settings.

2-17. Bar/Beat Resolution Mode Setting (“↓ Resolution?”)

This mode sets up the display resolution mode in either “ON” or “OFF”.

If you set this mode to “ON”, the D-160 will register the memory points rounding up or down so that clock digits are always kept at 00. This mode is only relevant when you choose Bar/Beat/Clock as a time base.

This function is very useful for edit functions such as copy paste or move paste when you use the Bar/Beat/Clock as the time base. For example, when you register a memory point that picks up a real time in play mode, you press the STORE button and then some memory keys. The position you choose will be automatically corrected based on the Bar/Beat resolution. The position will always register in clock accuracy. This setting is memorized even when the power is off.

* For example, if you are to register 001 Bar 1 Beat 46 Clock to the CLIP BOARD IN point and 002 Bar 4 Beat 51 Clock to the CLIP BOARD OUT point, if the resolution mode is set, the actual memory will be corrected in the following key. This example is mentioned based on the time signature of a 4/4 Beat.

001 Bar 1 Beat 46 Clock -> 001 Bar 1 Beat 00 Clock : round down on clock
002 Bar 4 Beat 51 Clock -> 003 Bar 1 Beat 00 Clock : round up on clock

- * Initial setting : Off
- * Available setting : Off, On
- * This setting is commonly applicable to all the programs.
- * This setting cannot be saved or loaded.
- * The setting is memorized even when the power is off.

1. Press the DISP SEL key and choose the flashing SETUP mode on the display. Then, press the EXECUTE/YES key.

The SETUP display stops flashing.

2. With the JOG dial, choose “↓ Resolution?”.

The “?” display will start flashing. The display will also show the current setting. In the case of the initial setting, it will show “Off”.

3. Press the EXECUTE/YES key.

The current setting will start flashing which indicates it is ready to change setting.

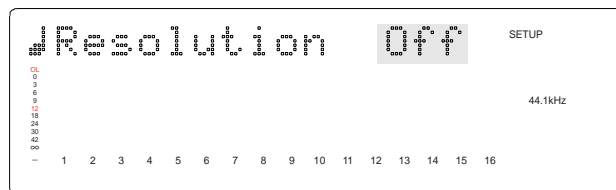

4. With the JOG dial, choose either “On” or “Off”.

If you choose “Off”, the slave function will not work.

If you choose “On”, the clock will be rounded up or down always ending in 00.

5. Press EXECUTE/YES key after choosing the setting you want.

The display will go back to the display of item 2.

* Press either the STOP button or EXIT/NO key to return from the second step menu to the first or to quit SETUP mode. The menu will go backwards each time you press either key so that you can correct the setting, choose some other SETUP mode or eventually return to the normal time base display.

2-18. MIDI Device ID Setting (“Device ID?”)

This mode sets up the MIDI device ID number on the D-160.

The set ID applies to both receiving and transmitting when an external sequence software controls the D-160 via MMC or the Fostex system Exclusive Message.

This mode is necessary to arm the slave machine record track selectors from the master machine. The available device ID is between 00 and 99. But, if the D-160 receives a message with ID No 7F, The D-160 will recognize it and follow the command regardless of the device ID setting.

- * Initial setting : 00
- * Available setting : 00 ~ 99
- * This setting is applicable to all programs.
- * This setting cannot be saved or loaded.
- * The setting is memorized even when the power is off.

1. Press the **DISP SEL** key and choose the flashing **SETUP** mode on the display. Then, press the **EXECUTE/YES** key.

The **SETUP** display will stop flashing.

2. With the **JOG dial**, choose “**Device ID?**”.

The “?” display will start flashing.

The display will also show the current setting. In the case of the initial setting, it will show “00”.

3. Press the **EXECUTE/YES** key.

The current setting will start flashing “**” which indicates it is ready to change setting.

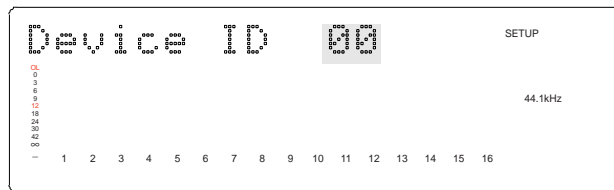

4. With the **JOG dial**, enter a required ID number.

The available setting is from 00 ~ 99.

5. Press the **EXECUTE/YES** key once again.

The setting will be registered and the display will go back to step 2.

* Press either the **STOP** button or **EXIT/NO** key to return from the second step to the first or to quit **SETUP** mode. The menu will go backwards each time you press either key so that you can correct the setting, choose some other **SETUP** mode or eventually return to the normal time base display.

2-19. Sampling Frequency Setting (“Sample Rate?”)

The D-160 can handle two types of sampling frequency, either 44.1k or 48 kHz. This mode allows you to set either sampling frequency. The display will show the registered sampling frequency.

- * Initial setting : 44.1kHz
- * Available setting : 44.1kHz, 48kHz
- * This setting is applicable song by song.
- * This setting can be saved or loaded as a part of the song data.
- * The setting is memorized even when the power is off.

1. Press the DISP SEL key and choose the flashing SETUP mode on the display.

Then, press the EXECUTE/YES key. The SETUP display stops flashing.

2. With the JOG dial, choose “Sample Rate?”.

The “?” display will start flashing. The display will also show the current setting. In the case of the initial setting, it will show “44.1”.

3. Press the EXECUTE/YES key.

The current setting will start flashing which indicates it is ready to change setting.

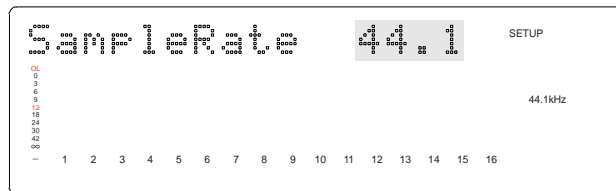

4. With the JOG dial, choose either “44.1” or “48” .

5. Press the EXECUTE/YES key to process.

The setting will be registered and the display will go back to step 2. Or If you are not changing the sampling frequency, press the EXIT/NO key or STOP button to quit the SETUP mode.

6. Press the STOP button or EXIT/NO key to come out of this mode.

The display will go back to the normal time base display.

* Press either the STOP button or EXIT/NO key to return from the second step menu to the first or to quit SETUP mode. The menu will go backwards each time you press either key so that you can correct the setting, choose some other SETUP mode or eventually return to the normal time base display.



<Notes>

- * The total recording length will be shorter with 48kHz sampling than 44.1kHz sampling due to the hard disk space usage. The REMAIN time display will be shorter with 48kHz than 44.1kHz as well.
- * Except for certain special use, avoid changing the sampling frequency within a program . It is possible to set the D-160 to a different sampling frequency than its original song recording frequency. However, the play back speed will become different from the original and the registered memory key data will become a different value.

2-20. Event Number Check on Each Track (“NOs Of Event?”)

This mode allows you to check event numbers on each recorded track individually. As we have described in the “Before Operation” section, each recorded track data (TRK 1 ~ 24) on a program is made up with the Audio Files and O Files. The event number is calculated by adding these two types of Files. The D-160 is able to carry up to 512 events per track. When the event numbers exceed 508, the D-160 will no longer be able to record new data. This situation is called “event over”.

For an ordinary song length, about 6 minutes, however intense the editing process is, you should never experience an event over problem. This is because the D-160 automatically tries to optimize the disk management system as much as possible so that the event numbers are always kept minimum.

However, you need to be careful in certain circumstances as:

- * when recording short lengths of audio bit by bit in many separate places.
- * when taking advantage of a D-160 feature in which you can record wherever you like within the 24 hours in ABS.
- * when doing lot of editing on a very long mono track recording.

This mode is especially useful to check the data stored in the virtual tracks as the data transferred to virtual tracks cannot be seen.

1. Press the DISP SEL key and choose the flashing SETUP mode on the display. Then, press the EXECUTE/YES key.

The SETUP display will stop flashing.

2. With the JOG dial, choose “NOs Of Event?”.

The “?” display will start flashing.

3. Press the EXECUTE/YES key.

The display will show the actual event number of track one.

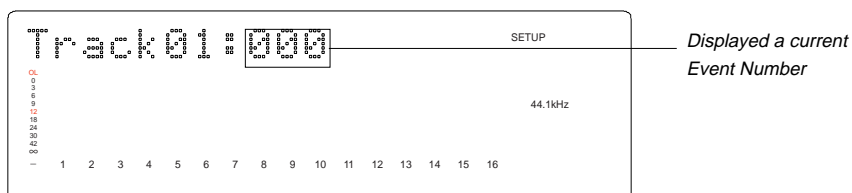

4. By turning the JOG dial, the display will show the track numbers one after the other so that you can check the event number on each track.

5. Press the EXIT/NO key or STOP button to quit the SETUP mode.

* Press either the STOP button or EXIT/NO key to return from the second step menu to the first or to quit SETUP mode. The menu will go backwards each time you press either key so that you can correct the setting, choose some other SETUP mode or eventually return to the normal time base display.

* For details on audio files and events, refer to "2. Audio File and Event" in "Before operating."

2-21. Current Drive Setting (“Drive Sel.?”)

The “Current Drive” here means the medium drive device, either the internal IDE or SCSI, to be used in real time recording or playing back.

For example, you need to set this mode to “SCSI” if you want to directly record data on to the external SCSI device at real time or enter a title in the song number/back up number on the SCSI device.

This mode allows you to choose the current drive from either the internal IDE hard disk which is installed in the D-160, or a SCSI device which is externally connected.

If you choose the SCSI device whose medium has not been formatted, the D-160 will automatically recognize it as an “unformatted medium” and move on to the “Disk Format?” menu in the SETUP mode.

Then, after completing the format process, the “SCSI” will be chosen as the current drive.

- * Initial setting : IDE (internal hard disk)
- * Available setting : IDE, SCSI
- * The setting will go back to “IDE” when you turn the power to off.

1. **Press the DISP SEL key and choose the flashing SETUP mode on the display. Then, press the EXECUTE/YES key.**

The SETUP display will stop flashing.

2. **With the JOG dial, choose “Drive Sel.?”.**

The “?” display will start flashing. The display will also show the current setting. In the case of the initial setting, it will show “IDE”.

3. **Press the EXECUTE/YES key.**

The current setting will start flashing which indicates it is ready to change setting.



4. **With the JOG dial, choose either “IDE” or “SCSI” you want.**

5. **Press EXECUTE/YES key after choosing the setting you want.**

The display will go back to the display of item 2.

* Press either the STOP button or EXIT/NO key to return from the second step menu to the first or to quit SETUP mode. The menu will go backwards each time you press either key so that you can correct the setting, choose some other SETUP mode or eventually return to the normal time base display.



<Notes>

- * When you are to choose “SCSI” as the current drive, the display will show “Initializing” then, “No SCSI Device!” and go back to the display of Item 2 if the power of the externally connected SCSI device is not turned ON, or if it is not connected properly. Similarly, the display will show “No Disk!” if the SCSI device does not have a medium inserted correctly.
- * To eject the medium from the SCSI device, press the EXIT/NO key while holding down the STOP button with the normal time base display.

2-22. Loading Song Data (“Load PGM?”)

Prior to loading externally saved song data back on to the D-160 internal hard disk drive, this mode allows you to choose which DAT, adat or SCSI port will be used.

* See page "102" “Saving/Loading Song Data” for details of Loading Song Data.

* Available setting : adat, DAT, SCSI

* Available program : P1 ~ P99 or ALL (In the case of SCSI only)

* You can load one program or all the programs (in the case of SCSI only).

1. Press the DISP SEL key and choose the flashing SETUP mode on the display.

Then, press the EXECUTE/YES key. The SETUP display will stop flashing.

2. With the JOG dial, choose “Load PGM?”.

The “?” display will start flashing.

3. Press the EXECUTE/YES key.

The display will show “LOAD”.

The display will also show the current setting. In the case of initial setting, it will show “DAT”.

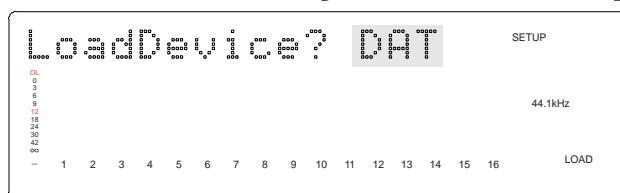

4. With the JOG dial, choose which type digital signal you want to use to load song data.

If you choose “adat”, the song data will be loaded via adat digital signal.

If you choose “DAT”, the song data will be loaded via SPDIF digital signal.

If you choose “SCSI”, the song data will be loaded via SCSI.

Load from “DAT”

5-a. Choose DAT with the JOG dial and press the EXECUTE/YES key.

The display will show “LOAD” and be flashing “SURE?”. The display will also start flashing the currently chosen load target program number on the internal hard disk drive, which you are loading the song data back on to.

6-a. With the JOG dial, choose the program number onto which you want to load on to.

You can choose any program available on the internal IDE drive to load song data on to.

If you want to load the data onto a new program rather than the program already available, choose “New PGM” at this stage.

7-a. Press the EXECUTE/YES key. The display will show “LOAD”.

The display will also start to show the menu from which you can choose the tracks you want to load on to. Choose the setting with the JOG dial.

The available loading track settings are ;

1-8, 1-16, 1-24, 9-16, 9-24, 17-24. We recommend you choose the loading tracks in the same way as when you saved the data.

8-a. Press the EXECUTE/YES key after you have chosen the tracks you want.

The display will start flashing “SURE?”.

9-a. Press the EXECUTE/ YES key once again.

The display will show “Play DAT?”. This means the D-160 is asking you to start playing back the DAT machine connected to the D-160, which has a tape recorded with the song data.

10-a. Start playing back the DAT.

The display will start showing “REMAIN”.

In few seconds, the D-160 will recognizes the pilot signal from the DAT. The display will then start showing the program number you are loading the data to and the count down time display indicating how long the load process is going take. The D-160 has now started loading the data. The actual load process starts at the moment the display starts showing the count down time. Loading from DAT is done via using a pair of stereo signals one after the other, e.g. 1-2 then 3-4 then....23-24. While loading, the D-160 will display track 1 and 2 indicators flashing with their level meters moving.

11-a. When the D-160 has successfully loaded song data, "COMPLETED!" will be displayed.

Press the EXIT/NO key to cancel the message and return to the normal time base display.

* Press either the STOP button or EXIT/NO key to return from the second step menu to the first or to quit SETUP mode. The menu will go backwards each time you press either key. If you press these keys after you have started the loading process at Item 10, only the data that has already been loaded will be effective. The data that has not been loaded yet will be void.

Load from "adat"

5-b. Choose "adat" with the JOG dial and press the EXECUTE/YES key.

The display will show "LOAD" and flashing "SURE?". The display will also start to flash the currently chosen load target program number on the internal hard disk drive, which you are loading the song data back to.

6-b. With the JOG dial, choose the program number which you want to load on on to.

You can choose any program available on the internal IDE drive to load song data to. If you want to load the data onto a new program rather than the program already available, choose "New PGM" at this stage.

7-b. Press the EXECUTE/YES key. The display will show "LOAD".

The display will also start showing the menu from which you can choose the tracks you want to load on to. Choose the setting with the JOG dial.

The available loading track settings are ;

1-8, 1-16, 1-24, 9-16, 9-24, 17-24. We recommend you should choose the loading tracks in the same way as when you saved the data.

8-b. Press the EXECUTE/YES key after you have chosen the tracks you want.

The display will start flashing "SURE?".

9-b. Press the EXECUTE/ YES key once again.

The display will show "Play adat!". This means the D-160 is asking you to start playing back the adat machine connected to the D-160, which has a tape recorded with the song data.

10-b. Start playing back the adat.

The display will show "REMAIN". For your information, you need to set the clock source of the adat unit as INTERNAL when you play back the tape.

In a few seconds, the D-160 recognizes the pilot signal from the adat.

The display will then start showing the program number to loading to and the counting down time display indicating how long the load process is going take. The D-160 has now started loading the data. The actual load process is start at the moment the display starts showing count down time.

Loading from adat is done via using an 8 track adat signal one after the other, e.g. 1-8 then 9-16 then 16-24. While loading, the D-160 will display track 1-8 indicators flashing with their level meters moving.

11-b. When the D-160 has successfully loaded song data, "COMPLETED!" will be displayed.

Press the EXIT/NO key to cancel the message and return to the normal time base display.

* Press either the STOP button or EXIT/NO key to return from the second step menu to the first or to quit SETUP mode. The menu will go backwards each time you press either key. If you press these keys after you have started loading process at Item 10, only the data that has been loaded will be effective. The data that has not been loaded yet will be void.

Load from "SCSI" (Song Data Load)

5-c. Choose "SCSI" with the JOG dial and press the EXECUTE/YES key.

The display will show "LOAD". The display will also start to flash the currently chosen load source song number saved on the SCSI drive, which you are loading the data from.

6-c. With the JOG dial, choose a song number you want to load.

You can choose any ONE or ALL of the programs (songs) available in the external SCSI drive to load the data from.

7-c. Choose the song number with the JOG dial and press the EXECUTE/YES key.

The display will show "LOAD" and flash "SURE?". The display will also start to flash the currently chosen load target program number on the internal hard disk drive.

With the JOG dial, choose a program which you want to load the song data back on to. If you choose a program which has no data, the display will show "OMB". If you want to load the data onto a new program rather than to the program already available, choose "New PGM".

8-c. Press the EXECUTE/YES key after you have chosen the program number.

The D-160 will start loading the song data you have chosen in 6-c to the program number you have chosen in 7-c.

When the D-160 has successfully loaded song data, "COMPLETED!" will be displayed.

Press the EXIT/NO key to cancel the message and return to the normal time base display.



Warning

Be careful that If you choose "ALL" in the loading song/program options and start loading the data, all the prerecorded material stored in the internal hard disk will be erased even though you have set the "Rec Protect" mode to ON in the SETUP mode.

Load from "SCSI" (Back Up Data Load)

The example described here is loading back up data "B01" which is saved on to two SCSI disks. Let's assume the first disk (DISK 1) has already been inserted in the SCSI device.

5-d. Choose "SCSI" with the JOG dial and press the EXECUTE/YES key.

The display will show "LOAD".

The D-160 will also show "B01[Title] D1" on the display, which means;

B01 (flashing) : back up number currently chosen on the loading source

D1 : disk number 1

6-d. Press the EXECUTE/YES key once again.

The display will start flashing "SURE?".

The display will also start flashing the currently chosen load target program number on the internal hard disk drive. With the JOG dial, choose a program which you want to load the song data back on to. If you choose a program which has no data, the display will also show "OMB".

If you want to load the data to a new program rather than to the program already available, choose "New PGM" at this stage.

7-d. Press the EXECUTE/YES key after you have chosen the program number.

The D-160 will start loading the back up data "B01" onto the program number you chose in 6-d.

When finishing loading data from the first disk, the D-160 will show "Insert Disk 2" and eject Disk 1 automatically.

8-d. Insert the second disk in the SCSI device.

The D-160 will automatically start loading from the second disk.

When the D-160 has successfully loaded the song data, "COMPLETED!" will be displayed.

Press the EXIT/NO key to cancel the message and return to the normal time base display.

* Press either the STOP button or EXIT/NO key to return from the second step menu to the first or to quit SETUP mode. The menu will go backwards each time you press either key. If you press these keys after you have started the loading process, only the data that has already been loaded will be effective. The data that has not yet been loaded will be invalid.

2-23. Saving Song Data (“Save PGM?”)

Prior to saving song data onto the externally connected device, this mode allows you to choose which DAT, adat or SCSI port will be used.

* See page "102" “Saving/Loading Song Data” for details of saving Song Data.

* Available setting : adat, DAT, SCSI

* Available program : P1 ~ P99 or ALL (In the case of SCSI only)

* You can load one program or all the programs (in the case of SCSI only).

1. Press the **DISP SEL** key and choose the flashing **SETUP** mode on the display. Then, press the **EXECUTE/YES** key.

The **SETUP** display will stop flashing.

2. With the **JOG dial**, choose “**Save PGM?**”.

The “?” display will start flashing.

3. Press the **EXECUTE/YES** key.

The display will show “**SAVE**”. The display will also show the current setting.

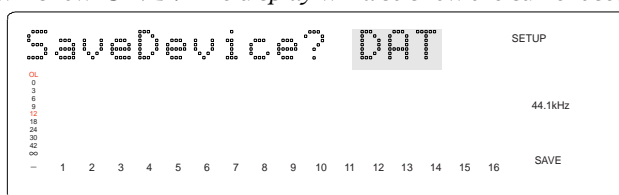

4. With the **JOG dial**, choose which type digital signal you want to use to save song data.

If you choose “**adat**”, the song data will be saved via adat digital signal.

If you choose “**DAT**”, the song data will be saved via SPDIF digital signal.

If you choose “**SCSI**”, the song data will be saved via SCSI.

Save to “**DAT**”

- 5-a. Choose “**DAT**” with the **JOG dial** and press the **EXECUTE/YES** key.

The display will show “**SAVE**”. The display will also start flashing the current program number on the internal hard disk drive, which you are saving the song data from.

- 6-a. With the **JOG dial**, choose the program number which you want to save.

You can choose any program available in the internal IDE drive to save the song data.

- 7-a. Press the **EXECUTE/YES** key after you have chosen the program.

The display will show “**SAVE**”. The display will also show the recorded program length “Length? **m**s”. This length is limited up to 59 minutes 59 seconds.

If you want to save the full length of the recorded data, follow the procedure below.

However, you can also edit the song length to be saved, which means either increasing or decreasing it, at this stage.

- 8-a. Press the **EXECUTE/YES** key once again. The display will show “**SAVE**”.

The display will also start to show the menu from which you can choose the tracks that you want to save. Choose the setting with the **JOG dial**.

Available loading track settings are ;

1-8, 1-16, 1-24, 9-16, 9-24, 17-24.

- 9-a. Press the **EXECUTE/YES** key after you have chosen the tracks you want.

The display will start flashing “**SURE?**”.

The display will also show “**Rec Start DAT!**”. This means the D-160 is asking you to start recording onto the DAT machine connected to the D-160, which has a tape you will record the song data on to.

- 10-a. Start recording **DAT** first then press the **EXECUTE/YES** key afterwards.

The display will start showing “**REMAIN**”.

In few seconds, the display will start showing the count down time display indicating how long the save process is going take. The D-160 has now started saving the data.

The actual save process starts at the moment the display starts showing the count down time. Saving to **DAT** is done via using a pair of stereo signals one after the other, e.g. 1-2 then 3-4 then....23-24.

11-a. When the D-160 has finished saving the song data, it will display "COMPLETED!" and then return to the normal time base display.

* Press either the STOP button or EXIT/NO key to return from the second step menu to the first or to quit SETUP mode. The menu will go backwards each time you press either key. If you press these keys after you have started the saving process in 8, only the data that has already been saved will be effective. The data that has not been saved yet will be invalid.

Save to "adat"

5-b. Choose "adat" with the JOG dial and press the EXECUTE/YES key.

The display will show "SAVE". The display will also start flashing the current program number on the internal hard disk drive, which you are saving the song data from.

6-b. With the JOG dial, choose the program number which you want to save.

You can choose any program available on the internal IDE drive to save the song data.

7-b. Press the EXECUTE/YES key after you have chosen the program.

The display will show "SAVE". The display will also show the recorded program length "Length? **m**s". This length is limited up to 59 minutes 59 seconds.

If you want to save the full length of the recorded data, follow the procedure below. However, you can also edit the song length to be saved, which means either increasing or decreasing it, at this stage.

8-b. Press the EXECUTE/YES key once again. The display will show "SAVE".

The display will also start showing the menu from which you can choose the tracks you want to save. Choose the setting with the JOG dial. Available loading track settings are ;

1-8, 1-16, 1-24, 9-16, 9-24, 17-24.

9-b. Press the EXECUTE/YES key after you have chosen the tracks you want.

The display will start flashing "SURE?".

The display will also show "Rec Start adat!". This means the D-160 is asking you to start recording onto the adat machine connected to the D-160, which has a tape you will record with the song data.

10-b. Start recording adat first then press the EXECUTE/YES key afterwards.

The display will start showing "REMAIN".

In a few seconds, the display will start showing the count down time display indicating how long the save process is going take. The D-160 has now started saving the data.

The actual save process starts at the moment the display starts showing the count down time. Saving to adat is done via using an 8 track signal one after the other, e.g. 1-8 then 9-16 then 17-24.

11-b. When the D-160 has finished saving song data, it will display "COMPLETED!" and then return to the normal time base display.

* Press either the STOP button or EXIT/NO key to return from the second step menu to the first or to quit SETUP mode. The menu will go backwards each time you press either key. If you press these keys after you have started the saving process in 10, only the data that has already been saved will be effective. The data that has not been saved yet will be invalid.

Save to "SCSI" (Program by Program)

5-c. Choose "SCSI" with the JOG dial and press the EXECUTE/YES key.

The display will show "SAVE". The display will also start flashing the current program number on the internal hard disk drive, which you are saving the song data from, e.g. "P02[Title]".

6-c. With the JOG dial, choose the program number which you want to save.

You can choose any program available in the internal IDE drive on which to save the song data. (See next section if you want to save ALL the programs at once .)

As far as saving is concerned, there are two types of program available:

One is a type of program whose data can fit on only one disk and another is one that requires more than two disks. The display will appear as follow.

* A program that displays only the program number. This type of program can be saved on one disk, e.g. "P02 [Title]".

*** A program that displays the program number and the indicator “*D” after the program number. This type of program requires more than two disks to save, e.g. “P03[Title]2D”. “2D” means it needs two disks to save.**

7-c. Press the EXECUTE/YES key after you have chosen the program you want. The display will show “SAVE”.

*** If you choose the program that can be saved using one disk only:**

The display will show the current song number (S**) and its available memory size on the SCSI disk, e.g. “S01[Title]0MB” with “SURE?” flashing.

This means you are saving song data whose number is 01 onto a SCSI disk which has OMB, i.e. nothing stored. Press the EXECUTE/YES key to proceed.

*** If you choose the program that requires more than two disks to save:**

The saving will start immediately after you have pressed the EXECUTE/YES key. For example, if you choose the program containing “P01[Title]2D”, the display will show “P01>>B01-***MB”.

Then, by the time saving is in progress, “-***MB” will be counting down.

The “B01” here means that the data which is being saved to the SCSI device is so called back up data and the allocated number as “01”.

When finishing saving data to the first disk, the D-160 will show “Insert Disk 2” and eject Disk 1 automatically.

When you insert the second disk in the SCSI device, the D-160 will continue saving the remaining data with the same back up number.

When the D-160 has successfully saved song data, “COMPLETED!” will be displayed. Press the EXIT/NO key to cancel the message and return to the normal time base display.



<Notes>

- * Unlike saving to DAT or adat, saving song data to SCSI cannot stop in the middle of saving.
- * If you want to change the title of the song data you are saving to SCSI, use “2-20. Drive Sel?” to switch over the current drive to “SCSI” and proceed with “2-4. Title Edit?” in the SETUP mode.
- * When you are choosing “Save All” or saving song data on more than two disks on the SCSI device, if you try to save on a disk which already has some data recorded, the D-160 will ask you whether you want the D-160 to erase all the data completely, e.g. the display will show “B01[Title]DEL” or “S01[Title]DEL” with “SURE ?” flashing. Press the EXECUTE/YES key if you don’t mind the disk being overwritten. But, if you do, press the EXIT/NO key or STOP button to quit the mode and insert the correct disk. To eject the disk, press the EXIT/NO key while holding down the STOP button.

Save to “SCSI” (Save All)

5-d. Choose “SCSI” with the JOG dial and press the EXECUTE/YES key.

The display will show “SAVE”. The display will also start flashing the current program number on the internal hard disk drive, which you are saving the song data from, e.g. “P02[Title]”.

6-d. With the JOG dial, choose “Save All”.

The display will show “Save All? (**/**)”, which indicates the numbers of programs you are saving and the numbers of programs that the current SCSI disk can save. For example, if the display shows “03/03”, this means that there are a total of three programs to be saved and all three programs can be saved to the current disk. However, if the display shows “01/03”, this means that there are a total of three programs to be saved but only one program can be saved. Or if the display shows “00/03”, none of the available programs can be saved due to the shortage of SCSI disk space. In this last case, even though you press the EXECUTE/YES key to try to save the song data, the D-160 cannot proceed with saving and will display “Void Command!” as a warning message.

Basically, it is not possible to use more than two disks for saving the data with the “Save All” option, unlike the “Program by Program” option described in the previous section. Therefore, you have to find a large enough disk or try to save the data program by program.

7-d. Press the EXECUTE/YES key. The display will show “SAVE”.

The data which is being saved is called Song Data with the “Save All” option rather than back up data with the “Program by Program” option.

So, P1 in the internal IDE drive will be saved as S1, P2 as S2, etc. All the programs will be saved in the same way.

When the D-160 has finished saving song data, it will display "COMPLETED!" and then return to the normal time base display.

2-24. Formatting IDE/SCSI disk ("Disk Format?")

When you format or initialize the internal hard disk or externally connected SCSI device, use this "Disk Format?" menu. If the formatting has been completed, all the recorded song data will be wiped off completely and the hard disk setting will go back to the initial factory setting. You need to format a brand new IDE hard disk or SCSI disk before you start using them.

* See page "39" for details of the Removable Hard disk Cartridge and the replacing Hard disk.

* See page "108" for details of the Handling SCSI disk.

1. **Press the DISP SEL key and choose the flashing SETUP mode on the display.**
Then, press the EXECUTE/YES key. The SETUP display will stop flashing.
2. **With the JOG dial, choose "Disk Format?".**
The "?" display will start flashing. The display will also show the current setting.
3. **Press the EXECUTE/YES key.**
The current setting will start flashing which indicates it is ready to change setting.

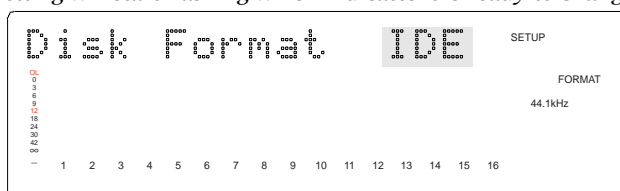

4. **With the JOG dial, choose the "IDE" or "SCSI" you want.**
5. **Press EXECUTE/YES key after choosing the setting you want.**
The display will show the drive you have chosen. Also, the D-160 will ask you whether you want to proceed with formatting by displaying the message "SURE?".

* If you want to cancel the format, press the EXIT/NO key at this stage. If you proceed with the operation described in step 6 below, you will not be able to stop formatting.

6. **If you really want to format, press the EXECUTE/YES key.**
If you have chosen "IDE", the format process will start immediately. The display will start showing "REMAIN" and the count down memory space display (MB) indicating how long the formatting process is going take.



Warning

Once the formatting starts, there is no way to stop it. Even the EXIT/NO key or STOP button won't help you! If you don't want to lose the recorded data, never press the EXECUTE/YES key at this stage.

If you have chosen "SCSI", the formatting process will still not start. But instead, the display will show the Format Type which the D-160 has automatically measured on the externally connected SCSI device.

We recommend you format the disk with this Format Type. However, you can also change the Format Type with the JOG dial at this stage.

Press the EXECUTE/ YES key after you have chosen the Format type you want.

Now the format process on the SCSI will start.

7. **When the format finishes, the display will show "COMPLETED!" in either case.**
8. **Press the STOP button or EXIT/NO key to quit the SETUP mode and return to the normal time base display.**

(Digital Multitrack Recorder)

Model D-160

MIDI Implementation Chart

Date:

Version : V1.00

| Function..... | Transmitted | Recognized | Remarks | |
|--|--|------------------|------------------|--|
| Basic Channel | Default Changed | × × | × × | |
| Mode | Default Message Altered ***** | × × × | × × × | |
| Note Number : | True voice | × | × × | |
| Velocity | Note ON Note OFF | × × | × × | |
| After Touch | Key's Channel's | × × | × × | |
| Pitch Bend | | × | × | |
| Control Change | | × | × | |
| Program Change : | True # ***** | × ***** | × × | |
| System Exclusive | | ○ (rem. 1) | ○ (rem. 2) | |
| System : Clock Real Time : Commands | | ○ ○ (rem. 3) | ○ × | |
| Aux. Mes- sag | : Local ON/OFF : All Notes OFF : Active Sense : Reset | × × × × | × × × × | |
| Notes | rem. 1: MMC (Device ID=00 ~ 99, 127), MTC, Identity reply, FOSTEX Exclusive rem. 2: MMC (Device ID=00 ~ 99, 127), MTC, Inquiry, FOSTEX Exclusive rem. 3: START, STOP, CONTINUE | | | |

Mode 1: OMNI ON, POLY
Mode 3: OMNI OFF, POLY

Mode 2: OMNI ON, MONO
Mode 4: OMNI OFF, MONO

○ : Yes
× : No

MMC Command List

| ● Command List | Movement (Recorder) |
|-------------------|--|
| 01: STOP | STOP |
| 02: PLAY | PLAY |
| 03: DEFERRED PLAY | DEFERRED PLAY |
| 04: FAST FORWARD | F FWD |
| 05: REWIND | REWIND |
| 06: RECORD STROBE | REC |
| 07: RECORD EXIT | PUNCH OUT |
| 09: PAUSE | STOP |
| 40: WRITE | Refer to MMC Response/Information Field List |
| 41: MASKED WRITE | Refer to MMC Response/Information Field List |
| 42: READ | Refer to MMC Response/Information Field List |
| 44: LOCATE | LOCATE to Setting Data |
| 46: SEARCH | CUE/REVIEW ($\pm 1 \sim 60$ times) |
| 47: SHUTTLE | CUE/REVIEW ($\pm 1 \sim 60$ times) |
| 4C: MOVE | Refer to MMC Response/Information Field List |
| 4D: ADD | Refer to MMC Response/Information Field List |
| 4E: SUBTRACT | Refer to MMC Response/Information Field List |

| ● MMC Response/Information Field List | Command |
|---------------------------------------|------------------------------|
| 01: SELECTED TIME CODE | READ/WRITE/MOVE/ADD/SUBTRACT |
| 03: REQUESTED OFFSET | READ/WRITE |
| 04: ACTUAL OFFSET | READ |
| 08: GP0 | READ/WRITE/MOVE/ADD/SUBTRACT |
| 09: GP1 | READ/WRITE/MOVE/ADD/SUBTRACT |
| 0A: GP2 | READ/WRITE/MOVE/ADD/SUBTRACT |
| 0B: GP3 | READ/WRITE/MOVE/ADD/SUBTRACT |
| 0C: GP4 | READ/WRITE/MOVE/ADD/SUBTRACT |
| 0D: GP5 | READ/WRITE/MOVE/ADD/SUBTRACT |
| 0E: GP6 | READ/WRITE/MOVE/ADD/SUBTRACT |
| 0F: GP7 | READ/WRITE/MOVE/ADD/SUBTRACT |
| 48: MOTION CONTROL TALLY | READ |
| 4C: RECORD MODE | READ/WRITE |
| 4E: TRACK RECORD STATUS | READ |
| 4F: TRACK RECORD READY | READ/WRITE/MASKED WRITE |
| 51: RECORD MONITOR | READ/WRITE |

Inquiry Message List

IDENTITY REQUEST : F0, 7E, <channel>, 06, 01, F7

IDENTITY REPLY : F0, 7E, <channel>, 06, 02, 51, 01, 00, 0C, 00, **, **, **, **, F7

51: Fostex ID

01, 00 : Device family code

0C, 00 : Device family number D-160

**, **, **, **: Software version

Fostex MIDI System Exclusive Message Format for D-160

<Note>

Following protocol is effective only in equipment which will reply by -
 Identity Reply=F0 7E<channel>06 02 51 01 00 0C 00 01 ** ** ** F7 (D-160)
 against the Inquiry Message=F0 7E<channel>06 01.

Fostex System Exclusive Message

General Structure=F0 51<device id><sub id 1>(<data>)F7

* Numbers are all expressed in hexadecimal units.

Table: <sub id 1> (<data>)

| Command or Model Set Controller to D-160 | Acknowledge or Status D-160 to Controller |
|---|--|
| Loop on/off 12 22 (<on/off>) | |
| Post locate 12 28 (<post locate mode>) | |
| Auto rec 12 2D (<on/off>) | 32 2D (<edit message>) |
| Lock enable 12 41 (<lock enable>) | |
| Lock mode 12 42 (<lock mode>) | |
| Copy clip 12 45 (<count><mmc track>) | 32 45 (<edit message>) |
| Copy paste 12 46 (<count=01><repeat count>) or 12 46 (<count><repeat count><mmc track>) | 32 46 (<edit message>) |
| Erase 12 47 (<count><mmc track>) | 32 47 (<edit message>) |
| Clipboard play 12 49 | 32 49 (<edit message><count><mmc track>) |
| Undo 12 4A | 32 4A (<edit message>) |
| Redo 12 4B | 32 4B (<edit message>) |
| Move clip 12 4D (<count><mmc track>) | 32 4D (<edit message>) |
| Move paste 12 4E (<count=01><repeat count>) or 12 4E (<count><repeat count><mmc track>) | 32 4E (<edit message>) |
| Track exchange 12 4F (<channel><channel>) | 32 4F (<edit message>) |
| All erase current PGM 12 50 | 32 50 (<edit message>) |
| Product new PGM 13 3E | 33 3E (<edit message>) |
| Delete current PGM 13 3F | 33 3F (<edit message>) |
| Digital in ch. 13 41 (<channel><channel>) | |
| Adat in 13 41 (<channel=7F><count=0>) or 13 41 (<channel=7F><count><mmc track>) | |
| Digital out ch. 13 42 (<channel><channel>) * Refer to Note. | |
| Adat out 13 42 (<channel=7F><channel=0>) | |
| Program change 13 43 (<program>) | |
| Click on/off 13 44 (<on/off>) | |
| Resolution on/off 13 46 (<on/off>) | |
| Midi Sync out 13 47 (<nidi sync>) | |
| MTC offset mode 13 48 (<MTC offset mode>) | |
| Vari pitch 13 49 (<count=3><on/off><vari data>) or 13 49 (<count=1><on/off>) | |
| Signature set 14 01 (<signature map>) | 34 00 (<edit message>) |
| Tempo set 14 02 (<tempo set map>) | 34 00 (<edit message>) |
| Tempo map all erase 14 03 | 34 00 (<edit message>) |
| Preroll time set 14 04 (<mmc time>) | |
| Frame rate set 14 06 (<frame rate>) | |
| Fs rate set 14 07 (<fs rate>) | |
| Time base set 14 08 (<time base>) | |

Status Request

| Status request command Controller to D-160 | Status reply D-160 to controller |
|---|--|
| Loop op. status 22 21 | 32 21 (<Loop op. mode = 12>) |
| Loop status 22 22 | 32 22 (<on/off>) |
| Post locate status 22 28 | 32 28 (<post locate status>) |
| Auto rec status 22 2D | 32 2D (<edit message>) |
| Lock status 22 41 | 32 41 (<lock status>) |
| Lock mode status 22 42 | 32 42 (<lock mode>) |
| Copy clip status 22 45 | 32 45 (<edit message=01 or =14>) |
| Copy paste status 22 46 | 32 46 (<edit message=02><mmc time>) or 32 46 (<edit message=00>) |
| Erase status 22 47 | 32 47 (<edit message=02><mmc time>) or 32 47 (edit message=00>) |
| Move clip status 22 4D | 32 4D (<edit message=01 or =14>) |
| Move paste status 22 4E | 32 4E (<edit message=02><mmc time>) or 32 4E (<edit message=00>) |
| Digital in ch. st. 23 41 | 33 41 (<channel><channel>) |
| Adat in status 23 41 | 33 41 (<channel=7F><count><mmc track>) |
| Digital out ch. st. 23 42 | 33 42 (<channel><channel>) |
| Adat out status 23 42 | 33 42 (<channel=7F><channel=0>) |
| Program status 23 43 | 33 43 (<program>) |
| Click status 23 44 | 33 44 (<on/off>) |
| Level status 23 45 | 33 45 (<count=10><level data>) |
| resolution status 23 46 | 33 46 (<on/off>) |
| midi sync out status 23 47 | 33 47 (<midi sync>) |
| MTC offset mode status 23 48 | 33 48 (<MTC offset mode>) |
| vari pitch status 23 49 | 33 49 (<count=3><on/off><vari data>) |
| signature map req. 24 01 (<event number>) | 34 01 (<signature map>) |
| tempo set map req. 24 02 (<event number>) | 34 02 (<tempo set map>) |
| preroll time req. 24 04 | 34 04 (<mmc time>) |
| remain time req. 24 05 | 34 05 (<mmc time>) |
| frame rate status 24 06 | 34 06 (<frame rate>) |
| fs rate status 24 07 | 34 07 (<fs rate>) |
| time base status 24 08 | 34 08 (<time base>) |

<Note>

There is a limitation on specifying the <channel><channel> setting. For details, refer to "Explanation on Command/Mode Set" mentioned in later pages.

<Allocation of GP0~GP7>

Edit point memory of this equipment is allotted to the response/information field of 08~0F (GP0~GP7) as shown below.

GP7 however, will be used as the work memory for small adjusting of the registered figure (Refer to Examples 4 and 5).

<Response/Information Field>

| | |
|-------------------------------|--------------------------------|
| 08 GP0 : locate memory | 09 GP1 : clipboard in memory |
| 0A GP2 : clipboard out memory | 0B GP3 : start memory |
| 0C GP4 : auto punch in memory | 0D GP5 : auto punch out memory |
| 0E GP6 : end memory | 0F GP7 : work memory |

[Example 1] <mmc time> is registered in the start memory (using the write command).

F0 7F <device ID> 06 <write = 40> <count> <GP3 = 0B> <mmc time> F7

[Example 2] Locate memory is recalled (using the read command).

F0 7F <device ID> 06 <read = 42> <count> <GP3 = 08> <mmc time> F7

[Example 3] On-the-fly registering in the punch in memory (using the move command).

F0 7F <device ID> 06 <move = 4C> <count> <destination = 0C (GP4) > <source = selected time code = 01> F7

[Example 4] When + 1 frame is to be set in the punch in memory (using the add command).

* Time figure to be added is pre-registered in GP7 (Set 00h 00m 00s 01f in GP7).

F0 7F <device ID> 06 <add = 4D> <count> <destination = 0C (GP4)> <source #1 = 01 (GP4)> <source #2 = 0F (GP7)> F7

[Example 5] When -1 frame is to be set in the punch in memory (using the subtract command).

* Time figure to be subtracted is pre-registered in GP7 (Set 00h 00m 00s 01f in GP7).

F0 7F <device ID> 06 <subtract = 4E> <count> <destination = 0C (GP4)> <source#1 = 0C (GP4)> <source #2 = 0F (GP7)>F7

Data Type

| | |
|---------------------------------|---|
| <loop op.mode> | 12=stop Indicates the next operating mode following locating to the start point (GP1) upon arriving at the end point (GP6) by the play mode. In D-160, 12=stop only is effective. |
| <post locate mode> | 12=stop 15=play Specifies operating mode in which D-160 should enter upon completing the locate operation. Corresponds to the setting of AUTO PLAY ON ("15")/OFF ("12") on the main unit. |
| <count> | 01~7F Specifies succeeding data byte numbers. |
| <mmc track> | Complies to the MMC (MIDI MACHINE CONTROL) standard track bit map. In D-160, you always need to specify three byte combinations of "r0", "r1" and "r2." |
| <edit message> | 00 = no message 01 = completed (completion flag) 02 = active (execution flag) 02<mmc time> = Indicates unprocessed time by active (execution flag) and <mmc time>. 02<count><mmc track> = Indicates source track by active (execution flag) and <mmc track>. Used for clipboard play. 03 = cancel (execution stop) 05 = Indicates rehearsal (rehearsal mode of auto rec). Possible of undo. 06 = Indicates take (take mode of auto rec). Possible of undo. 10 = over value error 10 <mmc time> = Capacity shortage time is indicated by over value error (error by capacity shortage) and <mmc time>. In copy paste, it indicates capacity shortage time required for a minimum one time paste. 11 = Indicates in point error (incorrect in point). 12 = Indicates out point error (incorrect out point). 14 = Indicates void data (data necessary for paste does not exist). 18 = Indicates track select error (track necessary to execute copy/move or erase/cut is not correctly setup). 19<repeat count> = Indicates repeat number error and repeat numbers executable by <repeat count>. 1A = Indicates disable rec (record disable mode). 71 = Indicates on. 72 = Indicates off. |
| <mmc time> | hr mn sc fr {ff/st} complies to the MMC standard time code. |
| <on/off> | 70 = default 71 = on 72 = off |
| <repeat count> | 01~7F Especially when executing commands such as paste, the number of pasting times to be continuously repeated following the auto punch in point is specified. |
| <channel> | 1~18, 7F Select recorder tracks 1~18. "00" in particular, is not specified (default setting). "7F" indicates input/output of Adat optical. For details, refer to explanation on setting the Command/Mode. |
| <lock enable> | 00 = lock disable, chase disable 01 = lock enable, chase enable Corresponds to SLAVE ON ("01")/OFF ("00") in the main unit. |
| <lock status> | 00 = lock disable, chase disable 01 = lock enable (unlocked), chase enable (unlocked) 11 = lock enable (locked), chase enable (locked) |
| <program> | 01~63H Indicates program numbers (P1~P99) on the main unit. However, D-160 can specify only 01 (corresponds to P1)~63H (corresponds to P99). |
| <lock mode> | 40 = Free 42 = Vari 45 = SP DIF 46 = adat Indicates the slave mode when this equipment is set to slave ON. |

| | |
|--------------------------------|---|
| <signature map> | <p>bar2, bar1, bar0, sign, sigd bar2: The 100th digit of the bar figure is expressed in BCD. bar1: The 10th digit of the bar figure is expressed in BCD. bar0: The 1 digit of the bar figure is expressed in BCD. sign: Numerator of the signature to be set is expressed in BCD. sigd: Denominator of the signature to be set is expressed in BCD. When specified as sign=00 and sigd=00, signature data of that bar position will be deleted. Also, bar2=bar1=bar0=sign=sigd=00 indicates "no corresponding data" (such as when a figure specified by <event number> do not exist at receiving the signature map request).</p> |
| <tempo set map> | <p>bar2, bar1, bar0, beat, tmp2, tmp1, tmp0 bar2: The 100th digit of the bar figure is expressed in BCD. bar1: The 10th digit of the bar figure is expressed in BCD. bar0: The 1 digit of the bar figure is expressed in BCD. beat: The beat figure is expressed in BCD. tmp2: Numerator of the tempo to be set is expressed in BCD. tmp1: Denominator of the tempo to be set is expressed in BCD. tmp0: The 1 digit of the tempo is expressed in BCD. When specified as tmp2=tmp1=tmp0=00, tempo data of that bar and meter position will be deleted. Also, bar2=bar1=bar0=sign=sigd=00 indicates "no corresponding data" (such as when a figure specified by <event number> do not exist at receiving the signature map request).</p> |
| <event number> | <p>When one data registered by <signature map> and <tempo set map> is declared as one event, the number of events from head of the tune (the umpteenth event counted from head of the tune) must be specified. <event number="00"> is the first event.</p> |
| <midi sync> | <p>00: Off 01: CLK (MIDI CLOCK) 02: MTC This corresponds to "Midi Sync Out?" of the SETUP menu.</p> |
| <vari data> | <p>Will be composed of two bytes (Q, P). Q: 0qqqqqqq (binary) -> <vari data> = "qqqqqqpppppp" A 14 bit data of X0.1 P: 0qqqqqqq (binary) attached with a minus symbol. Vari-pitch must be specified, at +0.1% when MSB (q)=0 (Example: 0000000000001), and at -0.1% when MSB (q)=1 (Example: 1111111111111).</p> |
| <frame rate> | <p>00: 30nd 01: 29.97nd 02: 29.97df 03: 25 04: 24 05: 30df Corresponds to selecting "Frame Rate?" of the SETUP menu.</p> |
| <fs rate> | <p>00: 48kHz 01: 44.1kHz Corresponds to selecting "Sample Rate?" of the SETUP menu.</p> |
| <MTC offset mode> | <p>00: ABS 01: Signature Corresponds to selecting "MTC Offset Mode?" of the SETUP menu.</p> |
| <time base> | <p>00: ABS 01: BAR BEAT 02: MTC</p> |
| <level data> | <p>t1, t2 tn n: Indicates the track number. tn: Indicates absolute 8 bits of the Audio 16 bit data.</p> |

Explanation on the Command/Mode Set

12 22 (<on/off>): loop on/off command

The command for setting the "loop mode on/off" (=ON/OFF of AUTO RTN) of D-160. Default figure of the loop operation mode is "12=stop" and this cannot be changed.

12 28 (<post locate mode>): post locate command

The command for setting the "post locate mode" (=ON/OFF of AUTO PLAY) of D-160. It will stop after locating if "post locate mode=12." It will enter play after locating if "post locate mode=15."

12 2D (<on/off>): auto rec command

The command for setting "auto rec mode on/off" (=ON/OFF of AUTO PUNCH) of D-160. Upon receiving this command, D-160 will immediately reply the operating condition by sending "32 2D (<edit message>").

12 41 (<lock enable>): lock enable command

The command for setting "slave mode on/off" (setup menu) of D-160.

12 42 (<lock mode>): lock mode command

The command for setup of the slave mode (setup menu) when this equipment is set to "slave mode on."

12 45 (<count><mmc track>) : copy clip command

When this command is received, D-160 will copy (multiple number of tracks can be copied simultaneously) the sound data, as data for copy paste, from the pre-registered clipboard-in point to the clipboard-out point in the track specified by <mmc track>. With completion of copying the data into the clipboard, D-160 will immediately reply with "32 45 (<edit message=01 (completed)>").

If copy cannot be executed due to improper figures of the pre-registered clipboard in/clipboard out points or incorrect track section, the corresponding <edit message> will be returned.

12 46 (<count=01><repeat count>): copy paste command

12 46 (<count><repeat count><mmc track>): copy paste command

When this command is received, D-160 will paste the sound data which has been copied into the clipboard, on the same track from the pre-registered auto punch in point as the starting point for the number of time specified by <repeat count>.

However, if the sound data length in the clipboard is less than 10ms, the specifying the <repeat count> will be limited to "01."

Also, by specifying <mmc track>, paste can be executed on other tracks in mono (in one track units) or stereo units (in combinations of tracks 1&2, 3&4, 5&6.....15 & 16).

Since time corresponding to length of the copy clipped sound data is required to complete the copy paste operation, D-160 immediately replies with "32 46(<edit message=02 (active)>)" after receiving the command.

Successively upon completing the paste operation, "32 46 (<edit message=01 (completed)>)" is transmitted.

If paste cannot be executed due to improper figures of the pre-registered auto punch in point, insufficient disc capacity, no sound data in the clipboard, etc., the corresponding <editmessage> will be replied.

12 47 (<count><mmc track>): erase command

When this command is received, D-160 will erase the data (writes in "0" data) in the section from the pre-registered auto punch in point through auto punch out point in the track specified by <mmc track>. Since time corresponding to length of the erase section is required to complete the erase operation, D-160 will immediately reply by "32 47

(<edit message=02 (active)>)" after receiving the command.

After the completion of erase operation, "32 47 (<edit message=01 (completed)>)" will be transmitted.

If erase cannot be executed due to improper figures of the pre-registered auto punch in point/auto punch out point, incorrect track section, etc., the corresponding <edit message> will be replied.

12 49: clipboard play command

When this command is received, D-160 will playback once from the head of the sound data copied in the clipboard by the copy clip and move clip commands.

Immediately after receiving the command, D-160 will reply with "32 49 (<edit message=02 (active)><count><mmc track>)." The sound data track number is indicated by (mmc track).

Upon completion of playback, "32 49 (<edit message=01 (completed) is sent and clipboard play is ended. If there is no sound data in the clipboard, "32 49 (<edit message=14 (void data)>)" will be sent and clipboard play operation will be interrupted.

12 4A: undo command

Upon receiving this command, D-160 will revert to the condition prior to editing copy paste,erase, move paste, cut, redo operation. With completion of undo operation, D-160 will reply with "32 4A (<edit message=01(completed)>)."

If D-160 is not possible to undo, "32 4A (<edit message=00 (no message)>)" will be replied.

12 4B: redo command

When this command is received, D-160 will return to the condition prior to undo operation.

With completion of redo operation, D-160 will reply with "32 4B (<edit message=01 (completed)>)."

If D-160 is not possible to redo, "32 4B (<edit message=00 (no message)>)" will be replied.

12 4D (<count><mmc track>): move clip command

When this command is received, D-160 will copy (multiple tracks can be copied simultaneously) the sound data from the pre-registered clipboard in point to the clipboard out point, as data for move paste operation.

With completion copying the data into the clipboard, D-160 will immediately reply with "32 4D (<edit message=01 (completed)>)."

If copy cannot be executed by the reason of pre-registered improper clipboard in/clipboard out point figures or incorrect track section, etc., the corresponding <edit message> will be replied.

12 4E (<count=01><repeat count>): move paste command

12 4E (<count><repeat count><mmc track>): move paste command

When this command is received, D-160 will paste the sound data which have been move clipped in the clipboard, for the number of times specified by <repeat count> on the same track from the pre-registered auto punch in point as the starting point.

At the same time, the move clipped original sound data will be erased (data "0" is written in). However, when sound data length in the clipboard is less than 10ms, specifying the <repeat count> will be limited to "01."

Also, by specifying the <mmc track>, paste operation can be executed on other tracks in mono (one track unit) or stereo units (tracks 1&2, 3&4, 5&6..... 15&16).

Since time corresponding to length of the move clipped sound data is required to complete the move paste operation, D-160 will immediately reply with "32 4E (<edit message=02 (active)>)" after receiving the command.

Following completion of the move paste operation, "32 4E (<edit message = 01 (completed)>)" will be sent.

If paste cannot be executed due to improper figures of the previously registered auto punch in point, insufficient disc capacity, no sound data is in the clipboard, etc., the corresponding <edit message> will be replied.

12 4F (<channel><channel>): track exchange command (Exclusive command for FDMS-3.)

When the D-160 receives this command, the track can be exchange between the specified <channel><channel>. Especially, if the first <channel=0>, then exchange by grouping will be executed between channel 1-8 and channel 17-24, and if the next byte <channel=0>, then the exchange will be between channel 9-16 and channel 17-24.

If it cannot be executed for some reason, an error message will be sent back.

12 50: all erase current program command (Exclusive command for FDMS-3.)

When the D-160 receives this command, all audio of the current program will be erased to return it to the initial state of compiling a new program.

As execution of all erase is completed in a comparatively short time, the D-160 will reply with "32 50 (<edit message=01 (completed)>)" immediately after completion of exchange. If it cannot be executed for some reason, an error message will be sent back.

13 3E: product new program command (Exclusive command for FDMS-3.)

When the D-160 receives this command, a new program is compiled and the current program is transferred to the new program.

As compilation of the new program is comparatively short time, it is replied with "33 3E (<edit message=01 (completed)>)" immediately upon completion of execution. If it cannot be executed for some reason, an error message will be sent back.

13 3F: delete current program command (Exclusive command for FDMS-3.)

When the D-160 receives this command, the current program is deleted and succeeding programs moved up and renumbered. If the deleted program is the only tune existing in the track, a new program will be made automatically.

As this delete current program is executed in a comparatively short time, "33 3F (<edit message=01 (completed)>)" will be sent back immediately upon completing the execution. If it cannot be executed for some reason, an error message will be sent back.

13 41 (<channel><channel>): digital in ch.select command

The audio signal input from SPDIF digital in to assigned to the destination track specified by <channel>. The first <channel> shown in the command is the SPDIF L channel input, and the second <channel> the R channel input. "<channel=0> <channel =0>" indicates the normal analog input.

13 41 (<channel=7F><count><mmc track>): Adat in select command

Channel = 7F indicates that it is Adat In.

Normally, it will be "<count=0>" and all channels will be inputs from Adat In.

If <count≠0><mmc track> is indicates, then only the tracks selected will be Adat In inputs. "<channel=0><channel=0>" indicates the normal analog input.

13 42 (<channel><channel>): digital out ch.select command

The source channel for digital out is selected.

Normally, the first <channel> shown will be the SPDIF L channel data, and the second <channel> the SPDIF R channel output.

By FDMS-2 (D-80, DMT-8) in particular, the following five types only can be setup. (<01><02>), (<03><04>), (<05><06>), (<07><08>), (<00><00>). (<00><00>) is the default setting. By FDMS-3 (D-160), any channel within "1 ~ 16" can be selected.

13 42 (<channel=7F><channel=0>): Adat out select command

In a device which can be switched between SPDIF and Adat, if the first display is <channel=7F>, then Adat Out can be setup.

13 43(<program>): program change command

The command for PROGRAM CHANGE of D-160. The present program number can be changed to the figure indicated by <program>.

13 44 (<on/off>): click on/off command

The command for setting the metronome on/off of D-160. When ON is set, the metronome signal will be fed to the track 16 output (analog output only) of D-160.

13 46 (<on/off>): Bar/Beat Resolution ON/OFF command

The command for ON/OFF of the bar/beat resolution function of this equipments' current program.

13 47 (<midi sync>): Midi Sync Out command

The setup command for MIDI Sync Out mode of this equipments' current program.

13 48 (<MTC offset mode>): MTC offset mode command

The setup command for MTC offset mode of this equipments' current program.

13 49 (<count=3> <on/off> <vari data>): Vari pitch command

13 49 (<count=1> <on/off>): Vari pitch command

The command for setting this equipments' vari pitch ON/OFF and pitch data. Control of ON/OFF only is possible at <count=1> and both ON/OFF and pitch data can be set at <count=3>.

14 01 (<signature map>): Signature set command

The command for setting the meter of this equipment. If a new data is registered at the bar position where a data exists, the former data will be written over. When this command is received, this equipment will reply with "34 00 (<edit message>)." Upon completing the registration, <edit message> will reply with "01 (completed)," or with "10 (over value error)" if registration is attempted at a non-existing point or an erroneous figure is used.

14 02 (<tempo set map>): Tempo set command

The command for tempo set of this equipment. If a new data is registered in a bar/meter where data already exists, the former data will be written over. When this command is received, this equipment will reply with "34 00 (<edit message>)." Upon completing the registration, <edit message> will reply with "01 (completed)," or with "10 (over value error)" if registration is attempted at a non-existing point or an erroneous figure is used.

14 03 : Tempo map all erase command

When this command is received, this equipment will erase all meter and tempo data in the current program and thus return it to the default state (meter=4/4, tempo: =120). Also, when this command is received, this equipment will reply with "34 00 (<edit message>)." Upon completing the registration, <edit message> will reply with "01 (completed)," or with "10 (over value error)" if registration is attempted at a non-existing point or an erroneous figure is used.

14 04 (<mmc time>): Preroll time set command

The command for setting the current program preroll time at the figure indicated by <mmc time>.

14 06 (<frame rate>): Frame rate set command

The command for setting the current program frame rate at the figure indicated by <frame rate>.

14 07 (<fs rate>): Fs rate set command

The command for setting the current program fs (sampling frequency) at the figure indicated by <fs rate>.

14 08 (<time base>): Time base set command

The command for setting the current program time base of this equipment to that indicated by <time base>.

The Status Request Command

22 21: loop operation status request

The command inquiring the loop operation mode setup status.
D-160 will reply with "32 21 (<loop op.mode=12>)."

22 22: loop on/off status request

The command inquiring the loop on/off (=ON/OFF of AUTO RETURN) setup status.
D-160 will reply with "32 22 (<on/off>)."

22 28: post locate status request

The command inquiring the post locate mode (ON/OFF of AUTO PLAY) setup status.
D-160 will reply with "32 28 (<post locate mode>)."

22 2D: auto rec status request

The command inquiring the auto rec mode setup status and this is replied by "32 2D (<edit message>)." Reply from D-160 against this status request will be either one of the following:

<edit message> =05: Possible to undo rehearsal mode.
=06: Possible to undo take mode.
=72: off

22 41: lock status request

The command inquiring the slave on/off setup status and the lock status.
D-160 will reply with "32 41 (<lock status>)."

22 42 : lock mode status request

The command for inquiring the lock mode setup status and this is replied with "32 42 <lock mode>."

22 45: copy clip status request

The command inquiring the clipboard condition. If there is a copy paste data in the clipboard, D-160 will reply with "32 45 (<edit message=01>)." If data in the clipboard is for move paste or there is no valid data in it, it will reply will "32 45 (<edit message=14 (void data)>)."

22 46: copy paste status request

The command inquiring execution status of copy paste editing.
When this command is received, D-160 will reply with either "32 46 (<edit message=02> <mmc time>)" or "32 46 (<edit message=00>)." <mmc time> indicates unprocessed time until completion.

22 47: erase status request

The command inquiring execution status of erase.
When this command is received, D-160 will reply by either "32 47 (<edit message=02> <mmc time>)" or "32 47 (<edit message=00>)." <mmc time> indicates unprocessed time until completion.

22 4D: move clip status request

The command inquiring the clipboard status. If there is a move paste data on the clipboard, D-160 will reply with "32 4D (<edit message=01>)." If data in the clipboard is for copy paste or there is no valid data on it, "32 4D (<edit message=14 (void data)>)" will be replied.

22 4E: move paste status request

The command inquiring the move paste execution status.

When this command is received, D-160 will reply with "32 4E (<edit message=02><mmc time>)" or "32 4E (<edit message=00>)." <mmc time> indicates unprocessed time until completion.

23 41: digital in channel status request

23 41: adat in channel status request

The command inquiring the digital in channel setup status.

When this command is received, D-160 will reply with "33 41 (<channel><channel>)" or "33 41 (<channel=7F><count><mmc track>)."

23 42: digital out channel status request

23 42: adat out channel status request

The inquiring the digital out channel setup status.

When this command is received, D-160 will reply with "33 42 (<channel><channel>)" or "33 42 (<channel=7F><channel=0>)."

23 43: program status request

The command inquiring the presently operating program number.

When this command is received, D-160 will reply with "33 43 (<program>)."

23 44: click on/off status request

The command inquiring the metronome on/off status of D-160.

When this command is received, D-160 will reply with "33 44 (<on/off>)."

23 45: level status request

The command inquiring the present output level data of the 1~16 tracks. In D-160 as the level data is updated about every 40msec., inquiry in 40msec. units is effective.

When this command is received, D-160 will reply with "33 45 (<count=10><level data>)."

23 46: resolution status request

The command for inquiring the resolution on/off setup status.

When this command is received, this equipment replies with "33 46 <on/off>."

23 47: midi sync out status request

The command for inquiring on status of the midi sync out setup condition.

When this command is received, this equipment replies with "33 47 <midi sync>."

23 48: MTC offset mode status request

The command for inquiring the MTC offset mode setup status. When this command is received, this equipment replies with "33 48 <MTC offset mode>."

23 49: vari pitch status request

The command for inquiring status of vari pitch on/off and vari pitch data. When this command is received, this equipment replies with "33 49 (<count=3> <on/off> <vari data>)."

24 01 (<event number>): signature map request

The command for inquiring the meter setup. Order number counting from the leading tune must be specified in the event number (The first event is expressed as "event number=00." When this command is received, this equipment replies with "34 01 (<signature map>)."

24 02 (<event number>): Tempo set map request

The command for inquiring tempo data. Order number from the leading tune must be specified in the event number (The first event is expressed as "event number=00." When this command is received, this equipment replies with "34 02 (<tempo set map>)."

24 04: preroll time status request

The command for inquiring the preroll time setup status.

When this command is received, this equipment replies with "34 04 (<mmc time>)."

24 05: remain time request

The command for inquiring the disk remaining time which is recordable.

When this command is received, this equipment replies with "34 05 (<mmc time>)."

24 06: frame rate status request

The command for inquiring the frame rate setup status.

When this command is received, this equipment replies with "34 06 (<frame rate>)."

24 07: fs rate status request

The command for inquiring the fs (sampling frequency) setup status.

When this command is received, this equipment replies with "34 07 (<fs rate>)."

24 08: time base status

The command for inquiring the setup status of the time base shown in the display.

When this command is received, this equipment replies with "3408 (<time base>)."

Explanation on the Status Reply

32 21 (<loop op.mode>): loop operation mode status reply

This is the reply against the "22 21" loop operation status request command.

<loop op.mode=12> is the only status data of D-160 and any other setting is not permissible.

32 22 (<on/off>): loop on/off status reply

This is the reply against "22 22" loop on/off status request.

32 28 (<post locate mode>): post locate mode status reply

This is the reply against "22 28" post locate status request. <post locate mode=12 or 15> is the only status data of D-160 and any other setting is not permissible.

32 2D (<edit message>): auto rec status reply

This is the reply against the "12 2D" auto rec command or the "22 2D" auto rec status request.

32 41 (<lock status>): lock status reply

This is the reply against the "22 41" lock status request.

32 42 (<lock mode>): lock mode status reply

This the reply against the "22 42" lock mode status request.

32 45 (<edit message>): copy clip status reply

This is the reply against the "12 45" copy clip command or the "22 45" copy clip status request.

32 46 (<edit message>): copy paste status reply

32 46 (<edit message><mmc time>): copy paste status reply

This is the reply against the "12 46" copy paste command or the "22 46" copy paste status request. <mmc time> indicates the unprocessed time until completion of copy paste editing.

32 47 (<edit message>): erase status reply

32 47 (<edit message><mmc time>): erase status reply

This is the reply against "12 47" erase command or "22 47" erase status request.

32 49 (<edit message><count><mmc track>): clipboard play status reply

This is the reply against the "12 49" clipboard play command. If there is no sound data in the clipboard, "32 49"(<edit message=14 (void data)>)" will be replied. <mmc track> indicates the sound data track number.

32 4A (<edit message>): undo status reply

This is the reply against the "12 4A" undo command. Either <edit message=01 (completed) or <edit message=14 (void data)> will be replied.

32 4B (<edit message>): redo status reply

This is the reply against the "12 4B" redo command. Either <edit message=01 (completed)> or <edit message=14 (void data)> will be replied.

32 4D (<edit message>): move clip status reply

This is the reply against the "12 4D" move clip command or "22 4D" move clip status request.

32 4E (<edit message>): move paste status reply

32 4E (<edit message><mmc time>): move paste status reply

The reply against the "12 4E" move paste command or the "22 4E" move paste status request. <mmc time> indicates the unprocessed time until completion of move paste editing.

32 4F (<edit message>): track exchange status reply

This is the reply against the "12 4F" track exchange command.

33 3E (<edit message>): product new program status reply

This is the reply against the "13 3E" product new program command.

33 41 (<channel> <channel>): digital in channel status reply

33 41 (<channel=7F> <count> <mmc track>): adat in status reply

This is the reply against the "23 41" digital in ch. st. request.

The first <channel> indicates the track number assigned to the L channel of the digital audio signal (S/P DIF) from the DATA IN connector, and the second <channel> the track number assigned to the R channel. If digital in is set to "Adat," the reply for the first <channel> will be 7F and then <count> <mmc track>, in this order.

In the <mmc track>, the track bit map which is the Adat input, is expressed by "1" (In this equipment, the reply will all be "1", or in other words, all tracks will be collectively converted to Adat inputs or analog inputs).

33 42 (<channel> <channel>): digital out channel status reply

33 42 (<channel=7F> <channel=00>): adat out status reply

This is the reply against the "23 42" digital out ch. st. request.

The first <channel> indicates the track number assigned to the L channel output of the digital audio signal (S/P DIF) from the DATA OUT connector, and the second <channel> the track number as signed to the R channel output. If digital out is set to "Adat," the reply for the first <channel> will be 7F and that for the second <channel> will be 00.

33 43 (<program>): program status reply

This is the reply against the "23 43" program status request.

<program> indicates the presently operating program number.

33 44 (<on/off>): click status reply

This is the reply against the "23 44" click status request.

It indicates the on/off setting of the metronome function.

33 45 (<count=10><level data>): level status reply

This is the reply against the "23 45" level status request and it indicates the present track 1~16 output level data.

In D-160, as level data is updated 40msec., it will be effective if inquiry is made in 40msec. units.

33 46 (<on/off>): bar/beat resolution status reply

This is the reply against "23 46" bar/beat resolution status request.

33 47 (<midi sync>): midi sync out status reply

This is the reply against "23 47" midi sync out status request.

33 48 (<MTC offset mode>): MTC offset mode status reply

This is the reply against "23 48" MTC offset mode status request.

33 49 (<count=3> <on/off> <vari data>): vari pitch status reply

This is the reply against "23 49" vari pitch status request and is indicating the vari pitch function on/off and the present vari pitch setup figure.

34 01 (<signature map>): signature map status reply

This is the reply against "24 01" (<event number>) signature map request.

The signature map of the event indicated by the <event number> is replied.

If there is no event specified (Example: Such as when <event number=5> is requested even though there is only 5 meters registered), it will be replied with all figures at 00 of the <signature map>.

34 02 (<tempo set map>): tempo set map status reply

The reply against "24 02"(<event number>)tempo set map request.

Tempo set map of the event indicated by the <event number> is replied.

If there is no event specified (Example: Such as when <event number=20> is requested although only 10 is setup for tempo), it will be replied with all figures at 00 of the <signature map>.

34 04 (<mmc time>): preroll set map status reply

This is the reply against "34 04" preroll time status request and this is replied with the presently set preroll time.

34 05 (<mmc time>): remain time reply

This is the reply against "24 05" remain time request, and is replied with the recordable disc remaining time.

34 06 (<frame rate>): frame rate status reply

This is the reply against "24 06" frame rate status request, and is replied with the presently set frame rate.

34 07 (<fs rate>): fs rate status reply

This is the reply against "24 07" fs rate status request, and is replied with the presently set fs (sampling frequency).

34 08 (<time base>): time base status reply

This is the reply against "24 08" time base status request, and is replied with the presently set time base (in the display).

Maintenance

Cleaning the exterior

*** For normal cleaning, use a soft dry cloth.**

For stubborn dirt, moisten a cloth in diluted detergent, wring it out firmly, and wipe the dirt off. Then polish with a dry cloth.

Never use solvents such as alcohol, thinner or benzene, since these will damage the printing and finish of the exterior.

Specifications

Input/Output

INPUT (1 ~ 8)

Connector : RCA pin jack (X 8)
 Input impedance : 10k Ω or more
 Input level : -10dBV

OUTPUT (1 ~ 16)

Connector : RCA pin jack (X 16)
 Load impedance : 10k Ω or more
 Output level : -10dBV

DATA IN/OUT

Connector : Optical (X 4)
 Format : (1) IEC 958 Part 2 (=S/P DIF)
 : (2) Alesis Proprietary Multi Channel Optical Interface
 (Either (1) or (2) is selected in the Setup mode.)

MIDI IN/OUT/THRU

Connector : DIN 5PIN (X 3)
 Format : MIDI standard

SCSI

Connector : D-sub 25 pin (X1)

PUNCH IN/OUT

Connector : ϕ 6mm Phone jack (X 1)
 (An optional FOOT SW Model 8051 can be connected.)

REMOTE

Connector : D-sub 15PIN (X 1)

Recording/Reproducing

Recording medium : 3.5 inch, hard disk x 1 (E-IDE type),
 (Optional hard disk)

Recording format : FDMS-3*

Save/Load format : FDIO-1 Ver.2**

Sampling frequency : 44.1kHz/48kHz

Quantization : 16-bit linear (Non expanded)
 A/D: 18-bit 64-time, over sampling, Delta-Sigma
 D/A: 20-bit 128-time, over sampling, Delta-Sigma

| | |
|------------------------------------|---|
| Recording time | : approx. 240 minutes (at Optional Model 9041/ 44.1kHz/Mono track recording) |
| No. of recording track | : 16 + 8 Additional tracks |
| Program No. | : maximum 99 tunes |
| Crossfade | : 10msec. |
| Recording/reproducing frequency | : 20Hz ~ 20kHz |
| Dynamic range | : 90dB |

General

| | |
|-------------------|--|
| Dimensions | : 482 (W) X 140.5 (H) X 381 (D) mm, 3U size * Including highest protrusion. |
| Weight | : approx. 8.0kg (with REMOTE controller) |
| Power supply | : 120VAC 60Hz : 230V~ 50/60Hz |
| Power consumption | : approx. 32W |

* Specifications and appearance are subject to change without notice for product improvement.

* "Adat" and the  symbol are trademarks of Alesis Corporation.

* FDMS-3: Fostex Disk Management System-3.

* FDIO-1 Ver.2: Fostex Data In Out-1 Ver.2

INDEX

- [A]**
- About copy rights 8
 - About damages 8
 - Auto play/Auto return key 15
 - Auto punch mode ON/OFF key 20
 - Auto punch in key 16
 - Auto punch out key 16
 - Auto return start key 15
 - Auto return end key 16
 - ABS time display 26
 - ABS 32, 38
 - Audio file 33
 - Additional track 36
 - Analog recording 53
 - Auto play mode 70
 - Auto return mode 70
 - Auto repeat mode 74
 - Auto punch in/out 76
- [B]**
- Basic connections 46
 - Backup 111
- [C]**
- Clipboard in key 15
 - Clipboard out key 15
 - Copy key 20
 - Connecting a digital mixer 65
 - Changing the stored the start/end point 73
 - Copy and Pasting 88
 - Copying 86
 - Copy and paste undo/redo 90
 - compatibility with D-90, D-80 ver2 etc. 116
- [D]**
- Display section 25
 - Dust cap 8, 39
 - DISK REMAIN display 26
 - Disk Error ! display 30
 - Disable REC ! display 30
 - Disconnect SCSI display 31
 - Default setting on the D-160 48
 - Deleting program 51
 - Digital recording 60
 - Display select key 17
 - DATA IN connector 23
 - DATA OUT connector 24
- [E]**
- Erase key 19
 - Execute/Yes key 17
 - Exit/No key 17
 - Event Over ! display 30
 - Error 35 display 31
 - Error 36 display 31
 - Event 33
 - Extention cable 44
 - Editing and storing the start/end point 72
 - Erasing 96, 99, 101
 - Entering Setup mode 137
- [F]**
- Fast forward button 22
 - Formatting the hard disk 39, 43, 171
 - Formatting a SCSI disk 109
 - Frame rate setting 151
- [H]**
- Hold/Digit move key 18
 - Hard disk operation LED 13, 23
 - Hard disk recording 32
 - Hard disk 39
- [I]**
- Introduction 6
 - Input jack 23
 - Input monitor 37
 - Installing a hard disk 39
 - Inquiry message list 173
- [J]**
- Jog dial 18
- [L]**
- Locate key 21
 - Load Error ! display 30
 - Lock/unlock key 40
 - Locate function 67
 - Loading the data 102, 106
- [M]**
- Main features 9
 - Meter display 25
 - MIDI IN connector 24
 - MIDI OUT connector 24
 - MIDI THRU connector 24
 - MTC display 27
 - MTC 38
 - Mixdown 58
 - Moving 91
 - Move & pasting 93
 - Move & paste undo/redo 95
 - MIDI clock synchronization system 117
 - MTC synchronization system 120
 - Multitrack system by the slave mode 123
 - Multitrack system using a DMT-8 V2.0 133
 - Metronome function ON/OFF 148
 - MIDI SYNC OUT setting 150
 - MTC frame rate setting 151
 - MTC OFFSET time setting 152
 - MTC OFFSET MODE setting 153
 - MIDI device ID setting 161
 - MIDI implementation chart 172
 - MMC command list 173
 - Maintenance 189

| | | | | |
|-----|--|--------------------|--------------------------------|---------|
| [N] | Notes about power supply | 6 | Slave mode setting | 154 |
| | Notes on handling the hard disk | 7 | Slave mode type setting | 155 |
| | Notes on the setup location | 7 | Sampling Frequency setting | 162 |
| | Notes on repair | 8 | Specifications | 189 |
| | Notes on using detachable controller | 8 | [T] | |
| | No disk IDE display | 31 | Timebase | 38 |
| [O] | | | Track swapping | 142 |
| | Over ! display | 29 | Time signature setting | 143 |
| | Overdubbing | 57 | Tempo setting | 145 |
| [P] | | | [U] | |
| | Precautions | 6 | Undo key | 19 |
| | Paste key | 20 | Un Format ! display | 30 |
| | Play button | 22 | Undo/Redo of Auto Punch In/Out | 80, 84 |
| | Punch in/out jack | 23 | Undo/Redo the paste operation | 90, 95 |
| | Power switch | 13 | Undo/Redo the erase operation | 98, 100 |
| | Power cable | 24 | [V] | |
| | Panel A, B | 24 | Vari pitch key | 19 |
| | Preset display | 25 | Void data ! display | 29 |
| | Program change | 28, 35, 50, 54 | Void In Point ! display | 29 |
| | Ping-pong recording | 59 | Void Out Point ! display | 29 |
| | Punch In/Out | 75 | Vari pitch function | 56 |
| | Punch In/Out recording using a foot switch | 81 | [W] | |
| | Punch In/Out rehearsal mode | 78, 82 | Warning message | 29 |
| | Punch In/Out take mode | 79, 83 | | |
| | Program title setting | 147 | | |
| | Program delete | 147 | | |
| | Preroll time setting | 149 | | |
| [R] | | | | |
| | Record track select key | 14 | | |
| | Redo key | 19 | | |
| | Recall key | 19 | | |
| | Record button | 21 | | |
| | Rewind button | 22 | | |
| | Repro monitor | 37 | | |
| | Real track | 36 | | |
| | REMAIN | 32 | | |
| | Recording/playback | 46 | | |
| | Record protect setting | 156 | | |
| [S] | | | | |
| | Shift key | 15 | | |
| | Store key | 18 | | |
| | Shuttle dial | 18 | | |
| | Stop button | 21 | | |
| | SCSI connector | 24 | | |
| | Switching the time base display | 27 | | |
| | Select Track ! display | 29 | | |
| | Setting a program | 49 | | |
| | Setting a sampling rate | 52, 162 | | |
| | Storing memory data | 67 | | |
| | Setting the auto return start/end point | 71 | | |
| | Storing the punch in/out point | 76 | | |
| | Saving data | 102, 104, 108, 168 | | |
| | Song | 111 | | |
| | Slave mode | 123, 127, 130 | | |
| | SETUP mode | 137 | | |

Declaration of EC Directive

This equipment is compatible with the EMC Directive (89/336/EEC) - Directive on approximation of member nation's ordinance concerning the electromagnetic compatibility and with the Low Voltage Directive (73/23/EEC) - Directive on approximation of member nation's ordinance connecting electric equipment designed to be used within the specified voltage range.

The Affect of Immunity on This Equipment

The affect of the European Specification EN50082-1 (coexistence of electromagnetic waves - common immunity specification) on this equipment are as shown below.

** In the electrical fast transient/burst requirements, radiate electromagnetic field requirements and static electricity discharging environment, this could be affected by generation of noise in some cases. The display content could also differ from actual figures.*

Please comply to the precautions below to make this equipment compatible with European Specification EN50082-1 (coexistence of electromagnetic waves - common immunity specification).

<NOTE>

Caps are installed on the rear panel MIDI IN/OUT/THRU and SCSI connectors. The purpose of these caps are to prevent static electricity from affecting this equipment. Do not remove these caps except when using the MIDI IN/OUT/THRU and SCSI connectors.

FOSTEX DISTRIBUTORS LIST IN EUROPE

* Including non-EU countries.

* underlined: contracted distributors (as of May, 1997)

<AUSTRIA>

NAME: ATEC Audio-u. Videogeraete VertriebsgesmbH.
ADD: Im Winkel 5, A-2325 Velm, Austria
TEL: (+43) 2234-74004, FAX: (+43) 2234-74074

<BELGIUM>

NAME: EML N. V.
ADD: Bijvennestraat 1A, B3500 Hasselt, Belgium
TEL: (+32) 11-232355, FAX: (+32) 11-232172

<DENMARK>

NAME: SC Sound ApS
ADD: Malervej 2, DK-2630 Taastrup, Denmark
TEL: (+45) 4399-8877, FAX: (+45) 4399-8077

<FINLAND>

NAME: Noretron Audio
ADD: Tonttumuorinkuja 4, FIN-02200 Espoo, Finland
TEL: (+358) 0-5259330, FAX: (+358) 0-52593352

<FRANCE>

NAME: Musikengro
ADD: ZAC de Follieuses, B. P. 609, 01706 Les Echets, France
TEL: (+33) 72 26 27 00, FAX: (+33) 72 26 27 01

<GERMANY>

NAME: Studiosound & Music GmbH
ADD: Scheppe Gewissegasse 8, D-35039 Marburg, Germany
TEL: (+49) 6421-12071, FAX: (+49) 6421-15522

<GREECE>

NAME: Bon Studio S. A.
ADD: 6 Zaimi Street, Exarchia, 106.83 Athens, Greece
TEL: (+30) 1-3809605-8, 3302059
FAX: (+30) 1-3845755

<ICELAND>

NAME: I. D. elrf. electronic Ltd.
ADD: ARMULA38 108 REYKJAVIK ICELAND
TEL: (+354) 588 5010, FAX: (+354) 588 5011

<ITALY>

NAME: Recoton Italia Srl.
ADD: V. 1 Maggio, N 18, 40050 Quarto Inferiore, (BO) Italy
TEL: (+39) 51-768576, FAX: (+39) 51-768336

<THE NETHERLANDS>

NAME: IEMKE ROOS AUDIO B. V.
ADD: Kuiperbergweg 20, 1101 AG Amsterdam, The Netherlands
TEL: (+31) 20-697-2121
FAX: (+31) 20-697-4201

<NORWAY>

NAME: Siv. Ing. Benum A/S
ADD: P. O. Box 145 Vinderen, 0319 Oslo 3, Norway
TEL: (+47) 22-139900, FAX: (+47) 22-148259

<PORTUGAL>

NAME: Caius - Tecnologias Audio e Musica, Lda.
ADD: Rua de Santa Catarina, 131 4000 Porto, Portugal
TEL: (+351) 2-2084456/325400
FAX: (+351) 2-314760

<SPAIN>

NAME: Multitracker, S. A.
ADD: C/Garcilaso No.9, Madrid 28010, Spain
TEL: (+34) 1-4470700, 1-4470898
FAX: (+34) 1-5930716

<SWEDEN>

NAME: TTS Tal & Ton Studioteknik AB
ADD: Gelbgjutarevagen 4, S-171 48 Solna, Sweden
TEL: (+46) 8-7340750, FAX: (+46) 8-824476

<SWITZERLAND>

NAME: Audio Bauer Pro AG
ADD: Bernerstrasse-Nord 182, CH-8064 Zurich, Switzerland
TEL: (+41) 1-4323230, FAX: (+41) 1-4326558

<UK>

NAME: SCV London
ADD: 3A 6-24 Southgate Road, London N1 3JJ, England, UK
TEL: (+44) 171-923-1892, FAX: (+44) 171-241-3644

Fostex[®]

FOSTEX CORPORATION

3-2-35 Musashino, Akishima-shi, Tokyo, Japan 196-0021

FOSTEX CORPORATION OF AMERICA

15431, Blackburn Ave., Norwalk, CA 90650, U. S. A.