



8289647000
(480799)



Model UR-2

STEREO RACK MEMORY RECORDER





Owner's Manual

Fostex

	CAUTION RISK OF ELECTRIC SHOCK DO NOT OPEN	
<p>CAUTION: TO REDUCE THE RISK OF ELECTRIC SHOCK, DO NOT REMOVE COVER (OR BACK). NO USER - SERVICEABLE PARTS INSIDE. REFER SERVICING TO QUALIFIED SERVICE PERSONNEL.</p>		

<p>CAUTION: TO PREVENT ELECTRIC SHOCK, MATCH WIDE BLADE OF PLUG TO WIDE SLOT, FULLY INSERT.</p> <p>ATTENTION: POUR ÉVITER LES CHOCS ÉLECTRIQUES, INTRODUIRE LA LAME LA PLUS LARGE DE LA FICHE DANS LA BORNE CORRESPONDANTE DE LA PRISE ET POUSSER JUSQU' AU FOND.</p>

 The lightning flash with arrowhead symbol, within an equilateral triangle, is intended to alert the user to the presence of uninsulated "dangerous voltage" within the product's enclosure that may be of sufficient magnitude to constitute a risk of electric shock to persons.

 The exclamation point within an equilateral triangle is intended to alert the user to the presence of important operating and maintenance (servicing) instructions in the literature accompanying the appliance.

"WARNING"

"TO REDUCE THE RISK OF FIRE OR ELECTRIC SHOCK, DO NOT EXPOSE THIS APPLIANCE TO RAIN OR MOISTURE."

SAFETY INSTRUCTIONS

1. Read Instructions - All the safety and operating instructions should be read before the appliance is operated.
2. Retain Instructions - The safety and operating instructions should be retained for future reference.
3. Heed Warnings - All warnings on the appliance and in the operating instructions should be adhered to.
4. Follow Instructions - All operating and use instructions should be followed.
5. Water and Moisture - The appliance should not be used near water - for example, near a bathtub, washbowl, kitchen sink, laundry tub, in a wet basement, or near a swimming pool, and the like.
6. Carts and Stands - The appliance should be used only with a cart or stand that is recommended by the manufacturer.



An appliance and cart combination should be moved with care. Quick stops, excessive force, and uneven surfaces may cause the appliance and cart combination to overturn.

7. Wall or Ceiling Mounting - The appliance should be mounted to a wall or ceiling only as recommended by the manufacturer.
8. Ventilation - The appliance should be situated so that its location or position does not interfere with its proper ventilation. For example, the appliance should not be situated on a bed, sofa, rug, or similar surface that may block the ventilation openings; or, placed in a built-in installation, such as a bookcase or cabinet that may impede the flow of air through the ventilation openings.
9. Heat - The appliance should be situated away from heat sources such as radiators, heat registers, stoves, or other appliances (including amplifiers) that produce heat.
10. Power Sources - The appliance should be connected to a power supply only of the type described in the operating instructions or as marked on the appliance.
11. Grounding or Polarization - The precautions that should be taken so that the grounding or polarization means of an appliance is not defeated.

12. Power Cord Protection - Power supply cords should be routed so that they are not likely to be walked on or pinched by items placed upon or against them, paying particular attention to cords at plugs, convenience receptacles, and the point where they exit from the appliance.
13. Cleaning - The appliance should be cleaned only as recommended by the manufacturer.
14. Nonuse Periods - The power cord of the appliance should be unplugged from the outlet when left unused for a long period of time.
15. Object and Liquid Entry - Care should be taken so that objects do not fall and liquids are not spilled into the enclosure through openings.
16. Damage Requiring Service - The appliance should be serviced by qualified service personnel when:
 - A. The power supply cord or the plug has been damaged; or
 - B. Objects have fallen, or liquid has been spilled into the appliance; or
 - C. The appliance has been exposed to rain; or
 - D. The appliance does not appear to operate normally or exhibits a marked change in performance; or
 - E. The appliance has been dropped, or the enclosure damaged.
17. Servicing - The user should not attempt to service the appliance beyond that described in the operating instructions. All other servicing should be referred to qualified service personnel.
18. The appliance should be situated away from drops of water or spray of water.
19. Objects containing liquid such as vase must not be put on the appliance.
20. The appliance is not completely isolated from the power supply even if the power switch is at off position.
21. Apparatus shall not be exposed to dripping or splashing and no objects filled with liquids, such as vases, shall be placed on the apparatus.
22. Only use attachments/accessories specified by the manufacturer.
23. An appliance with a protective earth terminal should be connected to a mains outlet with a protective earth connection.
24. An appliance should be placed in a position where an AC plug / inlet can be easily pulled out by hand.
25. Main plug is used as the disconnection device. It shall remain readily operable and should not be obstructed during intended use. To be completely disconnected the apparatus from supply mains, the mains plug of the apparatus shall be disconnected from the mains socket outlet completely.

Important Safety Instructions

- 1) Read these instructions.
- 2) Keep these instructions.
- 3) Heed all warnings.
- 4) Follow all instructions.
- 5) Do not use this apparatus near water.
- 6) Clean only with dry cloth.
- 7) Do not block any ventilation openings. Install in accordance with the manufacturer's instructions.
- 8) Do not install near any heat sources such as radiators, heat registers, stoves, or other apparatus (including amplifiers) that produce heat.
- 9) Do not defeat the safety purpose of the polarized or grounding-type plug. A polarized plug has two blades with one wider than the other. A grounding type plug has two blades and a third grounding prong. The wide blade or the third prong are provided for your safety. If the provided plug does not fit into your outlet, consult an electrician for replacement of the obsolete outlet.
- 10) Protect the power cord from being walked on or pinched particularly at plugs, convenience receptacles, and the point where they exit from the apparatus.
- 11) Only use attachments/accessories specified by the manufacturer.
- 12) Use only with the cart, stand, tripod, bracket, or table specified by the manufacturer, or sold with the apparatus. When a cart is used, use caution when moving the cart/apparatus combination to avoid injury from tip-over.
- 13) Unplug this apparatus during lightning storms or when unused for long periods of time.
- 14) Refer all servicing to qualified service personnel. Servicing is required when the apparatus has been damaged in any way, such as power-supply cord or plug is damaged, liquid has been spilled or objects have fallen into the apparatus, the apparatus has been exposed to rain or moisture, does not operate normally, or has been dropped.



Table of contents

Safety Instructions 2

Introduction

Precaution10

Precautions on installation10

About storage devices11

Formatting of a storage device11

About version upgrade11

Notes on moisture condensation11

Overview

Main features12

Names and functions

Front panel13

Rear panel16

Screen details17

 Home screen in stop or playback mode17

 Home screen in record or input monitor mode18

 Screens in MENU mode19

 Other screens20

Preparation

Connection to external devices (from the front panel)21

 Connection to headphones21

 Connection to a computer21

 Connection to a USB keyboard21

 Connection to an external microphone21

Connection to external devices (from the rear panel)22

 Analog audio connection22

 Digital audio connection22

Foot switch connection	22
Power connection	22
RS232C connection	22
Parallel remote connection	22
Turning on the power	23
Setting the internal clock	23
Adjusting the display	24
Adjusting the brightness of the display	24
Inversing the display	24
Enlarging the file name display	25
Inserting a storage device	26
Removing a storage device	27
Selecting a storage device	28
Basic knowledge about folders and files on a storage device	29

Recording

Recording system	29
Recording time	29
Setup before you start recording	29
SYSTEM SETUP menu item	30
Default file name	30
Recording source	30
Sampling frequency/Quantization bit	30
Recording channels	30
Maximum file size	30
Peak hold time	30
Reference level	30
MIC IN SETUP menu item	31
Enabling/disabling the [MIC IN] key	31
[MIC IN] key function	31
Enabling/disabling [MIC IN] key during recording	31
Phantom power on/off	31
Basic recording	32
Inserting a storage device	32

Adjusting the recording level	32
When recording a digital source	33
When recording a microphone source	33
Checking the remaining time	33
Start recording	34
Setting a CUE point	35
Setting a CUE point on-the-fly during recording	35
Viewing CUE points	35
Editing a CUE point	36
Editing a CUE label	36
Editing CUE time data	36
Deleting a CUE point	36
Setting a new CUE point using the CUE LIST screen	37

Using an external microphone

Using a microphone for recording	38
Using a microphone during playback	38
Setting in the MIC IN SETUP menu	39
Enabling/disabling the [MIC IN] key	39
[MIC IN] key function	39
Attenuating playback level	40
Enabling/disabling the [MIC IN] key during recording	40
Phantom power on/off	40

Playback

Play mode	41
Playback in SINGLE play mode	41
Selecting a playback file	42
Using the [◀◀] and [▶▶] keys	42
Using the file selection screen	42
Playback in ALL play mode	43
Playback in RELAY play mode	43
Playback in CHAIN SINGLE play mode	44
Playback in CHAIN ALL play mode	44

Playback in MEMORY play mode	45
Playback in TIMER play mode	46
Creating the chain play list	46
Editing the chain play list	47
Editing a point using the time edit function	47
Replacing a point with CUE time	48
Fine-adjusting using digital scrub	49
Inserting a file to the list	49
Deleting a file from the chain play list	50
Creating the timer play list	51
Editing the timer play list	52
Changing a file	52
Editing the time and days of the week	53
Editing the playback area of a file (Using the time edit function)	53
Editing the playback area of a file (Replacing with a CUE time)	53
Cueing function	54
Repeat function	54
Auto play function	54
Power on play function	54
Digital scrub function	55
PLAY SETUP menu details	56
Play mode setting	56
Repeat function	57
Auto play function	57
Power on play function	58
Mono mix function	58

Locate / skip

Skipping among files	59
Skipping among CUE points	59
Locating the beginning of a file	60
Locating the end of a file	60
Locating a CUE point	60
Locating a position by specifying the time	60
Direct locate using the numeric keys	60

Controlling from an external device

Setting REMOTE SET menu	61
Using [PARALLEL REMOTE] connector	61
Using [FOOT SW] jack	62
Setting "Foot SW. Mode"	62
Using the [RS232C] port	63
Setting "RS232C Setup" menu	63
Command control list	64

File transfer between the unit and your computer

Connecting a computer to the unit	65
Copying a file to a computer	66
Copying a file from a computer	66

Using a USB keyboard

Keys on a keyboard and assigned functions	67
Function keys on a USB keyboard	67
Control keys on a USB keyboard	68
Shortcut keys on a USB keyboard	68
Other keys on a USB keyboard	68
Keys on a numeric keyboard	68

Upgrading the UR-2

Executing upgrade file	69
------------------------------	----

MENU mode

About MENU mode	70
SYSTEM SETUP menu details	71
Basic operation of SYSTEM SETUP menu	72
Setting a file name	73
Selecting the input source	74
Selecting the FS and bit	74
Selecting stereo or mono recording mode	75

Setting the maximum file length	75
Setting the peak hold time	76
Setting the reference level	76
Setting cue monitor output destination	77
Setting the output digital signal format	77
Setting the USB keyboard type	78
Saving system memory data	78
Loading the system memory data	79
Initializing the setup data	80
Initializing flash memory	80
Checking the system version	81
STORAGE UTILITY menu details	82
Basic operation of STORAGE UTILITY menu	82
Editing a file name	83
Viewing the file information	83
Copying files	84
Deleting a file	85
Erasing all data on the storage device	86
Editing the volume label	87
Creating a file information file in CSV format	87
Chain play list /Timer play list (examples)	88

Main specifications

Inputs/outputs	89
Recording/playback	89
General	90
Physical dimensions	90
Index	91
Declaration of EC Directive	92
For the US Customers Only (Fostex America Limited Warranty)	93

Introduction

Thank you very much for purchasing the Model UR-2 recorder. Read this manual and follow all instructions before using this unit, and retain it for future reference.

Precautions

- You can supply the power either from the dedicated Fostex AC adaptor or external battery. When you use an external battery, be sure that the battery can stably supply the rated power voltage.
- While the unit is accessing a storage device (an SD card or USB memory) (i.e. during recording or playback), do not turn off the power or remove the device. Otherwise, recorded data may be lost or the storage device may be damaged. Make sure that the unit completely stops accessing the storage device and the access indicator is unlit before you remove the device.
- Do not let water or other liquid, or metal objects such as pins, accidentally enter the inside of the unit because this may lead to electric shock or damage. Should water enter the inside of the unit, turn off the power, unplug the AC adaptor, and consult your dealer or the nearest FOSTEX service station.
- Do not drop the unit or give it a strong shock. Doing so may damage the internal circuits, display or panels. Handle the unit with great care because it is a precision mechanical device.
- Do not open the case or touch inside the unit because of the danger of electric shock and failure.

<About replacing the lithium battery>

The unit contains the internal lithium battery for running the internal clock. The battery should be replaced approximately every five years. To replace the battery, ask your dealer or the nearest FOSTEX service station. If the battery is not correctly replaced, there may be a risk of explosion, etc.

Precautions on installation

- Do not install the unit in the following conditions.
 - * In an extremely hot or cold place
 - * In a moist place
 - * In a vibrated place
 - * In a dusty place
 - * In a strong magnetic field or near a device which generates a magnetic field
 - * In the direct sunshine
 - * In the direct shower or rain
- When you mount the unit to an EIA rack, use the appropriate mounting screws (note that the mounting screws are not supplied with the unit).

It is recommended to leave at least one empty rack space above and below the unit for reducing the amount of heat transferred.

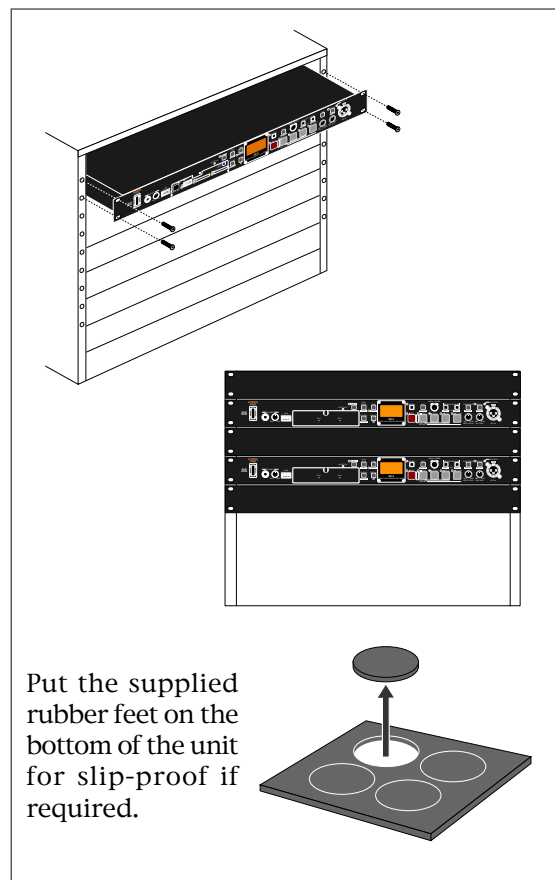

About storage devices

The unit uses an SD card (SDHC supported) or USB memory as a storage device for recording and playback.

It supports both FAT 16 and FAT 32 file formats. For an SD card, the maximum recording capacity is 32 GB, while the minimum recording capacity is 128 MB. For a USB memory, the maximum recording capacity is not limited.

You can use any SD card or USB memory which is FAT 16/32 formatted.

<Note>: Please note that due to a compatibility problem between the unit and the controller on a USB memory, the unit may not recognize the USB memory or recording may become unstable.

<Note>: In this manual, we sometimes call an SD card or USB memory used for recording and playback of the unit as a "storage device".

Formatting of a storage device

After you buy a new storage device (an SD (SDHC) card or USB memory), you do not need to format it before using with the unit.

However an SD (SDHC) card which has been formatted using a formatting software for a computer cannot be used with the unit (though a USB memory which has been formatted using a formatting software for a computer can be used with the unit).

To use such an SD (SDHC) card with the unit, download the software (freeware) from the SD Association website (see URL below) and format the card using it. This software formats an SD (SDHC) card to conform to the SD or SDHC specification (see the SD Association website for details).

<http://www.sdcard.org/about/downloads/>

About version upgrade

The software of the unit may be upgraded with the feature/function enhancement.

You can check the latest software version information via the Fostex website (<http://www.fostex.com>) or your nearest Fostex service station.

You can download the upgrade via the Fostex website and upgrade the unit by yourself. See page 69 of this manual for details.

Notes on moisture condensation

When you bring the unit from a cold place to a warm place, moisture may condense on the drive, display, panels, etc. In such a case, leave the unit for a while until it warms up and evaporates any moisture.

Overview

Main features

- You can make stereo or mono recording/playback of the WAV (BWF) file using an SD card or USB memory.
- You can make recording at "16-bit, 44.1 or 48 kHz" or "24-bit, 44.1, 48, 88.2 or 96 kHz".
- A USB 2.0 port is provided for high-speed file transfer between a computer and the UR-2.
- The unit is equipped with two SD card slots and a USB port ([USB-HOST]) dedicated for a USB memory. You can record a file to an SD card or a USB memory. You can even make continuous playback over storage devices. Note that you cannot use a USB memory while a computer is connected to the [USB-PC] port.
- Supporting the FAT file format, you can use an SD card or a USB memory which has been used with the unit to a computer.
- Comprehensive playback functions including chain play and memory play allow you to use the unit in various circumstances.
- Functions such as timer play or power-on play are useful for an audio installation system. You can ring a chime or broadcast a regular announcement.
- Each play mode list can be created in the form of CSV format, allowing editing easily using a text editor or a spreadsheet software on PC.
- When creating the chain play list, you can fine-adjust the start and end points by checking the waveform on the display using the digital scrub function.
- A microphone input connector supporting the +48 V phantom power is provided on the front panel. Not only you can record a microphone source, but also you can mix an announcement from the microphone with the playback sound.
- In addition to the balanced (XLR) and unbalanced (RCA) analog inputs/outputs, the unit provides the digital input and output (XLR) ports.
- The organic electroluminescence display provides high level of visibility including wide viewing angle and high contrast.
- Supports external controls via the footswitch, parallel remote (D-sub 25-pin connector) and RS232C (D-sub 9-pin connector).
- A dedicated USB port for a USB keyboard is provided. You can edit a file name as well as control the transport from a USB keyboard.
- By adopting DC power supply, you can supply power from an external battery as well as from the AC adaptor. This is a great advantage for outdoor event or location recording.
- By installing the optional MIDI port (available soon), you can use MMC and MTC.

Names and functions

Front panel

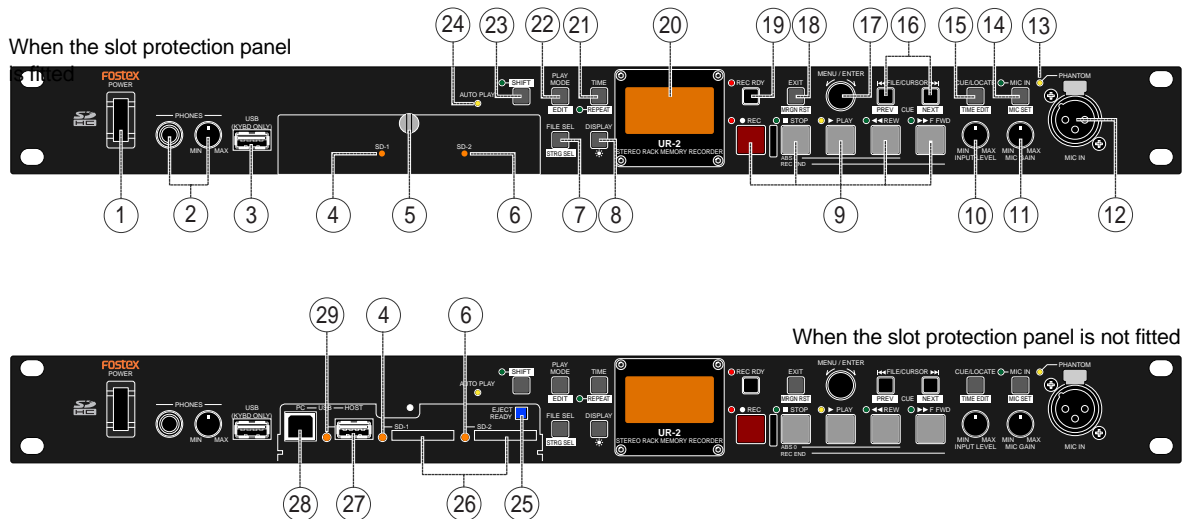

About Non-shift mode and Shift mode

*Some keys have the secondary function which is available when the SHIFT indicator is lit (i.e. in the Shift mode), while the primary function is available when the SHIFT indicator is unlit (i.e. in the Non-shift mode).

The secondary function is called "Shift function" and printed under a key on the white background. When you turn on the power, the unit boots up in the Non-shift mode.

In this manual, we sometimes say "when SHIFTed" and "when unSHIFTed", instead of "when the SHIFT indicator is lit" (or "in the Shift mode") and "when the SHIFT indicator is unlit" (or "in the Non-shift mode") respectively.

- 1) **[POWER] switch**
Turns on or off the power of the unit.
- 2) **[PHONES] jack, [PHONES] control**
You can connect a stereo headphones plug to the [PHONES] jack and control the headphones volume using the [PHONES] control.
- 3) **[USB (KYBD ONLY)] port**
This port is used for connecting a USB keyboard. When you use a USB keyboard, set the keyboard type (US or JAPAN) appropriately using the "Keyboard type" menu item in the "SYSTEM SETUP" menu of the MENU mode (see page 78 for details).

- 4) **[SD-1] indicator**
Indicates the condition of the SD card inserted on the [SD-1] slot. You can see the indicator regardless of whether or not the slot protection panel is fitted.
 - Lit in orange: The unit is reading data.
 - Lit in red: The unit is writing data.
 - Lit in green: The unit is not accessing the SD card.
 - Unlit: No SD card is inserted or the unit is in sleep mode.
- 5) **Fixing screw for the slot protection panel**
The protection panel protects the card slots and USB port for the storage devices. To access the slot/port, loosen the fixing screw and **open** the slot protection panel (see page 26 for details).
- 6) **[SD-2] indicator**
Indicates the condition of the SD card inserted on the [SD-2] slot. You can see the indicator regardless of whether or not the slot protection panel is fitted. See [SD-1] indicator above for the indicator status.
- 7) **[FILE SEL] / [STRG SEL] key**
This key has primary (unSHIFTed) and secondary (SHIFTed) functions.

When unSHIFTed:
Pressing this key enters the file select mode (see page 42).

When SHIFTed:

Pressing this key enters the storage select mode (see page 28).

8) [DISPLAY] / [☼] key

This key has primary (unSHIFTed) and secondary (SHIFTed) functions.

When unSHIFTed:

Pressing this key switches the display mode (see page 25).

When SHIFTed:

Pressing this key enters the display brightness control mode (see page 24).

9) Transport control key

[▶] PLAY key

Pressing this key starts playback. Pressing this key while holding down the [STOP] key starts digital scrubbing (see page 55).

[●] REC key

Pressing this key while the [REC RDY] indicator is lit starts recording (see page 35).

[■] STOP key

Pressing this key stops playback or recording. When the unit is stopped, pressing the [REW] or [F FWD] key while pressing down this key skips to the beginning or the last recording position of the current file.

[◀◀] REW key

Pressing this key while stopped starts fast-rewind at up to 30 times the normal playback speed. Pressing this key during playback executes backward cueing playback (see page 54). While stopped, pressing this key while holding down the [STOP] key skips to the beginning (ABS 0) of the current file (see page 60).

[▶▶] F FWD key

Pressing this key while stopped starts fast-forward at up to 30 times the normal playback speed. Pressing this key during playback executes forward cueing playback (see page 54). While stopped, pressing this key while holding down the [STOP] key skips to the last recording position of the current file (see page 60).

10) [INPUT LEVEL] control

Adjusts the input level of analog signals fed to the [ANALOG INPUT] connectors (see page 33). You can check and adjust the input level in the input monitor mode.

11) [MIC GAIN] control

Adjusts the input gain of an external microphone signal fed to the [MIC IN] connector on the front panel.

12) [MIC IN] connector

Connects an external microphone. By turning on the [MIC IN] indicator by pressing the [MIC IN] key, you can make recording using an external microphone as well as can mix playback signal of a file playback and an external microphone signal. You can supply the phantom power to the [MIC IN] connector (see page 40).

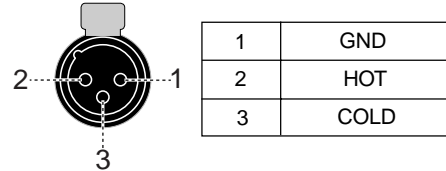

13) [PHANTOM] indicator

By setting the "Phantom" menu item in the MIC IN SETUP menu of the MENU mode to "On", the phantom power is supplied to the [MIC IN] connector and this indicator is lit (see page 40).

14) [MIC IN] / [MIC IN] indicator, [MIC SET] key

This key has primary (unSHIFTed) and secondary (SHIFTed) functions.

When unSHIFTed:

Pressing this key switches on or off the microphone input. When on, the indicator lights up. When off, it is unlit (see page 34).

If you press this key to switch on the microphone input during recording, the microphone input takes priority and you can start microphone recording (see pages 34 and 38). If you switch on the microphone input during playback, you can mix the microphone signal to the playback signal (see pages 38 and 42).

When SHIFTed:

Pressing this key enters the MIC IN SETUP menu of the MENU mode. In this menu, you can make settings for using an external microphone. (see page 39).

15) [CUE/LOCATE] / [TIME EDIT] key

This key has primary (unSHIFTed) and secondary (SHIFTed) functions.

When unSHIFTed:

During recording, pressing this key sets a CUE mark at the current position on-the-fly (see page 35).

While stopped or during playback, pressing this key brings up the CUE list. While the list is shown, you can skip to the desired CUE mark or edit the CUE label and time data (see page 35).

When SHIFTed:

Pressing this key enters the time edit mode. Pressing this key again after editing the time locates the edited time position (see page 60).

- 16) **[◀◀ FILE/CURSOR ▶▶] key, [PREV] CUE [NEXT] keys**
 These keys have primary (unSHIFTed) and secondary (SHIFTed) functions.
- When unSHIFTed:**
 Pressing the key skips to the beginning of the previous or next file (see page 59).
 While the display shows a file name entry screen in the MENU mode, pressing the key moves the cursor position.
- When SHIFTed:**
 Pressing the key skips to the previous or next CUE point (see page 59).
- 17) **[MENU] dial / [ENTER] key**
 This knob has dual functions: the [MENU] dial for selecting an option and the [ENTER] key for confirming the selection.
- [ENTER] key function:**
 Pressing the [ENTER] key while stopped enters the MENU mode (see page 70).
- [MENU] dial function:**
 In the MENU mode, rotating the [MENU] dial selects the menu item, selects an alphanumeric character, etc.
- 18) **[EXIT] / [MRGN RST] key**
 This key has primary (unSHIFTed) and secondary (SHIFTed) functions.
- When unSHIFTed:**
 Pressing this key exits the MENU mode or cancels setting operation.
- When SHIFTed:**
 In the input monitor mode or during recording, pressing this key resets the margin indication which shows remaining margin to the peak level.
- 19) **[REC RDY] key and indicator**
 Pressing the key switches on or off the input monitor mode. When on, the indicator starts flashing. When recording starts, it lights solid (see page 33).
- 20) **Organic electroluminescence display**
 Displays the audio level during recording or playback, time information, etc., as well as a menu screen (see page 17).
- 21) **[TIME] / [REPEAT] key, [REPEAT] indicator**
 This key has primary (unSHIFTed) and secondary (SHIFTed) functions.
- When unSHIFTed:**
 Pressing the key switches the display mode between the time display and the remain display on the Home screen (see page 34).
- When SHIFTed:**
 Pressing the key switches the repeat mode on or off (see page 54).
 When the repeat mode is on, the indicator lights.
- 22) **[PLAY MODE] / [EDIT] key**
 This key has primary (unSHIFTed) and secondary (SHIFTed) functions.
- When unSHIFTed:**
 Pressing this key switches the play mode (see page 41).
- When SHIFTed:**
 Depending on the current play mode, pressing this key enters the PLAY SETUP menu or CHAIN PLAY SET menu of the MENU mode.
- 23) **[SHIFT] key and indicator**
 Pressing this key switches between the Shift and non-shift mode. In the Shift mode, the indicator lights. In the non-shift mode, the indicator is unlit.
- 24) **[AUTO PLAY] indicator**
 This indicator lights when the auto play mode is on. The auto play mode can be set using the "Auto play" item in the PLAY SETUP menu of the MENU mode (see page 57).
- 25) **[EJECT READY] key**
 Press this key before you remove a storage device (SD card or USB memory) from the slot when the power is on (see page 27).
- 26) **SD card slots [SD-1] and [SD-2]**
 You can set an SD card to each slot (see page 26).
- 27) **[USB-HOST] port**
 This port is used for connecting a USB memory (see page 26).
- 28) **[USB-PC] port**
 This port is used for connecting a computer (see page 27).
- <Note>:** You cannot use the [USB-HOST] and [USB-PC] ports simultaneously.
- 29) **[USB] indicator**
 Indicates the condition of the USB memory inserted on the [USB-HOST] port.
- Lit in orange: The unit is reading data.
 - Lit in red: The unit is writing data.
 - Lit in green: The unit is not accessing the USB memory.
 - Unlit: No USB memory is inserted or the unit is in sleep mode.

Rear panel

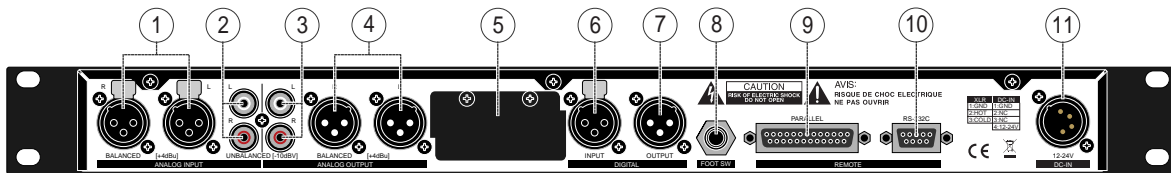

- 1) **[ANALOG INPUT L/R (BALANCED)] connectors**
 These connectors are the XLR-3-31 type and accept +4dBu analog signals.

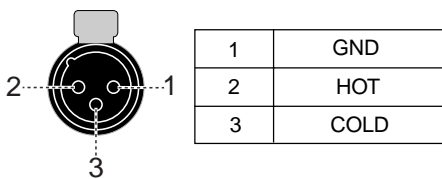

<Note>: When a plug is connected to the unbalanced RCA jack, the balanced input is cut.

- 2) **[ANALOG INPUT L/R (UNBALANCED)] connectors**
 These connectors are RCA pin jack type and accept -10 dBV analog signals.
- 3) **[ANALOG OUTPUT L/R (BALANCED)] connectors**
 These connectors are the XLR-3-32 type and send +4dBu analog signals.

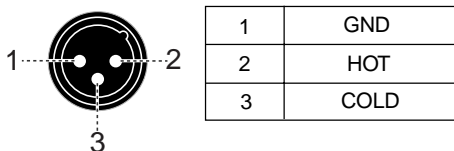

- 4) **[ANALOG OUTPUT L/R (UNBALANCED)] connectors**
 These connectors are RCA pin jack type and send -10 dBV analog signals.
- 5) **Blank panel**
 You can install the optional MIDI IN/OUT board here (available soon).
- 6) **[DIGITAL INPUT (BALANCED)] connector**
 This connector is the XLR-3-31 type and accepts a digital signal conformed to IEC-60958 (AES/EBU) or IEC-60958 (S/P DIF). The unit automatically recognizes the digital signal format.

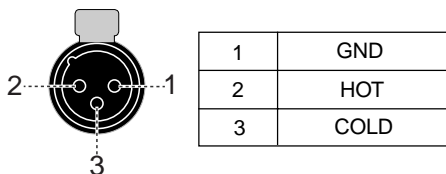

- 7) **[DIGITAL OUTPUT (BALANCED)] connector**
 This connector is the XLR-3-31 type and sends a digital signal conformed to IEC-60958 (AES/EBU) or IEC-60958 (S/P DIF). The digital output signal format can be selected via the SYSTEM SETUP menu of the MENU mode (see page 77).

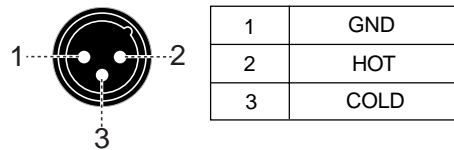

- 8) **[FOOT SW] jack**
 By connecting a footswitch or fader start terminals to this jack, you can start or stop playback (page 61).
- 9) **[REMOTE PARALLEL] connector**
 This connector is the D-sub 25 pin type and used for controlling the unit from an external device (see page 61).

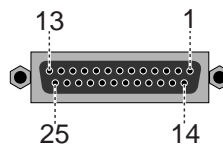

Pin No.	Signal	IN/OUT
1	STOP TALLY	OUT (OC)
2	REC TALLY	OUT (OC)
3	STOP	IN
4	REC	IN
5	FF (SKIP)	IN
6	SHIFT	IN
7	10key-0	IN
8	10key-2	IN
9	10key-4	IN
10	10key-6	IN
11	10key-8	IN
12	FOOT SW	IN
13	GND	—
14	PLAY TALLY	OUT (OC)
15	+10key	IN
16	PLAY	IN
17	REC RDY	IN
18	REW (SKIP)	IN
19	MIC IN	IN
20	10key-1	IN
21	10key-3	IN
22	10key-5	IN
23	10key-7	IN
24	10key-9	IN
25	VCC (+5V)	—

OC: Open corrector

10) [REMOTE RS232C] connector

This RS232C connector is the D-sub 9 pin type and used for controlling the unit from a computer, etc. (see page 61).

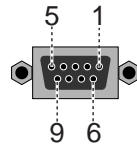

Pin No.	Signal	IN/OUT
1	NC	—
2	TX	OUT
3	RX	IN
4	NC	—
5	GND	—
6	NC	—
7	NC	—
8	NC	—
9	NC	—

11) [DC-IN] connector

This connector is the XLR-4-32 type and accepts the DC power from 12 V to 24 V. Connect the supplied AC adaptor or an appropriate external battery.

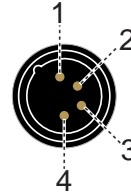

1	GND
2	NC
3	NC
4	12-24V

Screen details

When the unit starts up, the Home screen is shown. The Home screen displays the current file information, the level meters and the current status.

Home screen in stop or playback mode

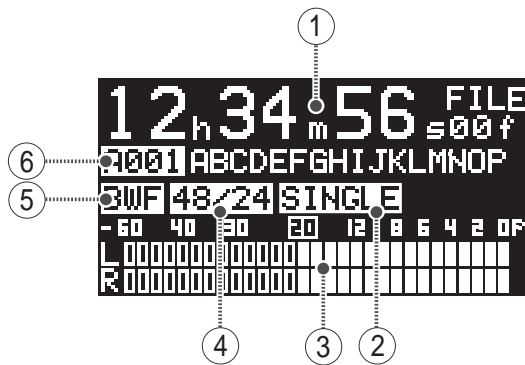

- 1) **Time information**
While stopped or during playback, the current playback position is shown. Pressing the [TIME] key switches between the time display and the remain display. Also the appropriate icon (▶, ▶▶, ◀◀) which shows transport status is lit in the top right of the display during playback, fast forward or rewind.
- 2) **Play mode**
The currently selected play mode is shown (by default, SINGLE). You can switch the play mode by pressing the [PLAY MODE] key (see page 41).
- 3) **Level meters**
The playback levels are displayed during playback. The meters show no levels while stopped. The reference level is -20 dBFS by default (see page 76).

- 4) **Sampling frequency/quantization bit**
The Fs and bit information of the current file (BWF) is displayed.
- 5) **File format**
The file format of the current file is displayed.
- 6) **File number/file name**
The file number and file name are displayed. You can edit the file name using the "Edit File Name" item in the STORAGE UTILITY menu of the MENU mode (see page 83).

The first alphabetical character in a file number shows the storage device where the current file is recorded.

A001	"A" is shown when a file recorded on an SD card set to SD-1 is loaded.
B001	"B" is shown when a file recorded on an SD card set to SD-2 is loaded.
C001	"C" is shown when a file recorded on an USB memory set to the [USB-HOST] port is loaded.

Home screen in record or input monitor mode

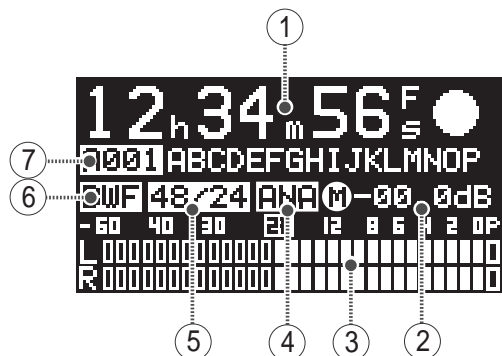

- 1) **Time information**
 During recording or in input monitor mode, the current recorder position is shown. Pressing the [TIME] key switches between the time display and the remaining time display of the storage device.
 Also the record icon (●) is lit in the top right of the display during recording.
- 2) **Margin**
 The margin of the input signal level is displayed during recording or in input monitor mode. The margin display can be reset by pressing the [MRGN RST] key in shift mode.
- 3) **Level meters**
 The input (recording) levels are displayed during recording or in the input monitor mode (see page 33).
- 4) **Input source**
 The currently selected input source (DIG, ANA or MIC) is displayed. You can select DIG (Digital) or ANA (Analog) using the "Select input" item in the SYSTEM SETUP menu of the MENU mode (Note that even if you select Digital, when the unit does not lock to the digital input signal, DIG flashes quickly).
 When turning on the [MIC IN] indicator by pressing the [MIC IN] key, MIC is selected (see page 34).
- 5) **Sampling frequency/quantization bit**
 The Fs and bit information of the current file is displayed. You can select the desired Fs and bit using the "Record FS/bit" item in the SYSTEM SETUP menu of the MENU mode (see page 74).
- 6) **File format**
 The file format of the current file (BWF) is displayed.

- 7) **File number/file name**
 In the input monitor mode, "NEXT" is displayed in the file number field, while the file name of the next recording is displayed in the file name field.

During recording, the current file number and file name are displayed.

As with the file number shown on the Home screen in stop or playback mode, the first alphabetical character in a file number shows the storage device where the current file is recorded (such as A001, B001 and C001).

The file name format depends on the selection of the "Default file name" item in the SYSTEM SETUP menu of the MENU mode (see page 73).

• When Date is selected:

The internal realtime clock data when recording starts (with ".wav", the file extension) is set to the file name.

Example: B15h09m27s10aug2008.wav

• When Take is selected (default):

"Scene name + Take Number" (with ".wav", the file extension) is set to the file name.

Example: SCENE_001.wav

• When Reel is selected:

"Reel number + File number" (with ".wav", the file extension) is set to the file name.

Example: 12082008_001.wav

Screens in MENU mode

When the unit enters the MENU mode by pressing the [ENTER] key while the unit is stopped, the menu list screen as below is shown. There are ten main menus. To bring up a main menu screen, use the [MENU] dial to highlight a desired main menu from the menu list and press the [ENTER] key.

```
MENU▶
▼SYSTEM SETUP ▶
PLAY SETUP ▶
STORAGE UTILITY▶
FILE SEL ▶
STORAGE SEL ▶
MIC IN SETUP ▶
```

- **SYSTEM SETUP menu**

By highlighting "SYSTEM SETUP" in the menu list and pressing the [ENTER] key, the following screen is shown. In the SYSTEM SETUP menu, you can make system settings (see page 71).

```
M▶SYS▶
▼Default file name▶
Select input:Analog
Record FS/bit:44k/16
Record CH. :Stereo
Record mode :Normal
MAX. file length:4G
```

- **PLAY SETUP menu**

By highlighting "PLAY SETUP" in the menu list and pressing the [ENTER] key, the following screen is shown. In the PLAY SETUP menu, you can make settings regarding playback functions (see page 56).

```
MENU▶PLAY▶
▼Play mode :ALL PLAY
Repeat : Off
Auto play mode : Off
Power on play : Off
Mono mix : Off
```

- **FILE SEL menu**

By highlighting "FILE SEL" in the menu list and pressing the [ENTER] key, the following screen is shown. In the FILE SEL menu, you can select a file to be played back (see page 42).

```
FILE SEL
[NO] [NAME]
001 Original_001.wav
002 Original_002.wav
003 Original_003.wav
004 Original_004.wav
005 Original_005.wav
```

- **STORAGE UTILITY menu**

By highlighting "STORAGE UTILITY" in the menu list and pressing the [ENTER] key, the following screen is shown. In the STORAGE UTILITY menu, there are menu items regarding storage devices and recorded files (see page 82).

```
M▶STORAGE: A▶
▼Edit file name ▶
File info. ▶
File copy ▶
Delete file ▶
Report file list▶
Card all erase ▶
```

- **MIC IN SETUP menu**

By highlighting "MIC IN SETUP" in the menu list and pressing the [ENTER] key, the following screen is shown. In the MIC IN SETUP menu, you can make settings for using an external microphone (see page 39).

```
M▶MIC▶
▼Mic in :Enable
Switch hold :On
Play ATT. :-6dB
Mic record :Enable
Phantom :Off
```

- **CHAIN PLAY SET menu**

By highlighting "CHAIN PLAY SET" in the menu list and pressing the [ENTER] key, the following screen is shown. In the CHAIN PLAY SET menu, you can make playlist which is used in chain play (see page 46).

```
CHAIN PLAY SET
TOTAL TIME:00h00m00s
[LN][FN] [NAME]
▼001 -----
<SAVE>
<ALL CLEAR>
```

- **TIMER PLAY SET menu**

By highlighting "TIMER PLAY SET" in the menu list and pressing the [ENTER] key, the following screen is shown. In the TIMER PLAY SET menu, you can set the start time and end time which are used in timer play (see page 51).

```
TIMER PLAY SET
[TN][TIME] [FILE]
▼001 --:-- -----
<SAVE>
<ALL CLEAR>
```

REMOTE SET menu

By highlighting "REMOTE SET" in the menu list and pressing the [ENTER] key, the following screen is shown. In the REMOTE SET menu, you can make settings for controlling the unit remotely (see page 61).

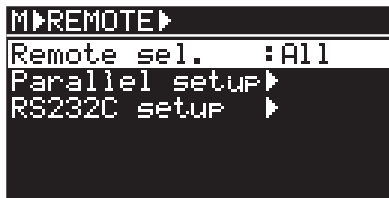

USB to PC menu

By highlighting "USB to PC" in the menu list and pressing the [ENTER] key, the following screen is shown. In the "USB to PC" menu, you can make settings for transferring files between the unit and a computer (see page 65).

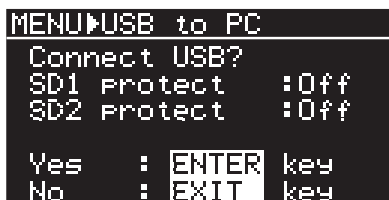

STORAGE SEL menu

By highlighting "STORAGE SEL" in the menu list and pressing the [ENTER] key, the following screen is shown. Alternatively you can bring up this screen by pressing the [FILE SEL] / [[STRG SEL] key in SHIFT mode. In the STORAGE SEL menu, you can select the current storage device for recording/playback (see page 28).

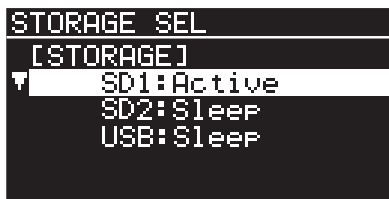

Other screens

EJECT READY screen

Pressing the [EJECT READY] key while the unit is stopped brings up the following screen. Use this screen when you eject the current storage device (see page 27).

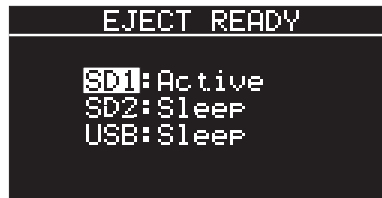

Memory play screen

When you set the play mode to "MEMORY", the memory play screen is shown (see page 45). The memory play screen is shown only when the playlist for memory play is created (see page 46).



Timer play screen

When you execute timer play, the timer play screen is shown (see page 45). The timer play screen is shown only when the playlist for timer play is created (see page 51).

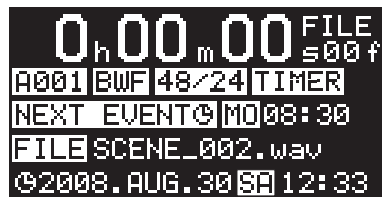

Chain play screen

When you execute chain play, the "CHAIN-S" or "CHAIN-A" screen is shown (see page 44). The chain play screen is shown only when the playlist for chain play is created (see page 46).

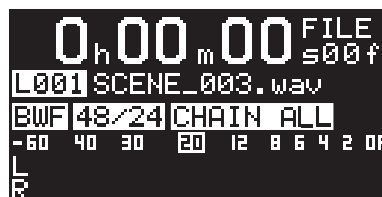

Preparation

Connection to external devices (from the front panel)

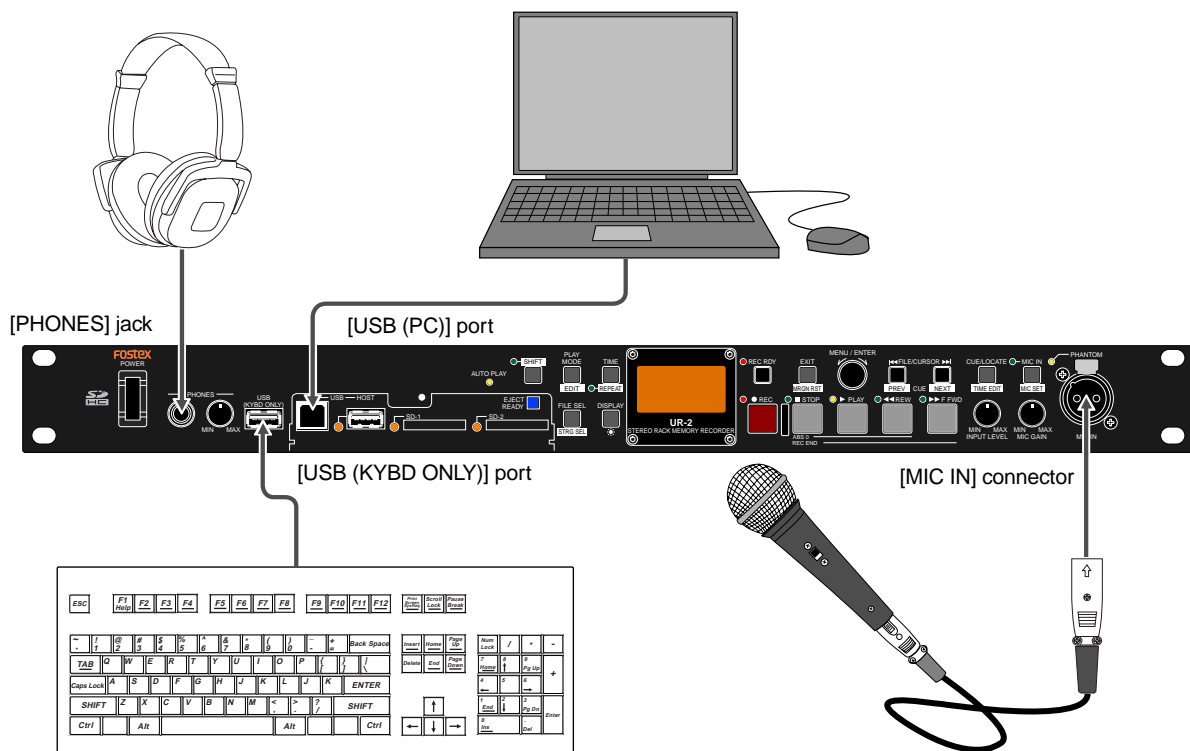

Connection of headphones

Connect headphones to the [PHONES] jack. Use the [PHONES] control to adjust the headphone level.

Connection to a computer

Connect a computer to the [USB-PC] (USB 2.0) port. You can transfer a file between the unit and computer at high speed (see page 65).

<Note>: When a USB memory is connected to the [USB HOST] port, you cannot use the [USB-PC] (USB2.0) port.

Connection of a USB keyboard

Connect a USB keyboard (or a numeric keyboard) to the [USB (KYBD ONLY)] port. You can edit a file name and control the transport from a USB keyboard (see page 67).

<Note>: When you use a USB keyboard, set the keyboard type (US or JAPAN) appropriately using the "Keyboard Type" menu item in the "SYSTEM SETUP" menu of the MENU mode (see page 78 for details).

Connection of an external microphone

Connect an external microphone to the [MIC IN] connector. To enable the microphone input, press the [MIC IN] key to turn on the [MIC IN] indicator.

The [MIC IN] connector supports +48 V phantom power, therefore, you can use a condenser microphone.

<Note>: For details about how to use an external microphone with the unit, see "Using an external microphone" (page 38).

Connection to external devices (from the rear panel)

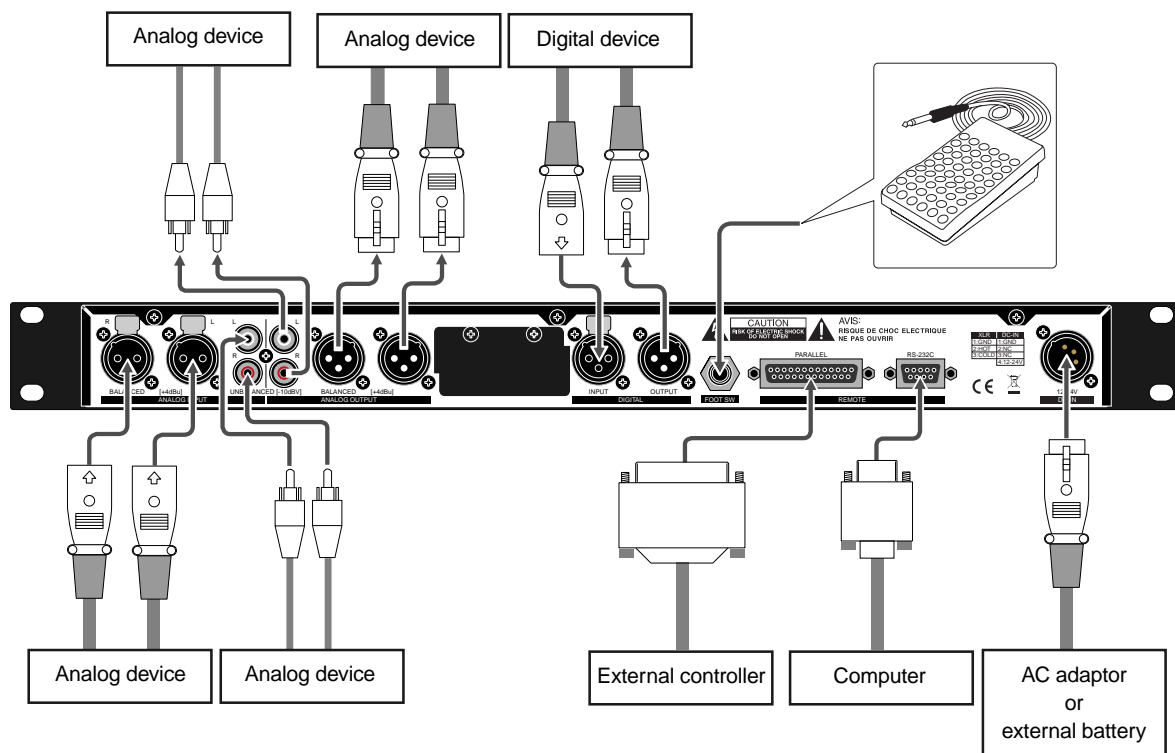

Analog audio connection

For analog audio input/output connection, the UR-2 provides both the +4 dBu balanced XLR and -10 dBV unbalanced RCA input/output connectors.

<Note>: You cannot use the XLR and RCA inputs simultaneously. If you connect devices to both inputs, the RCA input is enabled.

Digital audio connection

For digital audio input/output connection, the UR-2 provides the balanced XLR connectors which support IEC-60958 (AES/EBU) and IEC-60958 (S/P DIF).

The unit automatically recognizes the digital signal format, while the digital output signal format can be selected via the "Digital out" menu item in the SYSTEM SETUP menu of the MENU mode (see page 77).

Footswitch or equipment with fader start terminal

By connecting a footswitch or fader start terminal to the [FOOT SW] jack, you can start or stop playback (page 61).

Power connection

Connects the supplied AC adaptor or an appropriate external battery with the DC power from 12V to 24V to the [DC IN] connector.

The connector is the XLR-4-32 type.

<Note>: When you supply the power from an external battery, make sure that the battery can supply stable rated voltage.

RS232C connection

By connecting the [REMOTE RS232C] connector to the RS-232C port of a computer, you can control the unit from the computer (see page 61).

Parallel remote connection

By using the [REMOTE PARALLEL] connector, you can control the unit from an external controller.

The [REMOTE PARALLEL] connector is the D-sub 25 pin type. For details about the pin assignment of the [REMOTE PARALLEL] connector, see "Parallel remote control" on page 61.

Turning on the power

By pressing the [POWER] switch, you can power on the unit.

If the unit starts up without any storage devices inserted, the display shows the following Home screen.

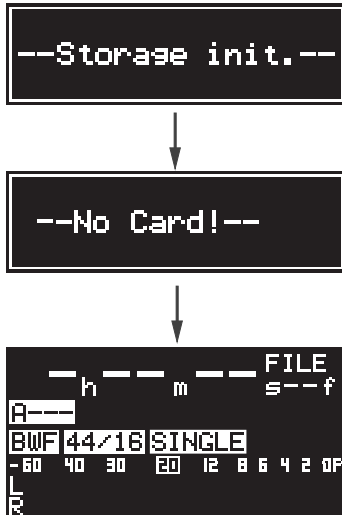

For details about the display shown when starting up the unit with a storage device inserted, see "Setting a storage device" on page 26.

Turning off the power

To turn off the power, simply press the [POWER] switch.

However, during playback or recording, the [POWER] switch is disabled and you cannot turn off the power by pressing the [POWER] switch.

Setting the internal clock

The UR-2 has the internal clock, which is adjusted according to the local time when shipped. Therefore, set the time to your local time before using the unit.

The internal clock time is used for the default file name of a file which is created when recording, the file creation date/time, the time stamp of a BWF file, and the start time of the timer play function. Therefore, it is recommended to set the internal clock correctly.

<Note>: To add the time data to a file name, set the "Default File name" item in the SYSTEM SETUP menu of the MENU mode appropriately (see page 73).

- 1) Press the [ENTER] key to enter the MENU mode.

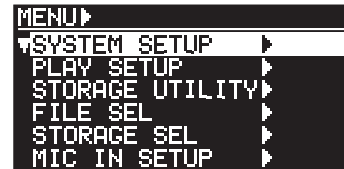

- 2) While "SYSTEM SETUP" is highlighted, press the [ENTER] key.

The display now shows the menu items of the SYSTEM SETUP menu.

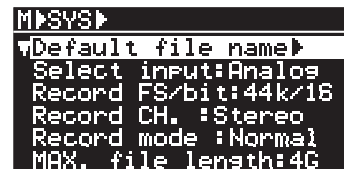

- 3) Use the [MENU] dial to highlight "Adjust RTC." and press the [ENTER] key.

The display now shows the current date/time of the internal clock.

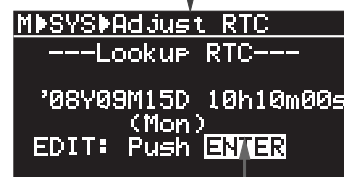

Flashing

- 4) **Press the [ENTER] key.**
 The second digit starts flashing.
 You can edit the value at the flashing point using the [MENU] dial.
 You can move the flashing point using the [◀◀] and [▶▶] keys.

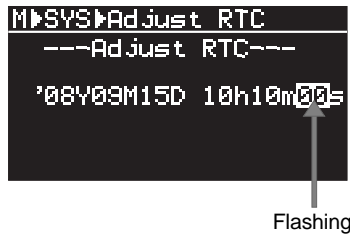

<Memo>: When a USB keyboard is connected to the unit, you can also enter time data from the keyboard (see page 67).

- 5) **After editing time data, press the [ENTER] key to confirm the editing.**
 By pressing the [ENTER] key at the timing of time signal, you can set the exact time.
- 6) **Press the [STOP] key to exit the MENU mode.**
 You can also exit the MENU mode by pressing the [EXIT] key repeatedly.

<Memo>: The unit has an internal lithium battery which is used for driving the realtime clock. The battery life is approximately four or five years. Battery replacement must be performed by an authorized person only.

If the following message appears on the display, ask your local Fostex dealer or sale office for battery replacement.

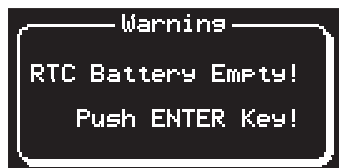

Adjusting the display

You can adjust the brightness of the display, inverse the display and enlarge the file name display.

In the following description, it is assumed that the unit is stopped.

Adjusting the brightness of the display

- 1) **Press the [SHIFT] key to enter the shift mode (light up the SHIFT indicator) and press the [DISPLAY] / [☀] key.**
 The following popup window appears on the display.



- 2) **Use the [MENU] dial to adjust the brightness and press the [ENTER] key to confirm the setting.**
 The default brightness value is the maximum brightness. Pressing the [ENTER] key dismisses the popup window.

Inversing the display

- 1) **Press the [ENTER] key to enter the MENU mode.**



- 2) **While "SYSTEM SETUP" is highlighted, press the [ENTER] key.**
 The display now shows the menu items of the SYSTEM SETUP menu.

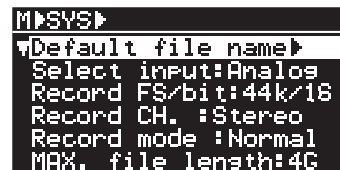

- 3) **Use the [MENU] dial to highlight "Display INV." and press the [ENTER] key.**

The current setting (Off by default) flashes.
You can select Off or On.

```
M>SYS▶
REF. level :-20dB
Cue monitor out :ALL
Digital out :AES/EBU
Display INV. :Off
Keyboard type:US
SYS. user save▶
```

```
M>SYS▶Display INV.
REF. level :-20dB
Cue monitor out :ALL
Digital out :AES/EBU
Display INV. :Off
Keyboard type:US
SYS. user save▶
```

Flashing

- 4) Use the [MENU] dial to select "On" and press the [ENTER] key.
The display is inverted.

```
M>SYS▶Display INV.
REF. level :-20dB
Cue monitor out :ALL
Digital out :AES/EBU
Display INV. :On
Keyboard type:US
SYS. user save▶
```

```
M>SYS▶
REF. level :-20dB
Cue monitor out :ALL
Digital out :AES/EBU
Display INV. :On
Keyboard type:US
SYS. user save▶
```

- 5) Press the [STOP] key to exit the MENU mode.
You can also exit the MENU mode by pressing the [EXIT] key repeatedly.

<Memo>: When you set "Display INV." to "On", the display looks like the following (the following shows the Home screen when no storage device is inserted).

```
  _ h _ _ _ m _ _ _ FILE
  s _ _ f
A _ _ _
BWF 44/16 SINGLE
-60 40 30 20 12 8 6 4 2 0P
L
R
```

Enlarging the file name display

In Non-shift mode (when the SHIFT indicator is unlit), pressing the [DISPLAY] / [⊛] key switches the display as follows.

<While the unit is stopped>

```
0 h 00 m 00 FILE
A001 SCENE_001.wav
BWF 44/16 SINGLE
-60 40 30 20 12 8 6 4 2 0P
L
R
```

<Normal display>

```
0 h 00 m 00 FILE
A001 SCENE_001.wav
S# : G
-60 40 30 20 12 8 6 4 2 0P
L
R
```

<Playback position display>
While playback proceeds, the runner moves from S (start) towards G (goal).

```
0 h 00 m 00 FILE
A001 BWF 44/16 SINGLE
SCENE_001.w
av
```

<Enlarged file name>

<During recording>

```
0 h 00 m 34 F ●
A001 SCENE_001.wav
BWF 44/16 ANA ( ) -00.0dB
-60 40 30 20 12 8 6 4 2 0P
L
R
```

<Normal display>

```
0 h 00 m 34 F ●
A001 BWF 44/16 ANA
SCENE_001.w
av
```

<Enlarged file name>

Inserting a storage device

To insert a storage device, loosen the fixing screw and open the protection cover for the slots (you can remove the cover by opening it approximately 45 degrees and pulling it up).

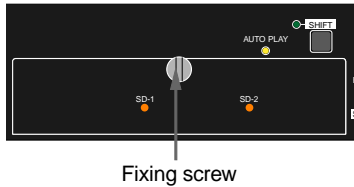

You can insert up to three storage devices into the slots/ports: two SD (SDHS) cards to the [SD-1] and [SD-2] slots and a USB memory to the [USB HOST] port. If you insert more than one storage device after turning on the power, the first device you insert is selected as the current storage device.

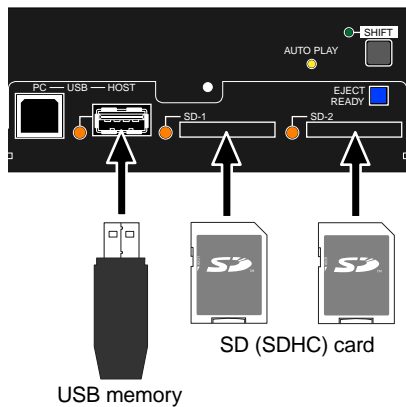

<Memo>: The protection cover can be closed even when both the [SD-1] and [SD-2] slots are occupied.

<Note>: See "Changing the current storage device" described on page 28 for details about how to change the current storage device when more than one device is inserted.

<Memo>: When you turn on the power with more than one storage device inserted, the following device is selected as the current storage device preferentially.

Storage device inserted			The storage device selected as the current storage device preferentially
SD-1	SD-2	USB	
●	●	—	SD card on the [SD-1] slot
●	—	●	SD card on the [SD-1] slot
—	●	●	SD card on the [SD-2] slot
●	●	●	SD card on the [SD-1] slot

For example, when an unrecorded SD card is inserted, the unit turns on the [SD-1] indicator in green and brings up the following screen after reading the card information.

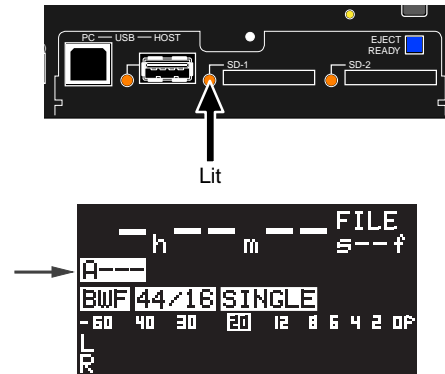

"A" is added to the beginning of a file number. This means the SD card on the [SD-1] slot is now selected as the current storage device.

You can also see the file format, FD/bit and play mode under the file number. On the screen example below, they are "BWF", "44/16" and "SINGLE". When the SD card on the [SD-2] slot or USB memory is selected as the current storage, the appropriate alphabetical character is added to the beginning of a file number, as shown below.

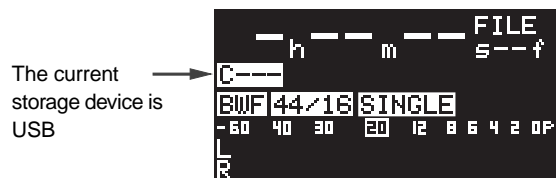
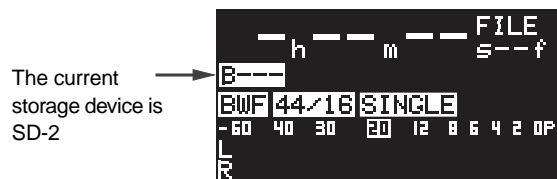

<Memo>: When the unit is turned on while the current storage device has one or more recorded files, it stops at the beginning of the first recorded file.

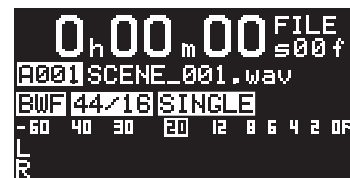

You can automatically start playback after turning on the power when a recorded storage device is inserted to the slot/port (see page 58).

When the unit is turned on while the current storage device has any folder other than the BWFF folder, the display shows the screen for selecting a folder (see pages 28 and 29).

Removing a storage device

The following shows the procedure of removing a storage device on the [SD-1] slot when the power is on. It is assumed that the unit is stopped.

<Note>: If you remove a storage device when the power is on, turn off the associated slot indicator in the following manner. If you remove a storage device when the associated slot indicator is lit, recorded data may be damaged.

<Memo>: If you remove a storage device when the power is off, no special operation is required. For an SD card, push it down and then pull it out. For a USB memory, simply pull out the memory.

- 1) Press the [EJECT READY] key. The display shows the screen below. You can see SD1 is active (i.e. selected as the current storage device).

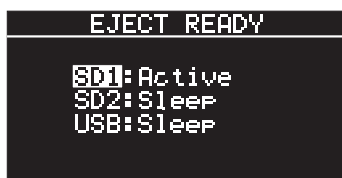
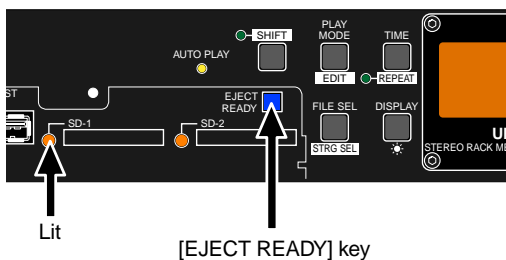

<Memo>: When SD-2 or USB memory is active, the screen shows as follows.

The current storage device is SD-2



The current storage device is USB



- 2) While "SD1" is highlighted, press the [ENTER] key. "NO" at the bottom of the screen is now highlighted.

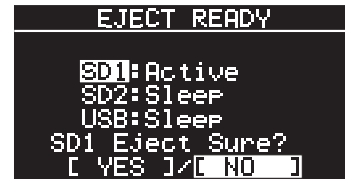

- 3) Use the [MENU] dial to highlight "[YES]" and press the [ENTER] key. The screen shows that the SD1 condition changes to "Sleep", while the SD1 indicator on the front panel turns off. You can now eject the SD card.

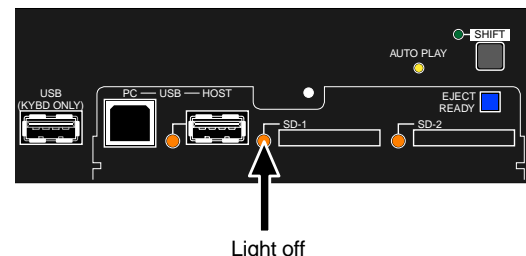
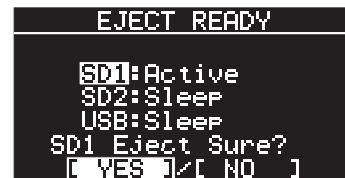

- 4) Push down the SD card set in the [SD-1] slot and then pull it out.

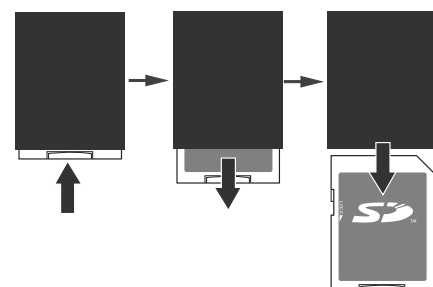

- 5) Press the [EXIT] key (or [STOP] key) to exit eject mode.

Selecting a storage device

When more than one storage device is set, you can select the desired device as the current storage. The following shows the procedure example in which the current storage device is changed from SD-1 to SD-2.

- 1) Press the **[SHIFT]** key to enter the shift mode (light up the SHIFT indicator) and press the **[FILE SEL]** / **[STRG SEL]** key.

The display now shows the storage device selection screen. For the current storage device, "Active" is shown. For another storage device, "Sleep" is shown.

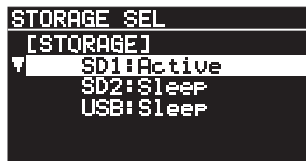
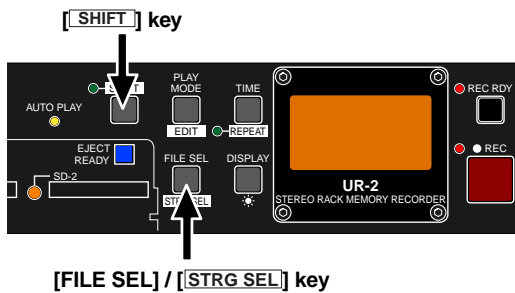

- 2) Use the **[MENU]** dial to select SD2 and press the **[ENTER]** key.

The current storage is now changed to SD2. Depending on whether the SD card in the [SD-2] slot is new or recorded, the screen looks differently (see below). In both cases, the file number starts with "B", showing that the current storage device is SD2.

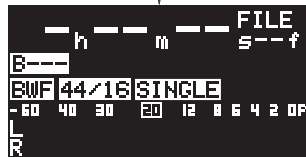
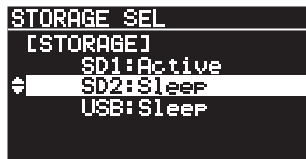

<When a new SD card is set>

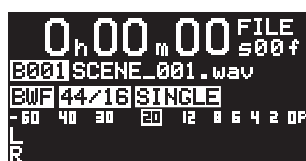

<When a recorded SD card is set>

<Note>: When you switch the current storage device from SD1 to SD2, both SD1 and SD2 indicators light in green.

This means both cards are mounted to the unit and get power from the unit even though the current storage device is switched.

You can check the current storage device by the first character of the file number.

If you press the **[SHIFT]** key followed by the **[FILE SEL]** / **[STRG SEL]** key (or if you press the **[EJECT READY]** key) in this condition, SD2 becomes "Active" while SD1 becomes "Standby".

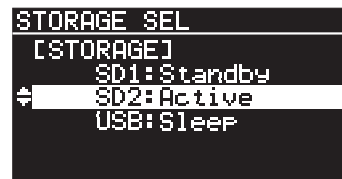

Example of the storage selection screen

<Memo>: When the unit is turned on while the current storage device has any folder other than the BFFF folder, the display shows the screen for selecting a folder, as shown below (see next page).

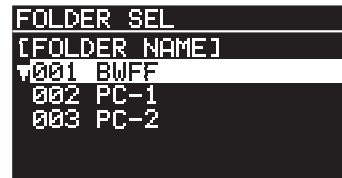

<Memo>: You can also select the current storage device by the following procedure.

- 1) While the unit is stopped, press the **[ENTER]** key to enter the MENU mode.
- 2) Use the **[MENU]** dial to select "STORAGE SEL" and press the **[ENTER]** key. The display shows the storage selection screen.

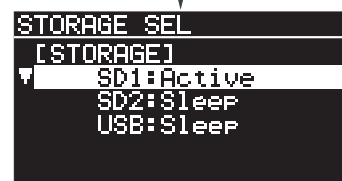
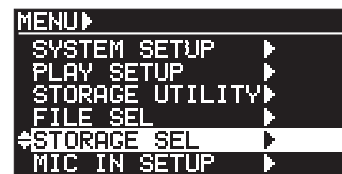

<Basic knowledge about folders and files on a storage device>

The first time you make recording to a new storage device, the "BWFF" folder is automatically created on the root (the top level folder), and a BWF file is created in the "BWFF" folder. The unit does not create more than one "BWFF" folder on a storage device. As far as you repeat recording using the unit, a created BWF file is stored in the one and only "BWFF" folder.

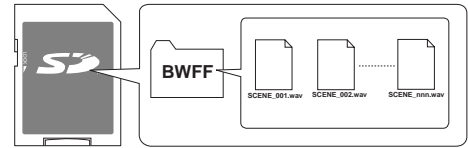

When you turn on the unit whose current storage device has only the "BWFF" folder, it locates the beginning of the first recorded file (see page 28).

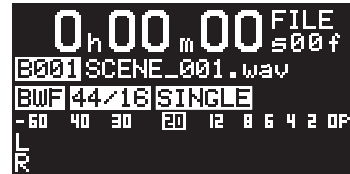

<Memo>: If you copy a folder (with BWF files) named "BWFF" from a computer to a new storage device and use it as the current storage device of the unit, then the unit locates the beginning of the first created file, as same as above. If you want to copy the BWF files stored in the "BWFF" folder from a computer to the storage device in which the "BWFF" folder already exists, copy only the files to the existing "BWFF" folder in the storage device or rename the "BWFF" folder.

You can create a folder (other than the "BWFF" folder) using a computer. The right shows the example of a storage device which has the "BWFF" folder created by the unit and two folders created by a computer.

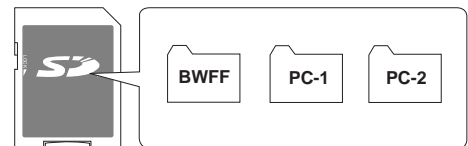

When the current storage device has more than one folder as the example in the upper right, the unit shows the folder selection screen as in the lower right.

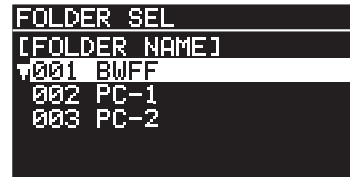

If the folder selection screen is shown, use the [MENU] dial to select a desired folder and press the [ENTER] key. You can record an audio file to the selected folder, as well as play back an audio file on the selected folder. To select another folder, press the [SHIFT] key to enter the shift mode and press the [FILE SEL] key, then use the [MENU] dial to select the active storage device and press the [ENTER] key. The folder selection screen appears and you can select the desired folder.

<Notes on copying a file from a computer>

When you copy a file from a computer, note the following (see "Copying a file from a computer" on page 65).

- (1) **When you only copy a file, copy destination must be the "BWFF" folder (or a folder created using a computer).**
If you copy a file directly to the root directory, the unit cannot recognize it.
- (2) **Name the folder using one-byte alphanumeric characters.**
- (3) **You can create folders only in the root directory.**
The subfolder cannot be recognized.

<Notes on using a storage device which has more than one folder>

When the current storage device has more than one folder, do not use the following UR-2 functions. These functions are available with a storage device which has only the "BWFF" folder.

- (1) **Power on play function** (which automatically starts playback after the unit is turned on. See page 58.)
When the unit is turned on, the folder selection screen is shown. The unit does not start playback automatically.
- (2) **Relay play mode** (which allows playback of all files on all the storage devices continuously. See page 43.)
When the unit switches the current storage device to the one which has more than one folder, the folder selection screen is shown and playback stops.

Recording

Recording system

The unit uses the FAT16 and FAT32 (FAT: File Allocation Table) file system and supports the most common BWF (Broadcast Wave File) file formats.

You can make recording in stereo (L/R) or mono. The unit uses the "1 take - 1 file" system. The first time you make recording, the "BWFF" folder is created on the root (the top level folder), and a BWF file is created in the "BWFF" folder. Regardless of FS/bit setting, all created files are stored in the same ("BWFF") folder.

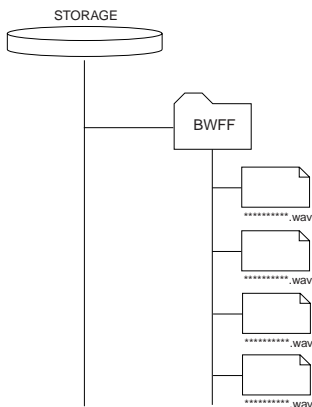

When the current storage device has any folder other than the BWFF folder, a file is created in a folder you select.

Recording time

The table below shows the approximate recording time at each recording FS/bit setting on a 1GB SD card (or a USB memory).

Recording FS/BIT	Recording channel	
	STEREO	MONO
44.1kHz/16bit	Approx. 85 min.	Approx. 170 min.
48kHz/16bit	Approx. 76 min.	Approx. 152 min.
44.1kHz/24bit	Approx. 56 min.	Approx. 112 min.
48kHz/24bit	Approx. 52 min.	Approx. 104 min.
88.2kHz/24bit	Approx. 28 min.	Approx. 56 min.
96kHz/24bit	Approx. 26 min.	Approx. 52 min.

<Memo>: You can check the recording time of the current storage device by pressing the [TIME] key in the input monitor mode (see page 34).

Setup before you start recording

Before you record signals from the analog line input, digital input or microphone input, set menu items in the "SYSTEM SETUP" and "MIC IN SETUP" menus of the MENU mode appropriately.

The following tables show the default settings of menu items in the "SYSTEM SETUP" and "MIC IN SETUP" menus. By default, you can record an analog source from the [ANALOG INPUT] connectors at 44.1 kHz/16 bit stereo to the current storage device (SD card or USB memory).

You can change the default settings if required. See the following pages for details of each menu item.

<SYSTEM SETUP menu items>

Menu item	Default
Default file name	Scene name + Take number
Recording source	Analog
Recording FS/bit	44kHz / 16bit
Recording channel	Stereo
Maximum size of an audio file	4 (GB)
Peak hold time	3 sec.
Reference level	-20dBFS

<MIC IN SETUP menu items>

Menu item	Default
MIC IN function	Enable
[MIC IN] key function	On
MIC IN function during recording	Enable
Phantom power supply	Off

SYSTEM SETUP menu item

Default file name

When you start recording, an audio file is newly created on the current device and its file name is automatically given. The file name can be set using the "Default File Name" items (see page 73).

By default, the "File Name Mode" item in the "Default File Name" item is set to "Take", therefore, the following file name is given to the first recording file.

<File Name Mode = Take (default)>

Scene Name + Take Number.wav
(Default name): SCENE_001.wav

By setting File Name Mode to "DATE", the internal clock time is added. By setting File Name Mode to "REEL", "Reel Number + File Number" is given.

<Memo>: You can change a file name later by using the "Edit File Name" item in the "STORAGE UTILITY" menu of the MENU mode (see page 83).

Recording source

Using the "Input SEL" menu item, you can select whether you record an analog source from the balanced or unbalanced [ANALOG INPUT] connectors or a digital source from the [DIGITAL INPUT] connector (see page 74).

By default, it is set to "ANALOG", therefore, you can record an analog source from the balanced or unbalanced [ANALOG INPUT] connectors.

To record a digital source from the [DIGITAL INPUT] connector, set the "Input SEL" item to "DIGITAL".

<Memo>: To record a microphone signal from the [MIC IN] connector, press the [MIC IN] key to turn on the [MIC IN] indicator (see page 34).

Sampling frequency/Quantization bit

You can set the sampling frequency and quantization bit of a recording file using the "Record FS/bit" menu item (see page 74).

By default, it is set to "44k/16" so you can record a 44.1 kHz/16 bit BWF file. To record a file of different sampling frequency or quantization bit, set this item appropriately.

When recording a digital source, set this item appropriately to match the digital input signal. If FS/bit setting does not match the input signal, the popup message "---DIF ERROR--- Illegal CS data" is shown.

<Memo>: If you start recording while FS/bit setting does not match the input signal, recording is performed with incorrect pitch.

Recording channels

You can make recording in stereo or mono by setting the "Record CH." menu item (see page 75).

By default, it is set to "STEREO" so you can make recording in stereo.

To make recording in mono, set the "Record CH." menu item to "MONO".

Maximum file size

You can set the maximum size of a recording file using the "Max File Length" menu item (see page 75).

It is recommended to set the maximum file size depending on the file size your personal computer can import.

By default, it is set to "4GB". You can also set it to "2GB".

Peak hold time

You can set the peak hold time shown on the level meter during recording using the "Peak Hold" menu item (see page 76).

By default, it is set to "3 sec". You can set it between 0 and 9 seconds in one second step.

Reference level

You can set the reference level using the "REF. Level" menu item (see page 76).

By default, it is set to "-20 dBFS". You can set it to "-12 dBFS" if required.

MIC IN SETUP menu item

In the MIC IN SETUP menu, there are menu items regarding settings of recording using an external microphone.

See also "Using an external microphone" on page 38 for actual usage.

Enabling/disabling the [MIC IN] key

Using the "MIC IN" menu item, you can select whether enabling or disabling the [MIC IN] key function (see page 39).

By default, it is set to "Enable", so you can switch on or off the microphone input using the [MIC IN] key. The "Mic Record" menu item of the MIC IN SETUP menu is set to "Enable" by default, so you can record a microphone source by pressing the [MIC IN] key to switch on the microphone input. Pressing the [MIC IN] key again switches off the microphone input and the input source selected by the "Select input" menu item becomes effective again.

During playback, pressing the [MIC IN] key mixes a microphone input source with the playback signal.

If you set the "MIC IN" menu item to "Disable", the [MIC IN] key is disabled.

[MIC IN] key function

You can select the [MIC IN] key function using the "Switch Hold" menu item (see page 39).

By default, it is set to "On". In this condition, pressing the [MIC IN] key switches on or off the microphone input.

If you set it to "Off", the microphone input is active while you press and hold down the [MIC IN] key.

Enabling/disabling [MIC IN] key during recording

You can disable the [MIC IN] key during recording using the "Mic Record" menu item (see page 40).

By default, the "Mic Record" menu item is set to "Enable". In this condition, you can record a microphone source by pressing the [MIC IN] key to switch on the microphone input.

By setting the "Mic Record" menu item is set to "Disable", you can prevent accidental switching of the recording source during recording of the line input source.

Phantom power on/off

The "Phantom" menu item allows you to switch on or off the +48 V phantom power supply to the [MIC IN] connector (see page 40).

By default, it is set to "Off".

If you make recording using a condenser microphone which requires the phantom power, set this item to "On". The phantom power is supplied to the [MIC IN] connector and the [PHANTOM] indicator above left of the [MIC IN] connector lights.

Generally the phantom power does not damage a dynamic microphone, however, do not plug in or out a dynamic microphone when the phantom power is supplied. Especially you have to pay great attention to an old ribbon microphone. (It is recommended to read the microphone manual to check the risk of damage by the phantom power.)

<Note>: Make "Phantom" On/Off setting only while a microphone is connected to the [MIC IN] connector.

<Note>: Do not unplug a microphone while the phantom power is supplied.

Basic recording

Each time you make recording, the UR-2 creates a file to the current storage device (an SD card or USB memory).

In the following operation examples, it is assumed that recording is made to a SD (SDHC) card put into the [SD-1] slot.

It is also assumed that the menu items for recording described earlier are set as default settings.

Inserting a storage device

While the unit is turned on, insert a new SD card to the [SD-1] slot.

<Memo>: If you insert more than one storage device while the unit is turned on, the first device you insert is selected as the current storage device. To change the current storage device, use the storage selection screen (see page 28).

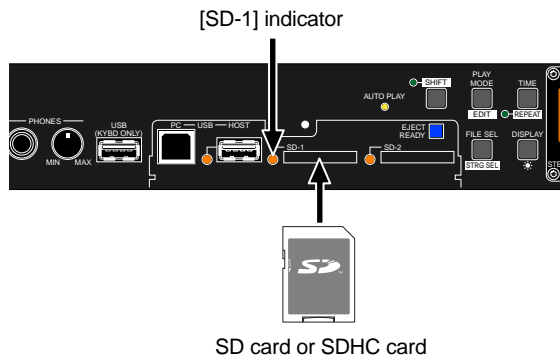

If you insert a new SD card, the unit turns on the [SD-1] indicator in green and brings up the following screen after reading the card information.

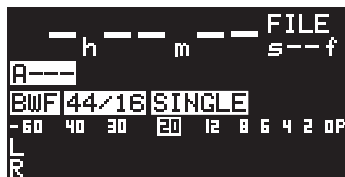

<Memo>: If you mount an SD card and then turn on the unit, the same screen as above appears.

Adjusting the recording level

You can adjust the recording level while the unit is in the input monitor mode. To enter the input monitor mode, press the [REC RDY] key to turn on the indicator.

Before recording an analog source, adjust the recording level using the [INPUT LEVEL] control. (You do not need to adjust the level when recording a digital source.)

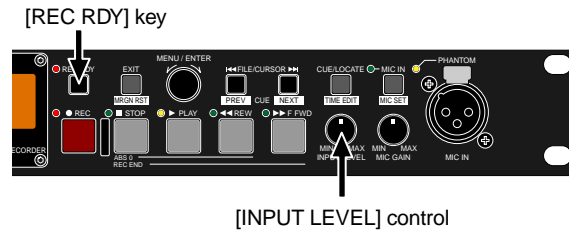

While the unit is in the input monitor mode, "NEXT" is displayed in the file name area, as well as the file name given to the next recording file (by default, "SCENE_001.wav" is displayed).

The screen also displays the file mode, FS/bit, input source and margin level.

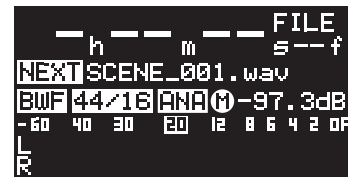

Adjust the recording level appropriately so that the "P" (peak) position of the level meter does not turn on. To get the maximum signal-to-noise performance, set the recording level appropriately so that the meter indication does not reach "P" (peak) but goes up near to "P" (peak) at the loudest part of the input signal. (When you adjust the level, the margin level value also changes.)

The center detent position of the [INPUT LEVEL] control is the reference position. That is, when the unit receives a nominal input level signal, a nominal output level signal is output.

Note that, when the "P" position is frequently lit, the sound may be distorted.

By default, the reference level is set to the "-20 dBFS" relative to digital full-scale. "20" of the onscreen meter is labeled in inverse video, showing that it is the reference position.

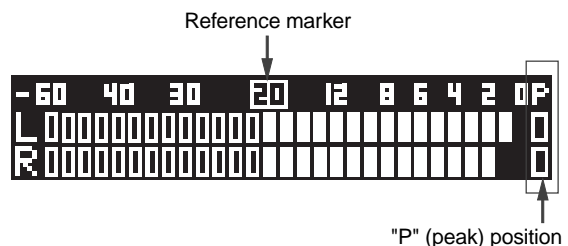

<Memo>: You can reset the margin level value by pressing the [EXIT]/[MRGN RST] key in the shift mode.

<When recording a digital source>

If you press the [REC RDY] key to enter the input monitor mode while the unit receives a correct digital signal from the [DIGITAL INPUT] connector and the "Input SEL." menu item is set to "DIGITAL", the "DIG" icon turns on. A digital signal is directly recorded to the unit at the digital signal level so you do not have to adjust the level. Note that the FS and bit length of the recording file follow the "Record FS/bit" menu item setting, so you must set this item to match the digital input signal.



<Note>: When "DIG" quickly flashes, the unit does not lock to the digital signal. In such a case, check cable connection and setting of the external digital device.

<When recording a microphone source>

By pressing the [MIC IN] key to turn on the [MIC IN] indicator, you can record a microphone source. (When [MIC IN] is active, the line input is inactive.) The microphone input level can be adjusted using the [MIC GAIN] control. You can record a microphone source, as well as record a narration between songs.

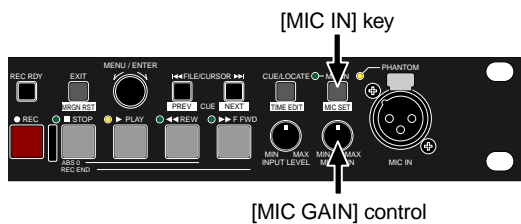

When [MIC IN] is active, the display shows "MIC" instead of "ANA" (or "DIG"). If you switch to [MIC IN] when "Digital" is selected, the microphone source is recorded with reference to the digital clock of the digital input signal.

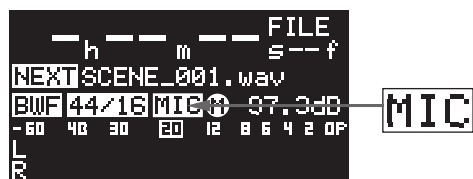

Checking the remaining time

Before you start recording, it is recommended to check the remaining recording time of the current storage.

By pressing the [TIME]/[REPEAT] key in the input monitor mode, the screen changes from time display to remaining display. (Each press of the key switches between these displays.)

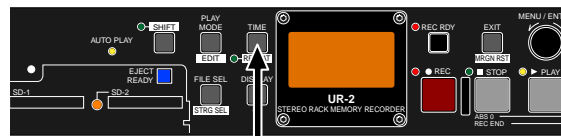

[TIME] / [REPEAT] key

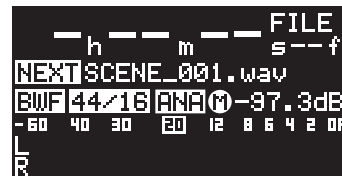

<Time display>

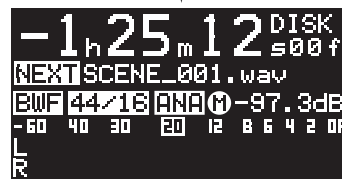

<Remaining display>

The screen above shows that the current storage device has a space for recording 1 hour 25 minutes 12 seconds of a stereo file at 44.1 kHz/16 bit.

Starting recording

While the unit is in the input monitor mode, press the [REC] key to start recording. The [REC RDY] indicator changes from flashing to lighting, while the [REC] indicator lights.

When you start recording for the first time, the unit creates the "BWF" folder, in which the recorded files are stored. Each time you make recording, a new file is created. (You cannot overwrite an existing file.)

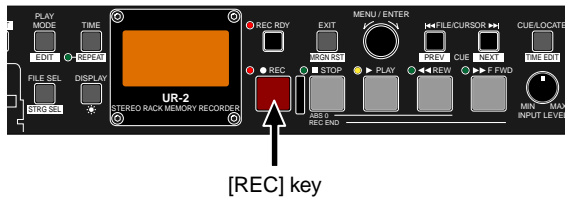

After recording starts, the display changes as follows.

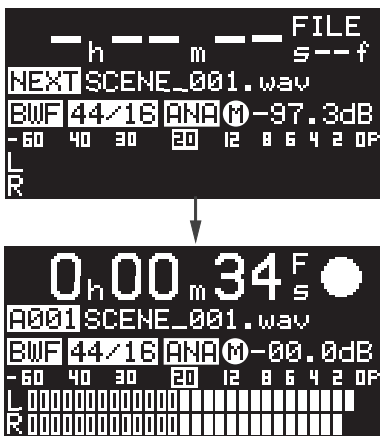

To stop recording, press the [STOP] key.
To exit the input monitor mode, press the [REC RDY] key.

<Memo>: With the default settings, each time you make recording, the unit creates a file with the file name including the counted-up take number, as follows.

(Example): SCENE_001.wav, SCENE_002.wav

<Memo>: To play back the recorded audio file after recording, press the [REW] key while holding down the [STOP] key to skip to the beginning of the file, and press the [PLAY] key. To select a desired file from multiple files, use the [◀◀] and [▶▶] keys or use the file selection screen (see page 42).

Setting a CUE point

You can set a CUE point at the desired position of a file by using two methods described below. A CUE point can be used as a marker which you can easily skip to, as well as used as the start or end point of a file in the chain play list or timer play list.

- 1) While recording an audio signal, you can set a CUE point on-the-fly at the desired position.
- 2) Using the CUE list screen, you can set a CUE point.

Setting a CUE point on-the-fly during recording

By pressing the [CUE/LOCATE] key at the desired position during recording, a new CUE point is set. You can set up to 99 CUE points for each file.

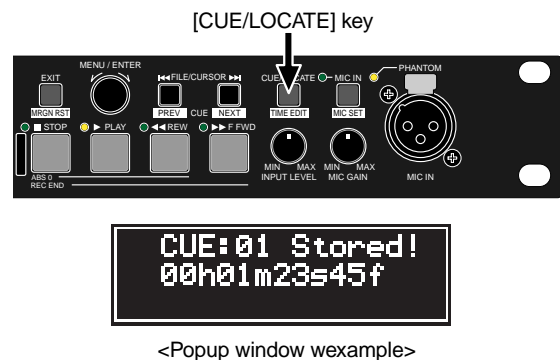

When you set a CUE point on-the-fly, the popup window as above briefly appears. Each time you set a CUE point, the CUE number is counted up by one.

Viewing CUE points

Pressing the [CUE/LOCATE] key while the unit is stopped brings up the CUE LIST screen, on which you can view the existing CUE points.

In the following example, CUE 01 through CUE 04 are set.

A CUE label is automatically set. CUE labels for CUE01 and CUE02 are "BC\$START" and "BC\$END" respectively, which are reserved by the BWF-J specifications.



<Memo>: By selecting the desired CUE on the CUE LIST screen and pressing the [CUE/LOCATE] key, you can skip to the CUE point.

Editing a CUE point

By selecting the desired CUE on the CUE LIST screen and pressing the [ENTER] key, you can bring up the CUE editing screen. By default, "Label" flashes.

On this screen, you can edit a CUE label and CUE position, as well as delete a CUE.

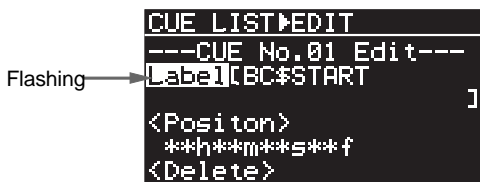

• Editing a CUE label

By pressing the [ENTER] key while "Label" flashes, the first character of the current label starts flashing and you can now edit it.

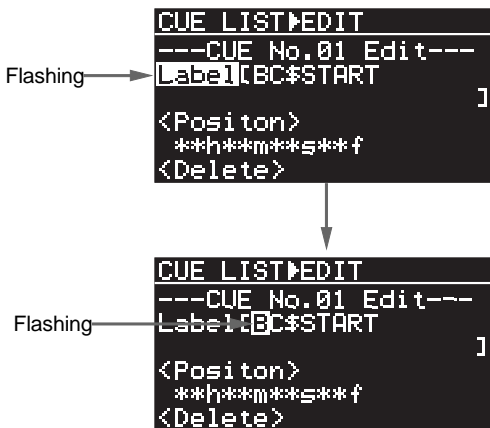

Use the [◀◀] and [▶▶] key to move the editing position and use the [MENU] dial to select a character. After you finish editing, press the [ENTER] key to confirm the editing. (You can also edit a label using the USB keyboard.)

• Editing CUE time data

By using the [MENU] dial to highlight "<Position>" and pressing the [ENTER] key, the frame digit of CUE point time data starts flashing and you can now edit it.

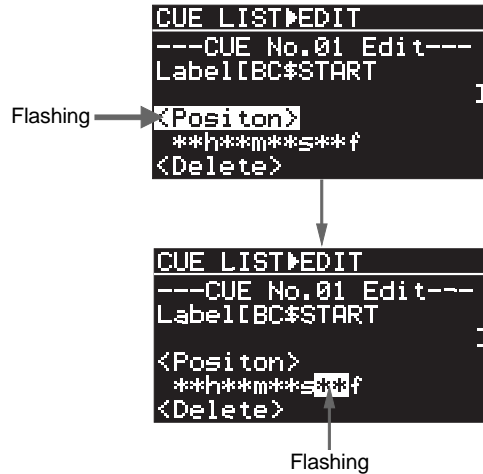

Use the [◀◀] and [▶▶] key to move the editing position and use the [MENU] dial to select a value. After you finish editing, press the [ENTER] key to confirm the editing. (You can also edit a label using the USB keyboard.)

<Note>: If you enter an illegal time value and press the [ENTER] key, the display briefly shows "Illegal Time!" and cancels editing.

<Memo>: After entering a new time data, pressing the [CUE/LOCATE] key locates the unit to the new CUE point.

• Deleting a CUE point

By using the [MENU] dial to highlight "<Delete>" at the bottom of the display and pressing the [ENTER] key, "Sure?" starts flashing.

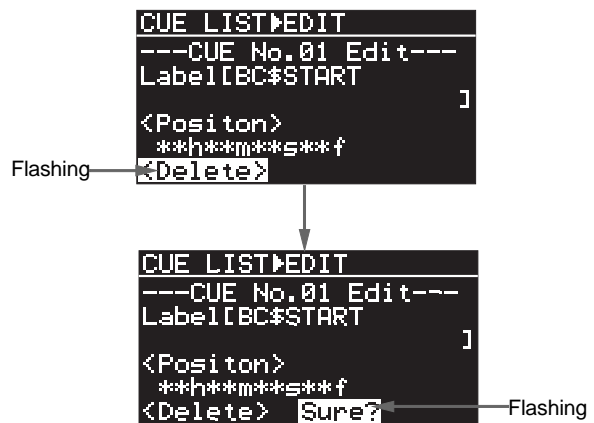

Pressing the [ENTER] key again deletes the selected CUE point from the list.

<Memo>: In the CUE number of the CUE LIST screen where the CUE point has been deleted, no CUE label is shown and the time data shows "--h--m--".

• Setting a new CUE point using the CUE LIST screen

While the CUE LIST screen is shown, you can add a new CUE point.

Use the [MENU] dial to highlight a CUE number where no CUE point is set in the CUE LIST ("CUE 05" in the screen example below), and press the [ENTER] key.

The time data of the current position when you press the [ENTER] key is stored as CUE 05.

The image shows two screenshots of the CUE LIST screen, connected by a downward arrow. The top screenshot shows the CUE LIST screen with the following data:

CUE	Label	Time Data
01	BC\$START	**h**m**
02	BC\$END	**h**m**
03	CUE03	**h**m**
04	CUE04	**h**m**
05		--h--m--
06		--h--m--

The bottom screenshot shows the CUE LIST screen after a new cue point has been added:

CUE	Label	Time Data
01	BC\$START	**h**m**
02	BC\$END	**h**m**
03	CUE03	**h**m**
04	CUE04	**h**m**
05	CUE05	**h**m**
06		--h--m--

By pressing the [STOP] key (or [EXIT] key repeatedly), you can exit CUE editing mode.

Using an external microphone

By connecting an external microphone to the [MIC IN] connector on the front panel, you can use the microphone for recording as well as during playback.

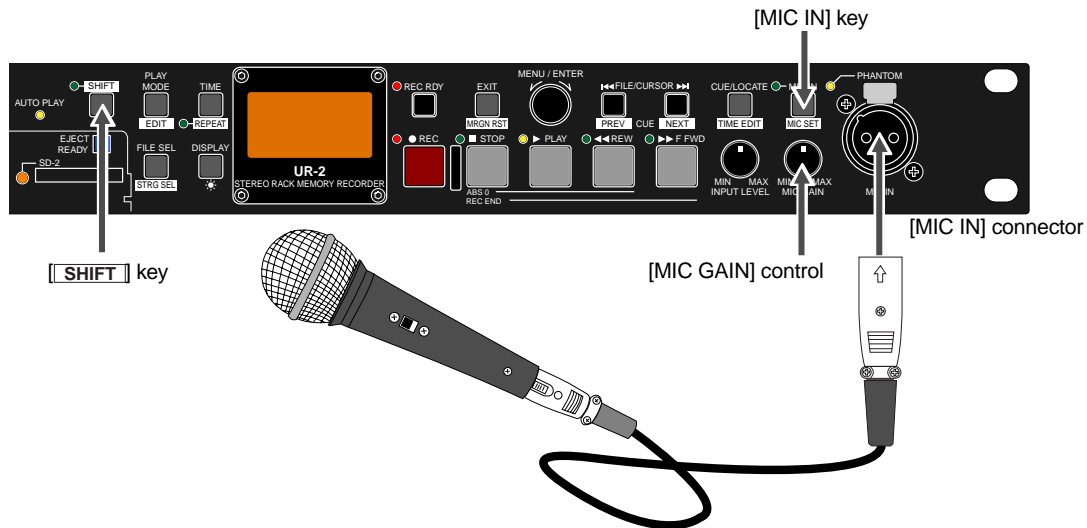

With the default setting, pressing the [MIC IN] key beside the [MIC IN] connector to turn on the [MIC IN] indicator enables the external microphone input. The microphone level can be adjusted by the [MIC GAIN] control.

In the "MIC IN SETUP" menu of the MENU mode, there are setting items for using an external microphone, such as phantom power setting. Set these items appropriately to match your requirement. (See the following pages for details about the "MIC IN SETUP" menu items).

Using a microphone for recording

- You can record only a microphone signal.
- You can record a microphone signal breaking into analog line or digital source recording.
During analog line or digital source recording, pressing the [MIC IN] key switches the recording source to the microphone input signal. Therefore, you can record a microphone signal breaking into the audio source. (Using this function, you can insert a narration between songs.)

In order not to accidentally switch to the microphone input during analog line or digital source recording, you can disable the [MIC IN] key function or disable microphone recording using the appropriate menu items in the "MIC IN SETUP" menu described in the following pages.

Using a microphone during playback

- You can output a microphone signal mixed with the file playback sound.
When you mix a microphone signal with the file playback sound, you can attenuate or mute the playback sound using the "Play ATT." menu item in the "MIC IN SETUP" menu described later.
- You can use only a microphone for announce, etc.

Settings the MIC IN SETUP menu

Before using an external microphone, set the items in the "MIC IN SETUP" menu of the MENU mode appropriately to match your requirement.

- Press the **[SHIFT]** key to turn on the **[SHIFT]** indicator, followed by the **[MIC IN]/[MIC SET]** key. The display shows the screen for selecting the MIC IN SETUP menu item.

```

M>MIC>
Mic in      :Enable
Switch hold :On
Play ATT.   :-6dB
Mic record  :Enable
Phantom     :Off
    
```

<Memo>: You can also bring up the screen for selecting the MIC IN SETUP menu item by the following procedure.

- While the unit is stopped, press the **[ENTER]** key to enter the MENU mode.
- Use the **[MENU]** dial to highlight "MIC IN SETUP" and press the **[ENTER]** key.

```

MENU>
FILE SEL  >
STORAGE SEL >
MIC IN SETUP >
CHAIN PLAY SET >
TIMER PLAY SET >
REMOTE SET >
    
```

↓

```

M>MIC>
Mic in      :Enable
Switch hold :On
Play ATT.   :-6dB
Mic record  :Enable
Phantom     :Off
    
```

- Use the **[MENU]** dial to highlight the desired menu item and press the **[ENTER]** key. The current setting start flashing. You can now change the setting.

```

M>MIC>Mic in
Mic in      :Enable
Switch hold :On
Play ATT.   :-6dB
Mic record  :Enable
Phantom     :Off
    
```

Flashing

- Use the **[MENU]** dial to select the desired option and press the **[ENTER]** key to confirm your selection.

In the screen example, "Disable" is selected for the "Mic In" item.

```

M>MIC>
Mic in      :Disable
Switch hold :On
Play ATT.   :-6dB
Mic record  :Enable
Phantom     :Off
    
```

Make setting for other menu items in a similar manner.

After you finish all settings you want to change, press the **[STOP]** key (or press the **[EXIT]** key repeatedly) to exit the MENU mode. For details about each menu item, see the following.

Enabling/disabling the [MIC IN] key

Using the "MIC IN" menu item, you can select whether enabling or disabling the **[MIC IN]** key function (see page 38).

Enable (default)	Pressing the [MIC IN] key switch on or off the microphone input. When the microphone input is active, the [MIC IN] indicator lights. When inactive, the indicator is unlit.
Disable	The [MIC IN] key does not work.

<Memo>: If you press the **[MIC IN]** key when this item is set to Disable, the following popup window appears.

```
Disable Mic in
```

[MIC IN] key function

Using the "Switch Hold" menu item, you can select the **[MIC IN]** key function (toggle or momentary).

On (default)	The [MIC IN] key functions as a toggle key. Each press of the key switches on or off the microphone input.
Off	The [MIC IN] key functions as a momentary key. The microphone input is active while pressing down the [MIC IN] key.

Attenuating playback level

Using the [Play ATT] menu item, you can set attenuation level of the audio file playback sound when you mix the microphone signal to the audio file playback. This setting does not affect the microphone level.

0dB	The playback sound is not attenuated. The audio file is played back at the recorded level.
-6dB (default)	The playback sound is attenuated by 6 dB.
-12dB	The playback sound is attenuated by 12 dB.
- ∞	The playback sound is muted.

Enabling/disabling [MIC IN] key during recording

Using the "Mic Record" menu item, you can disable or enable the [MIC IN] key during recording (or in the input monitor mode).

Enable (default)	You can record a microphone source by pressing the [MIC IN] key to switch on the microphone input.
Disable	Pressing the [MIC IN] key does not change the input source during recording.

<Note>: You can switch from the analog input to the microphone input, as well as from the digital input to the microphone input. In the latter case, the microphone input source is recorded with reference to the digital input clock.

<Note>: Even though the "MIC IN" menu item is set to "Enable", you cannot record a microphone input source when the "Mic Record" menu item is set to "Disable". (Note that however, you can use the microphone input during playback or while stopped.)

Even though the "Mic Record" menu item is set to "Enable", you cannot record a microphone input source when the "MIC IN" menu item is set to "Disable".

If you press the [MIC IN] key during recording or in the input monitor mode, the following popup window appears.

```
Disable
Mic in record
_
```

```
Disable Mic in
```

Phantom power on/off

Using the "Phantom" menu item, you can switch on or off the phantom power supply to the [MIC IN] connector.

Generally the phantom power does not damage a dynamic microphone, however, do not plug in or out a dynamic microphone when the phantom power is supplied. Especially you have to pay great attention to an old ribbon microphone. (It is recommended to read the microphone manual to check the risk of damage by the phantom power.)

Off (default)	The phantom power is not supplied.
On	The phantom power is supplied to the [MIC IN] connector and the [PHANTOM] indicator lights.

<Note>: Make "Phantom" On/Off setting only while a microphone is connected to the [MIC IN] key.

<Note>: Do not unplug a microphone while the phantom power is supplied.

Playback

Play mode

The UR-2 has seven play modes. You can switch the play mode in the following order by pressing the [PLAY MODE] key.

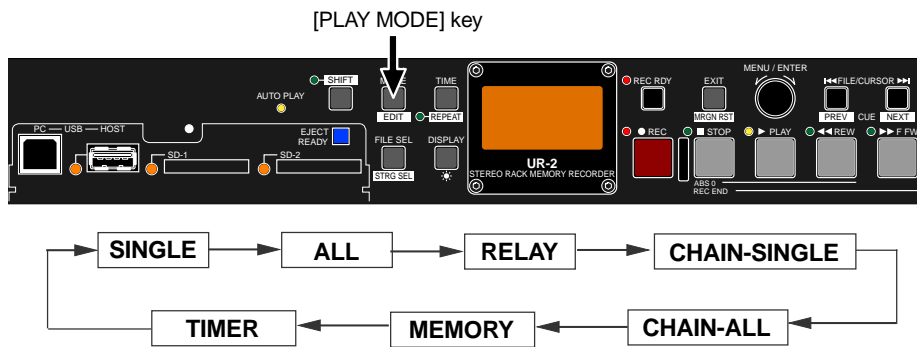

SINGLE play mode	The unit plays back a selected file on the current storage device. The default play mode is the SINGLE mode (see the next page).
ALL play mode	The unit plays back all files on the current storage device continuously in the recording order (see page 43).
RELAY play mode	You can select this mode when more than one storage device is set. The unit plays back all files on all the storage devices continuously (see page 43).
CHAIN-SINGLE play mode	You can select this mode when the chain play list is created on the current storage device. The unit plays back a selected file on the chain play list (see page 44).
CHAIN-ALL play mode	You can select this mode when the chain play list is created on the current storage device. The unit plays back all files on the chain play list (see page 44).
MEMORY play mode	You can select this mode when the chain play list is created on the current storage device. The memory data assigned to the numeric keys (0 through 9) on a USB keyboard connected to the unit is played back with instant start (see page 45).
TIMER play mode	At the selected time, the unit automatically starts playback of a selected file (page 45).

<Memo>: In addition to the method using the [PLAY MODE] key, you can also select the play mode using the "Play Mode" menu item in the PLAY SETUP menu of the MENU mode (see page 56).

<Memo>: The unit provides the following playback functions.

- (1) **Repeat function (plays back repeatedly).** See page 54.
- (2) **Auto play function (automatically starts playback after skipping to or locating a position).** See page 54.
- (3) **Power-on play function (automatically starts playback after the unit is powered on).** See page 55.
- (4) **Cueing function (moves fast while playing back audio).** See page 54.
- (5) **Digital scrub function (scrubs audio digitally).** See page 55.

Playback in SINGLE play mode

When you select the SINGLE play mode, "SINGLE" lights on the display. (By default, the SINGLE play mode is selected.)

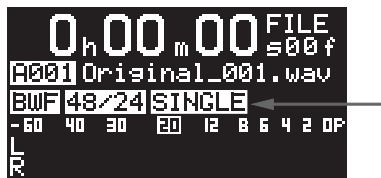

In the SINGLE play mode, the unit plays back a current file only. After finishing playback, the unit stops at the beginning of the file.

To play back a different file, select a desired file using either of the methods described below.

<Memo>: By activating the repeat function, you can play back a file repeatedly until you stop by pressing the [STOP] key (see page 54).

<Memo>: You can mix a microphone source while playing back a file. By pressing the [MIC IN] key, the unit accepts the microphone signal from the [MIC IN] connector. You can adjust the microphone level using the [MIC GAIN] control.

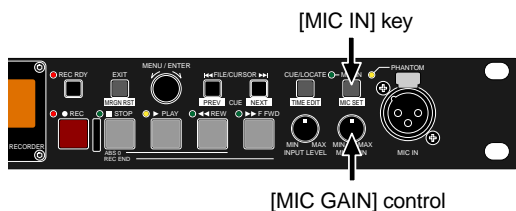

You can mix the microphone signal with the file playback sound. You can also output the microphone signal alone while the unit is stopped. When you mix the microphone signal with the file playback sound, the file playback sound is attenuated by 6 dB by default. For the details about settings for microphone usage, see "Using an external microphone" on page 38.

Selecting a playback file

• Using the [◀◀] and [▶▶] keys

While the unit is stopped, pressing the [◀◀] or [▶▶] key skips to the beginning of the previous or next file. Therefore, you can select a desired file by pressing the appropriate [◀◀] or [▶▶] key as many times as required.

• Using the file selection screen

- (1) While the unit is stopped, press the [FILE SEL] key.

The display shows the file selection screen on which recorded files are listed.



- (2) Use the [MENU] dial to select a desired file and press the [ENTER] key.

The display now shows the Home screen for the selected file.

<Memo>: You can also bring up the file selection screen above by the following procedure.

- 1) While the unit is stopped, press the [ENTER] key to enter the MENU mode.



- 2) Use the [MENU] dial to select "FILE SEL" and press the [ENTER] key.

The display shows the file selection screen.

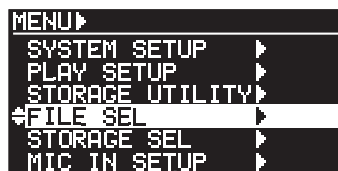

Playback in ALL play mode

When you select the ALL play mode, "ALL" lights on the display.

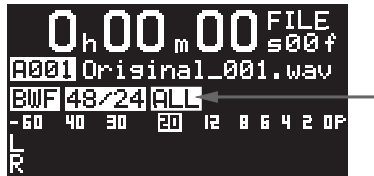

In the ALL play mode, the unit continuously plays back all files on the current storage device in recording order. (If you want to play back files randomly, use the CHAIN ALL play mode described later.)

When finishing playback of the last file, the unit stops at the finishing position.

Normally the unit plays back files on the current storage device in the recording order. However, using the [◀◀] or [▶▶] key or from the file selection screen, you can select a desired file to be played back (see page 42).

<Note>: If you select a file from which playback starts, the files created earlier than the selected file are not played back. For example, if you select the "005" file when the current storage device has ten files from "001" through "010", files 005 through 010 are played back but files 001 through 004 are not played back.

<Note>: If you copy files recorded using a computer to an SD card and set the SD card to the UR-2, the unit basically plays back files on the card in the order of file copying to the card. However, a file whose file name has been edited by a computer may be played back at the last.

<Memo>: By activating the repeat function, you can play back files repeatedly until you stop by pressing the [STOP] key (see page 54).

<Memo>: The unit plays back file in the recording order. Even if you edit a file name, the playback order does not change.

<Memo>: When playing back a file, you can mix a microphone signal and output the mixed signal (see page 38).

Playback in RELAY play mode

When you select the RELAY play mode, "RELAY" lights on the display.

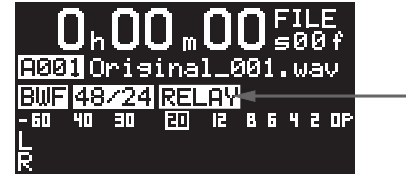

In the RELAY play mode, the unit continuously plays back all files on the current storage device, and switches the current storage device, then continuously plays back all files on the next current storage device.

<Note>: When two storage devices are set, if you select the RELAY play mode and then remove one of the storage devices, the unit cancels the RELAY play mode and enters the ALL play mode.

<Memo>: The current storage device changes in the following order.

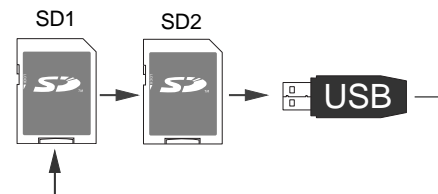

<Note>: When the unit switches the current storage device, it takes some time for loading so there is a silent space of a few seconds.

<Note>: When more than one folder exists on the current storage device, after the unit finishes playback of the last file of the current folder, it switches the current storage device to the next one.

<Note>: When the unit switches the storage device to the next one which has more than one folder, the unit brings up the folder selection screen and stops (see page 29).

Playback in CHAIN SINGLE play mode

When you select the CHAIN SINGLE play mode, "CHAIN SINGLE" lights on the display, while the unit reads the chain play list information and stops at the beginning of the first file in the list.

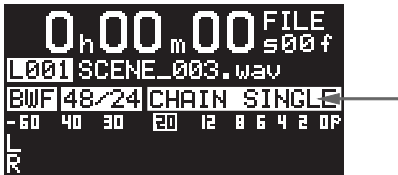

<Note>: When no chain play list is created, "CHAIN LIST Empty!" is briefly shown followed by the following screen. In this case, create the chain play list and select the CHAIN SINGLE play mode again. See page 46 for details about how to create the chain play list.



In the CHAIN SINGLE play mode, the unit plays back a selected file in the chain play list. After finishing playback, the unit stops at the beginning of the next file. To play back a different file, select a desired file using the [◀◀] or [▶▶] key, or using the file selection screen (see page 42).

<Memo>: By activating the repeat function, you can play back a file repeatedly until you stop by pressing the [STOP] key (see page 54).

<Memo>: You can mix a microphone source while playing back a file. You can also output the microphone signal alone while the unit is stopped. (See page 38.)

Playback in CHAIN ALL play mode

When you select the CHAIN ALL play mode, "CHAIN ALL" lights on the display, while the unit reads the chain play list information and stops at the beginning of the first file in the list.

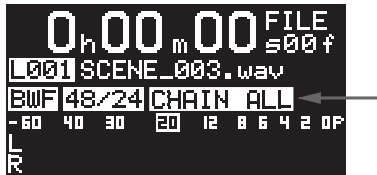

<Note>: When no chain play list is created, "CHAIN LIST Empty!" is briefly shown followed by the following screen. In this case, create the chain play list and select the CHAIN ALL play mode again. See page 46 for details about how to create the chain play list.



In the CHAIN ALL play mode, the unit continuously plays back all files in the chain play list from the first file. After finishing playback of the last file in the chain play list, the unit stops at the beginning of the first file. To start playback from a desired file, select the file using the [◀◀] or [▶▶] key, or using the file selection screen (see page 42).

<Note>: When the unit switches the playback file, if the next file has different FS/bit, it takes some time to switch the file. Therefore, there is a silent space between files.

<Memo>: You can mix a microphone source while playing back a file. You can also output the microphone signal alone while the unit is stopped. (See page 38.)

<Memo>: By activating the repeat function, you can play back a file repeatedly until you stop by pressing the [STOP] key (see page 54).

Playback in MEMORY play mode

When you select the MEMORY play mode, the unit reads the play list information and shows the MEMORY PLAY MODE screen as below.



<Note>: If the list is not created, "CHAIN LIST Empty!" is shown followed by the screen as below. In such a case, create the play list and then select the MEMORY play mode again (see page 46 for details about how to create the play list).

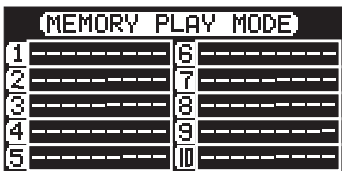

In the MEMORY play mode, you can perform instant start of up to ten files in the play list from a USB keyboard.

The memory numbers 1 through 10 in the MEMORY PLAY MODE screen are assigned to the numeric keys on the keyboard. Pressing a numeric key starts playback of the file set to the corresponding memory number. Memory number 10 is assigned to the "0" key.

For example, if you press the "4" key of the USB keyboard, the file set to memory number 4 starts playback instantly and the display shows the screen as below. At the top of the screen, the playback elapsed time is shown.

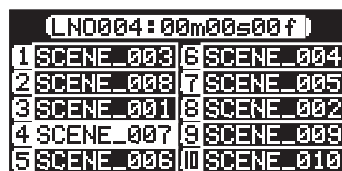

<Note>: Unlike other play modes, the repeat function cannot be active in the MEMORY play mode.

Playback in TIMER play mode

When you select the TIMER play mode, the unit reads the play list information and shows the timer play screen something like below.

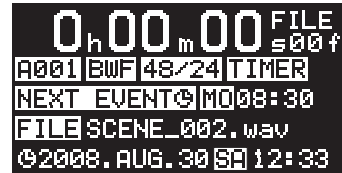

<Note>: If the list is not created, "TIMER LIST Empty!" is shown followed by the screen as below. In such a case, create the play list and then select the TIMER play mode again (see page 51 for details about how to create the play list).



In the TIMER play mode, the unit starts playback of the files in the list. You may use this mode for ringing the chimes at the fixed time.

<Note>: The timer play is referenced to the internal realtime clock information. So you should adjust the realtime clock correctly. For details about how to adjust the realtime clock, see page 23.

<Memo>: While the timer play screen as above is shown, you can preview the file to be played back by pressing the [PLAY] key.

Creating the chain play list

To execute the CHAIN SINGLE, CHAIN ALL or MEMORY play, the chain play list must be created.

The created chain play list is stored in the current folder in the current storage device. In the following procedure, it is assumed that the folder in which you make the chain play list is open and files are stored in the folder.

<Memo>: You can set up to 250 files on the chain play list.
The files set in the list numbers from 001 to 010 are used for the MEMORY play.

- (1) While the unit is stopped, press the [ENTER] key to enter the MENU mode.
- (2) Use the [MENU] dial to highlight "CHAIN PLAY SET" and press the [ENTER] key.
The display shows the screen for selecting the list number. In the screen, the following items are shown.

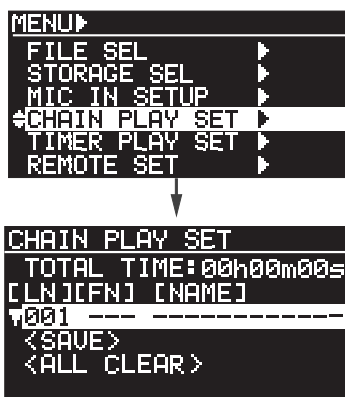

TOTAL TIME	The total time of files set in the list.
[LN]	The list number is shown below.
[FN] [NAME]	The file number and name of a file which is set.
<SAVE>	When you save the list created, select this item.
<ALL CLEAR>	When you clear the list created, select this item.

- (3) While "001" is highlighted, press the [ENTER] key.
You can now select a file you want to set to list number 001.

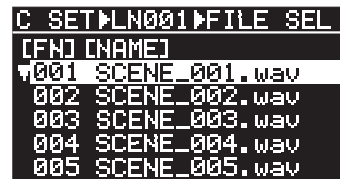

- (4) Use the [MENU] dial to highlight a desired file and press the [ENTER] key.
If you select file 003, it is set to list number 001, and the display again shows the screen for selecting the list number.



- (5) Use the [MENU] dial to highlight "002" and press the [ENTER] key.
You can now select a file you want to set to list number 002.

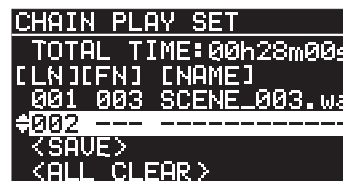

- (6) Use the [MENU] dial to highlight a desired file and press the [ENTER] key.
The selected file is set to list number 002, and the display again shows the screen for selecting the list number.
- (7) Repeat the steps (5) and (6) above to set files as many times as required.
In the screen example below, files are set from list number 001 to list number 010.



<Memo>: When you set a file to the list, all audio data (from ABS 0 to REC END) is set as the playback area. However, you can specify the start and (or) end points if required (see the next section, "Editing the list").

<Memo>: By using the [MENU] dial to highlight "<ALL CLEAR>" at the bottom of the screen and pressing the [ENTER] key, all the files in the list are cleared and the screen returns to the initial condition before you set files.

```
CHAIN PLAY SET
TOTAL TIME:01h28m00s
[LN][FN] [NAME]
010 010 SCENE_010.wa
011 -----
<SAVE>
<ALL CLEAR>
```

↓

```
CHAIN PLAY SET
TOTAL TIME:00h00m00s
[LN][FN] [NAME]
001 -----
<SAVE>
<ALL CLEAR>
```

- (8) Use the [MENU] dial to highlight "<SAVE>" and press the [ENTER] key. The display changes to show the screen for saving the play list named "CHAINLIST.CSV", on which "?" flashes.

```
CHAIN PLAY SET
TOTAL TIME:01h28m00s
[LN][FN] [NAME]
010 010 SCENE_010.wa
011 -----
* <SAVE>
<ALL CLEAR>
```

↓

```
CHAIN PLAY SET>SAVE
-Chain play list---
List save
[CHAINLIST.CSV ]
Are you sure?
Yes:[ENTER] key
No:[EXIT] key
```

- (9) Press the [ENTER] key to save the list. After the unit finishes saving the list, the display returns to the Home screen.

<Memo>: The play list is saved to the folder in the current storage device as the "CHAINLIST.CSV" file in the CSV (Comma Separated Value) format. (The list is overwritten.) See page 88.

Editing the chain play list

You can edit the chain play list. The following editing items are available.

- 1) Editing the start and end points of a file using the time edit function.
- 2) Replacing the start or end point with a CUE time.
- 3) Fine-adjusting the start or end point using the digital scrub function.
- 4) Inserting a file to the chain play list.
- 5) Deleting a file from the chain play list.

In the following description, it is assumed that the chain play list as the table below is created.

List number	File number	File name
001	003	SCENE_003
002	008	SCENE_008
003	001	SCENE_001
004	007	SCENE_007
005	006	SCENE_006
006	004	SCENE_004
007	005	SCENE_005
008	002	SCENE_002
009	009	SCENE_009
010	010	SCENE_010

Editing a point using the time edit function

The following description shows the procedure example of editing the start and end points of file number 008 which is set to list number 002 using the time edit function.

- 1) While the unit is stopped, press the [ENTER] key to enter the MENU mode.
- 2) Use the [MENU] dial to highlight "CHAIN PLAY SET" and press the [ENTER] key. The chain play list is shown.

```
CHAIN PLAY SET
TOTAL TIME:01h28m00s
[LN][FN] [NAME]
001 003 SCENE_003.wa
002 008 SCENE_008.wa
003 001 SCENE_001.wa
004 007 SCENE_007.wa
```

- (3) Use the [MENU] dial to highlight LN (list number) "002" and press the [ENTER] key. The start and end points of the "008" file set to list number 002 are shown.

```
CHAIN PLAY SET▶LN002
[FNO]008
[NAME]SCENE_008.wav
[START]00h00m00s00f
[END] 00h28m21s20f
<SCRUB-S> <SCRUB-E>
<SAVE> <DEL> <INS>
```

By default, the start time is set to the beginning of the file (ABS 0) while the stop time is set to the last recording time (REC END).

- (4) To edit the start time, press the [ENTER] key while "[START]" is highlighted. To edit the stop time, use the [MENU] dial to highlight "[END]" and press the [ENTER] key. On the screen, the frame digit of the start or stop time flashes, as show below.

```
CHAIN PLAY SET▶LN002
[FNO]008
[NAME]SCENE_008.wav
[START]00h00m00s00f
[END] 00h28m21s20f
<SCRUB-S> <SCRUB-E>
<SAVE> <DEL> <INS>
```

```
CHAIN PLAY SET▶LN002
[FNO]008
[NAME]SCENE_008.wav
[START]00h00m00s00f
[END] 00h28m21s20f
<SCRUB-S> <SCRUB-E>
<SAVE> <DEL> <INS>
```

Flashing

<When selecting "[START]">

```
CHAIN PLAY SET▶LN002
[FNO]008
[NAME]SCENE_008.wav
[START]00h00m00s00f
[END] 00h28m21s20f
<SCRUB-S> <SCRUB-E>
<SAVE> <DEL> <INS>
```

```
CHAIN PLAY SET▶LN002
[FNO]008
[NAME]SCENE_008.wav
[START]00h00m00s00f
[END] 00h28m21s20f
<SCRUB-S> <SCRUB-E>
<SAVE> <DEL> <INS>
```

Flashing

<When selecting "[END]">

- (5) Edit the start or stop time. Use the [MENU] dial to edit the value at the flashing point. Use the [◀◀] and [▶▶] keys to select the flashing point.
- (6) After you complete editing, use the [MENU] dial to highlight "<SAVE>" and press the [ENTER] key. The edited start and end points are set and the display returns to the chain play list screen.

```
CHAIN PLAY SET▶LN002
[FNO]008
[NAME]SCENE_008.wav
[START]00h00m30s00f
[END] 00h20m00s00f
<SCRUB-S> <SCRUB-E>
<SAVE> <DEL> <INS>
```

```
CHAIN PLAY SET
TOTAL TIME: 01h28m00s
[LN][FN] [NAME]
001 003 SCENE_003.wa
▶002 008 SCENE_008.wa
003 001 SCENE_001.wa
004 007 SCENE_007.wa
```

Replacing a point with CUE time

You can replace the current start (or end) time with a CUE time.

<Note>: To execute the following operation, more than one CUE point must be set to the file to be edited. Without any CUE point, you cannot execute the following operation. If you replace the start (or end) time with a CUE time and then edit the CUE time, the replaced start (or end) time is not affected.

- (1) Use the [MENU] dial to highlight "[START]" or "[END]" and press the [CUE/LOCATE] key. The CUE list is shown.

```
CHAIN PLAY SET▶LN002
[FNO]008
[NAME]SCENE_008.wav
[START]00h00m00s00f
[END] 00h28m21s20f
<SCRUB-S> <SCRUB-E>
<SAVE> <DEL> <INS>
```

```
CHAIN▶START SEL▶CUE
01 BC#START  **h***m**
02 BC#END   **h***m**
03 Cue 03   **h***m**
04 Cue 04   **h***m**
05 Cue 05   **h***m**
06 Cue 06   **h***m**
```

<CUE list screen when selecting "[START]">

```
CHAIN PLAY SET▶LN002
[FNO]008
[NAME]SCENE_008.wav
[START]00h00m00s00f
[END] 00h28m21s20f
<SCRUB-S> <SCRUB-E>
<SAVE> <DEL> <INS>
```

```
CHAIN▶END SEL▶CUE
01 BC#START **h**m**s**
02 BC#END **h**m**s**
03 Cue 03 **h**m**s**
04 Cue 04 **h**m**s**
05 Cue 05 **h**m**s**
06 Cue 06 **h**m**s**
```

<CUE list screen when selecting "[END]">

```
CHAIN PLAY SET▶LN001
[FNO]001
[NAME]Original.wav
[START]00h00m00s00f
[END] 00h48m52s12f
<SCRUB-S> <SCRUB-E>
<ADD> <CLEAR>
```



<Scrub screen for the end time>

- (2) Use the [MENU] dial to highlight the desired CUE and press the [ENTER] key.
The CUE time is set to the start (or stop) time.
- (3) After you complete editing, use the [MENU] dial to highlight "<SAVE>" and press the [ENTER] key.
The display returns to the chain play list screen.

- (2) Use the [MENU] dial to scrub audio for fine-adjusting the point.
The unit plays back audio for 30 milliseconds around the start point (or end point) repeatedly.
- (3) After adjusting the point, press the [ENTER] key.
The adjusted point is set.
- (4) After you complete editing, use the [MENU] dial to highlight "<SAVE>" and press the [ENTER] key.
The display returns to the chain play list screen.

Fine-adjusting using digital scrub

You can fine-adjust the start or end time using the digital scrub function.

- (1) Use the [MENU] dial to highlight "<SCRUB-S>" or "<SCRUB-E>" and press the [ENTER] key.
The waveform around the start or end time is shown and you can now use the digital scrub function.

```
CHAIN PLAY SET▶LN001
[FNO]001
[NAME]Original.wav
[START]00h00m00s00f
[END] 00h48m52s12f
<SCRUB-S> <SCRUB-E>
<ADD> <CLEAR>
```



<Scrub screen for the start time>

Inserting a file to the list

You can insert a file to the current chain play list.

The following description shows the procedure example of inserting file 011 (SCENE_011.wav) between list number 004 and 005.

It is assumed that the chain play list is shown on the display.

- (1) Use the [MENU] dial to highlight list number "005" and press the [ENTER] key.
The display now shows the edit screen of the selected file.

```
CHAIN PLAY SET
TOTAL TIME:01h28m00s
[LN][FN] [NAME]
003 001 SCENE_001.wa
004 007 SCENE_007.wa
#005 006 SCENE_006.wa
006 004 SCENE_004.wa
```

```
CHAIN PLAY SET▶LN005
[FNO]006
[NAME]SCENE_006.wav
[START]00h00m00s00f
[END] 00h28m21s20f
<SCRUB-S> <SCRUB-E>
<SAVE> <DEL> <INS>
```

- (2) Use the [MENU] dial to highlight "<INS>" and press the [ENTER] key.
The display now shows the file list screen.

```
CHAIN PLAY SET▶LN005
[FNO]006
[NAME]SCENE_006.wav
[START]00h00m00s00f
[END] 00h28m21s20f
<SCRUB-S> <SCRUB-E>
<SAVE> <DEL> <INS>
```

```
C SET▶LN001▶FILE SEL
[FN] [NAME]
▶001 SCENE_001.wav
002 SCENE_002.wav
003 SCENE_003.wav
004 SCENE_004.wav
005 SCENE_005.wav
```

- (3) Use the [MENU] dial to highlight "011 SCENE_011.wav." and press the [ENTER] key.
File 011 is inserted to the play list as list number 005.

The files set after list number 005 move down in the list.

<List screen before inserting a file>

```
CHAIN PLAY SET
TOTAL TIME:01h28m00s
[LN][FN] [NAME]
003 001 SCENE_001.wa
004 007 SCENE_007.wa
▶005 006 SCENE_006.wa
006 004 SCENE_004.wa
```

<List screen after inserting a file>

```
CHAIN PLAY SET
TOTAL TIME:01h28m00s
[LN][FN] [NAME]
003 001 SCENE_001.wa
004 007 SCENE_007.wa
▶005 011 SCENE_011.wa ←
006 006 SCENE_006.wa
```

- (4) Use the [MENU] dial to highlight "<SAVE>" and press the [ENTER] key.
The display returns to the chain play list screen.

Deleting a file from the chain play list

You can delete a desired file from the current chain play list.

The following description shows the procedure example of deleting file 006 (SCENE_006.wav) at list number 005.

- (1) Use the [MENU] dial to highlight list number "005" and press the [ENTER] key.

The display now shows the edit screen of the selected file.

```
CHAIN PLAY SET
TOTAL TIME:01h23m00s
[LN][FN] [NAME]
003 001 SCENE_001.wa
004 007 SCENE_007.wa
▶005 006 SCENE_006.wa
006 004 SCENE_004.wa
```

```
CHAIN PLAY SET▶LN005
[FNO]006
[NAME]SCENE_006.wav
[START]00h00m00s00f
[END] 00h28m21s20f
<SCRUB-S> <SCRUB-E>
<SAVE> <DEL> <INS>
```

- (2) Use the [MENU] dial to highlight "" and press the [ENTER] key.

File 006 is deleted from the chain list.
The files set after list number 006 move up in the list.

```
CHAIN PLAY SET▶LN005
[FNO]006
[NAME]SCENE_006.wav
[START]00h00m00s00f
[END] 00h28m21s20f
<SCRUB-S> <SCRUB-E>
<SAVE> <DEL> <INS>
```

```
CHAIN PLAY SET
TOTAL TIME:01h23m00s
[LN][FN] [NAME]
003 001 SCENE_001.wa
004 007 SCENE_007.wa
▶005 004 SCENE_004.wa
006 005 SCENE_005.wa
```

- (3) Use the [MENU] dial to highlight "<SAVE>" and press the [ENTER] key.

The display returns to the chain play list screen.

Creating the timer play list

To execute timer play, the timer play list must be created.

- (1) While the unit is stopped, press the [ENTER] to enter the MENU mode.
- (2) Use the [MENU] dial to highlight "TIMER PLAY SET" and press the [ENTER] key.
The display shows the screen for setting the timer play list.



- (3) While TN (timer number) "001" is highlighted, press the [ENTER] key.
The display shows the screen for setting the file.

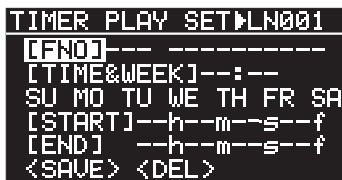

- (4) While "[FNO]" is highlighted, press the [ENTER] key.
The display shows the screen for selecting a file.



- (5) Use the [MENU] dial to select the desired file and press the [ENTER] key.
The selected file (for example, 002 SCENE_002.w) is set, and the display changes to show the screen for setting the playback start time and the days of the week, as well as the start and end points of the file.

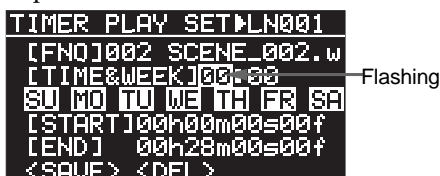

- (6) Set the playback start time and the days of the week.

The following procedure shows the example for setting the timer play as follows.

- The start and end points of the file are not changed.
- The playback start time is 8:30.
- The timer play is executed on every Monday through Friday.

<Procedure example for setting the playback start time and the days of the week>

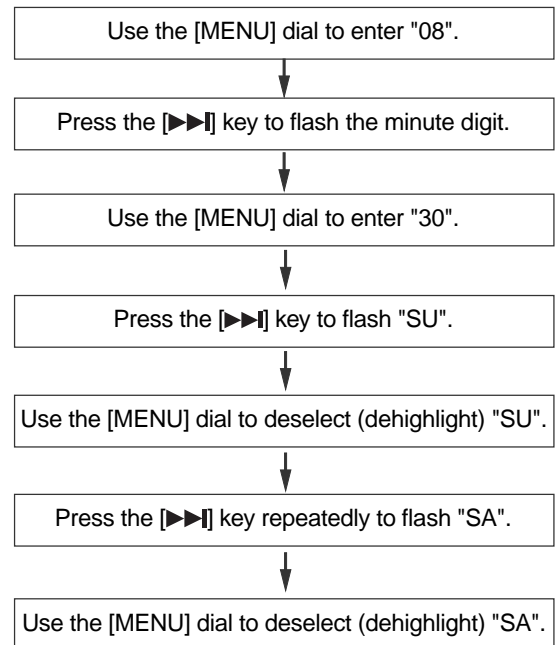

Now the display shows the screen as below.

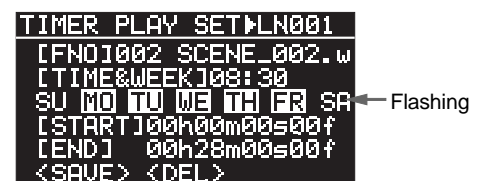

- (7) In the condition as above, press the [ENTER] key.
"<SAVE>" at the bottom of the screen is highlighted.

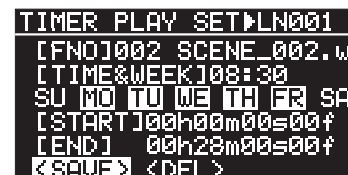

- (8) While "<SAVE>" is highlighted, press the [ENTER] key.
The selected file is set to the list and the display changes to show the following screen.

```
TIMER PLAY SET
[TN][TIME] [FILE]
001 08:30 SCENE_002.
002 --:-- -----
<SAVE>
<ALL CLEAR>
```

Up to 250 file can be set to the list. To add a file to the list, highlight "002" and press the [ENTER] key, then follow the same procedure as above.

<Memo>: By highlighting "<ALL CLEAR>" and pressing the [ENTER] key, all file entries are cleared. You can create the timer play list from the start.

- (9) Use the [MENU] dial to highlight "<SAVE>" and press the [ENTER] key. The confirmation screen as below appears. If you press the [ENTER] key again, the list will be saved as "TIMERLIST.CSV" with the CSV (Comma Separated Value) file format in which each value is separated by comma (see page 88).

```
TIMER PLAY SET
[TN][TIME] [FILE]
001 08:30 SCENE_002.
002 --:-- -----
<SAVE>
<ALL CLEAR>
```

↓

```
TIMER PLAY SET>SAVE
-Timer play list--
List save
[TIMERLIST.CSV ]
Are you sure? ←Flashing
Yes: [ENTER] key
No: [EXIT] key
```

- (10) Press the [ENTER] key again to execute saving. The display returns to the Home screen which was shown before the unit entered the menu mode. (To cancel saving the list, press the [EXIT] key.)

<Memo>: When you select the TIMER play mode while the timer play list is created, the unit reads the timer play list and the display shows the Home screen as below.

```
0h00m00s FILE s00f
0001 BWF 48/24 TIMER
NEXT EVENT 0008:30
FILE SCENE_002.wav
02008. AUG. 30 SA 12:33
```

On the Home screen, you can see that the unit will playback the file "SCENE_002.wav." at 8:30 on Monday by the timer play function. At the bottom, the current date, days of the week and time are shown.

Editing the timer play list

You can edit the timer play list. The following editing items are available.

- 1) Changing the file to be played back
- 2) Editing the time and the days of the week for playback.
- 3) Editing the start and end points of a file using the time edit function.
- 4) Replacing the start or end point with a CUE time.

- (1) While the unit is stopped, press the [ENTER] key to enter the MENU mode.
- (2) Use the [MENU] dial to highlight "TIMER PLAY SET" and press the [ENTER] key. The timer play list is shown.

```
MENU▶
FILE SEL ▶
STORAGE SEL ▶
MIC IN SETUP ▶
CHAIN PLAY SET ▶
←TIMER PLAY SET ▶
REMOTE SET ▶
```

↓

```
TIMER PLAY SET
[TN][TIME] [FILE]
001 08:30 SCENE_002.
002 --:-- -----
<SAVE>
<ALL CLEAR>
```

- (3) "Use the [MENU] dial to highlight the desired file number [FNO] and press the [ENTER] key." The display shows the setting screen for the selected file. You can now edit the current setting.

```
TIMER PLAY SET▶LN001
[FNO]002 SCENE_002.w
[TIME&WEEK]08:30
SU MO TU WE TH FR SA
[START]00h00m00s00f
[END] 00h28m00s00f
<SAVE> <DEL>
```

• Changing a File

- (1) While "FNO" is highlighted, press the [ENTER] key. The display shows the screen for selecting a file.
- (2) Use the [MENU] dial to highlight the desired file and press the [ENTER] key. The file to be played back is replaced with the selected file.
- (3) Execute the save operation in the same manner as described on page 50.

• Editing the time and days of the week

- (1) Use the [MENU] dial to highlight "[TIME&WEEK]" and press the [ENTER] key. In the initial condition, you can edit the time.

```
TIMER PLAY SET▶LN001
[FNO]002 SCENE_002.w
[TIME&WEEK]08:30
SU MO TU WE TH FR SA
[START]00h00m00s00f
[END] 00h28m00s00f
<SAVE> <DEL>
```

```
TIMER PLAY SET▶LN001
[FNO]002 SCENE_002.w
[TIME&WEEK]08:30
SU MO TU WE TH FR SA
[START]00h00m00s00f
[END] 00h28m00s00f
<SAVE> <DEL>
```

Flashing

- (2) Use the [◀◀] and [▶▶] keys to select the item (hour digit, minute digit, days of the week) to be edited, use the [MENU] dial to set each item, and press the [ENTER] key to confirm your setting.
- (3) Execute the save operation in the same manner as described on page 51.

• Editing the playback area of a file
<Using the time edit function>

- (1) Use the [MENU] dial to highlight "[START]" or "[END]" and press the [ENTER] key. The frame digit of the start or end point starts flashing and you can now edit the value.

```
TIMER PLAY SET▶LN001
[FNO]002 SCENE_002.w
[TIME&WEEK]08:30
SU MO TU WE TH FR SA
[START]00h00m00s00f
[END] 00h28m00s00f
<SAVE> <DEL>
```

```
TIMER PLAY SET▶LN001
[FNO]002 SCENE_002.w
[TIME&WEEK]08:30
SU MO TU WE TH FR SA
[START]00h00m00s00f
[END] 00h28m00s00f
<SAVE> <DEL>
```

Flashing

- (2) Use the [◀◀] and [▶▶] keys to select the flashing point, use the [MENU] dial to enter a desired value, and press the [ENTER] key to confirm your setting.
- (3) Execute the save operation in the same manner as described on page 50.

• Editing the playback area of a file
<Replacing with a CUE time>

<Note>: To execute the following operation, more than one CUE point must be set to the file to be edited. Without any CUE point, you cannot execute the following operation. If you replace the start (or end) time with a CUE time and then edit the CUE time, the replaced start (or end) time is not affected.

- (1) Use the [MENU] dial to highlight "[START]" or "[END]" and press the [CUE/LOCATE] key. The CUE list is shown on the display.

```
TIMER PLAY SET▶LN001
[FNO]002 SCENE_002.w
[TIME&WEEK]08:30
SU MO TU WE TH FR SA
[START]00h00m00s00f
[END] 00h28m00s00f
<SAVE> <DEL>
```

```
TIMER▶START SEL▶CUE
#01 BC$START **h**m**
#02 BC$END   **h**m**
#03 Cue 03   **h**m**
#04 Cue 04   **h**m**
#05 Cue 05   **h**m**
#06 Cue 06   **h**m**
```

- (2) Use the [MENU] dial to select the desired CUE and press the [ENTER] key to confirm the selection. The start (or end) point is replaced with the selected CUE point.
- (3) Execute the save operation in the same manner as described on page 51.

After you finish editing, press the [STOP] key to exit the MENU mode.

Cueing function

During playback, you can use the [▶▶ F FWD] or [◀◀ REW] key to enter cueing mode, in which you can cue (fast wind while monitoring audio) forward or backward at up to eight times the normal speed.

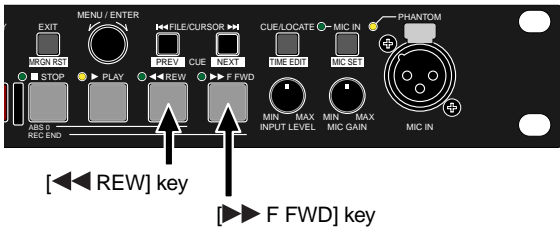

<Memo>: Each press of the [▶▶ F FWD] or [◀◀ REW] key changes the cueing speed among two, four, six and eight times the normal speed. While cueing is being performed, the display shows any of the following icons.

The number of key press	REW direction	FWD direction
One		
Two		
Three		
Four		
Five		

<Note>: The cueing speed at six or eight times the normal speed is available only for a file with 48 kHz FS or lower sampling frequency.

<Memo>: By default, playback audio while cueing is output from the [ANALOG OUT], [DIGITAL OUT] and [PHONES] connectors, therefore, you can monitor it using headphones or external monitor speakers. However, you can output audio only from the [PHONES] connector using the "Cue Monitor Out" item in the SYSTEM SETUP menu of the MENU mode. If you do not wish to output cueing audio from PA speakers, use this setting (see page 77 for details).

Repeat function

By setting the repeat function to "On", the unit repeats playback in the current playback mode until you press the [STOP] key. You can turn on or off the repeat function by pressing the [SHIFT] key to turn on the shift mode followed by the [TIME]/[REPEAT] key while the unit is stopped.

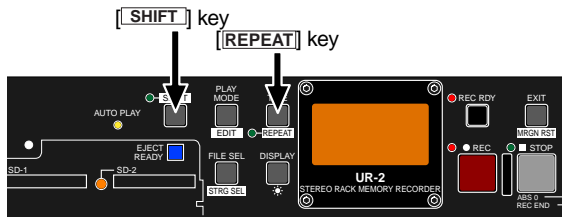

<Memo>: You can also turn on or off the repeat function using the "Repeat" menu item in the PLAY SETUP menu of the MENU mode (see page 57).

Auto play function

By setting the "Auto Play" menu item in the PLAY SETUP" menu of the MENU mode to "On", the unit automatically start playback after skipping to a desired file using the [◀◀] or [▶▶] key during playback (or after directly locating a marked position using the numeric keys of a USB keyboard).

By default, the "Auto Play" menu item is set to "On" and the [AUTO PLAY] indicator on the front panel is lit.

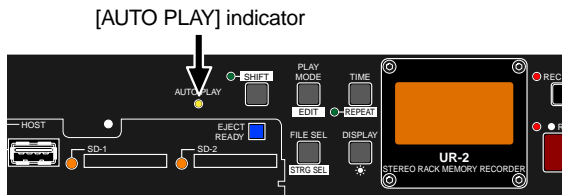

<Memo>: See "PLAY SETUP menu details" on page 57 for details about the "Auto Play" menu item.

<Memo>: If you use the [◀◀] or [▶▶] key while stopped to skip to a desired file, the unit stops at the beginning of the file without automatically starting playback even if the "Auto Play" menu item is set to "On".

Power on play function

By setting the "Power On Play" menu item in the PLAY SETUP menu of the MENU mode to "On" before turning off the power, the unit automatically start playback of files in the current storage device next time you turn on the power.

<Memo>: By default, the "Power On Play" menu item is set to "Off". See "PLAY SETUP menu details" on page 58 for details about the "Power On Play" menu item.

<Memo>: After turning on the power when the "Power On Play" menu item is set to "On", the unit starts playback in the playback mode you set before turning off the power. (Note that the power on play function is not active in the "MEMORY play mode" or "TIMER play mode".)

<Note>: To use a timer for power-on play, follow the procedure below.

- 1) Turn off the unit.
- 2) Connect a timer to the unit.
- 3) Set the timer appropriately.
- 4) Press the [POWER] switch to "On" (up) position.

<Note>: When more than one folder exists on the current storage, the power on play function does not work. The unit brings up the folder selection screen and stops after it is turned on (see page 29).

Digital scrub function

While the unit is stopped, pressing the [PLAY] key while holding down the [STOP] key enters the scrub mode, and the display changes to show the screen as below.

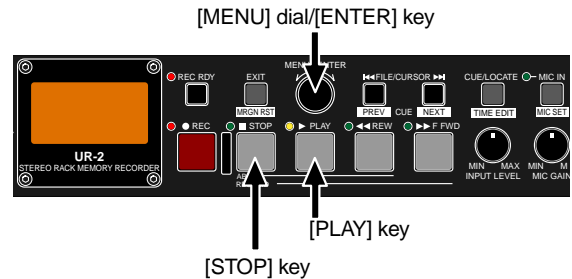

<Digital scrub screen>

The "▼" on the screen above indicates the current position. While this screen is shown, you can scrub forward or backward in approximately five to ten millisecond steps using the [MENU] dial.

After performing digital scrub, pressing the [ENTER] key exits the scrub mode.

PLAY SETUP menu details

The "PLAY SETUP" menu of the MENU mode has setting items regarding file playback. When you select the "PLAY SETUP" menu, the menu items are shown.



- (1) Play mode setting
- (2) Repeat function
- (3) Auto play function
- (4) Power on play function
- (5) Mono mix function

There are two method for selecting the "PLAY SETUP" menu as follows.

<Method 1>
 While the unit is stopped, press the [SHIFT] key to turn on the shift mode followed by the [PLAY MODE]/[EDIT] key.

<Note>: The method above is available only when the play mode is currently set to SINGLE, ALL or RELAY.

<Method 2>
 While the unit is stopped, press the [ENTER] key to enter the MENU mode, and use the [MENU] dial to highlight the [PLAY SETUP]>" menu, then press the [ENTER] key.

To exit the MENU mode, press the [STOP] key.

Play mode setting

You can set the play mode using the [PLAY MODE] key as well as using the MENU mode. The play mode set using the [PLAY MODE] key is reflected to the Play Mode menu item in the PLAY SETUP menu of the MENU mode.

By highlighting "Play mode" in the PLAY SETUP menu and pressing the [ENTER] key, the current play mode starts flashing and you can now select the desired play mode. (By default, "SINGLE" is selected.)

Use the [MENU] dial to select the desired play mode and press the [ENTER] key to confirm the selection.

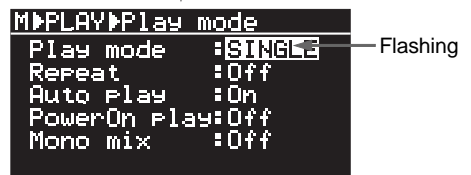
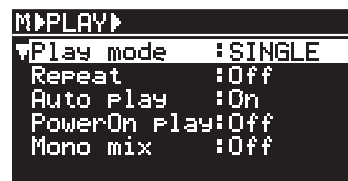

Available options

SINGLE (default), ALL, RELAY, CHAIN-S, CHAIN-A, MEMORY, TIMER

<Memo>: For details about each play mode, see page 41 described earlier.

<Note>: The CHAIN-S, CHAIN-A and MEMORY options are available only when the chain play list is created. The TIMER option is available only when the timer play list is created.

Repeat function

You can set the repeat function to on or off by pressing the [SHIFT] key to turn on the shift mode followed by the [REPEAT] key. The repeat function on/off set by the front key operation is reflected to the "Repeat" menu item in the PLAY SETUP menu of the MENU mode.

By highlighting "Repeat" in the PLAY SETUP menu and pressing the [ENTER] key, the current repeat setting starts flashing and you can now select on or off. (By default, "Off" is selected.)

Use the [MENU] dial to select "On" or "Off" and press the [ENTER] key to confirm the selection.

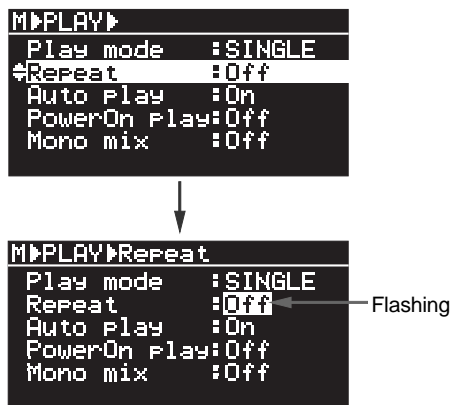

options	Details
Off	The [REPEAT] indicator on the front panel is unlit. After finishing playback according to the current play mode, the unit stops.
On	The [REPEAT] indicator on the front panel is lit. The unit repeatedly plays back files according to the current play mode until you stop playback.

Auto play function

By setting the "Auto Play" menu item to "On", the unit automatically start playback after skipping to a desired file using the [◀◀] or [▶▶] key during playback or after directly locating a marked position using the numeric keys of a USB keyboard.

By highlighting "Auto Play" in the PLAY SETUP menu and pressing the [ENTER] key, the current auto play setting starts flashing and you can now select on or off. (By default, "On" is selected.)

Use the [MENU] dial to select "On" or "Off" and press the [ENTER] key to confirm the selection.

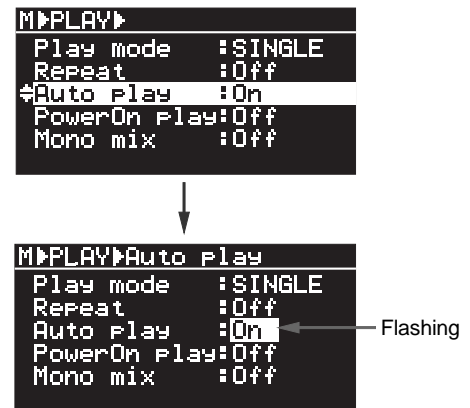

options	Details
Off	The [AUTO PLAY] indicator on the front panel is unlit. After skipping to or locating a position, the unit stops.
On	The [AUTO PLAY] indicator on the front panel is lit. After skipping to or locating a position, the unit automatically starts playback in the current play mode.

<Note>: The auto play function does not work when locating ABS 0 or REC END.

<Memo>: If you use the [◀◀] or [▶▶] key while stopped to skip to a desired file or select a file from the file selection screen, the unit stops at the beginning of the file without automatically starting playback.

Power on play function

The "Power On Play" function automatically starts playback after the unit is turned on.

By highlighting "Power On Play" in the PLAY SETUP menu and pressing the [ENTER] key, the current setting starts flashing and you can now select on or off. (By default, "Off" is selected.)

Use the [MENU] dial to select "On" or "Off" and press the [ENTER] key to confirm the selection.

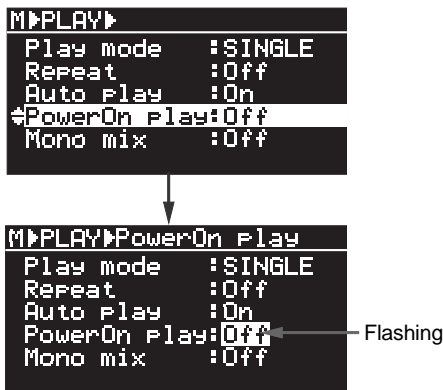

options	Details
Off	After the power is turned on, the unit stops at the beginning of the file.
On	After the power is turned on, the unit automatically starts playback in the current play mode.

<Note>: To activate power on play, a storage device on which one or more audio files are recorded must be set before the power is turned on.

<Note>: When the play mode is set to "MEMORY", the unit does not automatically start playback after the power is turned on even if the power on play function is set to "On".

<Note>: To use a timer for power on play, follow the procedure below.

- 1) Turn off the unit.
- 2) Connect a timer to the unit.
- 3) Set the timer appropriately.
- 4) Press the [POWER] switch to "On" (up) position.

<Note>: When more than one folder exists on the current storage, the power on play function does not work. The unit brings up the folder selection screen and stops after it is turned on (see page 29).

Mono mix function

You can mix stereo playback audio to mono.

By highlighting "Mono Mix" in the PLAY SETUP menu and pressing the [ENTER] key, the current setting starts flashing and you can now select on or off. (By default, "Off" is selected.)

Use the [MENU] dial to select "On" or "Off" and press the [ENTER] key to confirm the selection.

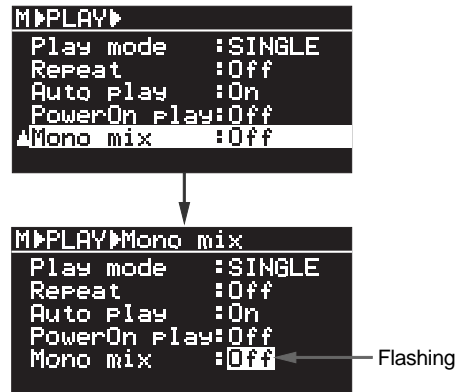

options	Details
Off	Audio is output in stereo. When playing back a mono audio file, the same audio is output from both the left and right output channels.
On	The left and right channels of stereo audio are mixed together. When playing back a mono audio file, the same audio is output from both the left and right output channels.

<Memo>: When the "Mono Mix" item is set to "On", the Home screen of the file looks like the following.

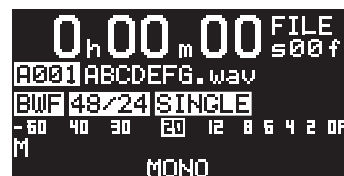

Locate/skip

Skipping among files

While the unit is stopped, pressing the [⏮] or [⏭] key skips to the beginning of the previous or next file. You can select the desired file by pressing the [⏮] or [⏭] key as many times as required.

<Memo>: If you execute the above operation during playback while the "Auto play" menu item in the PLAY SETUP menu of the MENU mode is set to "On", the unit automatically starts playback after skipping to a file. (By default, the "Auto play" menu item is set to "On".)

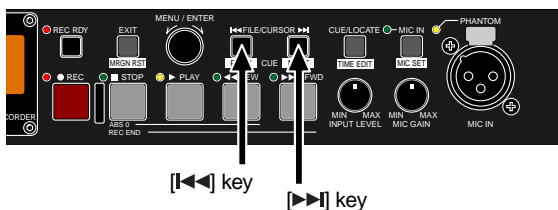

When you press the [⏮] or [⏭] key, the following popup window appears and the unit skips to the beginning of the previous or next file and stops.

When you press the [⏮] key

```
--SKIP FILE--
|<< File No[002]
SCENE_002.wav
```

When you press the [⏭] key

```
--SKIP FILE--
>>| File No[003]
SCENE_003.wav
```

Skipping among CUE points

By pressing the [SHIFT] key to turn on the [SHIFT] indicator followed by the [PREV] key or [NEXT] key, the unit skips to the CUE point previous from or next to the current position and stops. You can select the desired file by pressing the key repeatedly.

<Memo>: If you execute the above operation during playback while the "Auto play" menu item in the PLAY SETUP menu of the MENU mode is set to "On", the unit automatically starts playback after skipping to a CUE point. (By default, the "Auto play" menu item is set to "On".)

<Note>: If no CUE point is set to the file, you cannot execute the above operation.

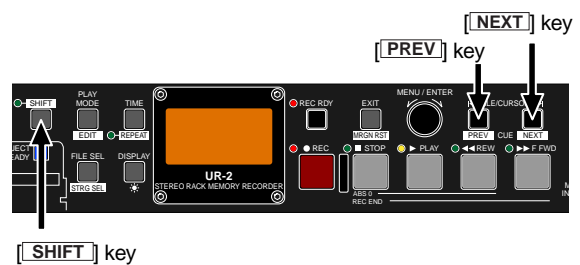

When you press the [SHIFT] key to turn on the [SHIFT] indicator followed by the [PREV] key or [NEXT] key, the following popup window appears and the unit skips to the previous or next CUE point and stops.

When you press the [PREV] key

```
|<< CUE No[003]
Cue 03
00h12m38s11f23sf
```

When you press the [NEXT] key

```
>>| CUE No[004]
Cue 04
00h32m18s24f43sf
```

Locating the beginning of a file

While the unit is stopped, by holding down the [STOP] key and pressing the [REW] key, the unit locates the beginning (ABS 0) of the current file and stops.

Locating the end of a file

While the unit is stopped, by holding down the [STOP] key and pressing the [F FWD] key, you can locate the last recording position (REC END) of the current file and stops.

Locating a CUE point

By selecting a desired CUE from the CUE list of the current file you can locate the CUE point.

<Memo>: If you execute the operation below during playback while the "Auto play" menu item in the PLAY SETUP menu of the MENU mode is set to "On", the unit automatically starts playback after locating a CUE point. (By default, the "Auto play" menu item is set to "On".)

- (1) While the unit is stopped, press the [CUE/LOCATE] key.
The display shows the CUE LIST screen.

CUE LIST▶			
01	BC\$START	00h08m00	
02	BC\$END	00h12m00	
03	Cue 03	00h34m00	
04	Cue 04	00h56m00	
05	Cue 05	01h12m00	
06	Cue 06	01h34m00	

- (2) Use the [MENU] dial to select a desired CUE and press the [CUE/LOCATE] key again.
The unit locates the selected CUE point and the display returns to the Home screen.

CUE LIST▶			
01	BC\$START	00h08m00	
02	BC\$END	00h12m00	
03	Cue 03	00h34m00	
04	Cue 04	00h56m00	
05	Cue 05	01h12m00	
06	Cue 06	01h34m00	

0	h	56	m	00	FILE
A001	ABCDEF	G	.	wav	S00f
BWF 48/24 SINGLE					
-60	40	30	20	12	0 6 4 2 0P

Locating a position by specifying the time

You can locate a position on the current file by specifying the time.

<Memo>: If you execute the operation below during playback while the "Auto play" menu item in the PLAY SETUP menu of the MENU mode is set to "On", the unit automatically starts playback after locating the specified position. (By default, the "Auto play" menu item is set to "On".)

- (1) While the unit is stopped or during playback, press the [SHIFT] key to turn on the shift mode followed by the [CUE/LOCATE] key.
The time when you press the [CUE/LOCATE] key is hold and the display shows the time editing screen.



- (2) Enter the time of the position you want to locate.
To edit the time, use the [◀◀] and [▶▶] keys to select the flashing point and use the [MENU] dial to enter a desired value (you can also edit the time using a USB keyboard).
- (3) After you enter the time, press the [ENTER] key.
The unit immediately locates the specified position and stops.

Direct locate using the numeric keys

While a USB keyboard is connected to the unit, you can use the numeric (0 through 9) and [Del /.] keys to specify a desired file number and locate the file.

To specify a one-digit file number, simply press a corresponding numeric key (0 through 9).

The [Del /.] key functions as "+10" key so you can specify any two- or three-digit file number by pressing this key as many times as required, followed by any numeric key. For example, to specify file number "28", press the [Del /.] key twice followed by the [8] key.

<Memo>: If you execute the operation above while the "Auto play" menu item in the PLAY SETUP menu of the MENU mode is set to "On", the unit automatically starts playback after locating the file. (By default, the "Auto play" menu item is set to "On".)

Controlling from an external device

You can control the unit from an external device via the [PARALLEL REMOTE] connector, [RS232C REMOTE] connector or [FOOT SW] jack.

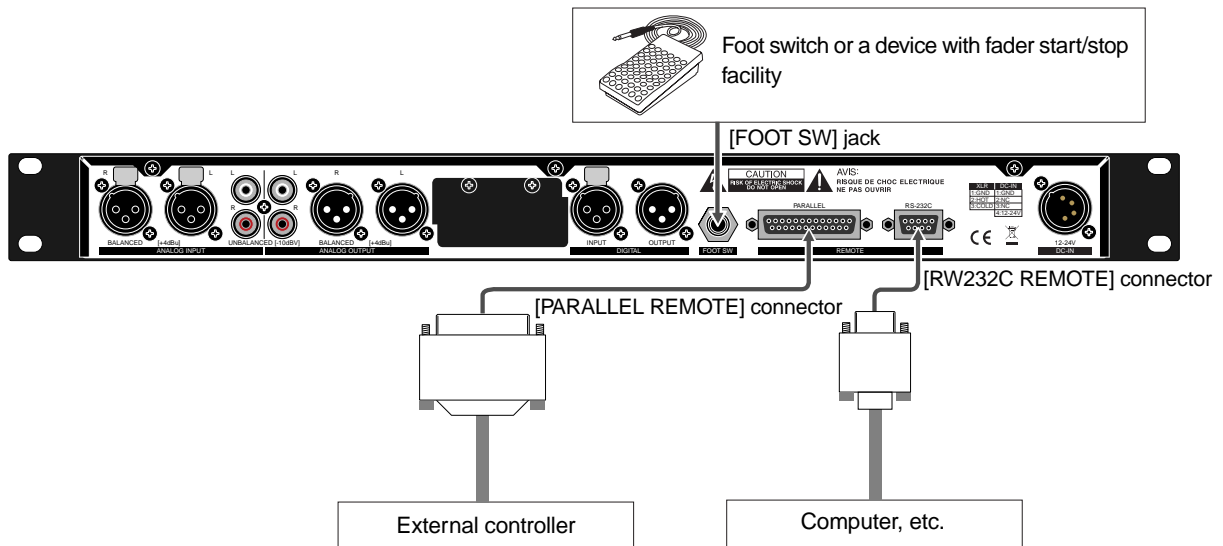

Setting REMOTE SET menu

To control the unit from an external device, set the "Remote Sel." menu item in the REMOTE SET menu of the MENU mode, as well as the "Parallel Setup" or "RS232C setup" menu item depending on connection.

- 1) While the unit is stopped, press the [ENTER] key to enter the MENU mode.
- 2) Use the [MENU] dial to highlight "REMOTE SET" and press the [ENTER] key. The menu items of the REMOTE SET menu are shown.

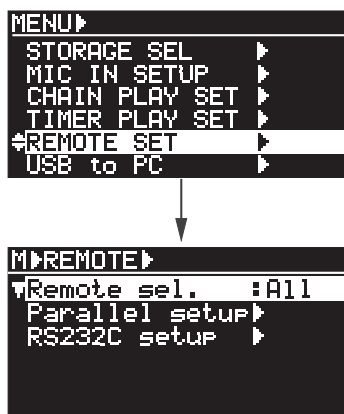

- 3) While "Remote Sel" is highlighted, press the [ENTER] key. The current setting ("All" by default) flashes. You can select from the following options.

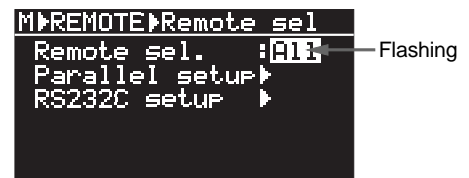

All	You can control the unit both from the front panel keys/controls and externally.
Local	You cannot control the unit externally.
Remote	You can only control the unit externally. The front panel keys/controls are disabled except the [ENTER] and [EXIT] keys.

- 4) Use the [MENU] dial to select "All" (or "Remote") and press the [ENTER] key to confirm the setting.

Depending on connection, set the "Parallel Setup" or "RS232C Setup" menu item appropriately.

Using [PARALLEL REMOTE] connector

You can control the unit from an external controller using the [PARALLEL REMOTE] connector.

For controlling the unit remotely, set the "Remote Sel." menu item in the REMOTE SET menu of the MENU mode to "All" or "Remote", as described in the previous page.

The following table shows the pin assignment of the [PARALLEL REMOTE] connector. Each command is executed by short-circuiting the associated pin (any of 3 through 12 and 15 through 24) with the GND pin.

<Memo>: The TALLY signals are used for transport status indication. You can use them for turning on indicators, etc.

Pin No.	Signal	IN/OUT
1	STOP TALLY	OUT (OC)
2	REC TALLY	OUT (OC)
3	STOP	IN
4	REC	IN
5	FF (SKIP)	IN
6	SHIFT	IN
7	10key-0	IN
8	10key-2	IN
9	10key-4	IN
10	10key-6	IN
11	10key-8	IN
12	FOOT SW	IN
13	GND	-
14	PLAY TALLY	OUT (OC)
15	+10key	IN
16	PLAY	IN
17	REC RDY	IN
18	REW (SKIP)	IN
19	MIC IN	IN
20	10key-1	IN
21	10key-3	IN
22	10key-5	IN
23	10key-7	IN
24	10key-9	IN
25	VCC (+5V)	-

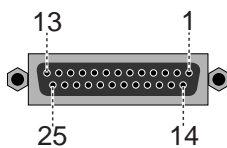

OUT: Open collector output for transport status signal (max. voltage: 5 V, max. current: 50 mA)

<Note>: The supply current of VCC is 200 mA max. Do not short-circuit the VCC port (pin #25).

<Memo>: The [FOOT SW] jack shares pin #12 (FOOT SW) and pin #13 (GND) of the [PARALLEL REMOTE] connector.

<Note>: The [FOOT SW] jack has the reverse setting of Close/Open (Close by default). See the following section for details.

Using [FOOT SW] jack

By connecting a footswitch or an external device which provides the fader start/stop terminals to the [FOOT SW] jack, you can control playback/stop of the unit remotely.

For controlling the unit remotely, set the "Remote Sel." menu item in the REMOTE SET menu of the MENU mode to "All" or "Remote", as described in the previous page. Also appropriately set the "Foot SW. Mode" item of the "Parallel Setup" menu item in the REMOTE SET menu if required (see below).

Setting "Foot SW. Mode"

In the following procedure, it is assumed that the display shows the main menu screen of the REMOTE SET menu, on which the "Remote Sel." menu item is set to "All".

- (1) Use the [MENU] dial to highlight "Parallel Setup" and press the [ENTER] key.

The display shows the "Foot SW, Mode" setting screen.

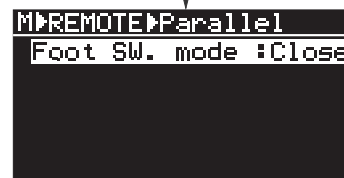
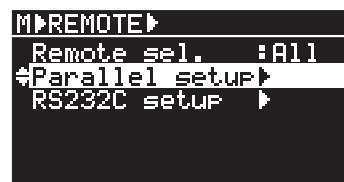

- (2) Press the [ENTER] key. The current setting (CLOSE by default) starts flashing and you can now select CLOSE or OPEN.

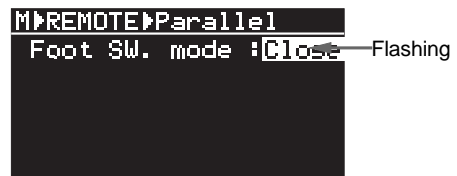

Close	The unit starts playback when the external switch is closed.
Open	The unit starts playback when the external switch is open.

- (3) Use the [MENU] dial to select CLOSE or OPEN and press the [ENTER] key to confirm the selection.
- (4) Press the [STOP] key to exit the MENU mode.

Using the [RS232C] port

By connecting the [RS232C] port of the unit to the RS-232C port of your computer, you can control the unit from the computer.

For controlling the unit via RS232C remotely, set the "Remote Sel." menu item in the REMOTE SET menu of the MENU mode to "All" or "Remote", as described in the previous page. Also set the baud rate using the "RS232C Setup" menu item in the REMOTE SET menu if required.

The table below shows the pin assignment of the [RS232C] port.

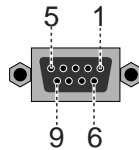

Pin No.	Signal	IN/OUT
1	NC	—
2	TX	OUT
3	RX	IN
4	NC	—
5	GND	—
6	NC	—
7	NC	—
8	NC	—
9	NC	—

<Specifications>

- Cable: Male-female, straight cable
- Baud rate: Selectable from 9600, 19200, 38400, 57600 and 115200 (default) bps
- Data bit: 8 bits
- Parity bit: Non
- Stop bit: 1 bit

Setting "RS232C Setup" menu

You can set the baud rate of the control signal using the "RS232C Setup" menu item.

In the following procedure, it is assumed that the display shows the main menu screen of the REMOTE SET menu, on which the "Remote Sel." menu item is set to "All".

- (1) Use the [MENU] dial to highlight "RS232C Setup" and press the [ENTER] key.

The display shows the RS232C setup screen. On this screen, you can only select the baud rate. The other items are display-only.

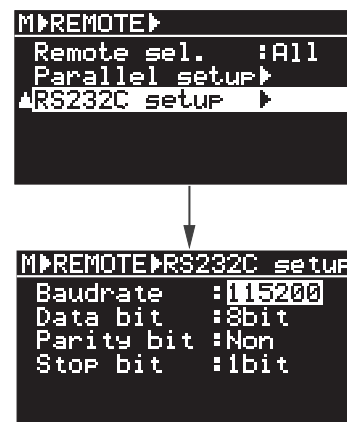

- (2) While the baud rate value is highlighted, press the [ENTER] key.

The current setting ("115200" by default) starts flashing and you can now select a baud rate from the following.

9600, 19200, 38400, 57600, and 115200 (default) bps



- (3) Use the [MENU] dial to select the desired baud rate and press the [ENTER] key to confirm the selection.

- (4) Press the [STOP] key to exit the MENU mode.

Command configuration (data arrangement)

Each command corresponds to a key function assigned to a front panel key and parallel remote pin. No multiple press, simultaneous press or SHIFT press is supported. Commands are sent directly. By entering text from Tera Term, etc., according to the Command list shown later, you can simply control the unit.

Byte	0	1	2 ~ 12	13, 14	15
	STX	c/s	Command/status code (checksum)	Checksum	ETX
	02h	63h/73h	Command/status code (hex)	20h, 20h	03h

----- Checksum calculation range -----

[Byte 0]: Start byte

Every series of commands of the unit starts with start byte (02h).

[Byte 1]: Command/status byte

Selects command or status request. The lowercase "c" (63h) indicates a command, while the lowercase "s" (73h) indicates a status.

[Byte 2 through 12]: Command/status code

These eleven bytes are reserved for parameters regarding a command or status request. If the status information is less than eleven bytes, a space (20h) is inserted.

[Byte 13 and 14]: Checksum

Sums hexadecimal data of byte 1 through byte 12 and represents the lower two digits of the result in hexadecimal.

<Example>: PLY (PLAY command)

63 (c) + 50 (P) + 4C (L) + 59 (Y) = 158 ->58
 byte 13: "5" -> 35h
 byte 14: "8" -> 38h

[Byte 15]: End byte

Each data is ended with the end byte (03h).

Command control list

* Controlled by ASCII characters.

* When the unit receives a command, it sends the status information.

If the command is remotely controllable, the unit adds "r" to the command status byte and sends back the same character string as the command. If the command is not remotely controllable, the unit adds "s" to the command status byte and sends back the same character string as the command.

<Commands related to transport keys>

	ASCII (A blank is a space.)												HEX																					
	STX	1	2	3	4	5	6	7	8	9	10	11	12	CHK	CHK	ETX	STX	1	2	3	4	5	6	7	8	9	10	11	12	CHK	CHK	ETX		
REC		c	R	E	C									3	D		02	63	52	45	43	20	20	20	20	20	20	20	20	20	20	33	44	03
STOP		c	S	T	P									5	A		02	63	53	54	50	20	20	20	20	20	20	20	20	20	20	35	41	03
PLAY		c	P	L	Y									5	8		02	63	50	4C	59	20	20	20	20	20	20	20	20	20	20	35	38	03
REW		c	R	E	W									5	1		02	63	52	45	57	20	20	20	20	20	20	20	20	20	20	35	31	03
FFWD		c	F	W	D									4	4		02	63	46	57	44	20	20	20	20	20	20	20	20	20	20	35	34	03
SKIP<<		c	S	K	+									2	C		02	63	53	4B	2B	20	20	20	20	20	20	20	20	20	34	43	03	
SKIP>>		c	S	K	-									2	E		02	63	53	4B	2D	20	20	20	20	20	20	20	20	20	32	45	03	
ABS 0		c	A	B	O									1	6		02	63	41	42	30	20	20	20	20	20	20	20	20	20	31	36	03	
REC END		c	R	E	D									3	E		02	63	52	45	44	20	20	20	20	20	20	20	20	20	33	45	03	

<Commands related to numeric keys>

	ASCII (A blank is a space.)												HEX																				
	STX	1	2	3	4	5	6	7	8	9	10	11	12	CHK	CHK	ETX	STX	1	2	3	4	5	6	7	8	9	10	11	12	CHK	CHK	ETX	
0		c	K	Y	0									3	7		02	63	4B	59	30	20	20	20	20	20	20	20	20	20	33	37	03
1		c	K	Y	1									3	8		02	63	4B	59	31	20	20	20	20	20	20	20	20	20	33	38	03
2		c	K	Y	2									3	9		02	63	4B	59	32	20	20	20	20	20	20	20	20	20	33	39	03
3		c	K	Y	3									3	A		02	63	4B	59	33	20	20	20	20	20	20	20	20	20	33	41	03
4		c	K	Y	4									3	B		02	63	4B	59	34	20	20	20	20	20	20	20	20	20	33	42	03
5		c	K	Y	5									3	C		02	63	4B	59	35	20	20	20	20	20	20	20	20	20	33	43	03
6		c	K	Y	6									3	D		02	63	4B	59	36	20	20	20	20	20	20	20	20	20	33	44	03
7		c	K	Y	7									3	E		02	63	4B	59	37	20	20	20	20	20	20	20	20	20	33	45	03
8		c	K	Y	8									3	F		02	63	4B	59	38	20	20	20	20	20	20	20	20	20	33	46	03
9		c	K	Y	9									4	0		02	63	4B	59	39	20	20	20	20	20	20	20	20	20	34	30	03
10+		c	K	0	+									0	9		02	63	4B	30	2B	20	20	20	20	20	20	20	20	30	39	03	

<Response>

	ASCII (A blank is a space.)												HEX																				
	STX	1	2	3	4	5	6	7	8	9	10	11	12	CHK	CHK	ETX	STX	1	2	3	4	5	6	7	8	9	10	11	12	CHK	CHK	ETX	
Correct receipt		r	S	T	P									6	9		02	72	53	54	50	20	20	20	20	20	20	20	20	20	35	39	03
Not remutable		s	R	N	G									5	A		02	73	52	4E	47	20	20	20	20	20	20	20	20	20	35	41	03
Error		r	E	R	R									5	B		02	72	45	52	52	20	20	20	20	20	20	20	20	20	35	42	03
Error (BUSY)		r	B	G	Y									5	4		02	72	42	47	59	20	20	20	20	20	20	20	20	20	35	34	03

File transfer between the unit and your computer

By connecting the [USB-PC] connector of the unit to a computer, you can transfer an audio file (BWF file) recorded on an SD card using the unit to the computer.

An audio file recorded to an SD card using the UR-2 can be copied to a hard disk drive in a computer, or import to a computer software application such as Digidesign Pro Tools. This connection is also used when transferring an upgraded software downloaded from the Fostex website to the unit.

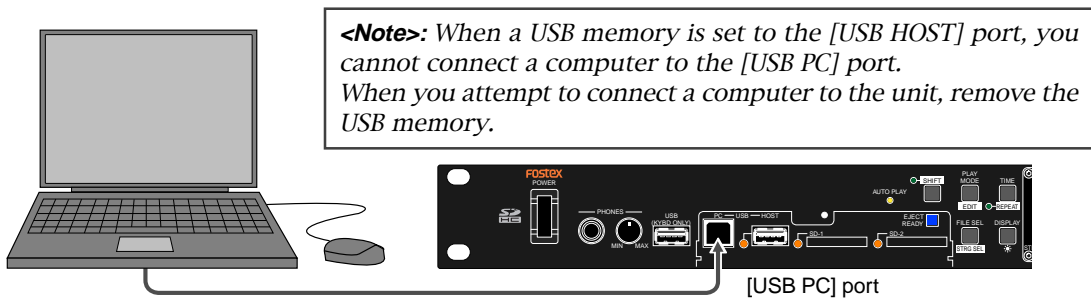

<Note>: You can only transfer an audio file recorded on an SD card set to the SD1 or SD2 slot.

<Note>: A computer connected to the unit must support either of Windows ME, 2000, XP, vista, or Macintosh OS X. Check that your computer supports either of these operating systems.

* All company names and model names mentioned in this manual are trademarks or registered trademarks of their respective holders.

Connecting a computer to the unit

After connecting the unit and a computer using a USB cable, set the "USB to PC" menu of the MENU mode appropriately.

In the following procedure example, it is assumed that the unit is connected to a Windows XP computer.

- (1) Turn on both the computer and the unit.
- (2) While the unit is stopped, press the [ENTER] key to enter the MENU mode.
- (3) Use the [MENU] dial to highlight "USB to PC" and press the [ENTER] key. The display now shows the screen for confirming USB connection.
- (4) Press the [ENTER] key. USB connection is established and the display now shows the following screen.

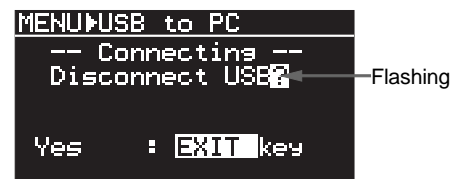

You can transfer data between the unit and the computer while the screen above is shown.

<Memo>: When connection is established, the SD card set to the unit is mounted to the computer and the removable disk drive is shown on the computer. If two SD cards are set to the unit, two drives are mounted to the computer (indicated by arrows in the screen example below).



<Protection of an SD card>

The screen for confirming USB connection also shows the protection status of an SD card set to the unit. In the following screen example, both SD cards set to the unit are not protected. In this condition, you can read from and write to the SD cards.

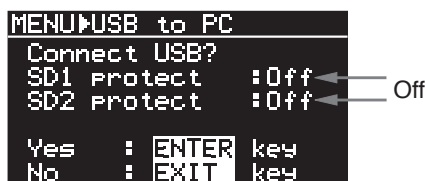

To avoid destroying file data on an SD card by performing inappropriate operation of the computer, it is recommended to protect the SD card.

When protection is set to On, the screen shows "On" and the SD card is "read only". (In the following screen example, both the card on the SD1 and SD2 slots are protected.)



Copying a file to a computer

You can copy a file from an SD card set to the unit to a computer.

In the following procedure, it is assumed that in the "My computer" window, you can see a "Removable disk" is mounted on the computer.



<Note>: When you copy a file to your computer, do not perform "Move to Folder", "Move to Folder" operation deletes the original file from the SD card.

- (1) Open the "Removable disk" and copy the desired audio file in the BWFF folder to the computer.
- (2) After copying the file to the computer, perform "Safely Remove hardware" on the computer and unplug the USB cable.
- (3) Press the [EXIT] key on the unit to release USB connection.

Copying a file from a computer

You can copy a file from a computer to an SD card set to the unit. You can also use this function when upgrading the unit by downloading the software upgrade file from the Fostex website and copying it to an SD card. (See page 69 for details about upgrading the unit.)

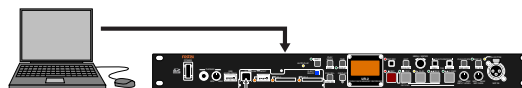

<Note>: Before executing the following procedure, make sure that the destination SD card is not protected.

In the following procedure, it is assumed that in the "My computer" window, you can see a "Removable disk" is mounted on the computer.

- (1) Copy the desired audio file (BWF file) to the "BWFF" folder in the removable disk on "My computer" (see page 29).
When you copy the software upgrade file, the destination is the root folder.
- (2) After copying the file from the computer, perform "Safely Remove hardware" on the computer and unplug the USB cable.
- (3) Press the [EXIT] key on the unit to release USB connection.

Using a USB keyboard

By connecting a USB keyboard or numeric keyboard to the [USB (KYBD ONLY)] port, you can edit a file name or volume label in the MENU mode as well as control the transport.

<Note>: When you connect a USB keyboard, set the keyboard type appropriately using the "Keyboard type" item in the "SYSTEM SETUP" menu of the MENU mode (see page 78). By default, it is set to "US" type.

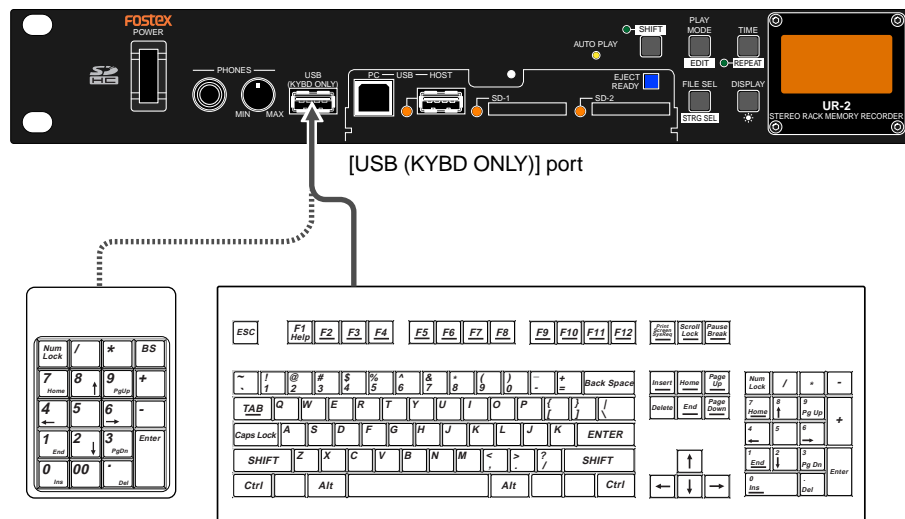

Keys on a keyboard and assigned functions

• Function keys on a USB keyboard

F1	Calls up the "Edit File Name" menu item in the STORAGE UTILITY menu of the MENU mode.
F3	Calls up the "Default File Name" menu item in the SYSTEM SETUP menu of the MENU mode.
F4	Sets the play mode to "CHAIN ALL".
SHIFT + F4	Sets the play mode to "CHAIN SINGLE".
F5	Sets the play mode to "ALL".
SHIFT + F5	Sets the play mode to "SINGLE".
F6	Sets the play mode to "MEMORY".
F7	Activates REC READY.
SHIFT + F7	Deactivates REC READY.
F8	Acts the same as the [REC] key of the UR-2.
F9	Acts the same as the [STOP] key of the UR-2.
F10	Acts the same as the [PLAY] key of the UR-2.
F11	Acts the same as the [REW] key of the UR-2.
F12	Acts the same as the [F FWD] key of the UR-2.

• **Control keys on a USB keyboard**

Ctrl + L	Acts the same as the [CUE/LOCATE] key of the UR-2. The locate function is executed.
-----------------	---

• **Shortcut keys on a USB keyboard**

ALT + F	Enters audio file selection mode.
ALT + D	Enters storage device selection mode.
ALT + S	Calls up the SYSTEM SETUP menu of the MENU mode.
ALT + P	Calls up the PLAY SETUP menu of the MENU mode.
ALT + L	Calls up the CHAIN PLAY SETUP menu of the MENU mode.
ALT + U	Calls up the STORAGE UTILITY menu of the MENU mode.

• **Other keys on a USB keyboard**

← → ↓ ↑	Moves the editing point or scrolls the display.
BS	Executes the back space function.
DEL	Deletes a character when editing a name/label.
ESC	Acts the same as the [EXIT] key of the UR-2.
ENTER	Acts the same as the [ENTER] key of the UR-2.
HOME	Returns to the Home screen.
SPACE	Acts the same as the [STOP] key of the UR-2.
- >	Acts the same as the [▶▶] key of the UR-2.
< -	Acts the same as the [◀◀] key of the UR-2.

• **Keys on a numeric keyboard**

0 ~ 9	Acts as numeric keys as well as memory keys.
/	Acts the same as the [◀◀] key of the UR-2.
*	Acts the same as the [▶▶] key of the UR-2.
-	Acts the same as the [SHIFT] key of the UR-2.
+	Acts the same as the [PLAY] key of the UR-2.
ENTER	Acts the same as the [STOP] key of the UR-2.
del . (.)	Acts as the "+10" key.

<Note>: The key functions of a USB or numeric keyboard may be expanded in the future.

Upgrading the UR-2

To upgrade the UR-2, download the upgrade file from the Fostex website (<http://www.fostex.com>) to your computer and copy it to an SD card or USB memory using either of the following two method, then execute the upgrade file (check the Fostex website about the latest software information of the UR-2).

<Method 1>: Connect the UR-2 to your computer using the "USB to PC" menu of the MENU mode and copy the upgrade file downloaded from the computer to the SD card set to the UR-2 (you cannot use a USB memory while the UR-2 is connected to the computer). See "File transfer between the UR-2 and your computer" for details about file transfer between the UR-2 and your computer on page 65.

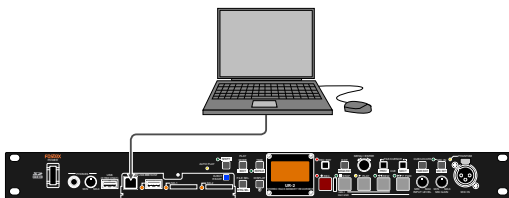

<Method 2>: Set a USB memory or SD card (directly or via a card adaptor) to your computer and copy the upgrade file from the computer to the USB memory or SD card.

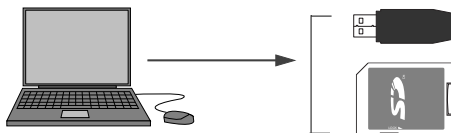

Executing software upgrade

In the following procedure, it is assumed that only a storage device (SD card or USB memory) in which the upgrade file with the ".mot" extension is copied using either of two methods above is set to the unit.

- (1) **Turn on the UR-2.**
The UR-2 starts up.
After reading the upgrade file, the following screen is shown.

```
--VerUP Main--
UR2U***.MOT
ENTER: Yes, EXIT: No
```

- (2) **Press the [ENTER] key.**
The unit starts software upgrade and the progress is shown on the screen.

After finishing upgrade, the display briefly shows "Complete" and returns to the Home screen.

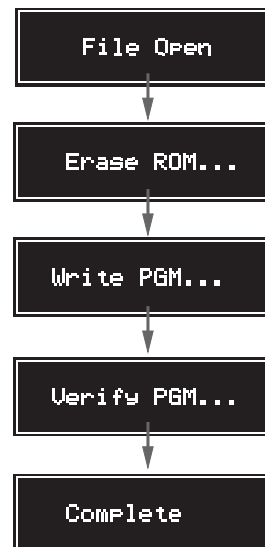

<Note>: All keys are disabled during upgrade. Do not turn off the power during upgrade. If you do so, the unit may not start up.

- (3) **After finishing upgrade, eject the storage device, then turn off and on the unit.**
If required, perform "SYS. initial memory" in the SYSTEM SETUP menu of the MENU mode (see page 81).

<Note>: If you turn on the unit without ejecting the storage device, the UR-2 recognizes the software upgrade file and the screen shown in the procedure (1) is displayed again. In this case, the [EXIT] key to cancel.

<Note>: To delete the upgrade file, connect the unit to your computer or mount the SD card or USB memory directly to the computer, and delete the file by using the computer.

MENU mode

About MENU mode

In the MENU mode, there are various setting and execution menu items.

By pressing the [ENTER] key while the unit is stopped the unit enters the MENU mode and the display shows the main menu screen.

There are ten menus. You can enter the desired menu by using the [MENU] dial to highlight the menu and pressing the [ENTER] key.

This section describes details about the "SYSTEM SETUP" and "STORAGE UTILITY" menu in the main menus. For details about the other menus, see the pages shown in the table below.

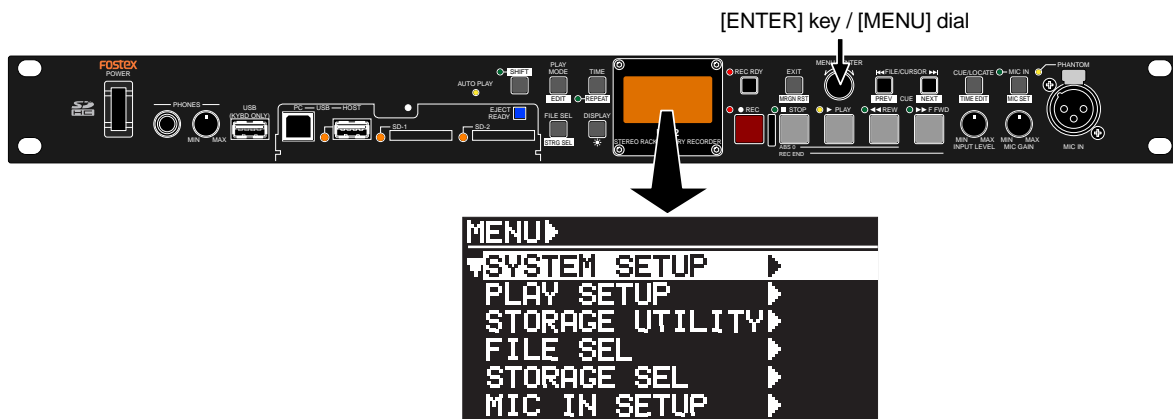

Main menu	Contents
SYSTEM SETUP	You can make settings for operation environment of the UR-2 (see the next pages).
PLAY SETUP	You can make settings for playback. The "Play Mode" and "Repeat" items can be set using the [PLAY MODE] and [REPEAT] keys on the front panel (see pages 41 and 54).
STORAGE UTILITY	You can make settings for managing storage devices (SD card/USB memory) and recorded audio files (see page 82).
FILE SEL	You can select a file to be played back on the file selection screen. You can also bring up the file selection screen using the [FILE SEL] key on the front panel (see page 42).
STORAGE SEL	You can select the current storage device for recording/playback on the storage selection screen. You can also bring up the storage selection screen by pressing the [SHIFT] key followed by the [FILE SEL] key (see page 28).
MIC IN SETUP	Consists of five menu items for settings required for using a microphone via the [MIC IN] connector. You can also bring up the storage selection screen by pressing the [SHIFT] key followed by the [MIC IN] key (see page 39).
CHAIN PLAY SET	Creates or edits the chain play list for chain play and memory play (see page 46).
TIMER PLAY SET	Creates or edits the timer play list for timer play (see page 51).
REMOTE SET	Consists of menu items for settings required for controlling the unit from an external device (see page 61).
USB to PC	Used for enabling or disabling USB connection between the unit and a computer for data transfer (see page 65).

SYSTEM SETUP menu details

The SYSTEM SETUP menu consists of 18 menu items. You can make settings for operation environment of the UR-2. The table below shows the setting options for each menu item as well as the default setting.

<Note>: For details about the "Display INV." and "Adjust RTC" menu items, see page 24 and 23 respectively. This section describes details about the other menu items.

<Note>: The "Record Mode" menu item is fixed to "Normal" in this software version.

Menu item	Setting options	Default setting	
Default file name	File name mode	Date, Take, Reel	Take
	Scene name	Up to 18 characters can be entered.	SCENE
	Take number	001 ~ 999	001
Select input	Analog, Digital	Analog	
Record FS/bit	44K/16, 48K/16, 44K/24, 48K/24, 88K/24, 96K/24	44K/16	
Record CH.	Stereo, Mono	Stereo	
Record mode	Normal only	Normal	
Max. file length	2G, 4G	4G	
Peak hold ttime	0 ~ 9sec	3sec.	
REF. level	-12dBFS, -20dBFS	-20dBFS	
Cue monitor out	ALL, HP	ALL	
Digital out	AES/EBU, SP DIF	AES/EBU	
Display INV.	Off, On	Off	
Keyboard type	US, APAN	US	
SYS. user save	Saves the settings of the SYSTEM SETUP and PLAY SETUP menu to the user system memory.	-	
SYS. user load	Loads the user system memory.	-	
SYS. default set	Initializes the system memory for the SYSTEM SETUP and PLAY SETUP menu.	-	
SYS. initial memory	Initializes the system memory as well as deletes the flash memory information.	Factory shipped setting	
Adjust RTC.	**Y **M **D **h **m **s	Factory shipped setting	
Version	Displays the current system version.	Factory shipped setting	

Basic operation of SYSTEM SETUP menu

Though the operation slightly differs depending on the menu item, the basic operation is as follows. In the following procedure, it is assumed that a new or recorded storage device is set to the unit.

- (1) While the unit is stopped, press the [ENTER] key to enter the MENU mode.

When you first enter the MENU mode, "SYSTEM SETUP" is highlighted as shown below.

```
MENU>
SYSTEM SETUP >
PLAY SETUP >
STORAGE UTILITY>
FILE SEL >
STORAGE SEL >
MIC IN SETUP >
```

- (2) While "SYSTEM SETUP" is highlighted, press the [ENTER] key.

The SYSTEM SETUP menu screen is shown. By default, "Default file name" is highlighted.

```
M>SYS>
Default file name>
Select input:Analog
Record FS/bit:44k/16
Record CH. :Stereo
Record mode :Normal
MAX. file length:4G
```

- (3) Use the [MENU] dial to select a desired menu item and press the [ENTER] key.

When you select a menu item with ">" at the far right, the display shows the next level screen in the menu. When you select a menu item without ">", the current setting starts flashing and you can make setting on this screen.

Example of selecting a menu item with ">"
The display shows the next level screen.

```
M>SYS>
Default file name>
Select input:Analog
Record FS/bit:44k/16
Record CH. :Stereo
Record mode :Normal
MAX. file length:4G
↓
M>SYS>Def.file name
-- File name mode --
File name mode:Take
--DefaultSceneTake--
Scene name:
[SCENE ]
Take number:[001]
```

Example of selecting a menu item without ">"

The current setting starts flashing and you can make setting on this screen.

```
M>SYS>
Default file name>
Select input:Analog
Record FS/bit:44k/16
Record CH. :Stereo
Record mode :Normal
MAX. file length:4G
↓
M>SYS>Select input
Default file name>
Select input:Analog
Record FS/bit:44k/16
Record CH. :Stereo
Record mode :Normal
MAX. file length:4G
Flashing
```

For details about each menu item, see the next pages.

<Memo>: Pressing the [EXIT] key goes back to the previous level in the menu. Therefore, pressing the [EXIT] key repeatedly exit the MENU mode. You can exit the MENU mode by a single press of the [STOP] key.

<Memo>: When you connect a USB keyboard, you can operate the SYSTEM SETUP menu from the keyboard.

Setting a file name

You can set the default file name which is given to an audio file created when recording.

The file name mode can be selected from "date/time" (of the internal clock), "scene name + take number" and "reel number + file number".

• Setting the file name mode

By highlighting "Default file name" on the SYSTEM SETUP menu screen and pressing the [ENTER] key, the display shows the next level screen.

```
M>SYS>
  ▾Default file name▸
  Select input: Analog
  Record FS/bit: 44k/16
  Record CH. : Stereo
  Record mode : Normal
  MAX. file length: 4G

M>SYS>Def. file name
-- File name mode --
File name mode: Take
--DefaultSceneTake--
Scene name:
[SCENE ]
Take number: [001]
```

By pressing the [ENTER] key again, the current setting of the "File name mode" item starts flashing and you can now make setting.

Use the [MENU] dial to select the mode and press the [ENTER] key. By default, "Take" is selected. The other available modes are "Date" and "Reel".

```
M>SYS>Def. file name
-- File name mode --
File name mode: Take
--DefaultSceneTake--
Scene name:
[SCENE ]
Take number: [001]
```

Take	<p>"<SCENE NAME>+<TAKE NUMBER>" (with ".wav", the file extension) is the file name. The take number is incremented automatically each time recording is made.</p> <p>Example: Scene-001.wav, Scene-002.wav</p>
Date	<p>The file name reflects the internal realtime clock data.</p> <p>Example: B05h 05m 06s 10aug 2008.wav</p>
Reel	<p>The reel number of a current storage device (Volume Label) with the file number is the default file name.</p> <p>Example: 10082008_005.wav,</p>

• Setting the scene name and take number

By using the [MENU] dial to highlight "Scene Name" and pressing the [ENTER] key, you can edit the scene name. You can give a scene name with up to 18 characters.

Use the [◀◀] and [▶▶] keys to move the cursor and use the [MENU] dial to select a desired alphanumeric character at the cursor point. You can also edit a name using a USB keyboard connected to the unit.

```
M>SYS>Def. file name
-- File name mode --
File name mode: Take
--DefaultSceneTake--
Scene name:
[SCENE ]
Take number: [001]

M>SYS>Def. file name
-- File name mode --
File name mode: Take
--DefaultSceneTake--
Scene name:
[SCENE ]
Take number: [001]
```

After editing the scene name, pressing the [ENTER] key fixes editing and you can now enter the take number (by default, "001" is set).

```
M>SYS>Def. file name
-- File name mode --
File name mode: Take
--DefaultSceneTake--
Scene name:
[SCENE ]
Take number: [001]
```

Use the [MENU] dial to select the take number between 001 and 999 and press the [ENTER] key to confirm the selection.

<Memo>: When setting the file name mode to "Take", the specified scene name and take number are used for each file name. The scene name and take number currently set are also used as the scene data or take data in the meta data regardless of the file name mode.

To exit the [MENU] mode, press the [STOP] key (or the [EXIT] key).

Selecting the input source

You can select the input source to analog or digital. The setting is stored to the internal flash ROM.

By using the [MENU] dial to highlight "Select input" in the SYSTEM SETUP menu and pressing the [ENTER] key, the current setting starts flashing and you can now select the input source (the default setting is "Analog").

Use the [MENU] dial to select "Analog" or "Digital" and press the [ENTER] key to confirm the setting.

```
M|SYS|
Default file name▶
Select input:Analog
Record FS/bit:44k/16
Record CH. :Stereo
Record mode :Normal
MAX. file length:4G
```

```
M|SYS|Select input
Default file name▶
Select input:Analog
Record FS/bit:44k/16
Record CH. :Stereo
Record mode :Normal
MAX. file length:4G
```

Flashing

Analog	The input source is set to the signal received from the [ANALOG INPUT] (balanced or unbalanced) connectors.
Digital	The input source is set to the signal received from the [DIGITAL INPUT] connector.

To exit the [MENU] mode, press the [STOP] key (or the [EXIT] key).

<Memo>: The selected input source is shown on the Home screen as "ANA" or "DIG".
When pressing the [MIC IN] key to activate the [MIC IN] connector, "MIC" is shown instead of "ANA" or "DIG".

Selecting the FS and bit

You can select the sampling frequency and quantization bit for recording. The setting is stored to the internal flash ROM.

By using the [MENU] dial to highlight "Record FS/bit" in the SYSTEM SETUP menu and pressing the [ENTER] key, the current setting starts flashing and you can now set the FS/bit combination (the default setting is "44k/16").

Use the [MENU] dial to select the desired option and press the [ENTER] key to confirm the setting.

```
M|SYS|
Default file name▶
Select input:Analog
Record FS/bit:44k/16
Record CH. :Stereo
Record mode :Normal
MAX. file length:4G
```

```
M|SYS|Record FS/bit
Default file name▶
Select input:Analog
Record FS/bit:44k/16
Record CH. :Stereo
Record mode :Normal
MAX. file length:4G
```

Flashing

The available options are 44k/16, 48k/16, 44k/24, 48k/24, 88k/24 and 96k/24.

<Note>: The FS/bit set by this item is applied when you make recording. Therefore, when you record a digital source which has different FS/bit, the pitch may change.
To avoid this problem, make sure that the "Record FS/bit" menu item matches the FS/bit of the input source.

To exit the [MENU] mode, press the [STOP] key (or the [EXIT] key).

<Memo>: The current FS/bit setting is shown on the Home screen when the unit is in the input monitor mode (i.e. record ready mode).

Selecting stereo or mono recording mode

You can select stereo or mono recording mode. The setting is stored to the internal flash ROM.

By using the [MENU] dial to highlight "Record CH." in the SYSTEM SETUP menu and pressing the [ENTER] key, the current setting starts flashing and you can now select stereo or mono (the default setting is "Stereo").

Use the [MENU] dial to select the desired option and press the [ENTER] key to confirm the setting.

```

M>SYS>
Default file name▶
Select input:Analog
Record FS/bit:44k/16
◀Record CH. :Stereo
Record mode :Normal
MAX. file length:4G
    
```

↓

```

M>SYS>Record CH.
Default file name▶
Select input:Analog
Record FS/bit:44k/16
Record CH. :Stereo
Record mode :Normal
MAX. file length:4G
    
```

Flashing

To exit the [MENU] mode, press the [STOP] key (or the [EXIT] key).

<Memo>: Depending on the selection, the Home screen looks like below.

```

0 h 00 m 00 FILE
A001 ABCDEFG.wav s00f
BWF 48/24 SINGLE
-60 40 30 20 12 8 6 4 2 0P
L
R
    
```

<When "Stereo" is selected (default)>

```

0 h 00 m 00 FILE
A001 ABCDEFG.wav s00f
BWF 48/24 SINGLE
-60 40 30 20 12 8 6 4 2 0P
M
MONO
    
```

<When "Mono" is selected>

Setting the maximum file length

You can select the maximum length (capacity) for recording.

When you import a file to a computer, the maximum file length may be limited by the computer. Therefore you should set the maximum length of a file recorded by the unit appropriately.

The maximum length of a file recorded by the unit can be set to 4 GB (default) or 2 GB.

The setting is stored to the internal flash ROM.

By using the [MENU] dial to highlight "Max. file length" in the SYSTEM SETUP menu and pressing the [ENTER] key, the current setting starts flashing and you can now select the maximum length of a file (the default setting is "4G").

```

M>SYS>
Record FS/bit:44k/16
Record CH. :Stereo
Record mode :Normal
◀MAX. file length:4G
Peak hold time:3sec
REF. level :-20dB
    
```

↓

```

M>SYS>MAX. file length
Record FS/bit:44k/16
Record CH. :Stereo
Record mode :Normal
MAX. file length:4G
Peak hold time:3sec
REF. level :-20dB
    
```

Flashing

<Note>: When you use a storage device whose recording capacity is smaller than the setting above, the maximum file length is limited by the capacity of the device.

To exit the [MENU] mode, press the [STOP] key (or the [EXIT] key).

Setting the peak hold time

You can set the peak hold time of the level meters between 0 and 9 seconds in one second steps. By default, it is set to three seconds. The setting is stored to the internal flash ROM.

By using the [MENU] dial to highlight "Peak hold time" in the SYSTEM SETUP menu and pressing the [ENTER] key, the current setting starts flashing and you can now select the peak hold time (the default setting is "3sec").

Use the [MENU] dial to select a desired time between 0 and 9 seconds and press the [ENTER] key to confirm the setting.

```

M>SYS▶
Record mode :Normal
MAX. file length:4G
▶Peak hold time:3sec
REF. level :-20dB
Cue monitor out :ALL
Digital out :AES/EBU
    
```

↓

```

M>SYS▶Peak hold time
Record mode :Normal
MAX. file length:4G
Peak hold time:8sec
REF. level :-20dB
Cue monitor out :ALL
Digital out :AES/EBU
    
```

Flashing

To exit the [MENU] mode, press the [STOP] key (or the [EXIT] key).

Setting the reference level

You can set the analog reference level. By default, the reference level is set to the "-20 dB" which is 20dB below the digital full scale level. You can set it to "-12 dB" if required. The setting is stored to the internal flash ROM.

By using the [MENU] dial to highlight "REF. level" in the SYSTEM SETUP menu and pressing the [ENTER] key, the current setting starts flashing and you can now select the reference level (the default setting is "-20dB").

Use the [MENU] dial to select a desired reference level between "-20dB" and "-12dB", and press the [ENTER] key to confirm the setting.

```

M>SYS▶
Record mode :Normal
MAX. file length:4G
Peak hold time:3sec
▶REF. level :-20dB
Cue monitor out :ALL
Digital out :AES/EBU
    
```

↓

```

M>SYS▶REF. level
Record mode :Normal
MAX. file length:4G
Peak hold time:3sec
REF. level :-20dB
Cue monitor out :ALL
Digital out :AES/EBU
    
```

Flashing

To exit the [MENU] mode, press the [STOP] key (or the [EXIT] key).

<Memo>: The reference level is shown in inverse video on the level meter scale (see below).

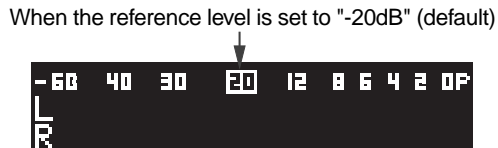
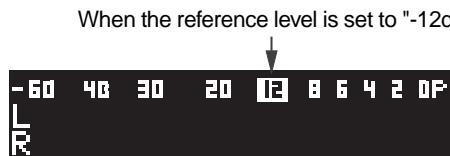

Setting cue monitor output destination

You can select the output destination of the playback audio while cueing.

By default, cue playback audio is output from the [ANALOG OUT], [DIGITAL OUT] and [PHONES] connectors. It is also possible to output cue playback audio only from the [PHONES] connector. The setting is stored to the internal flash ROM.

By using the [MENU] dial to highlight "Cue monitor out" in the SYSTEM SETUP menu and pressing the [ENTER] key, the current setting starts flashing and you can now select the destination (the default setting is "ALL").

Use the [MENU] dial to select the destination between "ALL" and "HP", and press the [ENTER] key to confirm the setting.

```

M>SYS>
Peak hold time:3sec
REF. level :-20dB
#Cue monitor out :ALL
Digital out :AES/EBU
Display INV. :Off
Keyboard type:US
    
```

↓

```

M>SYS>Cue monitor out
Peak hold time:3sec
REF. level :-20dB
Cue monitor out :ALL
Digital out :AES/EBU
Display INV. :Off
Keyboard type:US
    
```

Flashing

ALL	Cue playback audio is output from the [ANALOG OUT], [DIGITAL OUT] and [PHONES] connectors.
HP	Cue playback audio is output from the [PHONES] connector.

To exit the [MENU] mode, press the [STOP] key (or the [EXIT] key).

Setting the output digital signal format

You can select the format of the digital signal output from the [DIGITAL OUTPUT] connector.

By default, it is set to "AES/EBU" and the digital signal conformed to the IEC 60958 (AES/EBU) format is output. It is also possible to output the digital signal conformed to the IEC 60958 (S/P DIF). The setting is stored to the internal flash ROM.

By using the [MENU] dial to highlight "Digital out" in the SYSTEM SETUP menu and pressing the [ENTER] key, the current setting starts flashing and you can now select the digital signal format (the default setting is "AES/EBU").

Use the [MENU] dial to select the format between "AES/EBU" and "SPDIF", and press the [ENTER] key to confirm the setting.

```

M>SYS>
Peak hold time:3sec
REF. level :-20dB
Cue monitor out :ALL
#Digital out :AES/EBU
Display INV. :Off
Keyboard type:US
    
```

↓

```

M>SYS>Digital out
Peak hold time:3sec
REF. level :-20dB
Cue monitor out :ALL
Digital out :AES/EBU
Display INV. :Off
Keyboard type:US
    
```

Flashing

AES/EBU	Outputs the digital signal conformed to the IEC 60958 (AES/EBU) format.
SPDIF	Outputs the digital signal conformed to the IEC 60958 (S/P DIF) format.

To exit the [MENU] mode, press the [STOP] key (or the [EXIT] key).

Setting the USB keyboard type

When you connect a USB keyboard to the [USB (KYBD ONLY)], select the USB keyboard type ("US" or "JAPAN") correctly. The setting is stored to the internal flash ROM.

By using the [MENU] dial to highlight "Keyboard type" in the SYSTEM SETUP menu and pressing the [ENTER] key, the current setting starts flashing and you can now select the keyboard type (the default setting is "US").

Use the [MENU] dial to select the type between "US" and "JAPAN", and press the [ENTER] key to confirm the setting.

```

M>SYS▶
Cue monitor out :ALL
Digital out :AES/EBU
Display INU. :Off
▶Keyboard type:US
SYS. user save▶
SYS. user load▶

M>SYS▶Keyboard type
Cue monitor out :ALL
Digital out :AES/EBU
Display INU. :Off
Keyboard type:US
SYS. user save▶
SYS. user load▶
    
```

Flashing

US	Select when you connect a US keyboard.
JAPAN	Select when you connect a Japanese keyboard.

To exit the [MENU] mode, press the [STOP] key (or the [EXIT] key).

Saving system memory data

You can save system memory data which contains settings in the SYSTEM SETUP menu, PLAY SETUP menu, etc. to the internal flash ROM or the current storage device. See the next page for the data to be saved.

The saved data can be loaded to the UR-2 so you can apply the same system settings to multiple UR-2 units, or you can apply the desired system settings by loading a set of typical settings.

By using the [MENU] dial to highlight "SYS. user save" in the SYSTEM SETUP menu and pressing the [ENTER] key, the display shows the screen for selecting the destination.

```

M>SYS▶
Digital out :AES/EBU
Display INU. :Off
Keyboard type:US
▶SYS. user save▶
SYS. user load▶
SYS. default set▶

M>SYS▶Sys user save
-Select save device-
Internal FROM ▶
Current device▶
    
```

Internal FROM	Data is saved to the internal Flash ROM.
Current device	Data is saved to the current storage device (SD1, SD2 or USB).

By using the [MENU] dial to select "Internal FROM" or "Current device" and pressing the [ENTER] key, the following screen appears. Pressing the [ENTER] key again executes the save operation. (The following shows the screen example when selecting "Internal FROM".)

```

M>SYS▶Sys user save
Save to FROM
Over write
user system memories
Are you sure? ← Flashing
Yes: ENTER Key
No : EXIT Key
    
```

After finishing the save operation, "Completed" is shown. See the table in the next page for the contents of the data to be saved.

To exit the [MENU] mode, press the [STOP] key (or the [EXIT] key).

The following shows the contents of the data to be saved.

• **SYSTEM SETUP menu**

- (1) File name mode (2) Selet input
- (3) Record FS/bit (4) Record CH.
- (5) Record mode (6) Max. file length
- (7) Peak hold time (8) REF. level
- (9) Cue monitor out (10) Digital out
- (11) Display INV. (12) Keyboard type

• **PLAY SETUP menu**

- (1) Play mode (2) Repeat
- (3) Auto play (4) PowerOn Play
- (5) Mono mix

• **MIC IN SETUP menu**

- (1) Mic in (2) Switch hold
- (3) Play ATT. (4) Mic record
- (5) Phantom

• **REMOTE SET menu**

- (1) Remote sel. (2) Parallel setup
- (3) RE232C setup

• **Display brightness level**

<Note>: After the software is upgraded, setting data which has been saved to the current device (SD card or USB memory) with the older software version may be unusable.

Loading the system memory data

You can load system memory data saved by using the "SYS. user save" item in the SYSTEM SETUP menu (see the previous page for the "SYS. user save" item).

By using the [MENU] dial to highlight "SYS. user load" in the SYSTEM SETUP menu and pressing the [ENTER] key, the display shows the screen for selecting the loading source (the internal flash ROM or the current storage device).

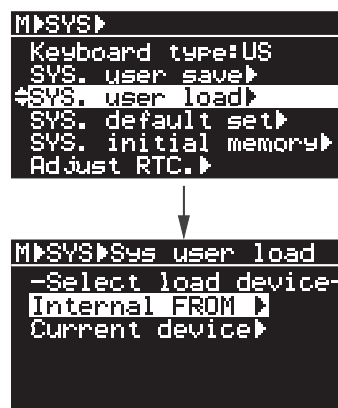

Internal FROM	Data is loaded from the internal Flash ROM.
Current device	Data is loaded from the current storage device (SD1, SD2 or USB).

By using the [MENU] dial to select "Internal FROM" or "Current device" and pressing the [ENTER] key, the following screen appears. Pressing the [ENTER] key again executes the load operation. (The following shows the screen example when selecting "Internal FROM".)

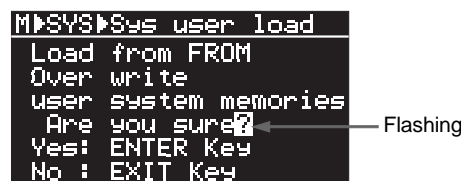

After finishing the load operation, "Completed" is shown.

To exit the [MENU] mode, press the [STOP] key (or the [EXIT] key).

Initializing the setup data

You can initialize the system memory in the SYS SETUP and PLAY SETUP menus to the factory default conditions.

By using the [MENU] dial to highlight "SYS. default set" in the SYSTEM SETUP menu and pressing the [ENTER] key, the display shows the confirmation screen for executing initialization.

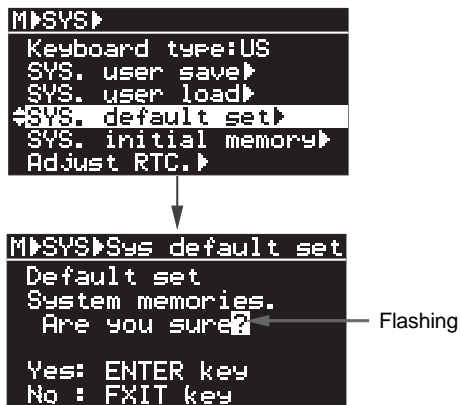

To execute initialization, press the [ENTER] key. To cancel initialization, press the [EXIT] key. After initialization finishes, the display returns to the previous screen.

To exit the [MENU] mode, press the [STOP] key (or the [EXIT] key).

The following shows the contents of the data to be initialized.

• **SYSTEM SETUP menu**

- (1) File Name mode (2) Select input
- (3) Record FS/bit (4) Record CH.
- (5) Record mode (6) Max. file length
- (7) Peak hold time (8) REF. level
- (9) Cue monitor out (10) Digital out
- (11) Display INV. (12) Keyboard type

• **PLAY SETUP menu**

- (1) Play mode (2) Repeat
- (3) Auto play (4) PowerOn Play
- (5) Mono mix

• **MIC IN SETUP menu**

- (1) Mic in (2) Switch hold
- (3) Play ATT. (4) Mic record
- (5) Phantom

• **REMOTE SET menu**

- (1) Remote sel. (2) Parallel setup
- (3) RS232C setup

• **Other data**

- Display brightness

Initializing flash memory

You can initialize flash memory data (including all system memory, chain play list and storage device information) to the factory default conditions.

By using the [MENU] dial to highlight "SYS. Initial memory" in the SYSTEM SETUP menu and pressing the [ENTER] key, the display shows the confirmation screen for executing initialization.

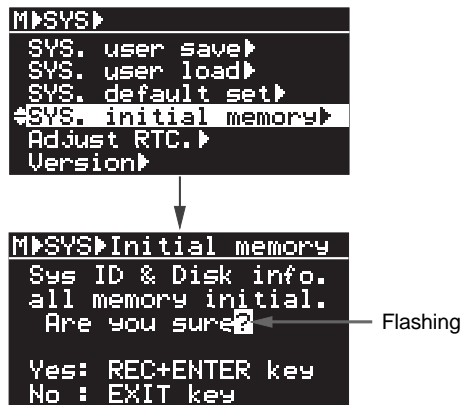

To execute initialization, press the [ENTER] key while holding down the [REC] key. To cancel initialization, press the [EXIT] key. After initialization finishes, the display returns to the previous screen.

To exit the [MENU] mode, press the [STOP] key.

The following shows the contents of the data to be initialized.

• **SYSTEM SETUP menu**

- (1) File name mode (2) Select input
- (3) Record FS/bit (4) Record CH.
- (5) Record mode (6) Max. file length
- (7) Peak hold time (8) REF. level
- (9) Cue monitor out (10) Digital out
- (11) Display INV. (12) Keyboard type

• **PLAY SETUP menu**

- (1) Play mode (2) Repeat
- (3) Auto play (4) PowerOn Play
- (5) Mono mix

• **MIC IN SETUP menu**

- (1) Mic in (2) Switch hold
- (3) Play ATT. (4) Mic record
- (5) Phantom

• **REMOTE SET menu**

- (1) Remote sel. (2) Parallel setup
- (3) RS232C setup

• **Other data**

- (1) Display brightness (2) User memories (Int. FROM)

Checking the system version

You can check the system version.

<Note>: You can check the latest software version of the unit via the Fostex website. If you find the software upgrade file on the website, download it and upgrade your unit. For the details about how to upgrade the unit, see "Upgrading the UR-2" on page 69.
If you cannot download the software upgrade file from the Fostex website, contact your local Fostex dealer or sales office.

By using the [MENU] dial to highlight "Version" in the SYSTEM SETUP menu and pressing the [ENTER] key, the display shows the system version.

```
M|SYS|
SYS. user save|
SYS. user load|
SYS. default set|
SYS. initial memory|
Adjust RTC.|
^Version|
```

↓

```
M|SYS|Version
---Main version---
Ver1.00 30/AUG/'08
```

To exit the [MENU] mode, press the [STOP] key (or the [EXIT] key).

STORAGE UTILITY menu details

The STORAGE UTILITY menu consists of seven menu items including file name editing, file copy, file delete, etc.

Menu item	Description
Edit file name	You can edit and save a name of the recorded file. The file name that you can edit is the one included in the current storage device.
File info.	You can see the file information of the file included in the current storage device.
File copy	You can copy a file (or all files) on a storage device to another storage device.
Delete file	You can delete a file on the current storage device.
Report file list	You can create a CSV (Comma Separated Value) file which contains information of all files on the current storage device. In this file, each value is separated by comma so you can open and edit it using a spreadsheet software application.
Card all erase	You can erase all data on current the storage device.
Vol. Label	You can edit a volume label of the current storage device.

Basic operation of STORAGE UTILITY menu

- (1) While the unit is stopped, press the [ENTER] key to enter the MENU mode.

```

MENU▶
SYSTEM SETUP ▶
PLAY SETUP ▶
STORAGE UTILITY▶
FILE SEL ▶
STORAGE SEL ▶
MIC IN SETUP ▶
    
```

- (2) Use the [MENU] dial to highlight "STORAGE UTILITY" and press the [ENTER] key.
The STORAGE UTILITY menu screen is shown.

```

MENU▶
SYSTEM SETUP ▶
PLAY SETUP ▶
STORAGE UTILITY▶
FILE SEL ▶
STORAGE SEL ▶
MIC IN SETUP ▶
    
```

↓

```

M▶STORAGE:A▶
Edit file name ▶
File info. ▶
File copy ▶
Delete file ▶
Report file list▶
Card all erase ▶
    
```

- (3) Use the [MENU] dial to select a desired menu item and press the [ENTER] key.

The display shows the screen of the menu item.

The following shows the screen example which appears when you select "Edit file name".

```

M▶ST▶Edit file name
---EDIT FILE NAME---
File No:001
[SCENE_001].wav
    
```

Flashing

See the next pages for details of each menu item.

<Memo>: Pressing the [EXIT] key returns to the previous menu level. Therefore, pressing the key repeatedly exits the MENU mode. You can also exit the MENU mode by a single press of the [STOP] key.

<Memo>: You can operate the menu by using a USB keyboard.

Editing a file name

You can edit the file name of a file.

In the following procedure, it is assumed that the STORAGE UTILITY menu screen is shown.

<Note>: You can only edit the file name of the current file. Before entering the MENU mode, select a desired file of which you want to edit the file name.

- (1) While "Edit file name" is highlighted, press the [ENTER] key.

The display changes to show the screen for editing the file name of the current file.

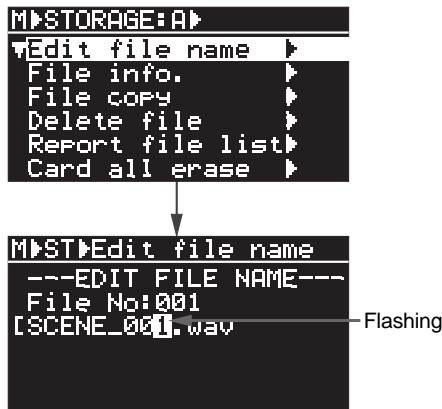

- (2) Edit the file name. Use the [◀] and [▶] keys to select the editing (flashing) point and use the [MENU] dial to enter the desired alphanumeric character. You can also edit the file name using a USB keyboard.

- (3) After finishing editing, press the [ENTER] key to confirm.

The display returns to the Home screen.

<Memo>: The edited file name is separated to "fSCENE" and "fTAKE" and stored to the "Description" field in the BEXT chunk. <SCENE> and <TAKE> in the iXML Chunk are also updated.

Viewing the file information

You can view the file information of the current file.

In the following procedure, it is assumed that the STORAGE UTILITY menu screen is shown.

<Note>: You can only view the file information of the current file. Before entering the MENU mode, select a desired file of which you want to view the information.

- (1) Use the [MENU] dial to highlight "File Info.", press the [ENTER] key.

The display shows the file information including the FS/bit, recording date and time, duration and volume.



- (2) To dismiss the file information screen, press the [STOP] key to exit the MENU mode.

Copying files

You can copy any desired files on the current storage device (SD card or USB memory) to another storage device (SD card or USB memory).

The following shows the procedure for copying files from an SD card to a USB memory. It is assumed that the SD card is set to the SD-1 slot and selected as the current storage device, while the display shows the STORAGE UTILITY menu.

<Note>: Do not unplug the power cable (of the AC adaptor or external battery) or remove the storage device from the unit during file copy.

- (1) Use the [MENU] dial to highlight "File copy" and press the [ENTER] key.

The display shows the file list of the current storage device (in this procedure example, the SD card is set to the SD-1 slot).

```
M>ST>F COPY>SD1>>>SD2
Edit file name  ▶
File info.     ▶
File copy      ▶
Delete file    ▶
Report file list▶
Card all erase ▶
```

```
M>ST>F COPY>SD1>>>SD2
[FN] [NAME]
001 SCENE_001.wav
002 SCENE_002.wav
003 SCENE_003.wav
004 SCENE_004.wav
005 SCENE_005.wav
```

- (2) Use the [MENU] dial to highlight a copy source file and press the [ENTER] key.

A checkmark is added to the left of the selected file.

By repeating this step, you can add checkmarks to multiple files.

Pressing the [◀◀] key moves up to the first entry in the list, while pressing the [▶▶] key moves down to the last entry in the list.

```
M>ST>F COPY>SD1>>>SD2
[FN] [NAME]
✓001 SCENE_001.wav
002 SCENE_002.wav
003 SCENE_003.wav
004 SCENE_004.wav
005 SCENE_005.wav
```

<Memo>: By highlighting "<All Select>" at the bottom of the file list, you can add checkmarks to all the files.

```
M>ST>F COPY>SD1>>>SD2
[FN] [NAME]
✓006 SCENE_006.wav
✓007 SCENE_007.wav
◀◀All Select>
Destination :SD2
[EXECUTE]:
```

<Note>: If you want to copy all files in the chain play list (CHAINLIST.CSV) or in the timer play list (TIMERLIST.CSV) in the copy source storage device, it is recommended to select "<All Select>". If any file in the list is not copied, you cannot correctly execute chain list play or timer play with the copy destination storage device.

- (3) Use the [MENU] dial to highlight "Destination" below "<All Select>" and press the [ENTER] key. You can now select the copy destination.

```
M>ST>F COPY>SD1>>>SD2
[FN] [NAME]
✓006 SCENE_006.wav
✓007 SCENE_007.wav
◀◀All Select>
◀◀Destination :SD2
[EXECUTE]:
```

```
M>ST>F COPY>SD1>>>SD2
[FN] [NAME]
✓006 SCENE_006.wav
✓007 SCENE_007.wav
◀◀All Select>
Destination :SD2
[EXECUTE]:
```

Flashing

- (4) Use the [MENU] dial to select "USB" and press the [ENTER] key.

```
M>ST>F COPY>SD1>>>SD2
[FN] [NAME]
✓006 SCENE_006.wav
✓007 SCENE_007.wav
◀◀All Select>
Destination :USB
[EXECUTE]:
```

Flashing

```
M>ST>F COPY>SD1>>>USB
[FN] [NAME]
✓006 SCENE_006.wav
✓007 SCENE_007.wav
◀◀All Select>
Destination :USB
[EXECUTE]:
```

<Note>: If you attempt to select a copy destination which does not have enough space to accept the copy source files, the popup window as below appears and you cannot select the destination.

```

Error!
Destinaton
Over copy size
    
```

- (5) Use the [MENU] dial to highlight "[EXECUTE]" and press the [ENTER] key.

The unit starts file copy from the SD card on the SD1 slot to the USB memory. After finishing file copy, the popup window as below appears and stop accessing.

```

M>ST>F COPY>SD1>>>USB
[FN] [NAME]
✓006 SCENE_006.wav
✓007 SCENE_007.wav
<All Select>
Destination :USB
▲[EXECUTE]:
    
```

```

M>ST>F COPY
SD1 >>>> USB
Finish time :12M05S
Remain size : 345MB
0 50 100%
    
```

```

M>ST>F COPY
Completed!
Pls hit any keys
    
```

- (6) Press any key to exit the MENU mode.

Deleting a file

You can delete a file on the current storage device.

In the following procedure, it is assumed that the display shows the STORAGE UTILITY menu.

<Note>: When you delete a file, the remaining space does not increase unless you turn off and on the power or remove and set the storage device.

- (1) Use the [MENU] dial to highlight "Delete file" and press the [ENTER] key.

The display shows the file list of the current storage device.

```

M>STORAG:A▶
Edit file name ▶
File info. ▶
File copy ▶
◀Delete file ▶
Report file list▶
Card all erase ▶
    
```

```

M>ST▶Delete file
[NO] [NAME]
✓001 SCENE_001.wav
002 SCENE_002.wav
003 SCENE_003.wav
004 SCENE_004.wav
005 SCENE_005.wav
    
```

- (2) Use the [MENU] dial to highlight a file you want to delete and press the [ENTER] key.

The display shows the popup window as below.

```

-Delete file:A002-
Are you sure? ← Flashing
Yes:REC+ENTER key
    
```

- (3) Press the [ENTER] key while holding down the [REC] key.

The selected file is deleted and the display returns to show the file list. The files below the deleted file in the list moves up.

- (4) Press the [STOP] key to exit the MENU mode.

Erasing all data on the storage device

You can erase all data on a storage device (an SD card or a USB memory) set to the unit. If more than one storage device is set to the unit, you can select the device of which you erase all data.

In the following procedure, it is assumed that the display shows the STORAGE UTILITY menu.

- Use the [MENU] dial to highlight "Card all erase" and press the [ENTER] key.

The display shows the second layer of the "Card all erase" screen.

If you execute step (2) below in the default condition, all data on the current storage device is erased.

On this screen, you can select a storage device of which you delete data as well as edit the volume label, as described below.



Selecting the storage device

By using the [MENU] dial to select "Storage" and pressing the [ENTER] key, you can select the desired storage device. Note that you cannot select a storage device which is not set to the unit.

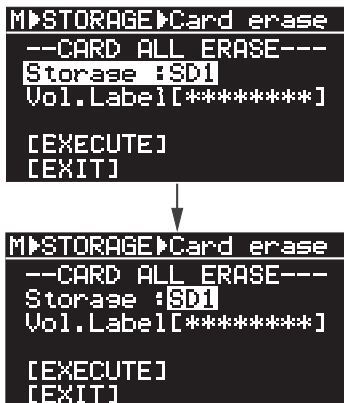

Use the [MENU] dial to select the desired storage and press the [ENTER] key to confirm.

Changing the volume label

By using the [MENU] dial to select "Vol. Label" and pressing the [ENTER] key, you can change the desired volume label.

Use the [◀◀] and [▶▶] keys to select the editing (flashing) point and use the [MENU] dial to enter the desired alphanumeric character. You can also edit the file name using a USB keyboard.



After finishing editing, press the [ENTER] key to confirm.

<Note>: You can also edit the volume label after deleting data of the storage device. See "Editing the volume label" described later.

- Use the [MENU] dial to highlight "[EXECUTE]" and press the [ENTER] key.

The display shows the caution screen, where "Are you sure?" is flashing.



- Press the [ENTER] key while holding down the [REC] key.

The unit immediately deletes the data and the display returns to the Home screen, showing no data is recorded.

Editing the volume label

You can edit the volume label of the current storage device.

In the following procedure, it is assumed that the display shows the STORAGE UTILITY menu.

- Use the [MENU] dial to highlight "Volume Label" and press the [ENTER] key.
The rightmost position of the volume label starts flashing and you can now edit the label.

```
M>STORAGE:A>
File info.      ▶
File copy      ▶
Delete file    ▶
Report file list▶
Card all erase ▶
▲Vol.Label:[*****]
```

```
M>STORAGE:A>Vol.Label
File info.      ▶
File copy      ▶
Delete file    ▶
Report file list▶
Card all erase ▶
Vol.Label:[*****]
```

Flashing

- Edit the volume label by using the [◀◀] and [▶▶] keys to select the editing (flashing) point and using the [MENU] dial to enter the desired alphanumeric character.
After editing, press the [ENTER] key to confirm. You can also edit the file name using a USB keyboard.
- Press the [STOP] key to exit the MENU mode.

Creating a file information file in CSV format

You can create the CSV (comma separated value) file which includes the information of all files recorded on the current storage device. Using this file, you can edit the chain play list or timer play list by using a spreadsheet software application.

In the following procedure, it is assumed that the display shows the STORAGE UTILITY menu.

- Use the [MENU] dial to highlight "Report file list" and press the [ENTER] key.
The display shows the screen as below, on which you can see the file name of the CSV file as well as flashing "?".

```
M>STORAG:A>
Edit file name ▶
File info.     ▶
File copy      ▶
Delete file    ▶
Report file list▶
Card all erase ▶
```

```
M>ST>Report file list
Product file name
list files.
[FILELIST.CSV]
Are you sure? ←Flashing
Yes :[ENTER] key
No  :[EXIT] key
```

- Press the [ENTER] key to creates the CSV file. (To cancel creating the file, press the [EXIT] key.)
The unit immediately create the CSV file ("FILELIST.CSV") in the current storage device.

```
M>ST>Report file list
Product file name
list files.
[FILELIST.CSV]
Completed
Pls hit any keys.
```

- Press any key to exit the MENU mode.

<Memo>: In the CSV file, the information includes the number, the file name, the start time, the end time, the sampling frequency (FS), the bit , channel, size and creation date, and is set as the example below.

<Example>

##FILE NO	File Name	S-TIME (h:m:s:f)	E-TIME (h:m:s:f)	FS	BIT	CH	Date##
1	sample1.wav	00:00:00:00	01:23:45:67	44100	16	2	20080901
2	sample2.wav	00:00:00:00	00:23:45:67	44100	16	1	20080905
3	sample3.wav	00:00:00:00	00:45:24:00	44100	24	2	20080915
4	sample4.wav	00:00:00:00	01:02:34:56	44100	24	2	20080920

Chain play list / Timer play list (examples)

A play list created using the “CHAIN PLAY SET” or “TIMER PLAY SET” menu of the MENU mode is saved in the CSV (Comma Separated Value) format. You can edit the play list by a computer using a spreadsheet software application or a text editor. The following shows examples of file lists shown on a spreadsheet software application or text editor.

<Chain play list file (file name: CHAINLIST.CSV)>

<Example> (shown on a spreadsheet software application)

```
##CHAIN PLAY LIST##
##UPDATE 2008/09/01
##FN File Name S-TIME(h:m:s:f) E-TIME(h:m:s:f) FS BIT CH
1 sample1.wav 00:00:00:00 01:23:45:67 44100 16 2
2 sample2.wav 00:00:00:00 00:23:45:67 44100 16 1
3 sample3.wav 00:00:00:00 00:45:24:00 44100 24 2
4 sample4.wav 00:00:00:00 01:02:34:56 44100 24 2
```

<Example> (shown on a text editor)

```
##CHAIN PLAY LIST##
##UPDATE 2008/09/01 18: 28
##FN, File Name, S-TIME (h:m:s:f), E-TIME (h:m:s:f), FS, BIT, CH
1, sample1.wav, 00:00:00:00, 01:23:45:67, 44100, 16, 2
2, sample2.wav, 00:00:00:00, 00:23:45:67, 44100, 16, 1
3, sample3.wav, 00:00:00:00, 00:45:24:00, 44100, 24, 2
4, sample4.wav, 00:00:00:00, 01:02:34:56, 44100, 24, 2
```

<Timer play list file (file name: TIMERLIST.CSV)>

<Example> (shown on a spreadsheet software application)

```
##TIMER PLAY LIST##
##UPDATE 2008/09/01 18:18
##TN File Name S-TIME(h:m:s:f) E-TIME (h:m:s:f) FS BIT CH TIMER(h:m) SUN MON TUE WED THU FRI SAT
1 sample1.wav 00:00:00:00 01:23:45:67 44100 16 2 11:10 ON ON ON ON ON ON ON
2 sample2.wav 00:00:00:00 00:23:45:67 44100 16 1 12:00 ON ON ON ON ON ON ON
3 sample3.wav 00:00:00:00 00:45:24:00 44100 24 2 12:10 OFF ON ON ON ON ON OFF
4 sample4.wav 00:00:00:00 01:02:34:56 44100 24 2 13:10 OFF ON ON ON ON ON OFF
```

<Example> (shown on a text editor)

```
##TIMER PLAY LIST##, , ,
##UPDATE 2008/09/01 18:18
##TN, File Name, S-TIME(h:m:s:f), E-TIME (h:m:s:f), FS, BIT, CH, TIMER(h:m), SUN, MON, TUE, WED, THU, FRI, SAT
1, sample1.wav, 00:00:00:00, 01:23:45:67, 44100, 16, 2, 11:10, ON, ON, ON, ON, ON, ON, ON
2, sample2.wav, 00:00:00:00, 00:23:45:67, 44100, 16, 1, 12:00, ON, ON, ON, ON, ON, ON, ON
3, sample3.wav, 00:00:00:00, 00:45:24:00, 44100, 24, 2, 12:10, OFF, ON, ON, ON, ON, ON, OFF
4, sample4.wav, 00:00:00:00, 01:02:34:56, 44100, 24, 2, 13:10, OFF, ON, ON, ON, ON, ON, OFF
```

Main specifications

Inputs/outputs

* 0dBu = 0.775Vrms, 0dBV = 1Vrms

ANALOG INPUT (balanced)

Connectors	: XLR-3-31 type (pin2: hot)
Input impedance	: More than 10k Ω
Reference input level	: +4dBu
Maximum input level	: +24dBu

ANALOG INPUT (unbalanced)

Connectors	: RCA pin jack
Input impedance	: More than 10k Ω
Reference input level	: -10dBV
Maximum input level	: +10dBV

MIC INPUT (balanced)

Connectors	: XLR-3-31 type (pin2: hot)
Input impedance	: More than 1.5k Ω
Reference input level	: -56dBu (TRIM: Max.)
Maximum input level	: +7dBu (TRIM: Min.)
Mic power	: Phantom power (48V \pm 4V)

ANALOG OUTPUT (balanced)

Connectors	: XLR-3-32 type (pin2: hot)
Output load impedance	: More than 10k Ω
Reference output level	: +4dBu
Maximum output level	: +24dBu

ANALOG OUTPUT (unbalanced)

Connectors	: RCA pin jack
Output load impedance	: More than 10k Ω
Reference input level	: -10dBV
Maximum input level	: +10dBV

PHONES OUT

Connector	: 6mm dia stereo phone jack
Applicable load impedance	: More than 32 Ω
Maximum output level	: 100mW (at 32 Ω)

DIGITAL INPUT (balanced)

Connector	: XLR-3-31 type (pin2: hot)
Format	: IEC60958 (AES/EBU) or IEC60958 (S/P DIF), auto selection

DIGITAL OUTPUT (balanced)

Connector	: XLR-3-32 type (pin2: hot)
-----------	-----------------------------

Format	: IEC60958 (AES/EBU) or IEC60958 (S/P DIF), The format of an output signal is selected in the SYS SETUP menu of the MENU mode.
--------	---

PARALLEL REMOTE

Connector	: D-sub 25 pin (female)
-----------	-------------------------

RS232C

Connector	: D-sub 9 pin (female)
-----------	------------------------

USB (PC)

Connector	: USB 2.0 (Type B)
-----------	--------------------

USB (HOST)

Connector	: USB 2.0 (Type A)
-----------	--------------------

USB (KYBD ONLY)

Connector	: USB 1.1 (Type A)
-----------	--------------------

DC IN

Connector	: XLR-4-32 type
-----------	-----------------

FOOT SW

Connector	: 6mm dia phone jack
-----------	----------------------

Recording/playback

Recording medium	: SD (SDHC) card : USB memory
------------------	----------------------------------

File format	: BWF (Broadcast Wave Format)
-------------	-------------------------------

Sampling frequency/quantization

: 44.1 / 48kHz 16bit
: 44.1/48/88.2/96kHz 24 bit

Recording track	: STEREO, MONO
-----------------	----------------

R/P frequency response

LINE IN - OUT	: 20Hz~20kHz \pm 2dB (FS 44.1/ 48kHz)
	: 20Hz~40kHz \pm 3dB (FS 88.2/ 96kHz)

MIC IN - LINE OUT	: 20Hz~20kHz \pm 6dB (Typical)
-------------------	----------------------------------

Model UR-2 <Main specifications>

LINE IN - PHONES (at 32Ω, 50mW)
: 20Hz~20kHz +/-3dB (Typical)

S/N
LINE : 103dB (Typical)
MIC : 85dB (Typical)

Dynamic range : 103dB (Typical)

T. H. D.
LINE : Less than 0.006% (at 1kHz
-1dBFS Typical)
MIC : Less than 0.01% (at 1kHz
-1dBFS Typical)

Channel separation : More than 95dB (at 1kHz,
-1dBFS Typical)

Reference level : -12dBFS, -20dBFS
The reference level is selected in the SYS SETUP menu
of the MENU mode.

Cue point chunk : 99 par one file

General

Dimensions : 482 (W) x 44 (H) x 195 (D) mm

Weight : Approximately 2.3kg

Power source : DC12 ~ 24V
: AC adaptor (supplied)
: External battery (not supplied)

Power consumption : Approximately 5W

* Specifications and appearance are subject to change without notice for product improvement.

*  Logo is a trademark.

Physical dimensions

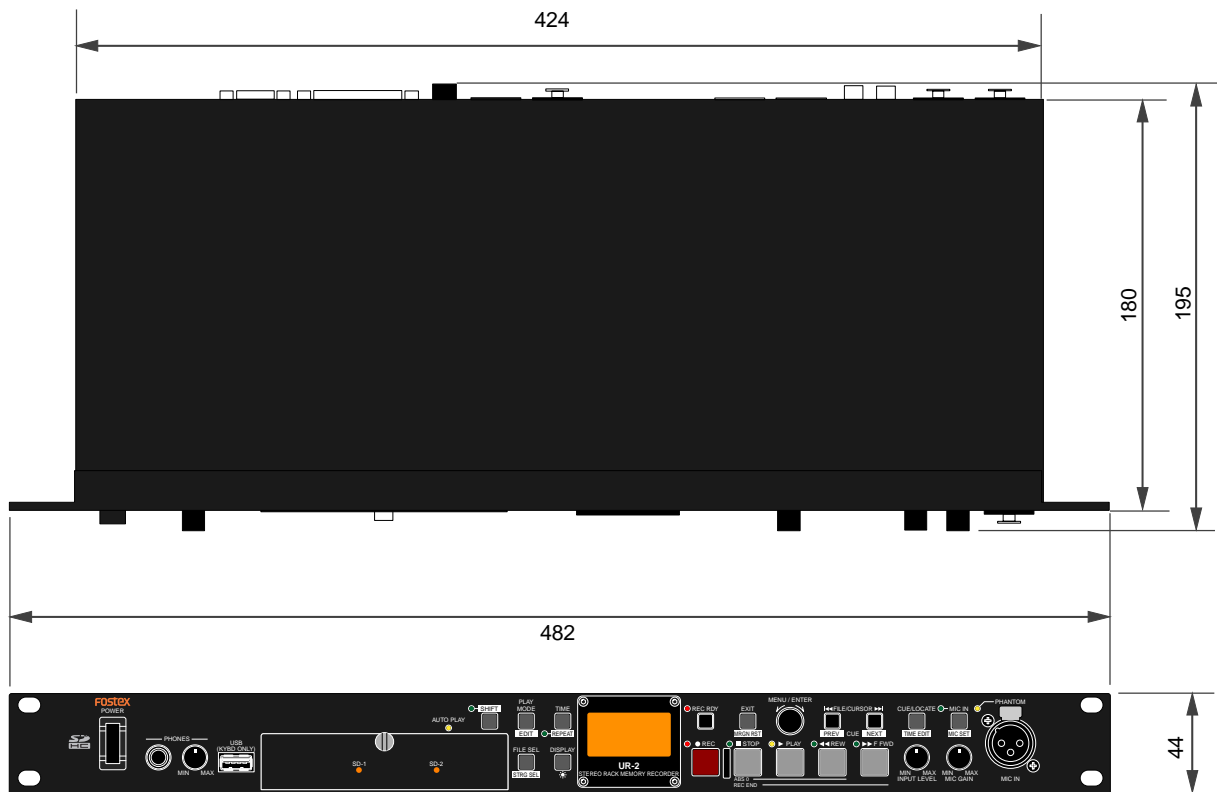

Index

<A>		<O>	
AES/EBU	77	Overview	12
All play	43	<P>	
Auto play	54, 57	Parallel remote	62
Attenuating playback level	40	Peak hold	76
		Playback position display	25
Brightness	24	Play back	41
<C>		Play mode	41, 56
Chain play	44, 46	Play list	46, 51, 88
Connection	21	Phantom power	32, 40
Command list	64	Power on play	55, 58
Connecting a computer to the unit	65	Precautions on installation	10
Controlling from an external device	61	Protection	66
CSV file format	47, 52	Protection of an SD card	66
Cueing function	54, 77	Protection cover	26
Current storage	26	<R>	
<D>		Rack mount	10
Date	73	Recording system	30
Default file name	31, 73	Recording time	30
Default setting	71	Recording source	31, 74
Deleting a file	85	Recording channels	31, 75
Digital recording	34	Recording	30
Digital scrub	49, 55	Recording level	33
Display	17	Removing a storage device	27
<E>		Reference level	33, 76
Eject	27	Reference marker	33, 76
End time	47, 53	Reel	73
Enlarged file name	25	Repeat	54, 57
Erasing all data on the storage device	86	Relay play	43
External microphone	38	Remain	34
<F>		RS232C	63
File copy	84	<S>	
File name	73, 83	Sampling frequency	31,
File information	83, 87	74	
File transfer	65	Saving system memory data	78
File format	30	Setting the output digital signal format	77
File number	17, 26	Setting a CUE point	35
Flash memory	80	Setup before you start recording	30
Format	11	Selecting a storage device	28
Folder	29	Shift mode	13
Front panel	13	Single play mode	42
<I>		Skip	59
Initializing the setup data	80	SPDIF	77
Initializing flash memory	80	Specifications	88
Input source	31, 74	Storage	26, 27, 28, 81
Input monitor	33	Start time	47, 53
Inserting a storage device	26	System memory	78
Internal clock	23	System version	81
Inversing the display	24	<T>	
<K>		Take	73
Keyboard	67, 78	Turning on the power	23
<L>		Timer play mode	45, 51
Level meter	17, 33	<U>	
Lithium battery	16	USB memory	26
Loading the system memory data	79	USB port	65, 67
Locate	59	Using a microphone for recording	34, 38
<M>		<V>	
Margin level	33	Version upgrade	11, 69
Maximum file size	31, 75	Volume label	86, 87
MENU mode	70		
Memory play	45		
Microphone	38		
Mono mix	58		
<N>			
Notes on moisture condensation	11		
Non shift mode	13		
Numeric keyboard	67		

Declaration of EC Directive

This equipment is compatible with the EMC Directive (89/336/EEC) - Directive on approximation of member nation's ordinance concerning the electromagnetic compatibility and with the Low Voltage Directive (73/23/EEC) - Directive on approximation of member nation's ordinance concerning electric equipment designed to be used within the specified voltage range.

The Affect of Immunity on This Equipment

The affect of the European Specification EN61000-6-1 (coexistence of electromagnetic waves - common immunity specification) on this equipment are as shown below.

In the electrical fast transient/burst requirements, surge, conducted disturbances by radio-frequency fields, power frequency magnetic field, radiate electromagnetic field requirements and static electricity discharging environment, this could be affected by generation of noise in some cases.

FOSTEX DISTRIBUTORS LIST IN EUROPE

* Including non-EU countries (as of March 2007)

<AUSTRIA>

NAME: ATEC Audio-u. Videogeraete VertriebsgesmbH.
ADD: Im Winkel 5, A-2325 Velm, Austria
TEL: (+43) 2234-74004, FAX: (+43) 2234-74074

<BELGIUM>

NAME: General Audio
ADD: Raymond Pelgrimslaan 101, B-1702 Groot-Bijgaarden, Belgium
TEL: (+32) 2-4630650, FAX: (+32) 2-4661500

<DENMARK>

NAME: SC Sound ApS
ADD: Malervej 2, DK-2630 Taastrup, Denmark
TEL: (+45) 4399-8877, FAX: (+45) 4399-8077

<FINLAND>

NAME: Norettron Oy Audio
ADD: P. O. Box 22, FIN-02631 Espoo, Finland
TEL: (+358) 9-5259330, FAX: (+358) 9-52593352

<FRANCE>

NAME: Sennheiser France
ADD: 128 bis, avenue Jean-Jaures, 94851 Ivry-sur-Seine Cedex, France
TEL: (+33) 1 4987 0300, FAX: (+33) 1 4987 0324

<GERMANY>

NAME: Mega Audio GmbH
ADD: Stromberger Str. 32, D-55411 Bingen, Germany
TEL: (+49) 6721-94330, FAX: (+49) 6721-32046

<GREECE>

NAME: Bon Studio S. A.
ADD: 6 Zaimi Street, Exarchia, 106.83 Athens, Greece
TEL: (+30) 210-3809-605, 606, 607, 608
FAX: (+30) 210-3845-755, 210-3827-868

<ICELAND>

NAME: I. D. elrf. electronic Ltd.
ADD: ARMULA 38 108 REYKJAVIK, ICELAND
TEL: (+354) 588 5010, FAX: (+354) 588 5011

<ITALY>

NAME: Proel S. p. A.
ADD: Zona Via Alla Ruenia, 37/43 64027 - Sant'Omero (Teramo), Italy
TEL: (+39) 0861-81241, FAX: (+39) 0861-887862

<THE NETHERLANDS>

NAME: IEMKE ROOS AUDIO B. V.
ADD: Kuiperbergweg 20, 1101 AG Amsterdam, The Netherlands
TEL: (+31) 20-697-2121, FAX: (+31) 20-697-4201

<NORWAY>

NAME: Siv. Ing. Benum AS
ADD: P. O. Box 145, Vinderen, 0319 Oslo, Norway
TEL: (+47) 2213 9900, FAX: (+47) 2214 8259

<SPAIN>

NAME: Letusa S. A.
ADD: C/Laguna 10, 28923 Alcorcon, Madrid, Spain
TEL: (+34) 91-4862800, 91-4470898
FAX: (+34) 91-6414597

<SWEDEN>

NAME: Kinovox-Benum A/B
ADD: Solna Strandvag 78 171 54 Solna, Sweden
TEL: (+46) 8 5052 1176, FAX: (+46) 8 5052 1010

<SWITZERLAND>

NAME: Audio Bauer Pro AG
ADD: Bernerstrasse-Nord 182, CH-8064 Zurich, Switzerland
TEL: (+41) 1-4323230, FAX: (+41) 1-4326558

<UK>

NAME: SCV London
ADD: 40 Chigwell Lane, Oakwood Hill Industrial Estate, Loughton, Essex IG10 3NY U. K.
TEL: (+44) 20-8418-0778, FAX: (+44) 20-8418-0624

FOR THE US CUSTOMERS ONLY

FOSTEX AMERICA LIMITED WARRANTY

The following statement defines specific legal rights. You may also have additional rights depending on the state in which the Fostex product was purchased.

WARRANTY PROTECTION

All Fostex parts are warranted for one (1) year from the date of original purchase, except for recording media, such as hard disc drives and compact flash cards, heads, lamps and fuses, which are warranted, for one hundred-eighty (180) days. Fostex America will repair and / or replace parts during the term of this warranty. Labor costs are also covered by Fostex America for one (1) year from the date of original purchase. Except as specified below, this warranty covers all defects in material and workmanship in this product.

The following are not covered by this warranty:

1. Batteries.
2. Damage to any product that has been altered.
3. Damage to any product on which the original serial number has been defaced, modified or removed.
4. Damage to or deterioration of the external cabinet.
5. Damage occurring during shipment of the product. (**NOTE:** Shipping claims must be presented to the carrier.)
6. Damage resulting from accident, misuse, abuse or neglect.
7. Damage resulting from failure to perform routine maintenance and / or calibration procedures.
8. Damage resulting from failure to follow instruction in the owner's manual.
9. Damage resulting from repair or attempted repair or by someone other than a Fostex America Service technician or a technician at an authorized Fostex America service station.
10. Damage resulting from causes other than product defects, including lack of technical skill, competence or experience on the part of the user.
11. External appearance items such as cosmetic parts, knobs, liquid crystal displays, buttons, etc.
12. Replacements or repairs necessitated by loss or damages resulting from any cause beyond the control of Fostex America.
13. Damage resulting from misuse or abuse on rental units.

**NOTE: FOSTEX AMERICA IS NOT RESPONSIBLE FOR DATA LOST OR DAMAGED DURING OPERATION OF THIS PRODUCT.
CALIBRATION AND MAINTENANCE PROCEDURES ARE NOT COVERED BY THIS WARRANTY.**

Fostex America reserves the right to inspect all products submitted pursuant to this warranty. If such an inspection shows reasonable cause to believe that any of the above exclusions to the above warranty are applicable, then Fostex America or the authorized service station will charge prevailing service rates and parts, costs for any repairs.

FOSTEX AMERICA LIMITED WARRANTY

To claim all warranty service, first access www.fostex.com to receive service authorization (RMA number). Then present the authorization together with the bill of sale, which shows the date of original purchase to Fostex America. This warranty is not transferable.

SHIPPING

If this product needs service, you must take it, or package it carefully, using ample packaging materials to prevent damage during shipment and mail it to the distributor from whom you have purchased this product, postage pre-paid and insured.

NOTE: Fostex America will not assume responsibility for damages or losses occurred in transit, but will reasonably assist the sender in processing any claims whenever possible (such as submitting statements to the carriers when applicable).

Any collect or C.O.D. shipments will be refused. In order to obtain warranty repairs, you must include the following:

1. Date proof of original purchase (copy of bill of sale or charge slip).
2. A note describing the problem with sufficient particularity to allow Fostex America to inspect or adjust the problem.
3. All accessory items appurtenant to that problem.

LIMITATIONS OF IMPLIED WARRANTIES AND EXCLUSIONS OF CERTAIN DAMAGES

Unless considered unenforceable or unlawful under applicable law:

- A. All implied warranties - including warranties of merchantability and fitness for a particular purpose - are limited in duration to term of this warranty and to the express coverage of this warranty;
- B. Fostex America's liability for any defect product is expressly limited to repair or replacement of the product, at the sole discretion and / or option of Fostex America. Fostex America shall not under any circumstances be liable for:
 1. Damaged based on inconvenience, loss of use of the product, loss of time, interrupted operation or commercial loss, OR;
 2. Any damages, whether incidental, consequential or otherwise, except damages which may not be excluded by under applicable law.
- C. Fostex America makes no other warranties, express or implied, above and / or beyond the representations made herein.

WARRANTY APPLIES ONLY TO THOSE PRODUCTS SOLD AND DISTRIBUTED BY FOSTEX AMERICA

Service Department

FOSTEX AMERICA

9 Mars Court Boonton, NJ 07005

TEL: 973-394-0015 FAX: 973-394-0800

Email: support@fostexusa.com

Web: www.fostex.com

Fostex

FOSTEX CO.

3-2-35 Musashino, Akishima-shi, Tokyo Japan 196-0021