

Powered Near Field Studio Monitor

Model **NF-01A****Introductions**



The NF-01A is a near field studio monitor boasting an analysis ability and check function of the source sound, and sound reproduction capability, refined to an optimal extent, and with built-in amplifiers which allow for a rendition of rich and full sound.

Drivers housed in the enclosure include a 13 cm woofer characterized by its newly developed HP diaphragm, UDR tangential edge and push-pull damper, and a soft dome tweeter with another new development of a UFLC diaphragm.

Featured with both the woofer and tweeter is a high rigidity cast aluminum frame, and HP sound reflectors internal to the enclosure.

A bi-amplifier system is employed to drive the woofer and tweeter with amplifiers delivering up to 50W each of low and high frequency ranges. The use of a filter function provided will allow delicate corrections of reproduced sound. Mixer output is best accepted by the use of either a balanced or unbalanced configuration whichever is the most appropriate for the mixer to be connected.

Fostex®

| | | |
|--|---|---|
|  | CAUTION RISK OF ELECTRIC SHOCK DO NOT OPEN |  |
| <p>CAUTION: TO REDUCE THE RISK OF ELECTRIC SHOCK, DO NOT REMOVE COVER (OR BACK). NO USER - SERVICEABLE PARTS INSIDE. REFER SERVICING TO QUALIFIED SERVICE PERSONNEL.</p> | | |

"WARNING"

"TO REDUCE THE RISK OF FIRE OR ELECTRIC SHOCK, DO NOT EXPOSE THIS APPLIANCE TO RAIN OR MOISTURE."

SAFETY INSTRUCTIONS

1. Read Instructions - All the safety and operating instructions should be read before the appliance is operated.
2. Retain Instructions - The safety and operating instructions should be retained for future reference.
3. Heed Warnings - All warnings on the appliance and in the operating instructions should be adhered to.
4. Follow Instructions - All operating and use instructions should be followed.
5. Water and Moisture - The appliance should not be used near water - for example, near a bathtub, washbowl, kitchen sink, laundry tub, in a wet basement, or near a swimming pool, and the like.
6. Carts and Stands - The appliance should be used only with a cart or stand that is recommended by the manufacturer.



An appliance and cart combination should be moved with care. Quick stops, excessive force, and uneven surfaces may cause the appliance and cart combination to overturn.

7. Wall or Ceiling Mounting - The appliance should be mounted to a wall or ceiling only as recommended by the manufacturer.
8. Ventilation - The appliance should be situated so that its location or position does not interfere with its proper ventilation. For example, the appliance should not be situated on a bed, sofa, rug, or similar surface that may block the ventilation openings; or, placed in a built-in installation, such as a bookcase or cabinet that may impede the flow of air through the ventilation openings.

| |
|---|
| <p>CAUTION: TO PREVENT ELECTRIC SHOCK, MATCH WIDE BLADE OF PLUG TO WIDE SLOT, FULLY INSERT.</p> <p>ATTENTION: POUR ÉVITER LES CHOCS ÉLECTRIQUES, INTRODUIRE LA LAME LA PLUS LARGE DE LA FICHE DANS LA BORNE CORRESPONDANTE DE LA PRISE ET POUSSER JUSQU' AU FOND.</p> |
|---|



The lightning flash with arrowhead symbol, within an equilateral triangle, is intended to alert the user to the presence of uninsulated "dangerous voltage" within the product's enclosure that may be of sufficient magnitude to constitute a risk of electric shock to persons.



The exclamation point within an equilateral triangle is intended to alert the user to the presence of important operating and maintenance (servicing) instructions in the literature accompanying the appliance.

9. Heat - The appliance should be situated away from heat sources such as radiators, heat registers, stoves, or other appliances (including amplifiers) that produce heat.
10. Power Sources - The appliance should be connected to a power supply only of the type described in the operating instructions or as marked on the appliance.
11. Grounding or Polarization - The precautions that should be taken so that the grounding or polarization means of an appliance is not defeated.
12. Power Cord Protection - Power supply cords should be routed so that they are not likely to be walked on or pinched by items placed upon or against them, paying particular attention to cords at plugs, convenience receptacles, and the point where they exit from the appliance.
13. Cleaning - The appliance should be cleaned only as recommended by the manufacturer.
14. Nonuse Periods - The power cord of the appliance should be unplugged from the outlet when left unused for a long period of time.
15. Object and Liquid Entry - Care should be taken so that objects do not fall and liquids are not spilled into the enclosure through openings.
16. Damage Requiring Service - The appliance should be serviced by qualified service personnel when:
 - A. The power supply cord or the plug has been damaged; or
 - B. Objects have fallen, or liquid has been spilled into the appliance; or
 - C. The appliance has been exposed to rain; or
 - D. The appliance does not appear to operate normally or exhibits a marked change in performance; or
 - E. The appliance has been dropped, or the enclosure damaged.
17. Servicing - The user should not attempt to service the appliance beyond that described in the operating instructions. All other servicing should be referred to qualified service personnel.

Precautions

- In the event of smoke or odors, immediately turn off the power switch and remove the AC plug from the outlet. Continued use under such conditions will result in fire and/or electrical shock.
After extinction of such conditions, refer the problem to a dealer or our service station located nearest to you. In no events must an attempt to correct the problem by unauthorized personnel take place. Noncompliance with this notice may pose an extreme danger.
- In the event of entry of water or an object into the appliance, immediately turn off the power switch and remove the AC plug from the AC outlet.
A dealer or our service station located nearest to you must be contacted for reinstatement of the original conditions. Continued use without it will result in fire and/or electrical shock.
- In the event of electrical discontinuity and/or damage including conductor exposure occurs to the power cord, contact a dealer or our service station located nearest to you for service. Continued use without it will result in fire and/or electrical shock.
- In the event of a fall of the appliance or damage to appliance cover, immediately remove the AC plug from the AC outlet and contact a dealer or our service station located nearest to you for service.
Continued use without it will result in fire and/or electrical shock.
- Placement of the appliance where contact with water is likely must be avoided. Otherwise, fire and/or electrical shock will result. This precaution is particularly important when the appliance is used outdoors (on rainy or snowy days, on the beach or other such places).
- No vases or cups containing water, and/or small metal pieces must be placed on the appliance.
Spilling of water or dropping of metal pieces into the appliance will result in fire and/or electrical shock.
- Under no circumstances, must an attempt be made to disassemble, repair and/or alter the appliance.
Neither must the appliance cover be removed.
Otherwise, fire and/or electrical shock will result.
- No contact with the AC plug must be made after lightning has started. Otherwise, electrical shock will result.
- No heavy objects must be placed on the AC cord nor the cord be routed under the appliance.
Damage to the cord will occur resulting in fire and/or electrical shock.
- The AC cord must not be damaged, modified, twisted, pulled and/or heated. Otherwise, the cord will be damaged resulting in fire and/or electrical shock.
- No power voltage different from that labeled on the appliance or specified in this owner's manual must be applied. The power plug must be inserted to the end of an outlet. Otherwise, fire and/or electrical shock will result.
- Avoid placement of the appliance in smoky or steamy places including unusually humid or dusty places.
Otherwise, fire and/or electrical shock may result.
- The AC cord must not be routed near heat emitting appliances. Otherwise, the cord jacket may melt resulting in fire and/or electrical shock.
- Avoid mounting or setting the appliance on unstable surfaces, including wobbly or slanting planes.
Contact with the falling appliance may cause injury.
- Do not leave the appliance in places where the temperature will rise excessively, including an automobile with windows closed or an area exposed to direct sunlight. Otherwise, fire may result.
- This appliance is built with precision components.
Moving of the appliance must be accomplished by at least two persons with care.
- Relocation of this appliance must occur only after the power has been turned off and the AC plug and all other connecting cords have been disconnected.
Otherwise, cords may be damaged resulting in fire and/or electrical shock.
- Connection of other audio equipment to this appliance must proceed only after power to this appliance and equipment to be connected has been shut off and in strict compliance with the wiring instructions given in the manual provided with such equipment. Use of the designated cords is also a prerequisite.
- The loudness control must be set to the minimum before turning this appliance on.
Otherwise, unexpectedly loud sound may be produced resulting in impairment of hearing acuity.
- The power cord must be disconnected when not using of this appliance for an extended period of time (a month or longer). Otherwise, fire and/or electrical shock may result.
- Wet hands must not touch the AC plug. Otherwise, electrical shock may result.
- No cloth, blanket or the like must be placed over this appliance while its power is on. Trapped heat may result in fire.
- Maintenance of this appliance must occur only after the AC plug has been removed. Otherwise, electrical shock may result.
- Use of portable phones near the appliance is not recommended. Otherwise, noise may develop in this appliance.
- Use of this appliance near radio or TV sets may result in the development of noise. If this is the case, keep them apart.

Main features of NF-01A

- An HP diaphragm of a new type is used in the 13 cm woofer. Sound quality to low distortion and high transition, which no other diaphragms can offer, has become a reality.
- Anti - resonance is eliminated by the use of a UDR tangential edge and push-pull damper in the woofer. Also, substantial improvement is made in linearity, and thus, accurate response to the subtlest sound signals is realized.
- The tweeter employing a UFLC diaphragm (of soft dome type), being most compliant to and reproducible of even the subtlest signals, are of a wide range design up to 40kHz.
- A highly rigid cast aluminum frame is used for both woofer and tweeter. This allows successful elimination of sound colorization caused by undesired natural vibration.
- Ultra lossless design offers a natural crossover between the woofer and tweeter. A -6 dB/oct crossover network is used for the woofer, while a -12 dB/oct network is used for the tweeter.
- The use of HP sound reflectors provides an ideal internal sound processing means for elimination of natural vibration developing within the speaker enclosures.
- Power amplifiers capable of delivering 50W/50W output are provided for the bi-amplifier driving system for the woofer and tweeter.
- The low frequency filter switch and tweeter level control are provided, allowing frequency response compensation.
- The amplifier system is capable of accepting balanced (XLR) or unbalanced (phone) input.
- By employing an HP diaphragm and dome tweeter, a wide listening area that no other monitor system can match is obtained.

Names and functions

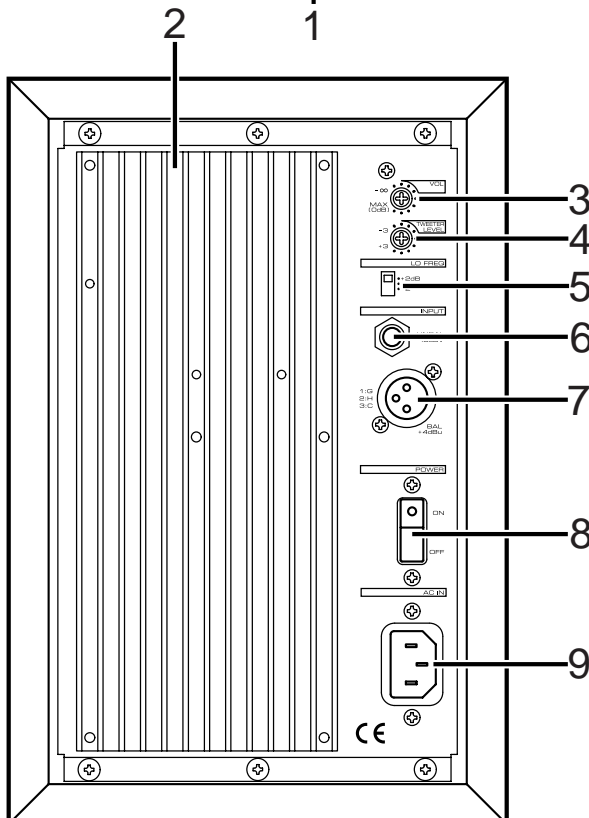
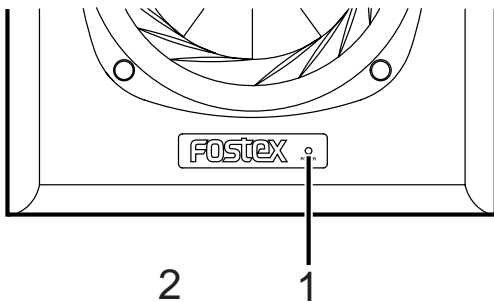

1. Power LED

Lights when power is turned on.

2. Heat sink

<CAUTION>

Avoid contact with the heat sink. Extended time of use will result in a rise of temperature.

3. Loudness control

Adjusts output power. Please refer to the descriptions given on the next page for optimal use.

4. Tweeter level control

Adjusts tweeter level within a +/- 3dB range. Please refer to the description given on the next page for optimal use.

5. Low-frequency filter selector

Adjusts low frequency characteristics (around 55Hz range) within a +/- 2dB range. For detail, please refer to the next page.

6. Unbalanced input terminal (Phone jack)

Accepts -10dBV unbalanced input.

7. Balanced input terminal (XLR-3-31 type)

Accepts +4dBu balanced input (hot pin is #2). Simultaneous input from this terminal and the unbalanced terminal is not possible. Connection to the unbalanced terminal will defeat the balanced terminal function.

8. Power switch

Turns power on. make very sure the volume controls of connected equipment are set to the null level.

9. AC IN connector

Accepts the AC cord provided.

Block diagram

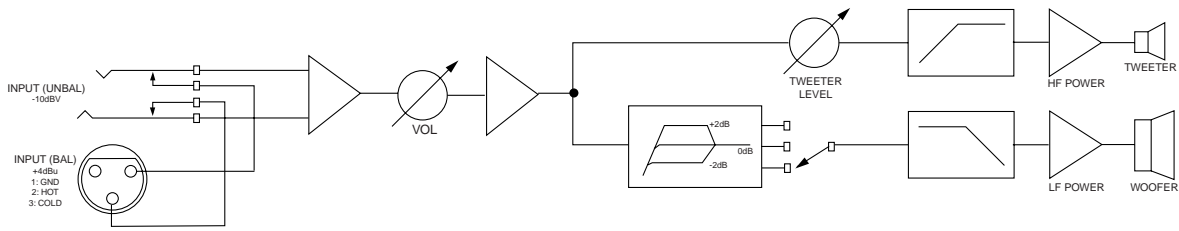

Control positions



- **Power output adjustment**
Turning clockwise using a Philips screw driver increases volume.

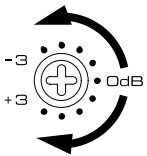

- **Tweeter level adjustment**
An adjustment of a range of +/- 3dB is possible. Turning counterclockwise from the center position (0dB) decreases the tweeter output level, and turning clockwise increases the tweeter level. This control is factory-set at the "0dB" position.

- **Correction to low frequency (55Hz) characteristics**

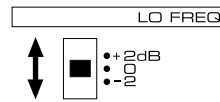

This LO FREQ switch permits correction of the low frequency (55Hz) response by +/- 2dB.

This control is factory-set the "0" position. By setting the switch at the "+2dB" position, the 55Hz response will be enhanced. Setting to the "-2dB", the response will be attenuated by 2dB.

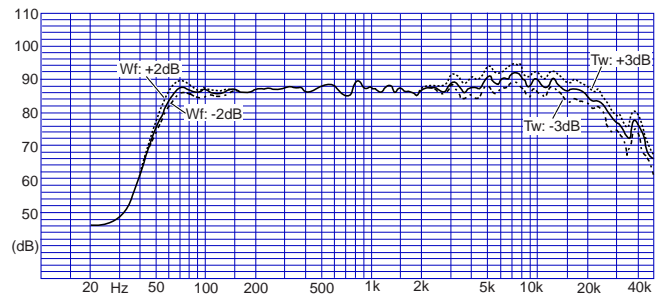

Enclosure positioning

To optimally enjoy NF-01A's accurately time-aligned performance, each enclosure must be positioned so that the 2 drivers will be aligned on a vertical line. The human ear's sensitivity in the right-left direction makes horizontal positioning of enclosures undesirable.

Vertical positioning is also recommendable so that heat generated by the amplifiers can be more effectively dissipated.

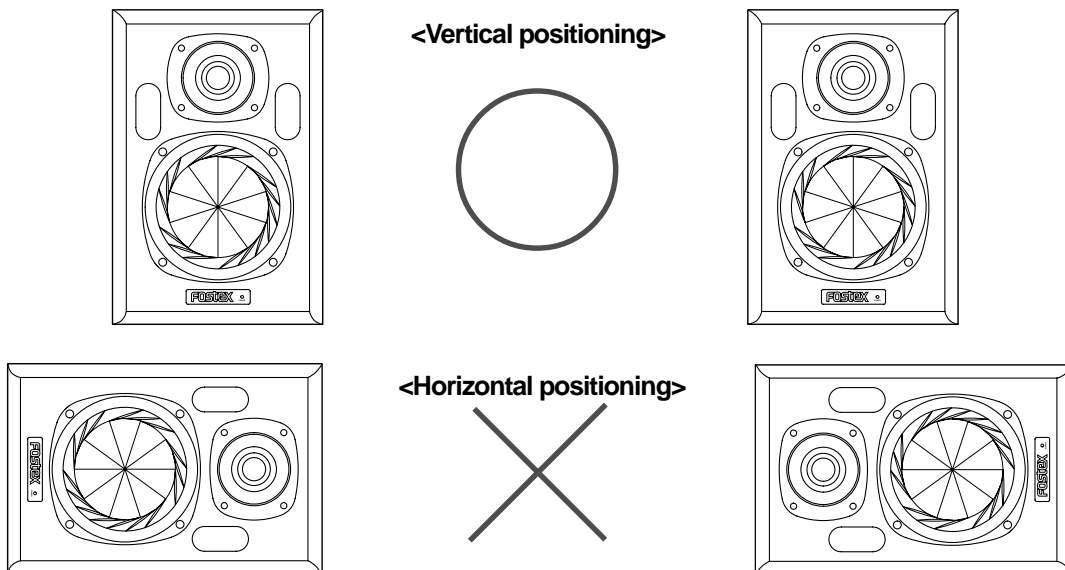

• Optimal listening points and setting

Setting of the system is ideal when the mid-points of the woofer and tweeter meet the listener’s ear level to allow full enjoyment of the NF-01A’s ability.

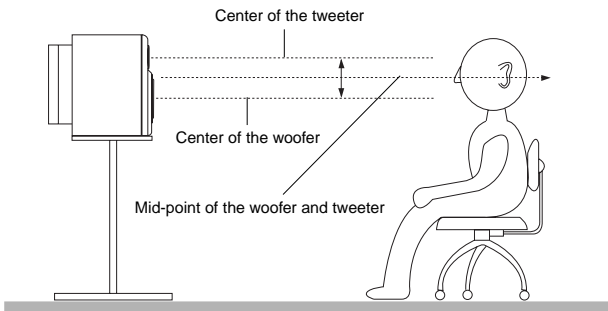

Then, mutually orient them 15 to 30 degrees inward to form a triangle as shown in Figure, with the open vertex of the triangle falling at the planned listening position. The listening position thus determined represents the point where the design intent can be enjoyed to the fullest extent.

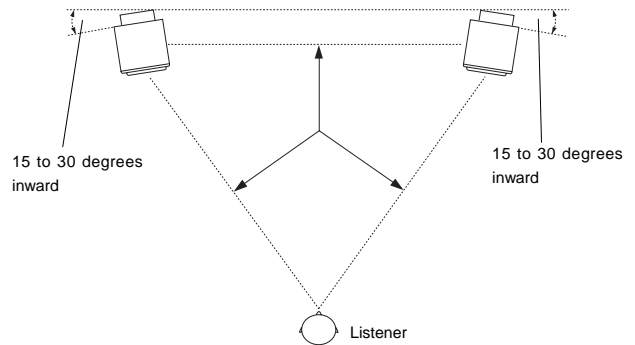

Speaker units

• HP diaphragm

“HP”, an abbreviation of a hyperbolic paraboloid normally called an “HP” shell or “hyper shell”, is a 3-dimensional curved surface structure. This HP structure is characterized primarily by the fact that movement of a straight line connecting 2 line segments, which do not share a single plane, forms a hyperboloid and paraboloid.

HP diaphragm’s configuration is determined by locating inflection points at the top and bottom to form vertical symmetry, so as to disperse stress with pentagonal divisions which are asymmetrical to the center of the diaphragm, as shown on Figure-1, as the basic option, and the height of curved surfaces is selected so that optimal frequency dispersion as dictated by FEM modal analysis results can be realized. The base diaphragm materials are **NBPK** and banana fibers, with carbon fibers of a super high elasticity modulus, **PBO** super-fiber and pearl mica used as reinforcement materials, Cellgaia pulp as super damping fibers and bio-cellulose used as the matrices material.

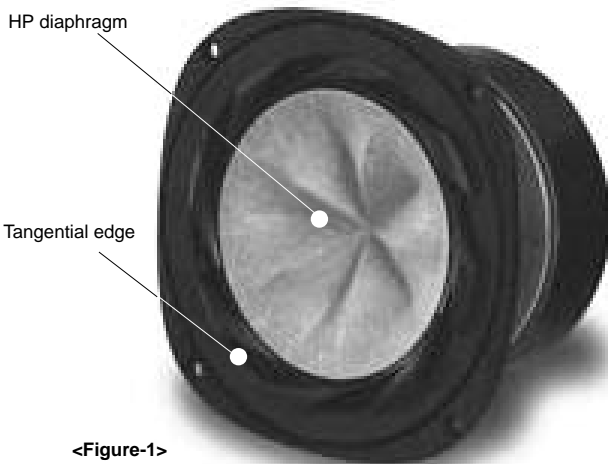

<Figure-1>

• UDR tangential edge

A new era has been opened by the **UDR** (Up/Down Roll) tangential edge structure which is created by joining up-roll and down-roll at their tangential surfaces.

It is configured, through model analyses, to function optimally as diaphragm edges. Use of this edge is with the woofer which plays a key part in the overall speaker system performance.

• UFLC diaphragm

A **UFLC** diaphragm, made of polyurethane plastics which is urethane film laminated over cloth, is used in the tweeter. The use of a **UFLC** diaphragm allows the highest fidelity sound reproduction which extends naturally to extremely high frequencies, which had not been possible with conventional soft dome technology.

• HP sound reflector

HP sound reflectors represent sound reflectors of the HP system arranged inside the enclosure, as depicted in Figure 2. NF-01A has this type of reflectors and micron wool arranged optimally in enclosures to diffusely reflect the sound present in an enclosure, which creates conditions where no standing waves may develop, and finally, for natural attenuation.

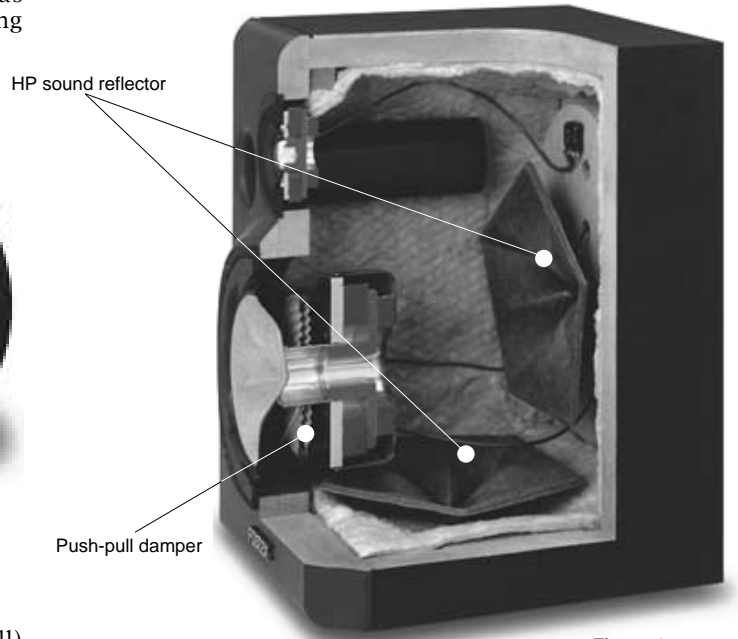

<Figure-2>

* Figures 1 and 2 above show the photographs of the Model NF-1, which employs the same materials and construction as the Model NF-01A. Therefore, note that the shapes of the speaker units and sound reflector shown above are not exactly the same as those for the NF-01A.

Declaration of EC Directive

This equipment is compatible with the EMC Directive (89/336/EEC) - Directive on approximation of member nation's ordinance concerning the electromagnetic compatibility and with the Low Voltage Directive (73/23/EEC) - Directive on approximation of member nation's ordinance concerning electric equipment designed to be used within the specified voltage range.

The Affect of Immunity on This Equipment

The affect of the European Specification EN50082-1 (coexistence of electromagnetic waves - common immunity specification) on this equipment are as shown below.

In the electrical fast transient/burst requirements, surge, conducted disturbances by radio-frequency fields, power frequency magnetic field, radiate electromagnetic field requirements and static electricity discharging environment, this could be affected by generation of noise in some cases.

FOSTEX DISTRIBUTORS LIST IN EUROPE

* Including non-EU countries (as of January, 2002)

<AUSTRIA>

NAME: ATEC Audio-u. Videogeraete VertriebsgesmbH.
ADD: Im Winkel 5, A-2325 Velm, Austria
TEL: (+43) 2234-74004, FAX: (+43) 2234-74074

<BELGIUM>

NAME: EML Sound Industries NV
ADD: Bijvennestraat 1A, B3500 Hasselt, Belgium
TEL: (+32) 11-232355, FAX: (+32) 11-232172

<DENMARK>

NAME: SC Sound ApS
ADD: Malervej 2, DK-2630 Taastrup, Denmark
TEL: (+45) 4399-8877, FAX: (+45) 4399-8077

<FINLAND>

NAME: Noretron Oy Audio
ADD: P. O. Box 22, FIN-02631 Espoo, Finland
TEL: (+358) 9-5259330, FAX: (+358) 9-52593352

<FRANCE>

NAME: Guillard Musiques
ADD: ZAC de Folliouses, B. P. 609, Les Echets, 01706 Miribel, France
TEL: (+33) 472 26 27 00, FAX: (+33) 472 26 27 01

<GERMANY>

NAME: Studiosound & Music GmbH
ADD: Industriestrasse 20, D-35041 Marburg, F. R. Germany
TEL: (+49) 6421-92510, FAX: (+49) 6421-925119

<GREECE>

NAME: Bon Studio S. A.
ADD: 6 Zaimi Street, Exarchia, 106.83 Athens, Greece
TEL: (+30) 1-3809605-8, 3302059, FAX: (+30) 1-3845755

<ICELAND>

NAME: I. D. elrf. electronic Ltd.
ADD: ARMULA 38 108 REYKJAVIK, ICELAND
TEL: (+354) 588 5010, FAX: (+354) 588 5011

<ITALY>

NAME: Proel S. p. A.
ADD: Zona Artigianale 64047 - Sant'Omero (Teramo), Italy
TEL: (+39) 0861-81241, FAX: (+39) 0861-887862

<THE NETHERLANDS>

NAME: IEMKE ROOS AUDIO B. V.
ADD: Kuiperbergweg 20, 1101 AG Amsterdam, The Netherlands
TEL: (+31) 20-697-2121, FAX: (+31) 20-697-4201

<NORWAY>

NAME: Siv. Ing. Benum A/S
ADD: P. O. Box 145 Vinderen, 0319 Oslo 3, Norway
TEL: (+47) 22-139900, FAX: (+47) 22-148259

<PORTUGAL>

NAME: Caius - Tecnologias Audio e Musica, Lda.
ADD: Rua de Santa Catarina, 131 4000 Porto, Portugal
TEL: (+351) 2-2086009/2001394,
FAX: (+351) 2-2054760/2087488

<SPAIN>

NAME: Multitracker, S. A.
ADD: C/Garcilaso No.9, Madrid 28010, Spain
TEL: (+34) 91-4470700, 91-4470898, FAX: (+34) 91-5930716

<SWEDEN>

NAME: TTS Scandinavia AB
ADD: Kavallerivagen 24, 172 48 Sundbyberg, Sweden
TEL: (+46) 8-59798000, FAX: (+46) 8-59798001

<SWITZERLAND>

NAME: Audio Bauer Pro AG
ADD: Bernerstrasse-Nord 182, CH-8064 Zurich, Switzerland
TEL: (+41) 1-4323230, FAX: (+41) 1-4326558

<UK>

NAME: SCV London
ADD: 40 Chigwell Lane, Oakwood Hill Industrial Estate, Loughton, Essex IG10 3NY U. K.
TEL: (+44) 020-8418-0778, FAX: (+44) 020-8418-0624