

8588107000
(485793)

Model LM16



LIVE MIXER

Owner's manual



<Note>: The LM16 will be upgraded to a new version for feature enhancement or improvement. Check the information about the latest software version from the Fostex website (<http://www.fostexinternational.com/>), Fostex service station or your local Fostex dealer. You can upgrade the software yourself. See page 36 for details about how to upgrade the software.

Fostex[®]

 <div style="display: inline-block; text-align: center;"> <p>CAUTION RISK OF ELECTRIC SHOCK DO NOT OPEN</p> </div> 
<p>CAUTION: TO REDUCE THE RISK OF ELECTRIC SHOCK, DO NOT REMOVE COVER (OR BACK). NO USER - SERVICEABLE PARTS INSIDE. REFER SERVICING TO QUALIFIED SERVICE PERSONNEL.</p>

"WARNING"

"TO REDUCE THE RISK OF FIRE OR ELECTRIC SHOCK, DO NOT EXPOSE THIS APPLIANCE TO RAIN OR MOISTURE."

SAFETY INSTRUCTIONS

1. Read Instructions - All the safety and operating instructions should be read before the appliance is operated.
2. Retain Instructions - The safety and operating instructions should be retained for future reference.
3. Heed Warnings - All warnings on the appliance and in the operating instructions should be adhered to.
4. Follow Instructions - All operating and use instructions should be followed.
5. Water and Moisture - The appliance should not be used near water - for example, near a bathtub, washbowl, kitchen sink, laundry tub, in a wet basement, or near a swimming pool, and the like.
6. Carts and Stands - The appliance should be used only with a cart or stand that is recommended by the manufacturer.



An appliance and cart combination should be moved with care. Quick stops, excessive force, and uneven surfaces may cause the appliance and cart combination to overturn.

7. Wall or Ceiling Mounting - The appliance should be mounted to a wall or ceiling only as recommended by the manufacturer.
8. Ventilation - The appliance should be situated so that its location or position does not interfere with its proper ventilation. For example, the appliance should not be situated on a bed, sofa, rug, or similar surface that may block the ventilation openings; or, placed in a built-in installation, such as a bookcase or cabinet that may impede the flow of air through the ventilation openings.
9. Heat - The appliance should be situated away from heat sources such as radiators, heat registers, stoves, or other appliances (including amplifiers) that produce heat.
10. Power Sources - The appliance should be connected to a power supply only of the type described in the operating instructions or as marked on the appliance.
11. Grounding or Polarization - The precautions that should be taken so that the grounding or polarization means of an appliance is not defeated.

CAUTION:
TO PREVENT ELECTRIC SHOCK, MATCH WIDE BLADE OF PLUG TO WIDE SLOT, FULLY INSERT.

ATTENTION:
POUR ÉVITER LES CHOCS ÉLECTRIQUES, INTRODUIRE LA LAME LA PLUS LARGE DE LA FICHE DANS LA BORNE CORRESPONDANTE DE LA PRISE ET POUSSER JUSQU' AU FOND.



The lightning flash with arrowhead symbol, within an equilateral triangle, is intended to alert the user to the presence of uninsulated "dangerous voltage" within the product's enclosure that may be of sufficient magnitude to constitute a risk of electric shock to persons.



The exclamation point within an equilateral triangle is intended to alert the user to the presence of important operating and maintenance (servicing) instructions in the literature accompanying the appliance.

12. Power Cord Protection - Power supply cords should be routed so that they are not likely to be walked on or pinched by items placed upon or against them, paying particular attention to cords at plugs, convenience receptacles, and the point where they exit from the appliance.
13. Cleaning - The appliance should be cleaned only as recommended by the manufacturer.
14. Nonuse Periods - The power cord of the appliance should be unplugged from the outlet when left unused for a long period of time.
15. Object and Liquid Entry - Care should be taken so that objects do not fall and liquids are not spilled into the enclosure through openings.
16. Damage Requiring Service - The appliance should be serviced by qualified service personnel when:
 - A. The power supply cord or the plug has been damaged; or
 - B. Objects have fallen, or liquid has been spilled into the appliance; or
 - C. The appliance has been exposed to rain; or
 - D. The appliance does not appear to operate normally or exhibits a marked change in performance; or
 - E. The appliance has been dropped, or the enclosure damaged.
17. Servicing - The user should not attempt to service the appliance beyond that described in the operating instructions. All other servicing should be referred to qualified service personnel.
18. The appliance should be situated away from drops of water or spray of water.
19. Objects containing liquid such as vase must not be put on the appliance.
20. The appliance is not completely isolated from the power supply even if the power switch is at off position.
21. Apparatus shall not be exposed to dripping or splashing and no objects filled with liquids, such as vases, shall be placed on the apparatus.
22. Only use attachments/accessories specified by the manufacturer.
23. An appliance with a protective earth terminal should be connected to a mains outlet with a protective earth connection.
24. An appliance should be placed in a position where an AC plug / inlet can be easily pulled out by hand.
25. Main plug is used as the disconnection device. It shall remain readily operable and should not be obstructed during intended use. To be completely disconnected the apparatus from supply mains, the mains plug of the apparatus shall be disconnected from the mains socket outlet completely.

Important Safety Instructions

- 1) Read these instructions.
- 2) Keep these instructions.
- 3) Heed all warnings.
- 4) Follow all instructions.
- 5) Do not use this apparatus near water.
- 6) Clean only with dry cloth.
- 7) Do not block any ventilation openings. Install in accordance with the manufacturer's instructions.
- 8) Do not install near any heat sources such as radiators, heat registers, stoves, or other apparatus (including amplifiers) that produce heat.
- 9) Do not defeat the safety purpose of the polarized or grounding-type plug. A polarized plug has two blades with one wider than the other. A grounding type plug has two blades and a third grounding prong. The wide blade or the third prong are provided for your safety. If the provided plug does not fit into your outlet, consult an electrician for replacement of the obsolete outlet.
- 10) Protect the power cord from being walked on or pinched particularly at plugs, convenience receptacles, and the point where they exit from the apparatus.
- 11) Only use attachments/accessories specified by the manufacturer.
- 12) Use only with the cart, stand, tripod, bracket, or table specified by the manufacturer, or sold with the apparatus. When a cart is used, use caution when moving the cart/apparatus combination to avoid injury from tip-over.



- 13) Unplug this apparatus during lightning storms or when unused for long periods of time.
- 14) Refer all servicing to qualified service personnel. Servicing is required when the apparatus has been damaged in any way, such as power-supply cord or plug is damaged, liquid has been spilled or objects have fallen into the apparatus, the apparatus has been exposed to rain or moisture, does not operate normally, or has been dropped.
- 15) Excessive sound pressure from earphones and headphones can cause hearing loss.

Table of contents

Safety instructions2

Introduction7

About power supply7

Precautions on installation7

About version upgrade7

Condensation8

Cleaning the exterior8

About damage8

About CAT-5 cable8

Overview9

Main features10

Before using the unit11

Unpacking the carton11

Usage examples of LM1612

<Usage example 1> Integrating the main unit and control unit12

<Usage example 2> Mounting the main unit and control unit on the rack12

<Usage example 3> Setting the main unit and control unit separately12

Integrating the control unit and main unit13

Preparation of power supply15

Connecting the power cord15

Turning on the power15

Procedures of turning on the power after connecting peripheral devices15

Procedures of turning off the power after connecting peripheral devices15

Connection to external devices16

Connection example (live stage)16

Connection example (home recording)17

Balanced and unbalanced inputs/outputs18

Names and functions19

Control unit (input channel 1 through 16)20

Control unit (master channel)22

Control unit (rear panel)25

Main unit (rear panel)25

Mixer basics27

Signal flow of the mixer27

Connecting sources28

Connecting sources to the input connectors28

Phantom power supply setting28

Selecting channel source28

Adjusting the input level28

Low-cut filter29

Limiter29

Equalizer29

EQ HIGH30

EQ MID30

EQ LO30

Using an external effect processor30

Using AUX 1, 2 and 330

Using Insert31

Using the internal effects processor31
 Applying the internal effects31
 About the effect types32

Monitoring32
 Solo monitor33

Channel grouping33

Using SUB IN34

Block diagram35

Upgrading the software36

 Checking the current software version36

 How to upgrade the version37

Specifications38

 Inputs/Outputs38

 General39

 Physical dimensions39

 MMC Commands List40

 MIDI Implementation Chart41

 Declaration of EC Directive42

 FOSTEX AMERICA LIMITED WARRANTY43

 INDEX45

Introduction

Thank you very much for purchasing the Model LM16.

The LM16 is a live mixer which consists of the control unit which is equipped with a digital mixer and the main unit which is equipped with the I/O connectors.

To ensure the best performance, read this manual thoroughly before using the LM16. Keep this manual handy for future reference.

About power supply

- Be sure to connect the LM16 to the power supply specified in the specifications section of this owner's manual. Do not use an AC outlet of any other voltage.
- Do not connect the LM16 to the same AC outlet to which devices that could generate noise (such as a large motor or dimmer), or the devices that consume a large amount of power (such as an air conditioning system or large electric heater) are connected.
- If you use the LM16 in an area with a different power voltage, first consult your dealer or the nearest Fostex service station. You can use the LM16 with a power frequency of 50Hz or 60Hz.
- It is very dangerous to use a power cord that is frayed or damaged. In such a case, stop using the LM16 immediately and ask your dealer to repair the cord.
- To avoid possible electric shock and damage to the LM16, avoid contact with water or other liquids, or do not handle the power plug while your hands are wet.
- To prevent possible electric shock and damage to the LM16, do not remove the main unit cover or reach the inside of the LM16.
- Do not let water or other liquid, or metal objects such as pins, accidentally enter the inside of the LM16 because this may lead to electric shock or damage. Should water enter the inside of the LM16, remove the power plug from AC outlet, and consult your dealer or the nearest Fostex service station.

- To prevent damage to the LM16, be sure to power on the connected devices first, then turn on the power to the LM16. When you remove or connect the cables to the input/output connectors on the LM16, make sure that the channel and master faders and volume controls are set "∞".

Precautions on installation

- Do not install the unit in the following conditions.
 - * In an extremely hot or cold place
 - * In a moist place
 - * In a vibrated place
 - * In a dusty place
 - * In a strong magnetic field or near a device which generates a magnetic field
 - * In the direct sunshine
 - * In the direct shower or rain
- To integrate the main unit and control unit or mount them to a rack, follow the instruction described in this manual (note that screws for rack mounting are not supplied with the LM16).

About version upgrade

- The software of the LM16 will be upgraded in the future. You can download the latest software from our website and upgrade the LM16 yourself. For details about how to upgrade the LM16 to the latest software version, see page 36.

Condensation

- When temperature and humidity change suddenly (for example, when you move the LM16 from a cold place to a warm place), moisture condensation may occur to the display and panel.
In such a case, leave it with the power turned off for some time until the moisture evaporates.

Cleaning the exterior

- For normal cleaning, use a soft dry cloth. For stubborn dirt, moisten a cloth in diluted detergent, wring it out firmly, and wipe the dirt off.
Then polish with a dry cloth. Never use solvents such as alcohol, thinner or benzene, since these will damage the printing and finish of the exterior.

About damage

- Fostex is not responsible for any “direct damage” or “indirect damage” caused by using the LM16.

About CAT-5 cable

- Use only a CAT-5 STP cable for connection between the main unit and the control unit.

<Note>: Do not connect or disconnect a CAT-5 cable while the LM16 is powered on. When you connect or disconnect a CAT-5 cable, make sure that the LM16 is powered off.

Overview

The Model LM16 consists of the control unit which is equipped with a digital mixer with intuitive analog like operation and the main unit which is equipped with the I/O connectors. You can install the LM16 flexibly by integrating these units, mounting them on a rack or setting them away from each other (up to 50 meter distance using a CAT-5 cable).

The LM16 is an ideal tool for schools, houses of worship, clubs, coffee houses, project studios, mobile recording, rental sound/recording, etc.

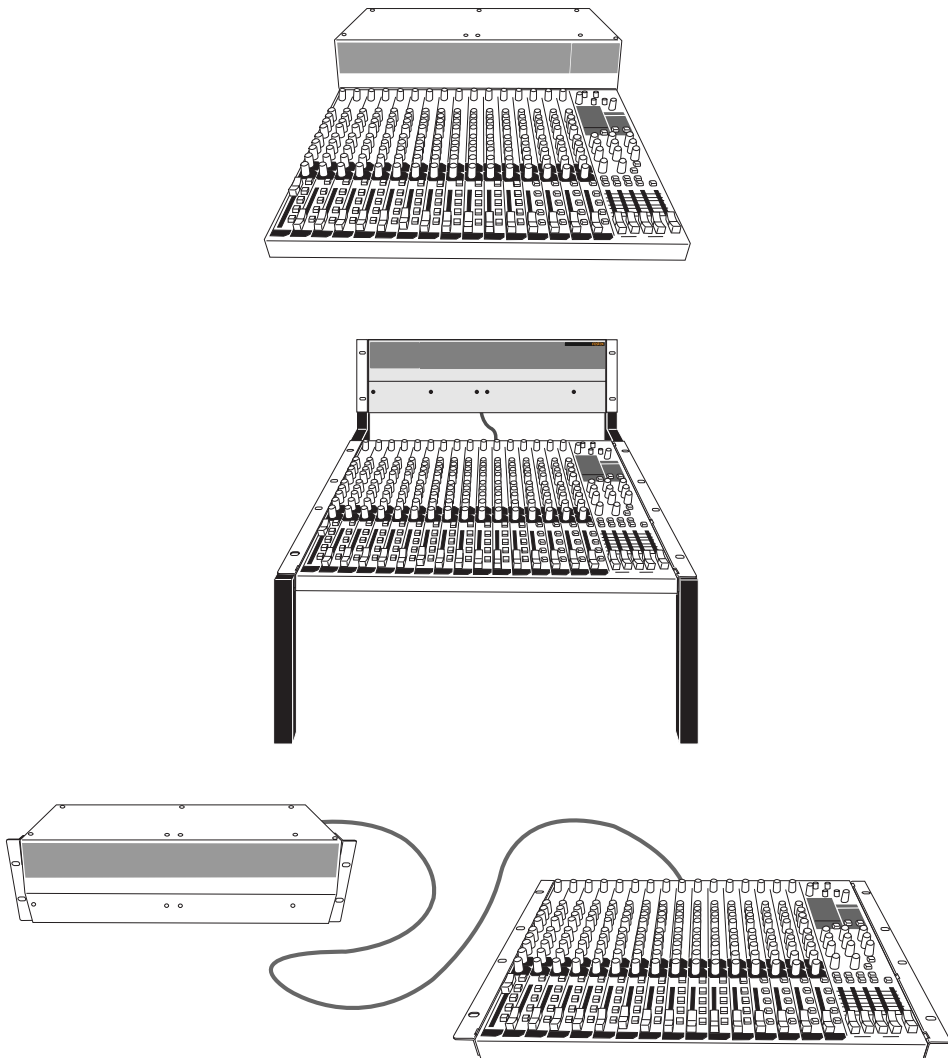

<Note>: The CAT-5 cable supplied with the LM16 is approximately 50 cm length. This cable can be used when installing the LM16 by integrating the control and main units. To mount them on a rack or set them away from each other, prepare an appropriate CAT-5 cable (straight type) which has enough length (up to 50 m).

Main features

- Digitally controlled trim on each input channel, allowing optimum input level adjustment for each mic/line input.
- Fostex originally-developed digital effect unit (reverb/delay) is built in, allowing selection from 12 effect types.
- Provides 16 input faders, four group faders and stereo master fader, allowing analog like operation.
- 3-band (High/Mid/Low) input equalizer on each input channel.
- Insertion point on input channel 1 through 8, allowing connection to an external comp/limiter, etc.
- XLR-phone combo type connector provided on each input channel, allowing mic or line connection. In addition, phantom power can be supplied to each XLR connector, allowing use of a condenser microphone. (You can turn on or off phantom power in eight channel groups.)
- Four group outputs allow connection to an external mixer or multitrack recorder.
- Aux and effect sends allow connection to an external effect unit, a stage monitor system, etc.
- You can easily upgrade the unit software by downloading the file for upgrading the unit from the Fostex website and copying it to a USB memory stick, then connecting it to the [USB (HOST)] port.
- Outputs MMC (MIDI Machine Control) commands (play, stop and record commands) from the [MIDI OUT] port for controlling an external MIDI device.

Before using the unit

Read this chapter carefully before using the unit.

Unpacking the carton

Unpack the carton and inspect the contents for damage or shortages.
The following contents should be found in the carton. If you find any damage or shortages,
contact your Fostex dealer.

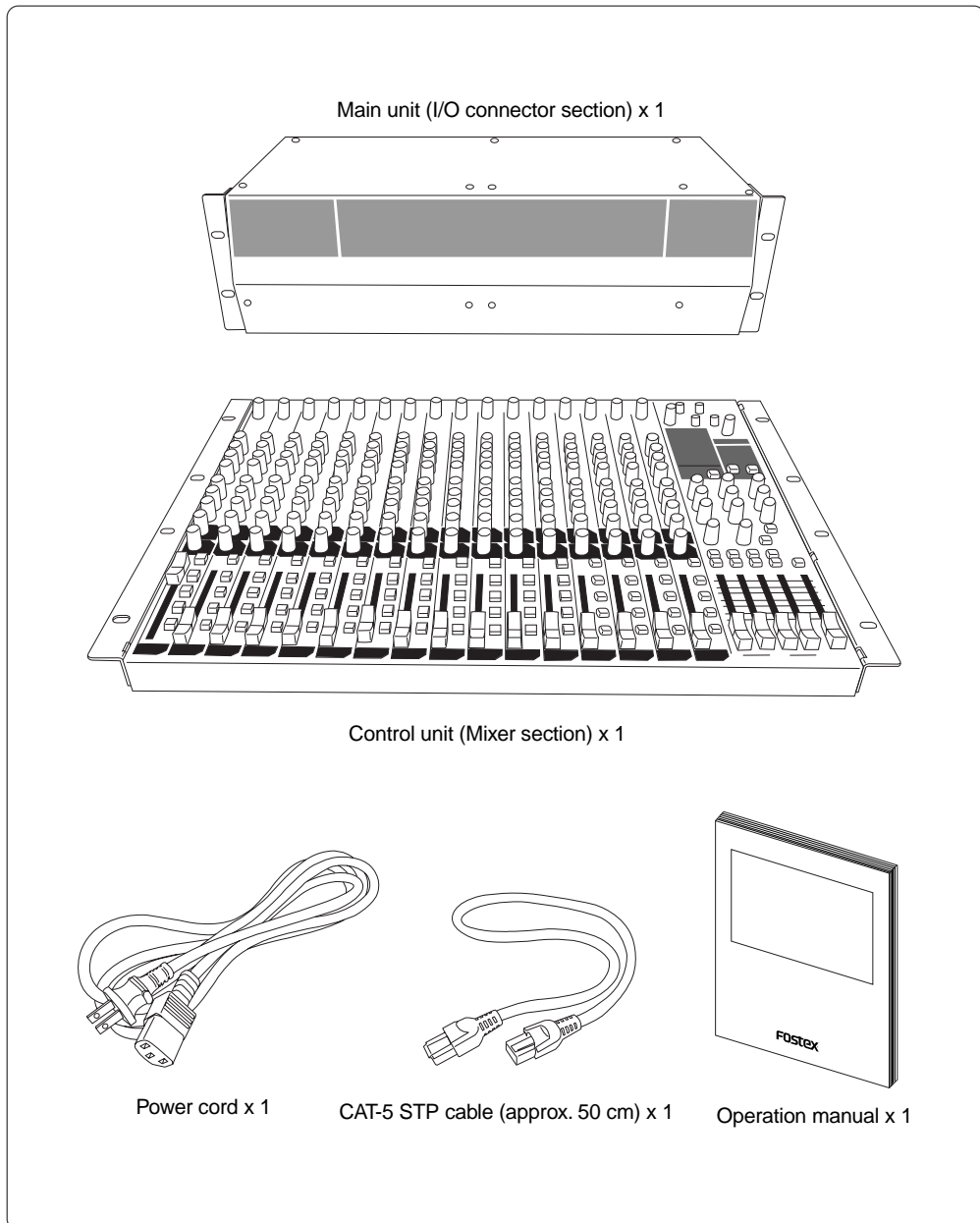

Usage examples of LM16

The control unit and main unit of the LM16 are separated. You can set these units flexibly.

<Usage example 1>

Integrating the main unit and control unit.

You can integrate the main unit and control unit.

Use the supplied CAT-5 cable (approx. 50 cm length) to connect between the units. See the next page for details about how to integrate the units.

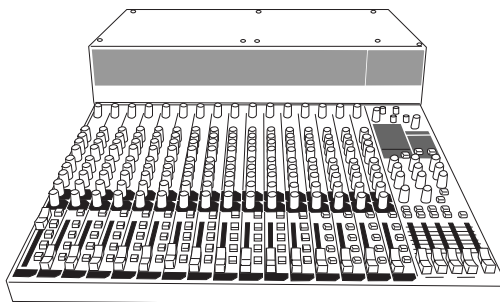

<Usage example 2>

Mounting the main unit and control unit on the rack.

As shown on the right, you can mount each unit to the rack. In this case, use a CAT-5 cable which has enough length for connecting between the units (the cable supplied with the LM16 is approximately 50 cm length).

<Note>: Use only a CAT-5 STP cable (straight type) for connection between the main unit and the control unit.

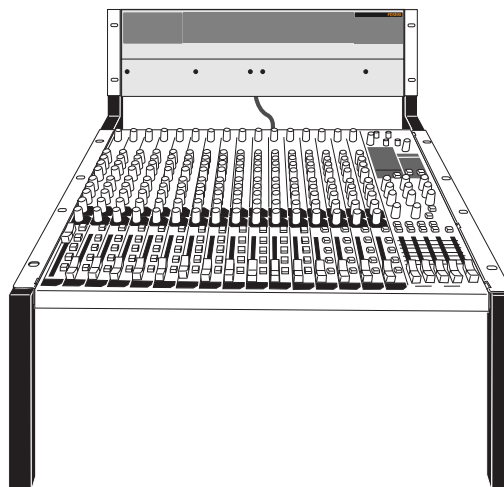

<Usage example 3>

Setting the main unit and control unit separately.

You can set the main unit and control unit over a 50 meter distance. In such a case, use a CAT-5 cable which has enough length for connecting between the units (the cable supplied with the LM16 is approximately 50 cm length).

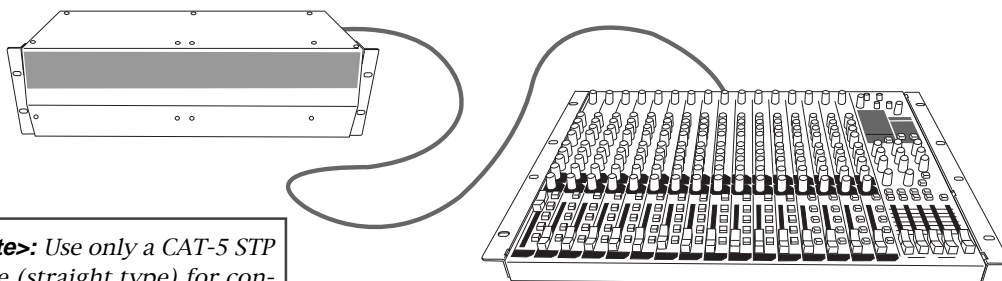

<Note>: Use only a CAT-5 STP cable (straight type) for connection between the main unit and the control unit.

Integrating the control unit and main unit

Follow the procedure below to integrate the control unit and main unit.

<Note>: Work on a flat and stable surface. It is recommended to put the units on a soft cloth (or blanket) to protect the units.

<Necessary items>

- Phillips-head screwdriver (which matches the fixing screws for rack mounting)
- The supplied CAT-5 cable

- (1) **Remove the rack mount adaptors attached to the side panels of each unit.**
The removed rack mount adaptors and fixing screws are used in step (3) below, so be careful not to loose them.

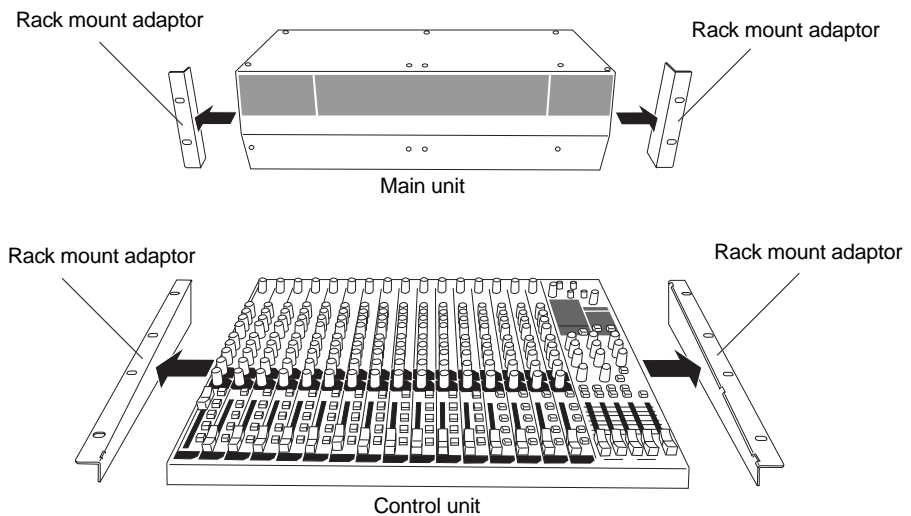

- (2) **Connect the [ETHER] connector of the control unit and the [CONTROLLER] connector of the main unit using the supplied CAT-5 cable.**

The cable should run through the cable guides fixed near the connectors of the both units (see below).

<Note>: Do not connect or disconnect a CAT-5 cable while the LM16 is powered on.
When you connect or disconnect a CAT-5 cable, make sure that the LM16 is powered off.

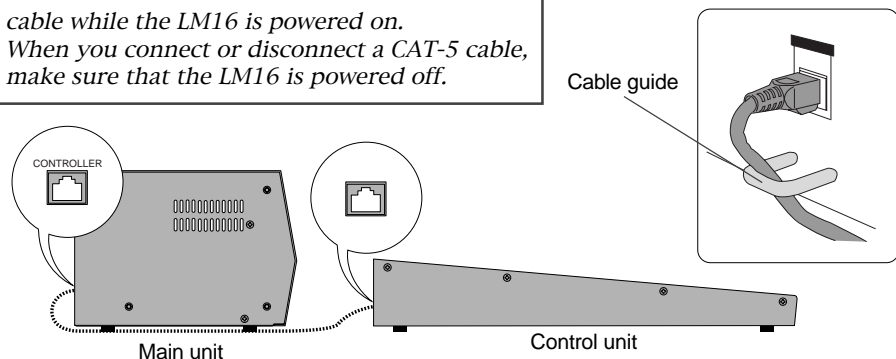

<Note>: Insert the connector of the cable firmly in the correct direction.

(3) Using the rack mount adaptors removed from the control unit, fix the control unit and main unit.

Attach the rack mount adaptors to the both left and right sides in the direction shown below. Use four screws for each side.

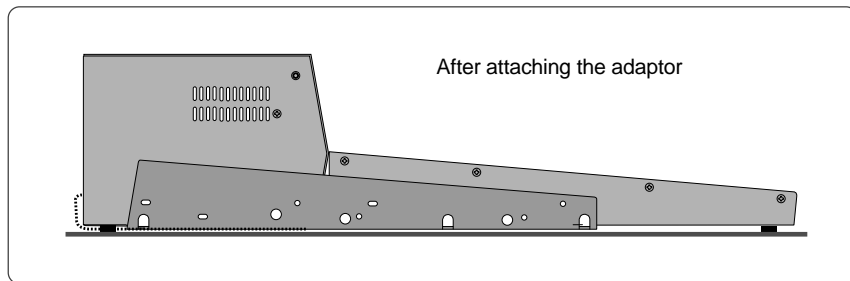
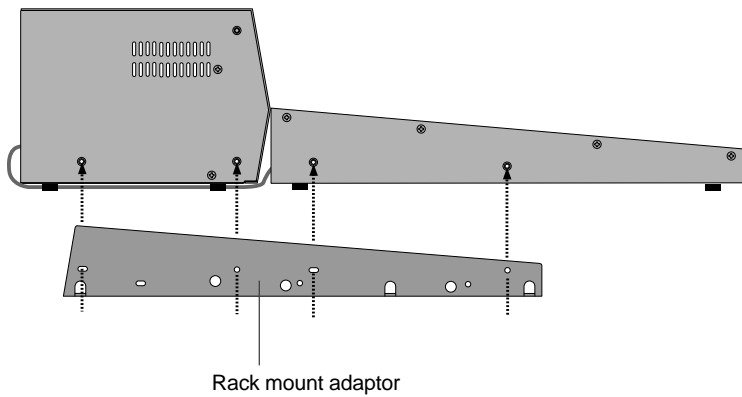

(4) Put the CAT-5 cable into the space between the rubber feet and mounting bracket (indicated by arrows below).

The space between the rubber feet and mounting bracket is narrow, so be careful not to damage the cable when you put it into the space.

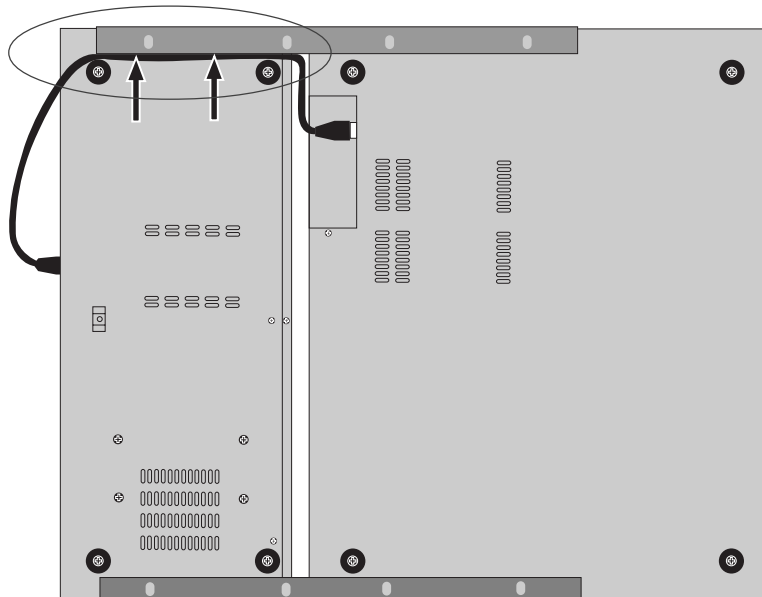

Preparation of power supply

Connecting the power cord

Using the supplied power cord, connect the [AC IN] connector on the rear panel of the main unit and the AC outlet.

<Note>: Use only the supplied power cord.

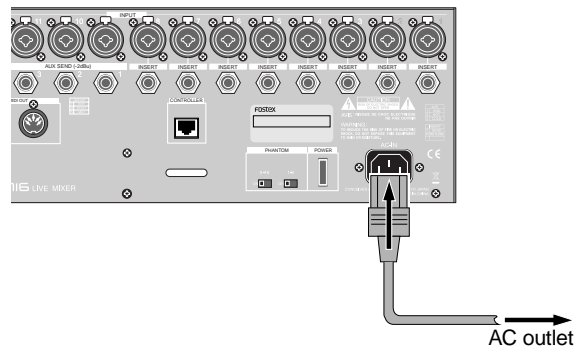

Turning on the power

Press down the [POWER] switch on the rear panel of the main unit to turn on the power.

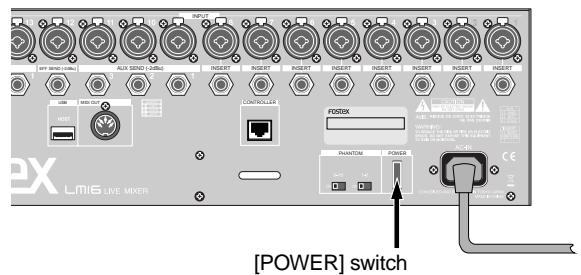

To turn on or off the LM16 and peripheral devices which are connected to the LM16, follow the proper procedures described below.

Procedures of turning on the power after connecting peripheral devices

<Note>: Before turning on or off the LM16 and peripheral devices which are connected to the LM16, make sure that the channel faders and monitor gain control of the LM16, as well as the volume control of an monitor amplifier (or powered monitor speaker), are set to minimum. Otherwise, a loud sound may be produced suddenly that may damage the speaker or your hearing.

- (1) Turn on the devices connected to the [INPUT] connectors to the LM16.
- (2) Turn on the LM16.
- (3) Turn on the monitor amplifier (or powered monitor speaker).

Procedures of turning off the power after connecting peripheral devices

- (1) Turn off the monitor amplifier (or powered monitor speaker).
- (2) Turn off the LM16.
- (3) Turn off the devices connected to the [INPUT] connectors to the LM16.

Connection to external devices

Connection example (live stage)

<Note>: Before making connection between the LM16 and external devices, make sure that all devices including the LM16 are turned off, as well as all faders and level controls are down.

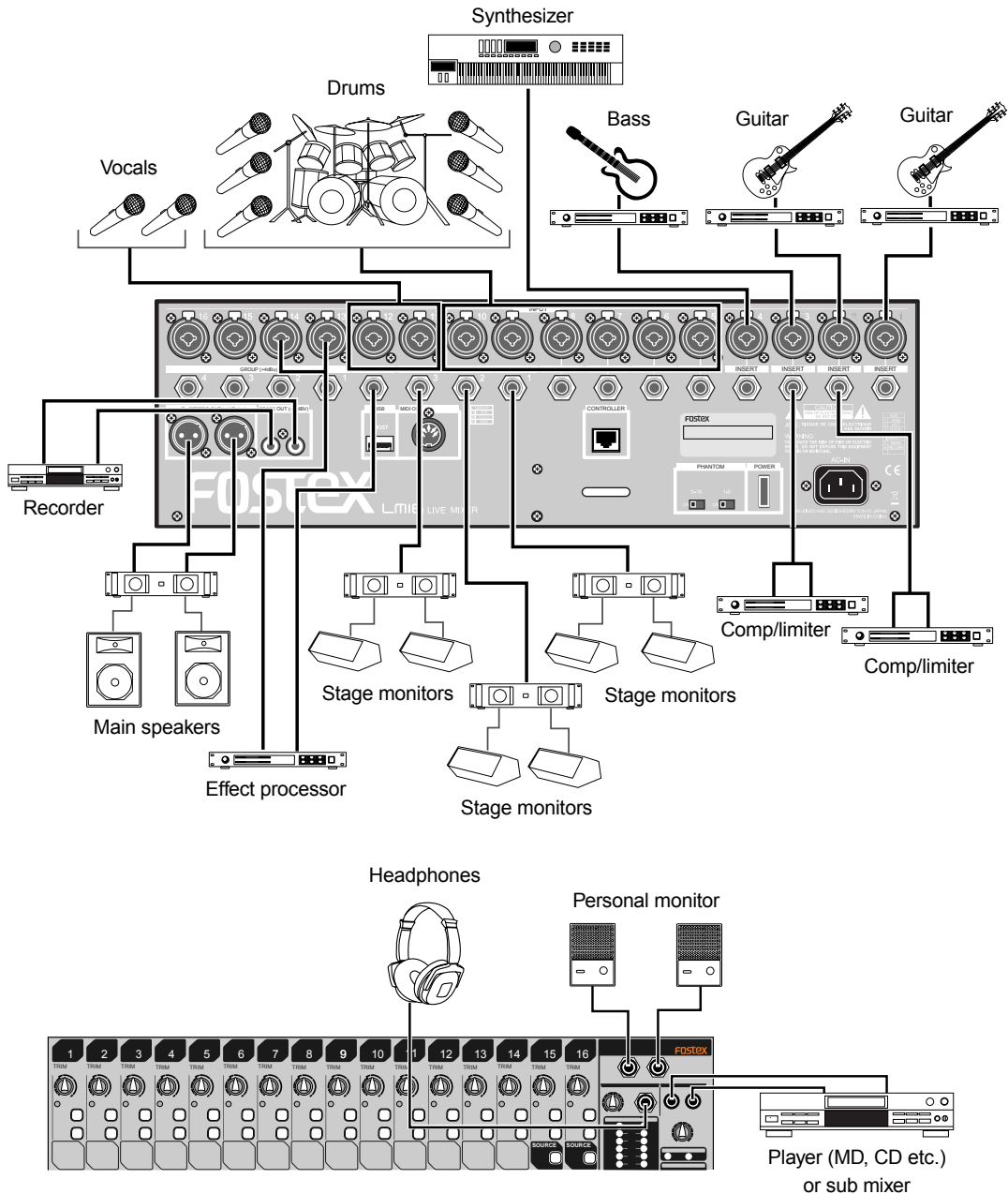

Connection example (home recording)

<Note>: Before making connection between the LM16 and external devices, make sure that all devices including the LM16 are turned off, as well as all faders and level controls are down.

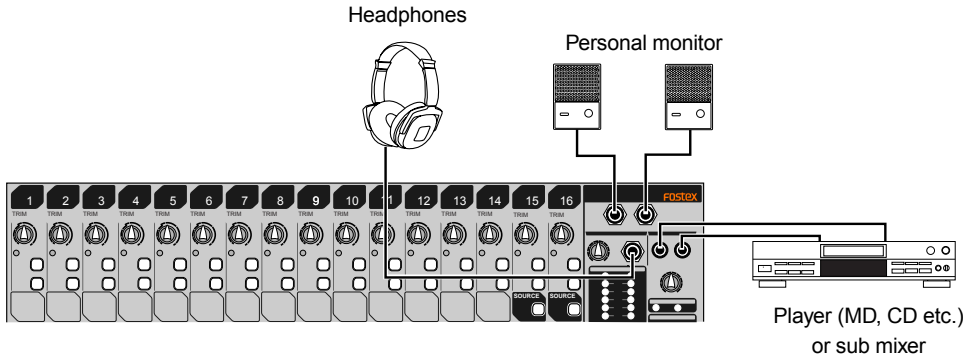
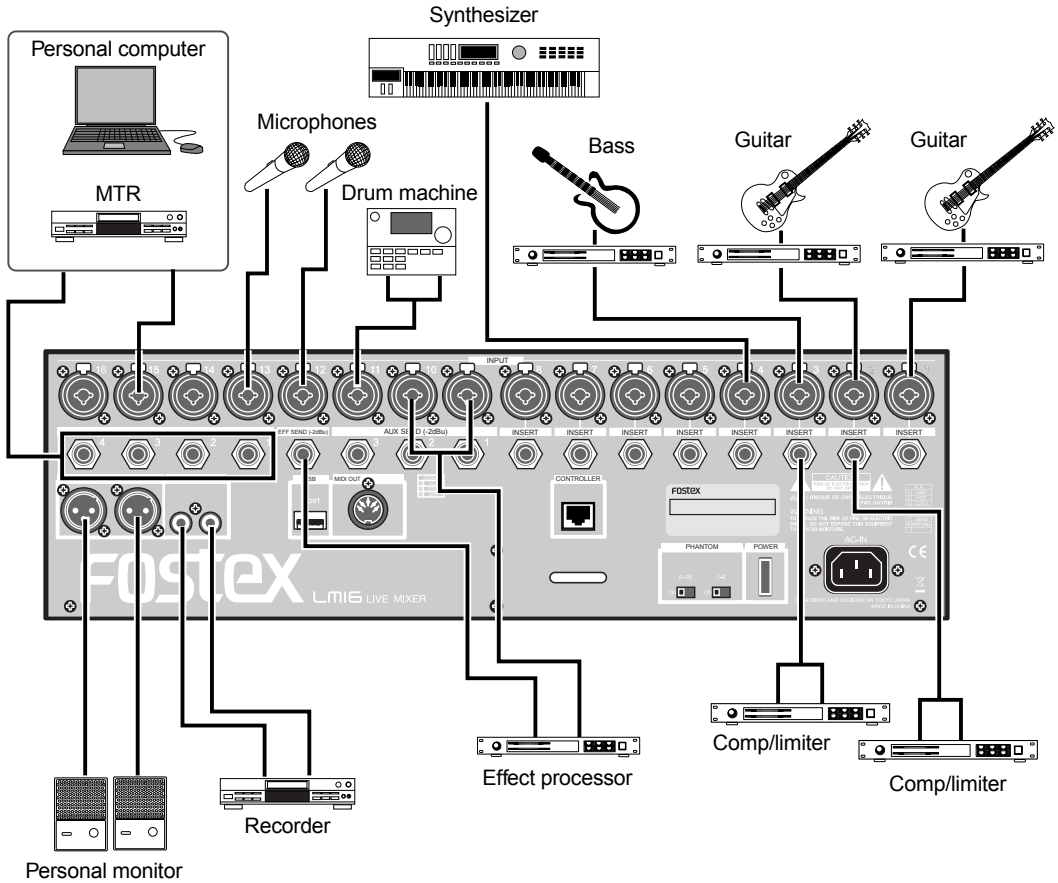

Balanced and unbalanced inputs/outputs

For connection between a recording mixer such as the LM16 and external devices (such as a microphone, keyboard, recorder, etc), shielded cables are used. There are two types of cables - balanced and unbalanced.

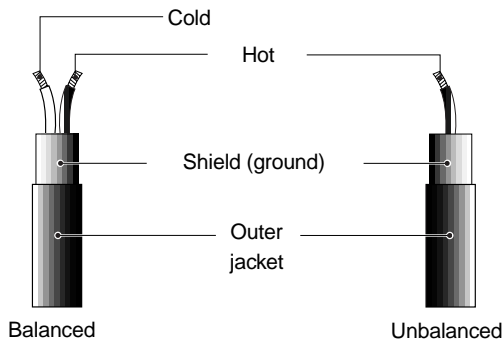

Balanced

The advantage of a balanced cable is its ability to reject external interference. Therefore, it is suitable for handling a small level signal or transferring over long distances. The LM16 provides the following balanced connectors.

Inputs/outputs	Connectable connectors
[INPUT 1-16]	XLR-3-12 connector, 3-conductor TRS or 2-conductor phone plug
[STEREO OUT (L, R)]	XLR-3-11 connector
[GROUP OUT 1 - 4]	3-conductor TRS phone plug
[PHONES]	3-conductor TRS phone plug

Unbalanced

An unbalanced cable is mainly used for handling line level signals. The LM16 provides the following balanced connectors.

Inputs/outputs	Connectable connectors
[INSERT 1 - 8]	3-conductor TRS phone plug
[EFF SEND]	2-conductor phone plug
[AUX SEND 1 - 3]	2-conductor phone plug
[ST MIX OUT (L, R)]	RCA pin plug
[MONITOR OUT (L, R)]	2-conductor phone plug
[SUB IN (L, R)]	RCA pin plug

Connector types																	
<p>XLR-3-11 connector (balanced)</p> <p>XLR-3-12 connector (balanced)</p>	<table border="1" style="margin: 10px auto;"> <tr><td>1</td><td>Ground</td></tr> <tr><td>2</td><td>Hot</td></tr> <tr><td>3</td><td>Cold</td></tr> </table>	1	Ground	2	Hot	3	Cold										
1	Ground																
2	Hot																
3	Cold																
<p>RCA pin plug (unbalanced)</p>	<table border="1" style="margin: 10px auto;"> <tr><td>Tip</td><td>Hot</td></tr> <tr><td>Sleeve</td><td>Ground</td></tr> </table>	Tip	Hot	Sleeve	Ground												
Tip	Hot																
Sleeve	Ground																
<p>3-conductor TRS phone plug (balanced)</p>	<p>INPUT/MON OUT AUX SEND/GROUP OUT EFF SEND</p> <table border="1" style="margin: 10px auto;"> <tr><td>Tip</td><td>Hot</td></tr> <tr><td>Ring</td><td>Cold</td></tr> <tr><td>Sleeve</td><td>Ground</td></tr> </table>	Tip	Hot	Ring	Cold	Sleeve	Ground										
Tip	Hot																
Ring	Cold																
Sleeve	Ground																
<p>2-conductor phone plug (unbalanced)</p>	<p>INSERT</p> <table border="1" style="margin: 10px auto;"> <tr><td>Tip</td><td>Output</td></tr> <tr><td>Ring</td><td>Input</td></tr> <tr><td>Sleeve</td><td>Ground</td></tr> </table> <p>PHONES</p> <table border="1" style="margin: 10px auto;"> <tr><td>Tip</td><td>L</td></tr> <tr><td>Ring</td><td>R</td></tr> <tr><td>Sleeve</td><td>Ground</td></tr> </table> <table border="1" style="margin: 10px auto;"> <tr><td>Tip</td><td>Hot</td></tr> <tr><td>Sleeve</td><td>Ground</td></tr> </table>	Tip	Output	Ring	Input	Sleeve	Ground	Tip	L	Ring	R	Sleeve	Ground	Tip	Hot	Sleeve	Ground
Tip	Output																
Ring	Input																
Sleeve	Ground																
Tip	L																
Ring	R																
Sleeve	Ground																
Tip	Hot																
Sleeve	Ground																

Names and functions

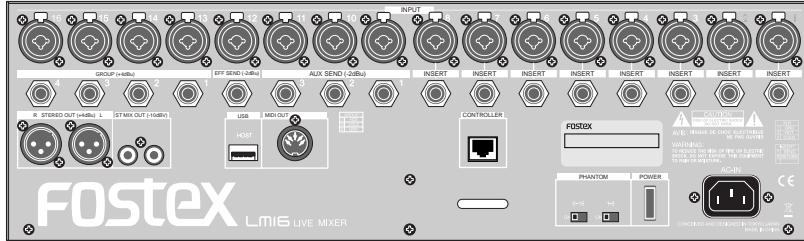

Main unit (Rear panel)



Control unit (Rear panel)

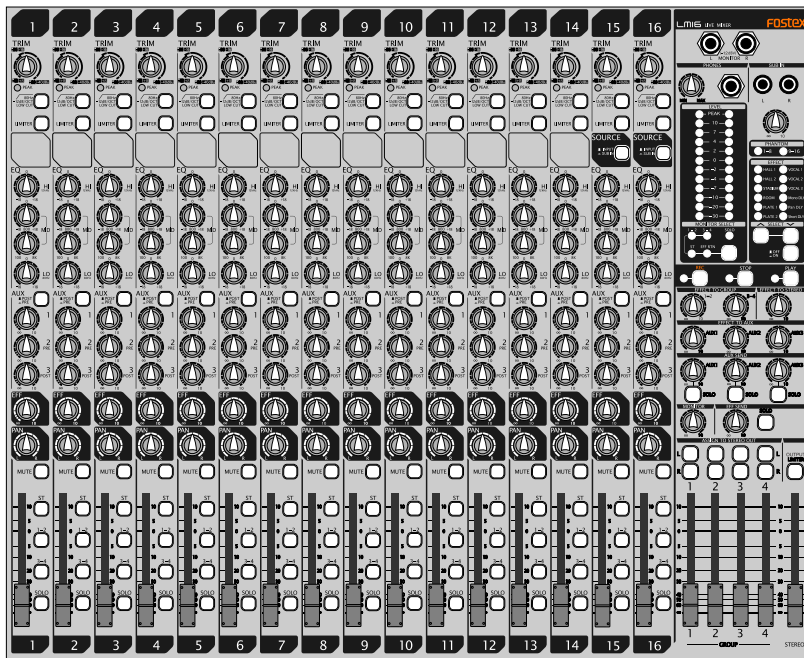

Control unit (Top panel)

Control unit (input channel 1 through 16)

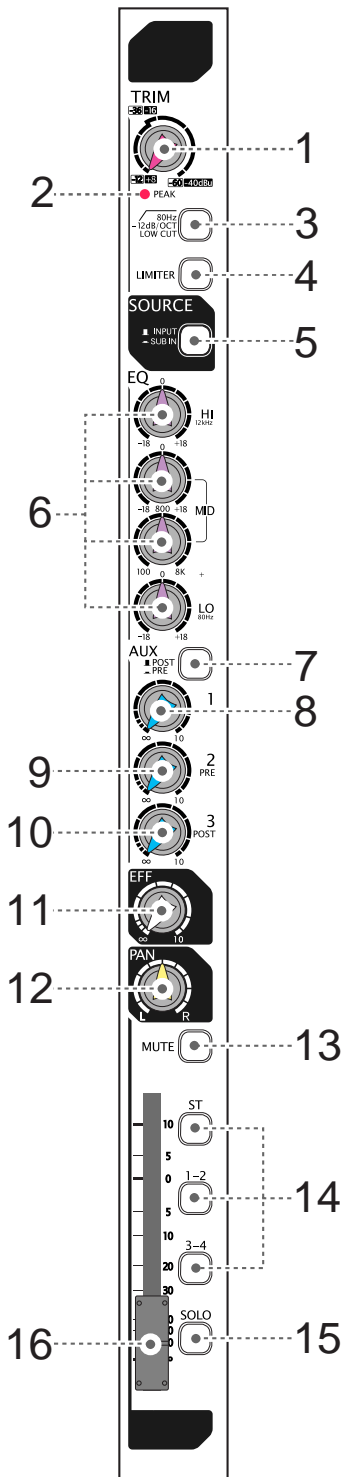

(1) [TRIM] control

Adjusts the gain of each input signal. Set this control appropriately so that the [PEAK] indicator lights at the maximum input level. By adjusting this control appropriately, the LM16 can accept a signal within -60dBu and -12dBu for mic input, while it can accept a signal within -40dBu and +8dBu for line input (see page 28 for details).

<Note>: When you set the [SOURCE] switch on each of channels 15 and 16 to "SUB IN" (⬇️), the [TRIM] control is not effective.

(2) [PEAK] indicator

Lights up when an input channel signal overloads. You should set the [TRIM] control appropriately so that this indicator does not light frequently (see page 28 for details).

(3) [LOW CUT] switch

Switches on (⬇️) or off (⬆️) of the low cut filter (high pass filter). When on, the frequency range below 80 Hz is cut at -12 dB/oct. This function is performed in the analog stage (see page 29 for details).

(4) [LIMITER] switch

Switches on (⬇️) or off (⬆️) of the limiter function. The limiter works to prevent signal clipping when the input level exceeds the certain level. The limiter function is performed in the analog stage (see page 29 for details).

(5) [SOURCE (INPUT/SUB IN)] switch

Available only on channels 15 and 16. It selects the channel input source (see pages 28 and 34 for details). When the switch is in the INPUT (⬆️) position, a signal from the [INPUT] connector is selected. When the switch is in the SUB IN (⬇️) position, a signal from the [SUB IN] jacks (L for channel 15, R for channel 16) is selected (each press of the switch alternates the input source). The input signal from the [SUB IN] L (or R) jack is level-adjusted using the [SUB IN] control and sent to the channel fader 15 (or 16) via the EQ section.

(6) [EQ HI/MID/LO] controls

These controls control gain for each EQ band (high, middle, and low), as well as the middle frequency. When you set the gain control at the center position, no boost or cut is applied (see page 29 for details).

The following table shows the EQ type, center (or cut-off) frequency and boost/cut range of each EQ band.

Band	EQ type	Center (or cut-off) frequency	Boost/cut range
HIGH	Shelving type	12kHz	+/-18dB
MID	Peaking type	100 Hz to 8 kHz (sweepable)	
LOW	Shelving type	80Hz	

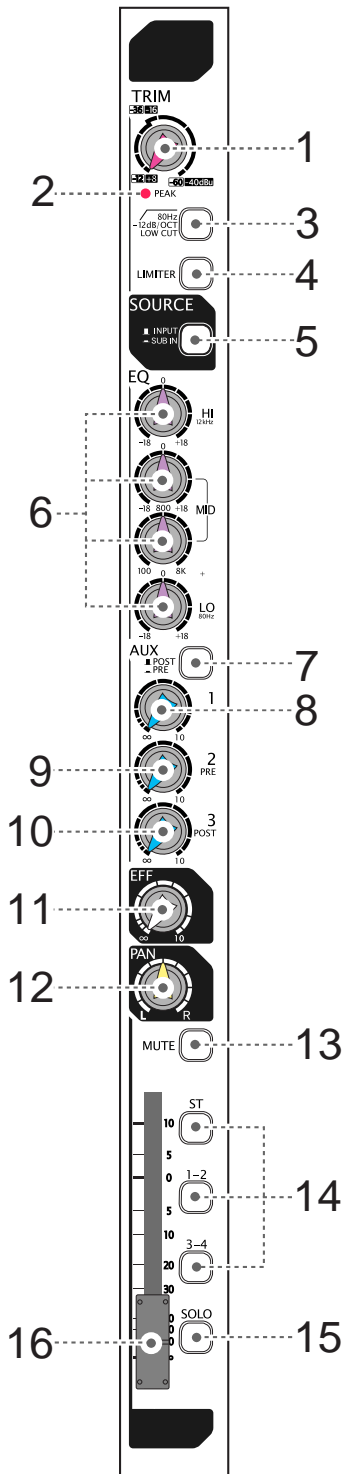

(7) [POST/PRE] switch

Selects post-fader or pre-fader feed of the AUX 1 buss (each press of the switch alternates the selection).

When the switch is set to the up (▲) position, post-fader is selected. When the switch is set to the down (▼) position, pre-fader is selected (see page 30 for details).

(8) [AUX 1] control

Adjusts the signal level fed to the AUX 1 buss from each input channel. The post-fader or pre-fader signal selected by the [POST/PRE] switch is fed to the AUX 1 buss (see page 30 for details).

(9) [AUX 2 (PRE)] control

Adjusts the signal level fed to the AUX 2 buss from each input channel. The pre-fader signal is fed to the AUX 2 buss.

(10) [AUX 3 (POST)] control

Adjusts the signal level fed to the AUX 3 buss from each input channel. The post-fader signal is fed to the AUX 3 buss.

(11) [EFF] send control

Adjusts the signal level fed to the EFF buss from each input channel. The post-fader signal is fed to the EFF buss, therefore, fader setting affects the signal sent to the [EFF] buss (see page 31 for details).

(12) [PAN] control

Determines the signal balance between the left and right of the stereo busses or odd and even busses of group buss pairs 1-2 and 3-4.

Rotating the control to the right (clockwise) increases the amount of the signal from the channel going to the right of the stereo buss, while decreases the amount of the signal going to the left of the stereo buss.

Rotating the control to the left (counterclockwise) increases the amount of the signal from the channel going to the left of the stereo buss, while decreases the amount of the signal going to the right of the stereo buss.

(13) [MUTE] switch

Switches the mute function on or off. When the switch is set to the down position (▼), the post fader signal of the channel is muted.

(14) [ST/1-2/3-4] assign switches

Assign or deassign the input channel signal to the corresponding buss pairs (Stereo, groups 1-2 or groups 3-4). When the switch is set to the down position (▼), the signal is assigned to the corresponding buss pair. You can assign the signal to more than one buss pair at the same time (see page 33 for details).

(15) [SOLO] switch

Switches the solo function on or off. When the switch is set to the down position (▼), the pre-fader signal can be monitored via the solo buss. When the [SOLO] switch on any input channel is set to ON, the [SOLO] indicator on the monitor section slowly flashes (see page 33 for details).

(16) Channel fader

Adjusts the output level of the input channel.

Control unit (Master channel)

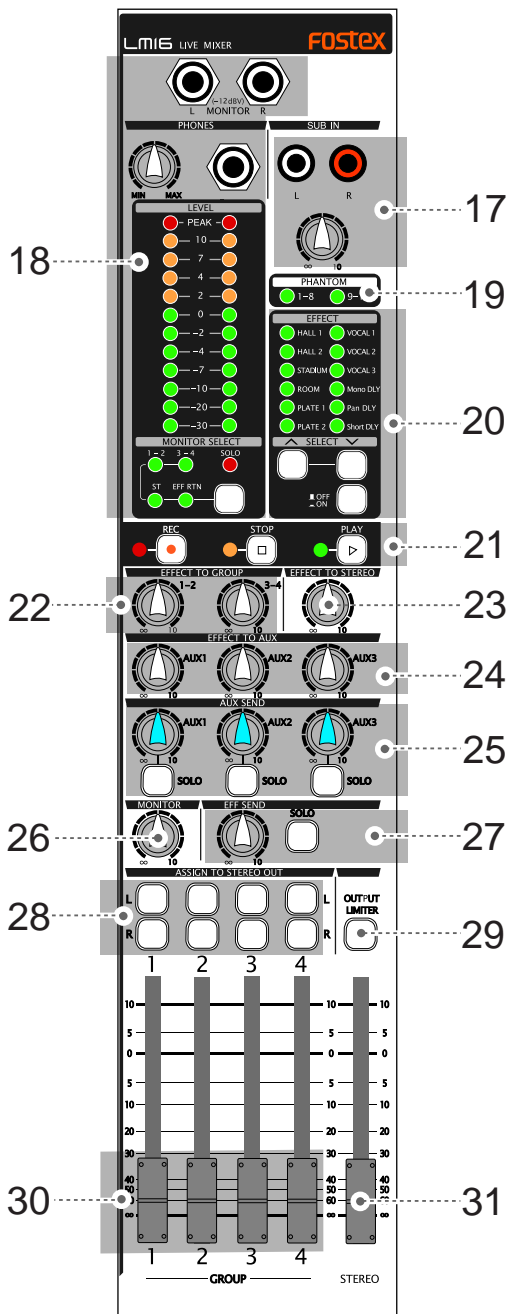

(17) [SUB IN] jacks / [SUB IN] control

You can connect the [SUB IN] jacks to a CD player, MD player, external mixer, etc., and use the [SUB IN] control to adjust the input level.

By setting the [SOURCE] switches on input channels 15 and 16 to the "SUB IN" position (➔), the signals from the [SUB IN] jacks are sent to these channels (L for channel 15, R for channel 16). See page 34 for details.

Note that the [TRIM] control on each of channels 15 and 16 does not affect the [SUB IN] signal.

(18) Monitor section

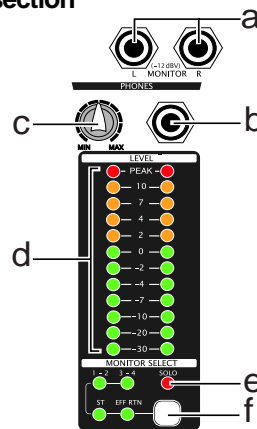

(a) [MONITOR L/R] jacks

You can connect a monitor amplifier or powered monitor speakers to these jacks. The output level can be adjusted by the [MONITOR] control.

(b) [PHONES] jack

Connects headphones. You can adjust the output level using the [PHONES] and [MONITOR] controls.

(c) [PHONES] control

Adjusts the output level of the [PHONE] jack.

(d) [MONITOR LEVEL] indicators

Indicate the output level of the monitor signal selected by the [MONITOR SELECT] switch (or the solo monitor signal).

(e) [SOLO] indicator

When at least one of the [SOLO] switches is set to ON, the [SOLO] indicator slowly flashes, while the solo monitor signal is output from the [MONITOR (L/R)] and [PHONES] jacks.

(f) [MONITOR SELECT] switch

Selects signals to be monitored. You can select from Groups 1-2, Groups 3-4, Stereo and Effect return by pressing the switch as many time as required. When solo monitor is active, the selection is not effective (see page 32 for details).

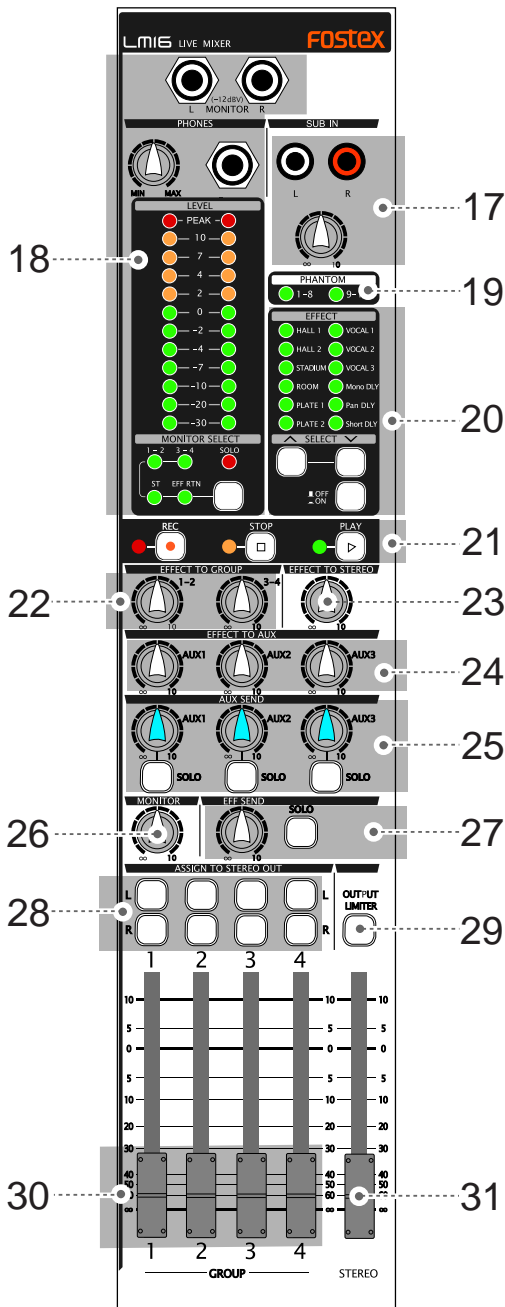

(19) [PHANTOM (1-8, 9-16)] indicators

Each indicator illuminates when the corresponding [PHANTOM] switch ([1-8] or [9-16]) is set to ON. The phantom power is supplied to the XLR connectors in eight input groups (see page 28 for details).

(20) Internal effects section

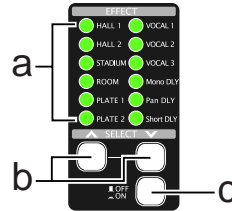

(a) [EFFECT] indicator

The current effect type selected by the [SELECT] ^/ v switches illuminates.

(b) [SELECT] up (^)/down (v) switches

Select an effect type (the indicator for the selected effect type illuminates).

When the [EFFECT] on/off switch is set to ON (■), the current effect is effective.

(c) [EFFECT] on/off switch

Switches the internal effects on (■) or off (■). When the switch is set to the down position (ON), the current effect selected by the [SELECT] ^/v switches is effective (see page 31 for details).

(21) Control section

Pressing a key in this section sends an MMC command to an external MIDI device connected to the [MIDI OUT] port (see page 40 for details).

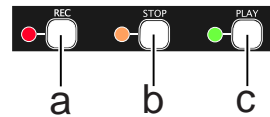

(a) [REC] key

Pressing the key sends the RECORD command to an external MIDI device for starting recording.

(b) [STOP] key

Pressing the key sends the STOP command to an external MIDI device for stopping recording.

(c) [PLAY] key

Pressing the key sends the PLAY command to an external MIDI device for starting playback.

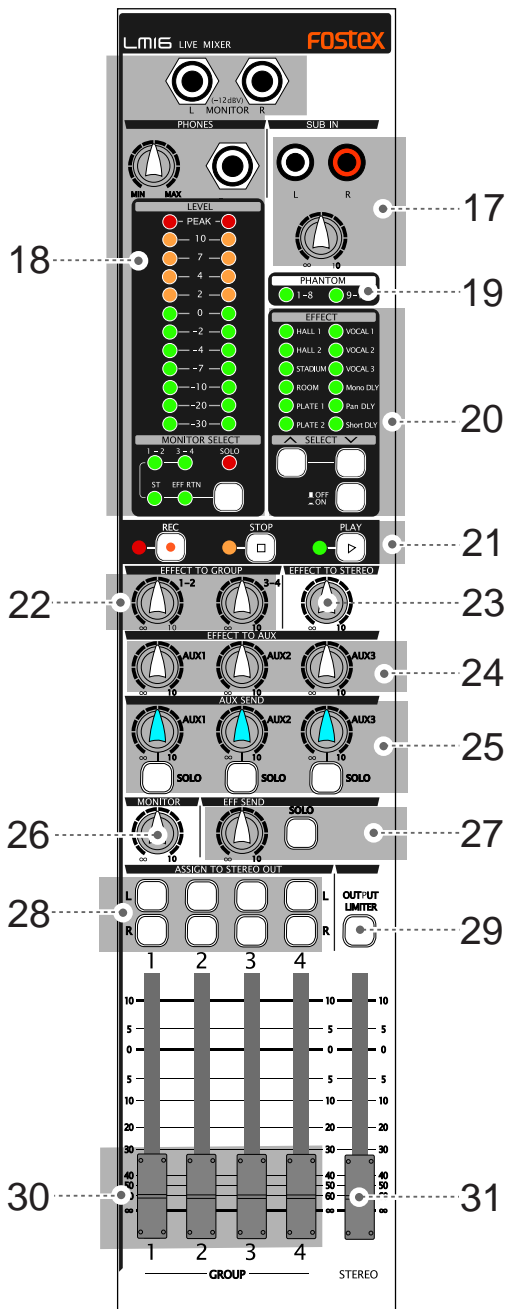

(22) [EFFECT TO GROUP] controls

Each control adjusts the output level from the internal effects to the corresponding group buss pairs (1-2 or 3-4). See page 31 for details.

(23) [EFFECT TO STEREO] control

Adjusts the output level from the internal effects to the stereo busses. See page 31 for details.

(24) [EFFECT TO AUX (1, 2, 3)] controls

Each control adjusts the output level from the internal effects to the corresponding AUX buss (1, 2 or 3). See page 31 for details.

(25) [AUX SEND] controls / [SOLO] switches

Each [AUX SEND] control adjusts the output level of the corresponding AUX SEND (1, 2 or 3) output. Each [SOLO] switch allows you to monitor the soloed signal of the corresponding AUX SEND (1, 2 or 3) output. When the switch is down, the solo function is engaged. Each press of the switch toggles between on and off (See page 30 for details).

(26) [MONITOR] control

Adjusts the output level of the [MONITOR (L/R)] and [PHONES] jacks. The output level of the [PHONES] jack is controlled by the [PHONES] and [MONITOR] controls (See page 32 for details).

(27) [EFF SEND] control / [SOLO] switch

Adjusts the output level of the EFFECT SEND . Each [SOLO] switch allows you to monitor the soloed signal of the EFFECT SEND output. When the switch is down (■), the solo function is engaged. Each press of the switch toggles between on and off.

(28) [ASSIGN TO STEREO OUT] switches

Each switch allows you to send the post signal of the corresponding GROUP fader to the [STEREO OUT L/R] jacks. When the switch is down, the signal is sent (See page 33 for details).

(29) [OUTPUT LIMITER] switch

Activates or deactivates the limiter function for all the buss outputs (stereo L/R outputs, group outputs 1 through 4, Aux send outputs 1 through 3, effect send output, and monitor outputs). When the switch is down (■), the limiter function is active.

(30) [GROUP 1-4] faders

Each fader adjusts the output level of the corresponding group output signal which is output from the [GROUP OUT] jack (See page 33 for details).

(31) [STEREO] fader

Adjusts the output level of the stereo output signal which is output from the [STEREO OUT (L/R)] and [ST MIX OUT (L/R)] jacks.

Control unit (rear panel)



(1) [TO CONTROLLER] connector

Used to connect to the [CONTROLLER] connector of the main unit using the supplied (or a different) CAT5 cable (See page 13 for details).

<Note>: Use only a CAT-5 STP cable (straight type) for connection between the main unit and the control unit.

Main unit (rear panel)

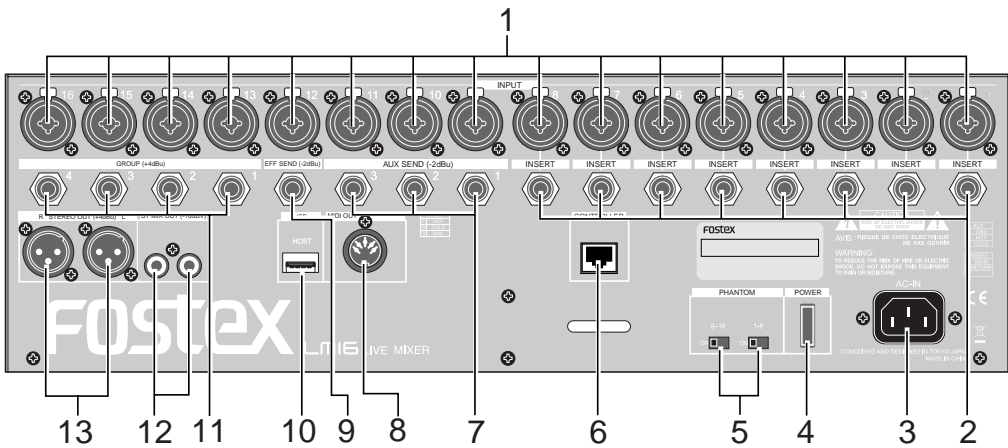

(1) [INPUT (1 through 16)] connectors

Each connector accepts a mic or line level analog audio signal.

The connector is a combo type - a combined XLR connector and phone jack in one. You can connect a microphone to the XLR connector or connect a line signal to the phone jack. (Note that you cannot use the XLR receptacle and phone jack on a same combo connector simultaneously.) See page 28 for details.

(2) [INSERT (1 through 8)] jacks

Each jack is used for connecting an external effects processor such as a compressor/limiter.

To connect an external effects processor, use a Y-cable as shown below (See page 31 for details).

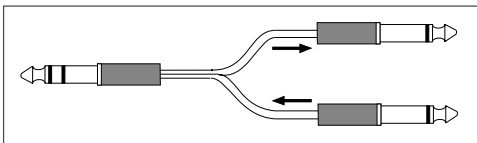

(3) [AC IN] connector

Used to connect the supplied power cord (See page 15 for details).

<Note>: Use only the supplied power cord. A different power cord may cause fire, etc. Also note that when you hear thunder rumbling, disconnect the power cord from the AC outlet.

(4) [POWER] switch

Turns on or off the LM16 (See page 15 for details).

<Note>: Do not turn off the LM16 while accessing the internal hard disk. Doing so may destroy data. Even if you turn off the LM16, it consumes a very small amount of power. Therefore, it is recommended to disconnect the power cord from the AC outlet if you do not use the LM16 for a long time.

(5) [PHANTOM (1-8, 9-16)] switches

You can supply phantom power to the XLR INPUT connectors in eight channel groups (1-8 and 9-16) using these switches.

When the [PHANTOM] switch is set to ON, the corresponding [PHANTOM] indicator on the control panel is illuminated (See page 28 for details).

(6) [CONTROLLER] connector

Used to connect to the [TO CONTROLLER] connector on the rear panel of the control unit using the supplied (or a different) CAT-5 cable (See page 13 for details).

(7) [AUX SEND (1, 2, 3)] jacks

Each of these unbalanced phone jacks outputs the corresponding AUX SEND buss signal at -2dBu nominal level. You can connect to a stage monitor, effects processor, etc (See page 16 for details).

(8) [MIDI OUT] port

Used to connect to the MIDI IN port of an external MIDI device.

From this port, MMC (MIDI Machine Control command) is output (See page 40 for details).

(9) [EFF SEND] jack

This unbalanced phone jack outputs the EFFECT buss signal at -2dBu nominal level.

You can connect to the input jack of an effects processor, etc (See page 16 for details).

(10) [USB HOST] port

By connecting a FAT16 or FAT32 USB memory stick to this port, you can also use the USB memory stick when upgrading the version (See page 37 for details).

(11) [GROUP OUT (1, 2, 3, 4)] connectors

These balanced phone jacks output the group buss signals at +4dBu nominal level.

You can connect these jacks to input connectors of an external mixer, etc (See page 16 for details).

(12) [ST MIX OUT (L, R)] jacks

These unbalanced RCA pin jacks output the stereo L and R buss signals.

You can connect these jacks to an external master recorder, etc (See page 16 for details).

(13) [STEREO OUT (L, R)] connectors

These XLR balanced connectors output the stereo L and R buss signals. You can connect these connectors to a power amplifier for driving main speakers on stage, etc (See page 16 for details).

Mixer basics

Signal flow of the mixer

A mixer accepts audio signals and modifies them, then mixes them.

The following diagram shows how the input signals flow through the mixer section of the LM16. As the diagram indicates, an analog signal from the [INPUT] connector is level-adjusted by the [TRIM] control and converted to digital, then sent to the channel fader via the EQ. After the channel fader, the pan control adjusts the left and right (or odd and even) balance of signal sent to stereo left and right busses (or odd and even group busses). Then the stereo signal is finally level-adjusted by the [STEREO] fader and output from the [STEREO OUT (L, R)] connectors.

A buss sums signals and mixes them. In the diagram below, busses are shown as pipes. The LM16 provides the following eleven busses: stereo busses (L, R), group busses (1, 2, 3, 4), AUX busses (1, 2, 3), effect buss and solo buss. Each buss sums signals. The mixed signal may be D/A converted and fed to an external device, or directly fed to the internal effects.

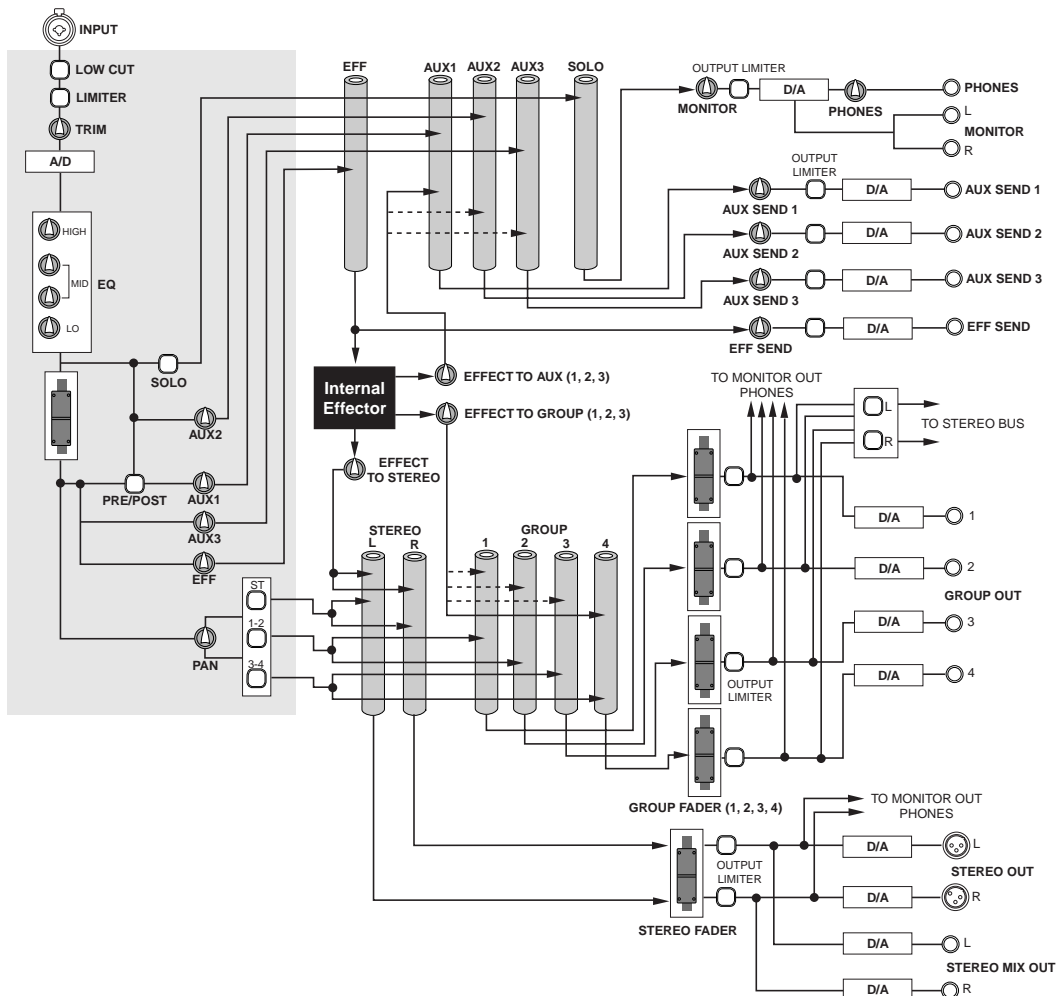

Connecting sources

• Connecting sources to the input connectors

Each of mixer channels 1 through 16 provides a combo type -- a combined XLR connector and phone jack in one. You can connect a microphone to the XLR connector or connect a line signal to the phone jack. (The phone jack can accept both balanced and unbalanced signals.)

You can adjust the input gain using the [TRIM] control on each mixer channel strip.

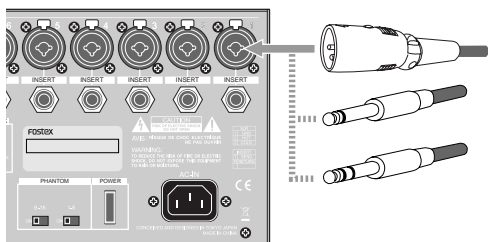

• Phantom power supply setting

48 V phantom power can be supplied to the XLR input connectors. For most of condenser microphones, the phantom power is required.

You can turn on or off phantom power using the [PHANTOM] switches in eight channel groups (1-8 and 9-16) using these switches.

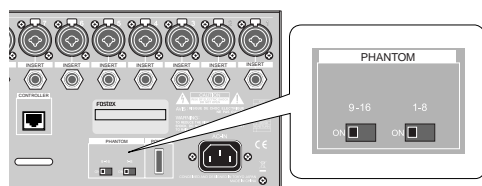

<Memo>: When the [PHANTOM] switch is set to ON, the corresponding [PHANTOM] indicator on the control panel is illuminated.



<Note>: When you turn off phantom power, the indicator is not immediately turned off, however, phantom power is immediately turned off.

<Note>: When you turn on the phantom power, make sure that the [TRIM] controls on the corresponding mixer channels are set fully left (minimum) or the LM16 is powered off.

Usually phantom power does not damage a dynamic microphone, however, do not connect an old ribbon microphone to an input connector to which phantom power is supplied.

• Selecting channel source

On each of input channels 15 and 16, the [SOURCE (INPUT/SUB IN)] select switch is provided. When the switch is in the INPUT (|) position, a signal from the [INPUT] connector is selected. When the switch is in the SUB IN (←) position, a signal from the [SUB IN] jacks (L for channel 15, R for channel 16) is selected (see page 34 for details).

Adjusting the input level

The [TRIM] control adjust the head amp gain of each input signal. To get the optimum gain, set this control appropriately so that the [PEAK] indicator lights at the maximum input level.

By adjusting this control appropriately, the LM16 can accept a signal within -60dBu and -12dBu for an XLR connector is connected, while it can accept a signal within -40dBu and +8dBu when a phone plug is connected.

<Memo>: It is important to set the [TRIM] control appropriately. Otherwise, the signal may be distorted or noisy.

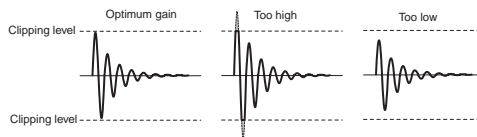

<Note>: The [TRIM] control the gain of the head amplifier with a two-stage pre-amp and there is a point where the gain is switched (at approx. -35 dBu for XLR input, -15 dBu for phone input). At this point, a noise may be generated.

<Gain adjustment while monitoring>

To adjust the gain while monitoring an input signal, connect headphones to the [PHONES] jack (or connect a powered monitor speaker to the [MONITOR OUT] jacks) and rotate the [PHONES] control (or [MONITOR] control) little to the right from the leftmost position. In this condition, perform the following.

- 1) Press the [SOLO] switch on the mixer channel to solo the channel.
- 2) Input the source sound (from a microphone or line).
- 3) Rotate the [PHONES] control (or [MONITOR] control) clockwise gradually.
- 4) Adjust the [TRIM] control to get the optimum gain.
- 5) After adjusting the gain, press the [SOLO] switch to de-solo the channel.

• Low-cut filter

The low-cut filter is often known as a high-pass filter. It passes high frequencies and eliminates low frequencies.

By pressing the [LOW CUT] switch to set to "ON" (—), the ultra low frequencies under 80 Hz are eliminated with a -12 dB/octave slope.

The low-cut filter helps prevent wind noise, mic handling noise, etc. It is recommended to enable the low-cut filter when you connect a microphone.

• Limiter

The limiter can be used to prevent clipping when a too hot signal is input.

The limiter does not work as far as an input signal is below the threshold level. When the input signal exceeds the threshold level, it reduces or attenuates the input signal thereby holding the output signal level too high.

The output limiter provided in the master section is effective to prevent damaging the main speakers in live or PA applications.

Equalizer

You can tailor the sound using the channel equalizer. For best results, the equalizer should be used to make the sound natural.

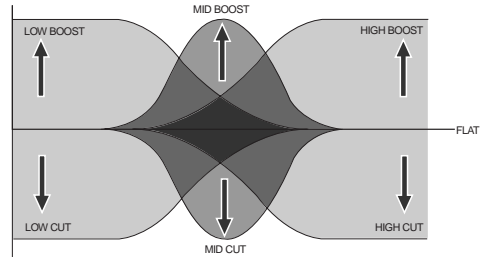

<Note>: You can equalize the pre-fader signal which is not affected by the channel fader.

<Memo>: In general, the range of frequency of sound that human beings can hear is about 20 Hz to 20 kHz. The following shows the frequency ranges of instruments and vocals.

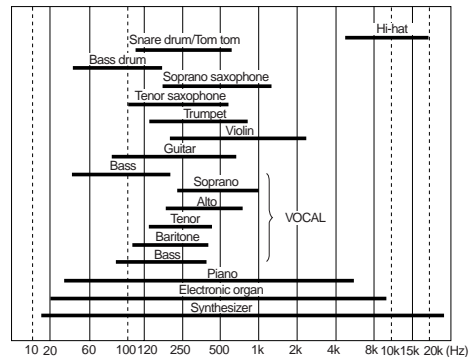
**<Tips for equalizing>**

If the mixed sound is not clear, we recommend to find the channel which makes the mixed sound unclear and slightly cut the frequency range of the channel. Too much boosting may make the mixed sound unclear.

Listen to the mixed sound repeatedly, comparing with the original (non-EQ) sound, and challenge to make your favorite sound.

Using of low-cut filter may be effective when you use a microphone.

EQ HIGH

The EQ HIGH is a shelving type EQ which provides up to 18 dB of boost or cut above 12 kHz. The center detent position of the control is the flat position. You can emphasize a cymbal or sharpen a vocal, keyboard or guitar by boosting the EQ HIGH. You can soften the high frequency sound by cutting the EQ HIGH.

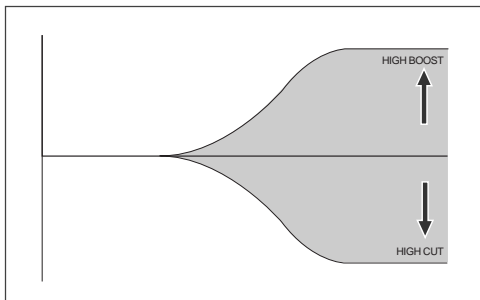

EQ MID

The EQ MID is a peaking type EQ which provides up to 18 dB of boost and cut at the center frequency. You can sweep the center frequency between 100 Hz and 8 kHz. The center detent position of the control is the flat position. For most of sound sources, the mid frequency range absolutely effects the sound. Therefore, you can dramatically tailor the sound using the EQ MID.

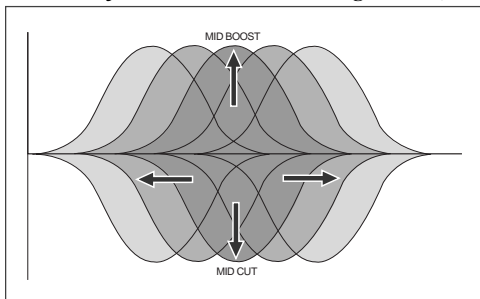

EQ LO

The EQ LO is a shelving type EQ which provides up to 18 dB of boost or cut below 80 Hz. The center detent position of the control is the flat position. You can emphasize a kick, guitar, bass, etc.

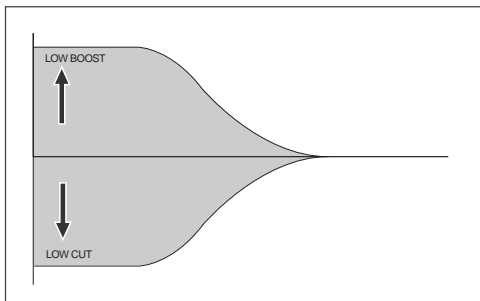

Using an external effect processor

• Using AUX 1, 2 and 3

You can use AUX busses for sending channel signals to an external effects processor or stage monitor, etc.

The [AUX] send control on each mixer channel adjusts the amount of the channel signal sent to the AUX buss. The signal after the [AUX SEND] control in the master section which adjusts the total AUX buss level is output from the [AUX SEND] jack.

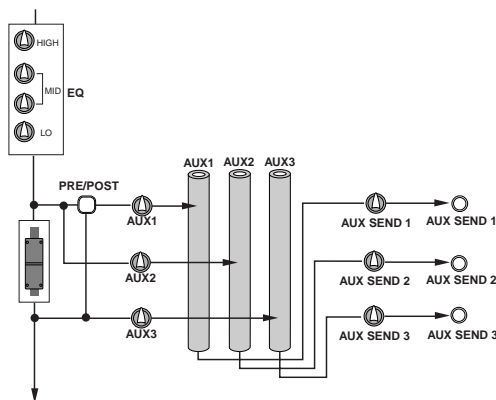

There are two send signal types - pre-fader and post-fader. You can select pre- or post-fader for the AUX 1 buss. The AUX 2 buss is fixed to pre-fader, while the AUX 3 buss is fixed to post-fader.

In general, you send a post-fader signal to an effects processor, while you send a pre-fader signal for stage monitoring.

Pre-fader

A channel signal before the channel fader is sent to the buss. You can make a mix which is completely independent from the main mix. Pre-fader AUX sends are generally used for the monitor mix, because the channel faders don't affect the AUX send signals.

Any adjustments made to the front-of-the-house mix don't affect the balance heard by the performers onstage.

Post-fader

A channel signal after the channel fader is sent to the buss. Post-fader Aux sends are generally used for connecting to external effects processors. The send signal is raised or lowered according to the channel fader.

• Using Insert

The [INSERT] jack, as well as the AUX post send, is used for connecting to an external processor. Unlike the AUX send, you can apply effects to a single channel signal.

The LM16 provides the [INSERT] jacks for mixer channels 1 through 8. Each jack is used mainly for connecting a compressor, limiter, equalizer, etc.

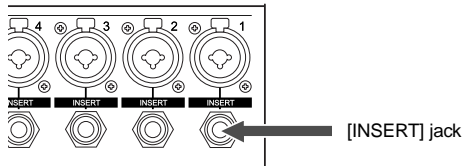

By connecting an external effect processor to the [INSERT] jack, you can send the channel signal to the processor and receive the processed signal.

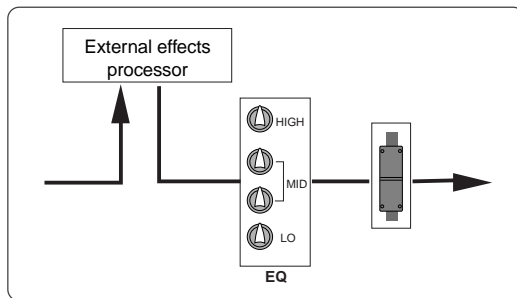

The [INSERT] jack on the LM16 is the TRS-type unbalanced phone jack. You can make bidirectional connection with the effect processor using a "Y" cable as shown below.

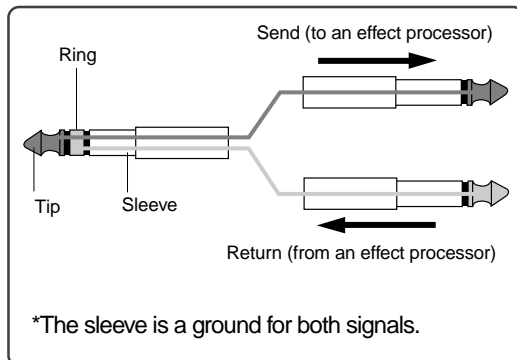

Using the internal effects processor

The LM16 features the internal effects (reverb/delay) processor, which allows applying effects to the mixer channel signals.

The effect send signal of each channel is adjusted by the [EFF] control after the channel fader. The effected (wet) signal is adjusted using the controls in the [EFFECT TO STEREO], [EFFECT TO GROUP] and [EFFECT TO AUX] sections and sent to the stereo, group and AUX busses.

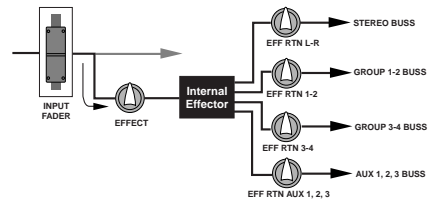

• Applying the internal effects

The following shows how to send the effected (wet) signal from the internal effects processor to the stereo L/R buss.

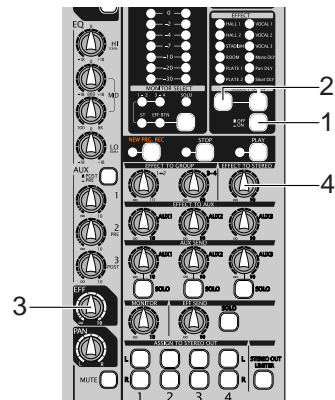

- (1) Set the [EFFECT] ON/OFF switch to "ON" (—).
- (2) Select the desired effect type using the [SELECT] ^/v switch. The indicator for the selected type is illuminated. (See the next page for details about each effect type.)
- (3) Adjust the effect send level of the channel signal using the [EFF] control on each mixer channel. Note that the effect send level is affected by the channel fader.

- (4) **Adjust the effected (wet) signal level sent to the stereo L/R buss using the control in the [EFFECT TO STEREO] section**
 Adjust the effected signal level while monitoring the stereo buss signal using headphones or monitor speakers.

<Memo>: To send the effected signal to the group or AUX busses, use the controls in the [EFFECT TO GROUP] or [EFFECT TO GROUP] section.

• **About the effect types**

HALL 1	Standard hall reverb; detailed and transparent, with a moderate amount of early reflections.
HALL	Stadium reverb characterized by long early reflections.
STADIUM	Reverb simulating an auditorium with suppressed reverberation.
ROOM	Room reverb simulating a moderate space with some sparkle.
PLATE 1	Modem-sounding plate reverb with wide bandwidth.
PLATE 2	Plate reverb with a gentle character.
VOCAL1	All-purpose hall reverb with no early reflections, and uniform decay at all frequencies.
VOCAL 2	Plate-like reverb is added to a spacious short delay. This blends well with any genre of music.
VOCAL 3	All-purpose reverb (karaoke style) that makes any vocal sound professional.
Mono DLY	Mono delay.
Pan DLY	Panning delay.
Short DLY	Short delay.

Monitoring

You can monitor the signal using headphones via the [PHONES] jack or using monitor speakers via the [MONITOR L/R] jacks.

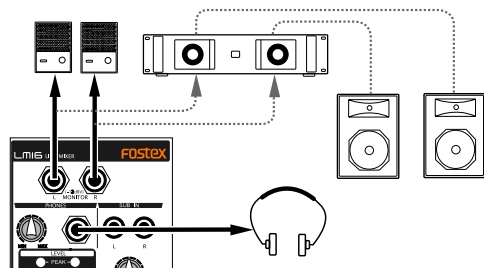

The signal to be monitored can be selected using the [MONITOR SELECT] switch. Each press of the switch changes the monitor signals and the indicator for the current monitor signal (ST, 1-2, 3-4 or EFF RTN) is lit.

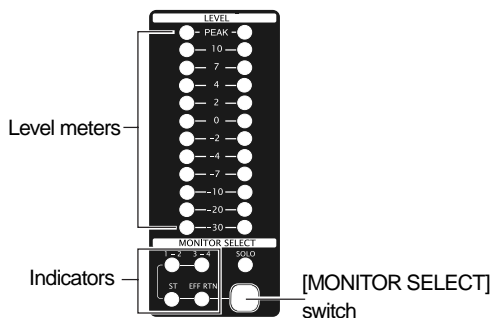

ST	You can monitor the stereo L and R buss signal, which is output from the [STEREO OUT (L, R)] jacks.
1-2	You can monitor the group 1 and 2 buss signals, which are output from the [GROUP (1, 2)] jacks.
3-4	You can monitor the group 3 and 4 buss signals, which are output from the [GROUP (3, 4)] jacks.
EFF RTN	You can monitor the output signal (wet signal) of the internal effects processor.

The output level of the [PHONES] jack is controlled by the [MONITOR] and [PHONES] controls, while the output level of the [MONITOR L/R] jacks is controlled by the [MONITOR] control. The output levels of the monitoring signals are shown on the level meters above the [MONITOR SELECT] switch.

<Note>: If any of the [SOLO] switches is set to ON, the solo signal is monitored, while the signal selected by the [MONITOR SELECT] switch is interrupted.

• Solo monitor

By setting the [SOLO] switch(es) to ON (▲), you can solo monitor the corresponding channel signal(s).

If at least one of the [SOLO] switches is set to ON, the [SOLO] indicator slowly flashes.

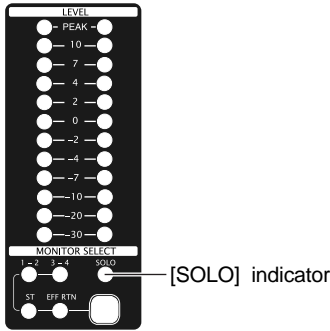

You can find the [SOLO] switches on channels 1 through 16, the effect send, and AUX sends 1 through 3 (see below).

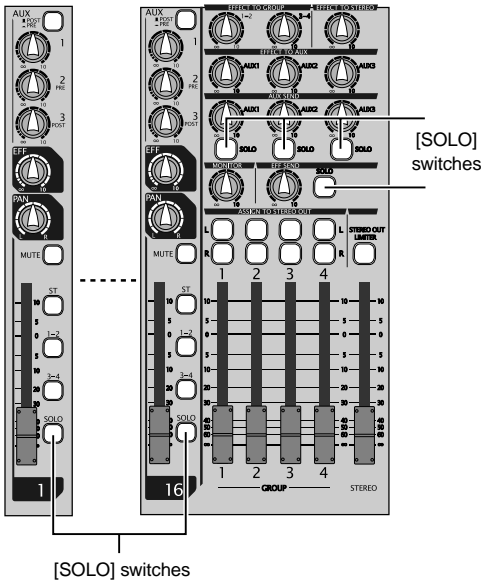

<Note>: If any of the [SOLO] switches is set to ON, the solo signal is monitored, while the signal selected by the [MONITOR SELECT] switch is interrupted.

Channel grouping

You can group channels to group busses for effective mixing.

Using the channel grouping function, you can adjust levels of grouped channels using a single fader while maintaining the balance between channels.

By setting the group assign switch (1-2 or 3-4) of a channel to ON, the channel signal is sent to group busses 1 and 2 or 3 and 4. A group buss signal is output from the [GROUP OUT] jacks.

When the [ASSIGN TO STEREO OUT] switch above the group fader is set to ON, the group buss signal is output to the corresponding stereo buss.

For example, it would be a good idea to assign channels for drums to a group. You can control the level of drums using the corresponding group fader without altering the balance.

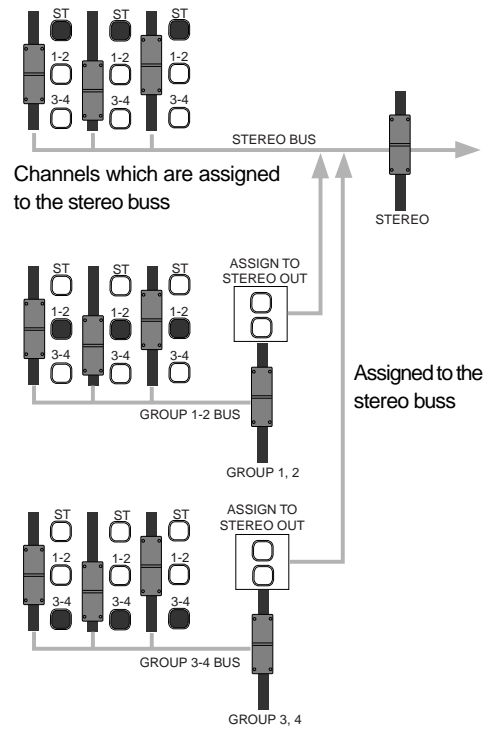

Channels which are assigned to the group busses

Using SUB IN

You can connect a stereo audio source such as a CD player, MD player, etc., to the [SUB IN (L, R)] jacks and output it from the mixer's output. Therefore, you can connect a BGM source and play it back during a break in the show, etc.

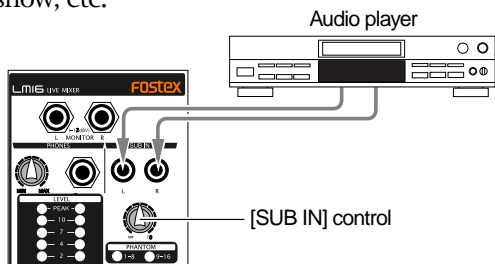

By setting the [SOURCE] switches on input channels 15 and 16 to the "SUB IN" position (⬇️), the signals from the [SUB IN] jacks are sent to these channels (L for channel 15, R for channel 16). Use the [SUB IN] control to adjust the input level. (Note that the [TRIM] control on each of channels 15 and 16 does not affect the [SUB IN] signal.)

The following shows the setting example for playing back the signals from the [SUB IN] jacks by the main speakers of a live stage.

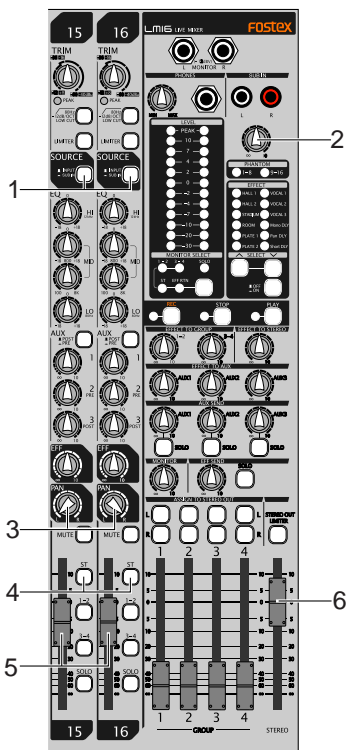

- (1) **Set the [SOURCE] switches on channels 15 and 16 to "TRK" (⬇️).**
The input signals from the [SUB IN] jacks are selected as the sources of channels 15 and 16.
- (2) **Use the [SUB IN] control to adjust the level of the signals from the [SUB IN] jacks.**
You can use the [SUB IN] control to adjust the level of the signals from the [SUB IN] jacks, but cannot use the [TRIM] control for them.
- (3) **To output the signals from the [SUB IN] jacks in stereo, set the [PAN] control on channel 15 to "L" and set the [PAN] control on channel 16 to "R".**
- (4) **Set the [ST] assign switches on channels 15 and 16 to "ON" (⬇️).**
The signal from the [SUB IN] jacks is routed to the stereo L/R buss.
- (5) **Use the channel faders on channel 15 and 16 to control the output level of the channel signals sent to the stereo L/R buss.**
- (6) **Use the [STEREO] faders on channels 15 and 16 to control the level of the stereo buss signal output from the [STEREO OUT (L, R)] connectors, which affects the main speaker volume.**

<Memo>: The [SUB IN] jacks can be used to increase the total number of inputs by connecting to a sub mixer.

Block diagram

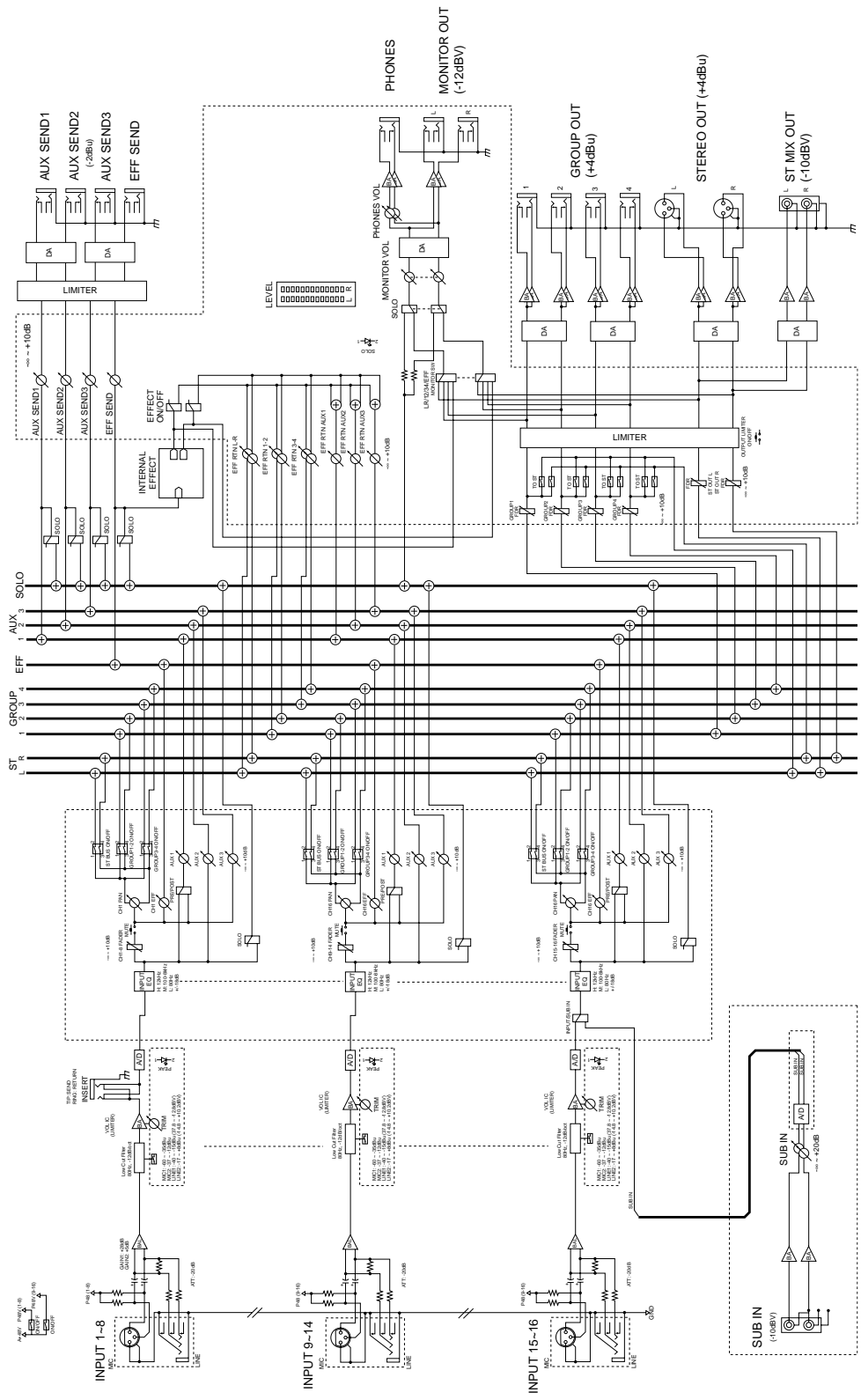

Upgrading the software

Checking the current software version

You can check the current software version by the following procedure.

- (1) Turn off the power of the unit.
- (2) Disconnect the CAT-5 cable that connects the main and control units.
You only have to disconnect either end of the cable.
- (3) Turn on the power of the unit.
- (4) After ten or more seconds from turning on the power, connect the CAT-5 cable again.

After the communication between the main and control units is made, the version information of the main unit is shown. The [PEAK] indicators for the input channels on the control (mixer) unit shows the date, while the level meters shows the version number (see the next section for details about how to show these information). While the current software version is shown, the indicator for the [STOP] key flashes.

<Memo>: By pressing the [∨] switch, the version information of the control unit is shown. Pressing the [∧] switch returns to show the version information of the main unit. If you do not press the [∨] or [∧] switch for more than five seconds after the version information appears, the LM16 automatically stops showing the version information. While you keep pressing the [∨] or [∧] switch, the LM16 keeps showing the version information.

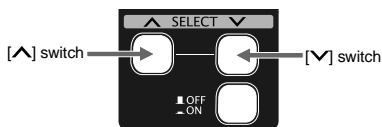

While the version information of the main unit is shown, the [PHANTOM 1-8] indicator lights. While the version information of the control unit is shown, the [PHANTOM 9-16] indicator lights.

- (5) To dismiss version information manually, press the [STOP] key.

• Showing date information

Data information of the version is shown using the [PEAK] indicators for the input channels.

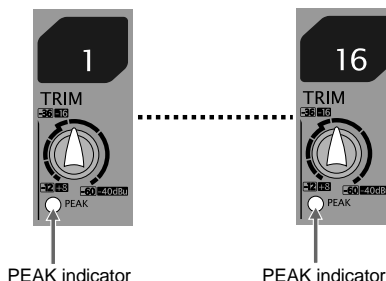

Data information (year, month, day) is shown in four-digit hexadecimal. The following shows the examples of how to show the "14 March 2009".

Date															
0	3	1	4												
BCD															
0	0	0	0	0	0	1	1	0	0	0	1	0	1	0	0
Lighting peak indicators on input channels															
1	2	3	4	5	6	7	8	9	10	11	12	13	14	15	16
Number								BCD							
0	0	0	0	0	0	0	0	0	0	0	0	0	0	0	0
1	0	0	0	0	0	1	0	0	0	0	1	0	0	0	0
2	0	0	0	1	0	0	0	0	0	1	0	0	0	0	0
3	0	0	1	0	0	0	0	0	0	1	1	0	0	0	0
4	0	1	0	0	0	0	0	0	1	0	0	0	0	0	0
5	0	1	0	0	1	0	0	0	1	0	1	0	0	0	0
6	0	1	1	0	0	0	0	0	1	1	1	0	0	0	0
7	0	1	1	1	0	0	0	0	1	1	1	1	0	0	0
8	1	0	0	0	0	0	0	1	0	0	0	0	0	0	0
9	1	0	0	0	1	0	0	1	0	0	0	1	0	0	0

• Showing version information

The software version information is shown using the level indicators.

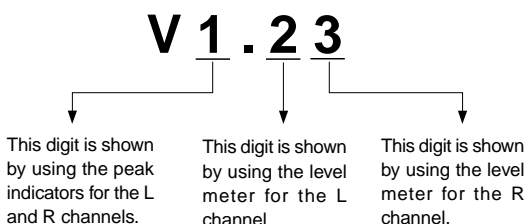

• **L and R peak indicators**

Depending on the major version number, each of the L and R peak indicators is lit or unlit as shown in the table below.

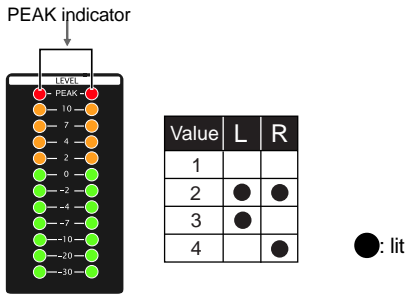

• **L and R meters (between 7 and -30)**

The L meter shows the minor version number (the second digit), while the R meter shows the sub minor version (the third digit). See the table below for the relation between the number and the lighting condition.

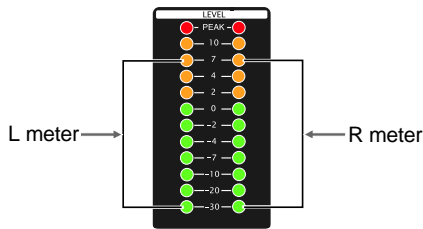

No.	0	1	2	3	4	5	6	7	8	9
7										●
4									●	●
2								●	●	●
0						●	●	●	●	●
-2					●	●	●	●	●	●
-4				●	●	●	●	●	●	●
-7			●	●	●	●	●	●	●	●
-10		●	●	●	●	●	●	●	●	●
-20	●	●	●	●	●	●	●	●	●	●
-30	●	●	●	●	●	●	●	●	●	●

●: lit

<Example>: The following shows the meter condition when the current version is "Version 1.23".

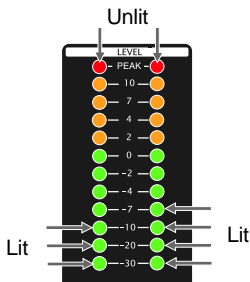

How to upgrade the version

The following explains how to upgrade the software version.

You can download the upgraded software (latest version) from the FOSTEX website (<http://www.fostex.com/>). After downloading the file, copy it to a USB memory stick. (The downloaded file has the file extension ".mot". See the FOSTEX website for details about downloading.)

<Note>: If you cannot download the software file from the FOSTEX website, ask your local FOSTEX dealer or service station.

- (1) Turn on the power of the unit.
- (2) Connect the USB memory stick to which you copied the downloaded file to the [USB (HOST)] port.

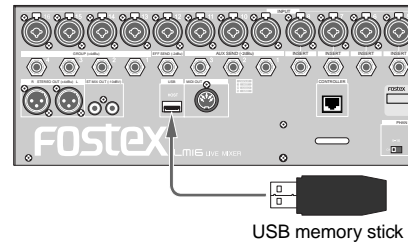

After reading the file information, the unit enter the version upgrade mode and shows the version information (version number and date) of the file using the [PEAK] indicators on input channels as well as the L and R meters and peak indicators, while the [STOP] and [REC] indicators start flashing. (See the previous section for details about how the information is shown.)

<Note>: To cancel performing upgrade, press the [STOP] key while the [STOP] and [REC] indicators are flashing. The unit exits the upgrade mode.

- (3) Press the [REC] key. The unit performs upgrade. When upgrade is completed, the system automatically restarts the unit.

<Memo>: While performing upgrade, the [PEAK] indicators of all channels are lit. While performing upgrade of the main unit, the [PHANTOM 1-8] indicator slowly flashes. While performing upgrade of the control unit, the [PHANTOM 9-16] indicator slowly flashes.

Specifications

Inputs/Outputs

0dBV = 1.0 Vrms, 0dBu = 0.775 Vrms
Reference level: -20dBfs

Input and Output (Main unit)

[MIC INPUT (1 - 16)]

Connectors: XLR3-31, balanced (combo)
Nominal input level: -60dBu ~ -12dBu
Input impedance: more than 1.5kΩ
Phantom Power: P48V (1-8ch & 9-16ch switchable, on/off)

[LINE INPUT (1 - 16)]

Connectors: ø6.3mm TRS phone, balanced (combo)
Nominal input level: -40dBu ~ +8dBu
Input impedance: more than 10kΩ

[INSERT (1 - 8)]

Connectors: ø6.3mm TRS phone, (Tip: Output, Ring: Input)
Load impedance: more than 10kΩ
Nominal output level: -10dBV
Input impedance: more than 10kΩ
Nominal input level: -10dBV

[STEREO BUS OUT (L, R)]

Connectors: XLR3-31, balanced
Reference output level: +4dBu
Load impedance: more than 10kΩ

[GROUP BUS OUT (1 - 4)]

Connectors: ø6.3mm TRS phone, balanced
Reference output level: +4dBu
Load impedance: more than 10kΩ

[AUX SEND (1 - 3)]

Connectors: ø6.3mm phone, unbalanced
Reference output level: -2dBu
Load impedance: more than 10kΩ

[EFFECT SEND]

Connector: ø6.3mm phone, unbalanced
Reference output level: -2dBu
Load impedance: more than 10kΩ

[STEREO MIX OUT (L, R)]

Connectors: RCA, unbalanced
Reference output level: -10dBu
Load impedance: more than 10kΩ

[USB (HOST)]

Device: USB2.0 Hi-speed for storage connection
Connector: A type

[MIDI OUT]

Connector: DIN 5-pin

[TO CONTROL BOX]

Connector: RJ45 (CAT-5, straight)

Input and Output (Control unit)

[PHONES]

Connector: ø6.3mm Stereo Phone
Load impedance: more than 32Ω

[MONITOR OUT (L, R)]

Connector: ø6.3mm Phone, unbalanced
Reference output level: -12dBV
Load impedance: more than 32Ω

[SUB IN (L, R)]

Connector: RCA, unbalanced
Reference input level: -10dBV
Input impedance: more than 10kΩ

[TO I/O BOX]

Connector: RJ45 (CAT-5, straight)

Others

Frequency response: 20Hz - 20kHz +1dB, -2dB (44.1/48kHz)

S/N: Line (Trim Min) 103dB (Typical)
Mic (Trim Max) 83dB (Typical)

Dynamic range: 103dB (Trim Min) (Typical)

T.H.D.: Mic (Trim Max) -> ST out: 0.01% (1kHz, -2dBFS) (Typical)
Line (Trim Min) -> ST out: 0.005% (1kHz, -2dBFS) (Typical)
Line (Trim Min) -> Phones: 0.1% or less (1kHz, 50mW, 32Ω)

General

Dimensions: 482 (W) x 136 (H) x 570 (D) mm

Weight: approx. 10kg

Power Requirement: 120VAC 50/60Hz
230VAC 50/60Hz
240VAC 50/60Hz

Power Consumption: approx. 33W

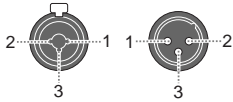

1	GND
2	HOT
3	COLD

Physical dimensions

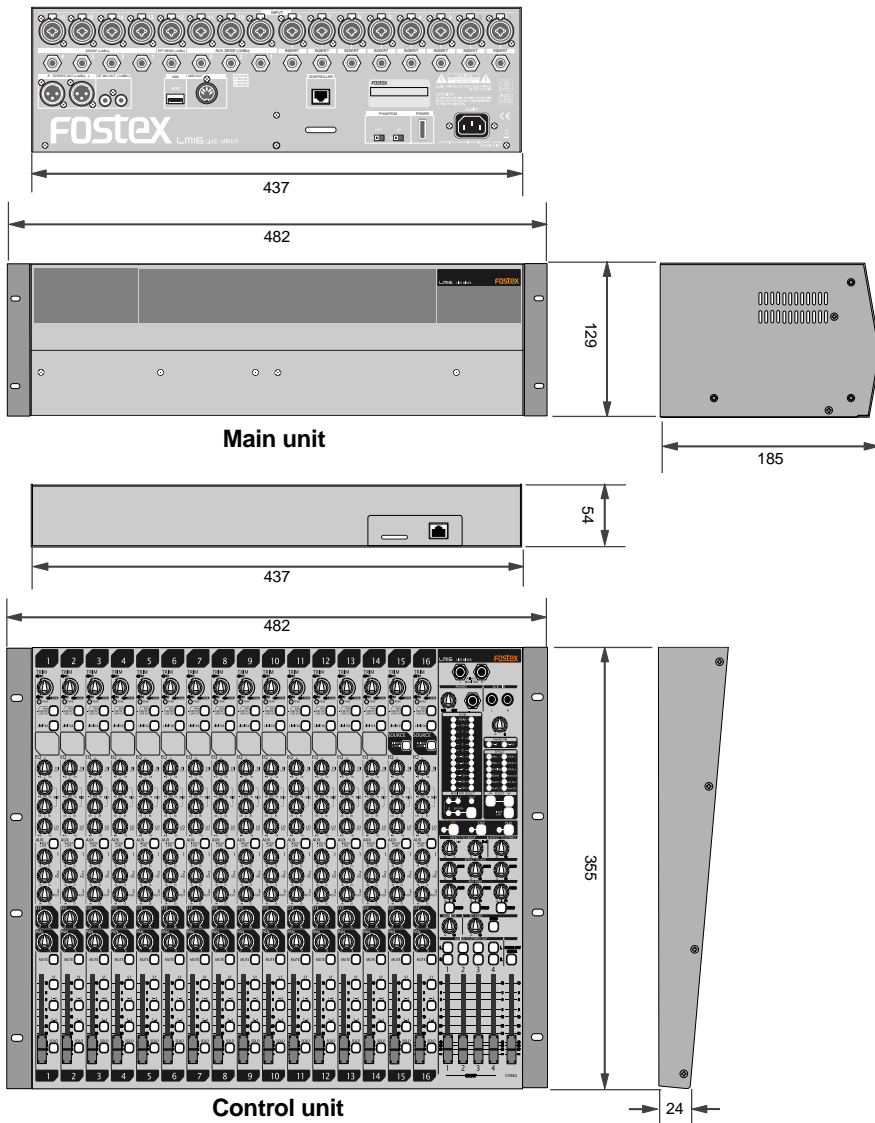

MMC Command List

<Note>: The LM16 only supports the MMC commands with (*) in the list below.

Command List	Movement (Recorder)
01 : STOP	STOP (*)
02 : PLAY	PLAY (*)
06 : RECORD STROBE	REC (*)

[LIVE MIXER]

Model LM16

Date: 2009.3.14

Version: V1.00

MIDI Implementation Chart

Function.....		Transmitted	Recognized	Remarks
Basic Channel	Default	X	X	
	Changed	X	X	
Mode	Default	X	X	
	Message	X	X	
	Altered	*****	X	
Note Number:	True Voice	X	X	
		*****	X	
Velocity	Note ON	X	X	
	Note OFF	X	X	
After Touch	Key's	X	X	
	Channel's	X	X	
Pitch Bend		X	X	
Control Change		X	X	
Program Change	True #	X	X	
		*****	*****	
System Exclusive		X	X	
Common	: Quarter Frame	O	X	
	: Song Position	X	X	
	: Song Select	X	X	
	: Tune	X	X	
System Real Time	: Clock	X	X	
	: Commands	X	X	
Aux. Message	: Local ON/OFF	X	X	
	: All Notes OFF	X	X	
	: Active Sense	X	X	
	: Reset	X	X	
Notes				

Mode 1: OMNI ON, POLY
 Mode 3: OMNI OFF, POLY

Mode 2: OMNI ON, MONO
 Mode 4: OMNI OFF, MONO

O: Yes
 X: No

Declaration of EC Directive

This equipment is compatible with the EMC Directive (2004/108/EC) - Directive on approximation of member nation's ordinance concerning the electromagnetic compatibility and with the Low Voltage Directive (73/23/EEC) - Directive on approximation of member nation's ordinance concerning electric equipment designed to be used within the specified voltage range.

The Affect of Immunity on This Equipment

The affect of the European Specification EN61000-6-1 (coexistence of electromagnetic waves - common immunity specification) on this equipment are as shown below.

In the electrical fast transient/burst requirements, surge, conducted disturbances by radio-frequency fields, power frequency magnetic field, radiate electromagnetic field requirements and static electricity discharging environment, this could be affected by generation of noise in some cases.

FOSTEX DISTRIBUTORS LIST IN EUROPE

* Including non-EU countries (as of March 2007)

<AUSTRIA>

NAME: ATEC Audio-u. Videogeraete VertriebsgesmbH.
 ADD: Im Winkel 5, A-2325 Velm, Austria
 TEL: (+43) 2234-74004, FAX: (+43) 2234-74074

<BELGIUM>

NAME: General Audio
 ADD: Raymond Pelgrimslaan 101, B-1702 Groot-Bijgaarden, Belgium
 TEL: (+32) 2-4630650, FAX: (+32) 2-4661500

<DENMARK>

NAME: SC Sound ApS
 ADD: Malervej 2, DK-2630 Taastrup, Denmark
 TEL: (+45) 4399-8877, FAX: (+45) 4399-8077

<FINLAND>

NAME: Norettron Oy Audio
 ADD: P. O. Box 22, FIN-02631 Espoo, Finland
 TEL: (+358) 9-5259330, FAX: (+358) 9-52593352

<FRANCE>

NAME: Sennheiser France
 ADD: 128 bis, avenue Jean-Jaures, 94851 Ivry-sur-Seine Cedex, France
 TEL: (+33) 1 4987 0300, FAX: (+33) 1 4987 0324

<GERMANY>

NAME: Mega Audio GmbH
 ADD: Stromberger Str. 32, D-55411 Bingen, Germany
 TEL: (+49) 6721-94330, FAX: (+49) 6721-32046

<GREECE>

NAME: Bon Studio S. A.
 ADD: 6 Zaimi Street, Exarchia, 106.83 Athens, Greece
 TEL: (+30) 210-3809-605, 606, 607, 608
 FAX: (+30) 210-3845-755, 210-3827-868

<ICELAND>

NAME: I. D. elrf. electronic Ltd.
 ADD: ARMULA 38 108 REYKJAVIK, ICELAND
 TEL: (+354) 588 5010, FAX: (+354) 588 5011

<ITALY>

NAME: Proel S. p. A.
 ADD: Zona Via Alla Ruenia, 37/43 64027 - Sant'Omero (Teramo), Italy
 TEL: (+39) 0861-81241, FAX: (+39) 0861-887862

<THE NETHERLANDS>

NAME: IEMKE ROOS AUDIO B. V.
 ADD: Kuiperbergweg 20, 1101 AG Amsterdam, The Netherlands
 TEL: (+31) 20-697-2121, FAX: (+31) 20-697-4201

<NORWAY>

NAME: Siv. Ing. Benum AS
 ADD: P. O. Box 145, Vinderen, 0319 Oslo, Norway
 TEL: (+47) 2213 9900, FAX: (+47) 2214 8259

<SPAIN>

NAME: Letusa S. A.
 ADD: C/Laguna 10, 28923 Alcorcon, Madrid, Spain
 TEL: (+34) 91-4862800, 91-4470898
 FAX: (+34) 91-6414597

<SWEDEN>

NAME: Kinovox-Benum A/B
 ADD: Solna Strandvag 78 171 54 Solna, Sweden
 TEL: (+46) 8 5052 1176, FAX: (+46) 8 5052 1010

<SWITZERLAND>

NAME: Audio Bauer Pro AG
 ADD: Bernerstrasse-Nord 182, CH-8064 Zurich, Switzerland
 TEL: (+41) 1-4323230, FAX: (+41) 1-4326558

<UK>

NAME: SCV London
 ADD: 40 Chigwell Lane, Oakwood Hill Industrial Estate, Loughton, Essex IG10 3NY U. K.
 TEL: (+44) 20-8418-0778, FAX: (+44) 20-8418-0624

FOR THE US CUSTOMERS ONLY

FOSTEX AMERICA LIMITED WARRANTY

The following statement defines specific legal rights. You may also have additional rights depending on the state in which the Fostex product was purchased.

WARRANTY PROTECTION

All Fostex parts are warranted for one (1) year from the date of original purchase, except for recording media, such as hard disc drives and compact flash cards, heads, lamps and fuses, which are warranted, for one hundred-eighty (180) days. Fostex America will repair and / or replace parts during the term of this warranty. Labor costs are also covered by Fostex America for one (1) year from the date of original purchase. Except as specified below, this warranty covers all defects in material and workmanship in this product.

The following are not covered by this warranty:

1. Batteries.
2. Damage to any product that has been altered.
3. Damage to any product on which the original serial number has been defaced, modified or removed.
4. Damage to or deterioration of the external cabinet.
5. Damage occurring during shipment of the product. (**NOTE:** Shipping claims must be presented to the carrier.)
6. Damage resulting from accident, misuse, abuse or neglect.
7. Damage resulting from failure to perform routine maintenance and / or calibration procedures.
8. Damage resulting from failure to follow instruction in the owner's manual.
9. Damage resulting from repair or attempted repair or by someone other than a Fostex America Service technician or a technician at an authorized Fostex America service station.
10. Damage resulting from causes other than product defects, including lack of technical skill, competence or experience on the part of the user.
11. External appearance items such as cosmetic parts, knobs, liquid crystal displays, buttons, etc.
12. Replacements or repairs necessitated by loss or damages resulting from any cause beyond the control of Fostex America.
13. Damage resulting from misuse or abuse on rental units.

NOTE: FOSTEX AMERICA IS NOT RESPONSIBLE FOR DATA LOST OR DAMAGED DURING OPERATION OF THIS PRODUCT. CALIBRATION AND MAINTENANCE PROCEDURES ARE NOT COVERED BY THIS WARRANTY.

Fostex America reserves the right to inspect all products submitted pursuant to this warranty. If such an inspection shows reasonable cause to believe that any of the above exclusions to the above warranty are applicable, then Fostex America or the authorized service station will charge prevailing service rates and parts, costs for any repairs.

FOSTEX AMERICA LIMITED WARRANTY

To claim all warranty service, first access www.fostex.com to receive service authorization (RMA number). Then present the authorization together with the bill of sale, which shows the date of original purchase to Fostex America. This warranty is not transferable.

SHIPPING

If this product needs service, you must take it, or package it carefully, using ample packaging materials to prevent damage during shipment and mail it to the distributor from whom you have purchased this product, postage pre-paid and insured.

NOTE: Fostex America will not assume responsibility for damages or losses occurred in transit, but will reasonably assist the sender in processing any claims whenever possible (such as submitting statements to the carriers when applicable).

Any collect or C.O.D. shipments will be refused. In order to obtain warranty repairs, you must include the following:

1. Date proof of original purchase (copy of bill of sale or charge slip).
2. A note describing the problem with sufficient particularity to allow Fostex America to inspect or adjust the problem.
3. All accessory items appurtenant to that problem.

LIMITATIONS OF IMPLIED WARRANTIES AND EXCLUSIONS OF CERTAIN DAMAGES

Unless considered unenforceable or unlawful under applicable law:

- A. All implied warranties - including warranties of merchantability and fitness for a particular purpose - are limited in duration to term of this warranty and to the express coverage of this warranty;
- B. Fostex America's liability for any defect product is expressly limited to repair or replacement of the product, at the sole discretion and / or option of Fostex America. Fostex America shall not under any circumstances be liable for:
 1. Damaged based on inconvenience, loss of use of the product, loss of time, interrupted operation or commercial loss, OR;
 2. Any damages, whether incidental, consequential or otherwise, except damages which may not be excluded by under applicable law.
- C. Fostex America makes no other warranties, express or implied, above and / or beyond the representations made herein.

WARRANTY APPLIES ONLY TO THOSE PRODUCTS SOLD AND DISTRIBUTED BY FOSTEX AMERICA

Service Department

FOSTEX AMERICA

9 Mars Court Boonton, NJ 07005

TEL: 973-394-0015 FAX: 973-394-0800

Email: support@fostexusa.com

Web: www.fostex.com

Index

<A>		Post-fader	30
Adjusting the input level	28	Power supply	7, 15
		Pre-fader	30
Balanced type	18	<R>	
Bus	27	Rack mount adaptor	13
Block diagram	35	<S>	
<C>		Selecting channel source	28
Cable guide	13	Signal flow of the mixer	27
CAT-5 cable	11	Solo monitoring	33
Channel grouping	33	Specifications	38
Condensation	8	Stereo bus	27
Connector	18	SUB IN	34
Control unit	11, 19	<T>	
Connection		Trim control	20, 28
Connecting the power cord	15	<U>	
Connection to external devices	16	Unbalanced type	18
<E>		Upgrade	37
Equalizer	20, 29	USB	37
Effect processor		Using insert	31
External effect processor	30	Using AUX 1, 2 and 3	30
Internal effect processor	31	Using SUB IN	34
Effect type	32	<V>	
<G>		Version	36
Grouping	33	<W>	
<H>		Website	37
Home recording	17	<Y>	
<I>		Y cable	25, 31
Input channel	20		
Input connector	28		
Input level	28		
INSERT	25, 31		
Internal effect processor	31		
<L>			
Limiter	29		
Live stage	16		
Low cut	29		
<M>			
Main unit	15, 27		
Master channel	22		
MIDI Implementation Chart	41		
Mixer functions	27		
MMC Command List	40		
Monitoring	32		
<N>			
Names and functions	19		
<P>			
Phantom power	28		
Physical dimensions	39		

Memo

Fostex[®]

FOSTEX CO.

3-2-35 Musashino, Akishima-shi, Tokyo Japan 196-0021