

## Owner's Manual

# FM-4



## PORTABLE MIXER



Thank you very much for purchasing the Fostex FM-4 portable mixer. To ensure the best performance, read this manual thoroughly before using the unit. Keep this manual handy for future reference.

### Table of contents

<b>Safety Instructions</b> .....	<b>2</b>	<b>Display</b> .....	<b>17</b>
<b>Precautions</b> .....	<b>4</b>	Adjusting the display brightness .....	17
Precautions before using .....	4	Selecting the meter mode .....	18
Precautions on installation .....	4	Selecting the status display .....	18
<b>Main features</b> .....	<b>5</b>	Input status display .....	19
<b>Basic operations</b> .....	<b>6</b>	T12 power supply mode setting .....	19
Preparation of power supply .....	6	Output status display .....	20
Preparation of input channels .....	7	Status information details .....	21
Preparation of output channels .....	7	Limiter parameter setting .....	21
Preparation of metering .....	7	Meter status display .....	22
Preparation of monitoring .....	8	Parameter setting procedure .....	22
Master fader reference setting .....	8	Parameter details .....	23
Master fader reference setting .....	9	Peak meter on/off .....	23
Audio setting .....	9	VU meter reference level .....	23
<b>Block diagram</b> .....	<b>10</b>	Lighting level of peak over indicator .....	23
<b>Names and functions</b> .....	<b>11</b>	Internal battery selection .....	23
Front panel .....	11	System status display .....	24
Left side panel .....	14	Initializing the flash memory .....	24
Right side panel .....	15	<b>Specifications</b> .....	<b>25</b>
		<b>External dimensions</b> .....	<b>27</b>

	<b>CAUTION</b> RISK OF ELECTRIC SHOCK DO NOT OPEN	
CAUTION: TO REDUCE THE RISK OF ELECTRIC SHOCK, DO NOT REMOVE COVER (OR BACK). NO USER - SERVICEABLE PARTS INSIDE. REFER SERVICING TO QUALIFIED SERVICE PERSONNEL.		

## "WARNING"

"TO REDUCE THE RISK OF FIRE OR ELECTRIC SHOCK, DO NOT EXPOSE THIS APPLIANCE TO RAIN OR MOISTURE."

## SAFETY INSTRUCTIONS

1. Read Instructions - All the safety and operating instructions should be read before the appliance is operated.
2. Retain Instructions - The safety and operating instructions should be retained for future reference.
3. Heed Warnings - All warnings on the appliance and in the operating instructions should be adhered to.
4. Follow Instructions - All operating and use instructions should be followed.
5. Water and Moisture - The appliance should not be used near water - for example, near a bathtub, washbowl, kitchen sink, laundry tub, in a wet basement, or near a swimming pool, and the like.
6. Carts and Stands - The appliance should be used only with a cart or stand that is recommended by the manufacturer.



An appliance and cart combination should be moved with care. Quick stops, excessive force, and uneven surfaces may cause the appliance and cart combination to overturn.

7. Wall or Ceiling Mounting - The appliance should be mounted to a wall or ceiling only as recommended by the manufacturer.
8. Ventilation - The appliance should be situated so that its location or position does not interfere with its proper ventilation.  
For example, the appliance should not be situated on a bed, sofa, rug, or similar surface that may block the ventilation openings; or, placed in a built-in installation, such as a bookcase or cabinet that may impede the flow of air through the ventilation openings.
9. Heat - The appliance should be situated away from heat sources such as radiators, heat registers, stoves, or other appliances (including amplifiers) that produce heat.
10. Power Sources - The appliance should be connected to a power supply only of the type described in the operating instructions or as marked on the appliance.
11. Grounding or Polarization - The precautions that should be taken so that the grounding or polarization means of an appliance is not defeated.
12. Power Cord Protection - Power supply cords should be routed so that they are not likely to be walked on or pinched by items placed upon or against them, paying particular attention to cords at plugs, convenience receptacles, and the point where they exit from the appliance.

**CAUTION:**  
TO PREVENT ELECTRIC SHOCK, MATCH WIDE BLADE OF PLUG TO WIDE SLOT, FULLY INSERT.

**ATTENTION:**  
POUR EVITER LES CHOCS ELECTRIQUES, INTRODUIRE LA LAME LA PLUS LARGE DE LA FICHE DANS LA BORNE CORRESPONDANTE DE LA PRISE ET POUSSER JUSQU' AU FOND.



The lightning flash with arrowhead symbol, within an equilateral triangle, is intended to alert the user to the presence of uninsulated "dangerous voltage" within the product's enclosure that may be of sufficient magnitude to constitute a risk of electric shock to persons.



The exclamation point within an equilateral triangle is intended to alert the user to the presence of important operating and maintenance (servicing) instructions in the literature accompanying the appliance.

13. Cleaning - The appliance should be cleaned only as recommended by the manufacturer.
14. Nonuse Periods - The power cord of the appliance should be unplugged from the outlet when left unused for a long period of time.
15. Object and Liquid Entry - Care should be taken so that objects do not fall and liquids are not spilled into the enclosure through openings.
16. Damage Requiring Service - The appliance should be serviced by qualified service personnel when:
  - A. The power supply cord or the plug has been damaged; or
  - B. Objects have fallen, or liquid has been spilled into the appliance; or
  - C. The appliance has been exposed to rain; or
  - D. The appliance does not appear to operate normally or exhibits a marked change in performance; or
  - E. The appliance has been dropped, or the enclosure damaged.
17. Servicing - The user should not attempt to service the appliance beyond that described in the operating instructions. All other servicing should be referred to qualified service personnel.
18. The appliance should be situated away from drops of water or spray of water.
19. Objects containing liquid such as vase must not be put on the appliance.
20. The appliance is not completely isolated from the power supply even if the power switch is at off position.
21. Apparatus shall not be exposed to dripping or splashing and no objects filled with liquids, such as vases, shall be placed on the apparatus.
22. Only use attachments/accessories specified by the manufacturer.
23. An appliance with a protective earth terminal should be connected to a mains outlet with a protective earth connection.
24. An appliance should be placed in a position where an AC plug / inlet can be easily pulled out by hand.
25. Main plug is used as the disconnection device. It shall remain readily operable and should not be obstructed during intended use. To be completely disconnected the apparatus from supply mains, the mains plug of the apparatus shall be disconnected from the mains socket outlet completely.

## Important Safety Instructions

- 1) Read these instructions.
- 2) Keep these instructions.
- 3) Heed all warnings.
- 4) Follow all instructions.
- 5) Do not use this apparatus near water.
- 6) Clean only with dry cloth.
- 7) Do not block any ventilation openings. Install in accordance with the manufacturer's instructions.
- 8) Do not install near any heat sources such as radiators, heat registers, stoves, or other apparatus (including amplifiers) that produce heat.
- 9) Do not defeat the safety purpose of the polarized or grounding-type plug. A polarized plug has two blades with one wider than the other. A grounding type plug has two blades and a third grounding prong. The wide blade or the third prong are provided for your safety. If the provided plug does not fit into your outlet, consult an electrician for replacement of the obsolete outlet.
- 10) Protect the power cord from being walked on or pinched particularly at plugs, convenience receptacles, and the point where they exit from the apparatus.
- 11) Only use attachments/accessories specified by the manufacturer.
- 12) Use only with the cart, stand, tripod, bracket, or table specified by the manufacturer, or sold with the apparatus. When a cart is used, use caution when moving the cart / apparatus combination to avoid injury from tip-over.  

- 13) Unplug this apparatus during lightning storms or when unused for long periods of time.
- 14) Refer all servicing to qualified service personnel. Servicing is required when the apparatus has been damaged in any way, such as power-supply cord or plug is damaged, liquid has been spilled or objects have fallen into the apparatus, the apparatus has been exposed to rain or moisture, does not operate normally, or has been dropped.
- 15) Excessive sound pressure from earphones and headphones can cause hearing loss.

# Precautions

## Precautions before using

- Do not supply the voltage that does not match the voltage requirement of the unit.
- If you operate the unit on battery power, use alkaline or nickel hydride batteries.
- If you supply the power to the unit from the AC power outlet, only use the optional dedicated Fostex AC adaptor.  
If you use any other AC adaptor, the unit may not work correctly and there is a serious risk of damage to the unit.
- If you wish to use the unit in a country where the voltage of the AC power outlet does not match your AC adaptor, ask your local Fostex dealer or service station for purchasing an appropriate AC adaptor. Note that the AC adaptor can be used both in 50 Hz and 60 Hz areas.
- Do not let water or other liquid, or metal objects such as pins, accidentally enter the inside of the unit.  
Should water enter the inside of the unit, turn off the power, unplug the AC adaptor and remove batteries, and consult your dealer or the nearest FOSTEX service station.
- Do not drop the unit or give it a strong shock. The internal circuits, display or panels may be damaged.
- To prevent possible electric shock and damage to the unit, do not remove the cover or reach the inside of the unit.

## Precautions on installation

### Do not install the unit in the following conditions.

- \* In an extremely hot or cold place
- \* In a moist place
- \* In a strong magnetic field or near a device which generates a magnetic field
- \* In the direct rain or water

**<Note>**: The unit is designed for outdoor use, however, it is not waterproof. Do not use the unit in the direct water.

### Notes on moisture condensation

When you bring the unit from a cold place to a warm place, moisture may condense on the display, panels, etc. In such a case, turn off the power and leave the unit for a while until it warms up and evaporates any moisture.

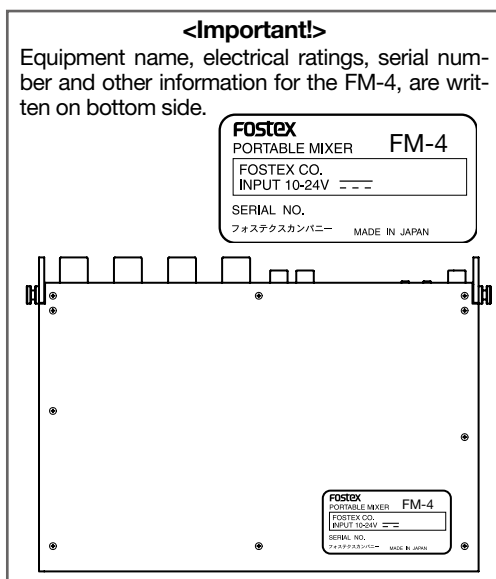

## Main features

### Mixer section features

- Four input channels and two output channels. These are transformer-balanced.
- The analog VCA limiter is provided on each of left and right stereo output channels. You can select the desired threshold level and compression ratio using the output status display.
- In addition to the [MAIN OUT] (L/1, R/2) outputs, [SUB OUT] (L/3, R/4), [TAPE OUT] and [AUX OUT] (1, 2) outputs are also provided, allowing comprehensive connection to external audio equipment.
- You can monitor signals from the [AUX IN] input, as well as you can mix them with the main input signals. By connecting the [AUX OUT] output to the [AUX IN] input of another FM-4 (or FM-3), you can cascade two FM mixers.
- You can connect a microphone or line-level source to each of the [INPUT] 1 through 4 inputs. The unit can provide P48 or T12 power to a condenser microphone connected to each input.
- Each input signal can be positioned anywhere in the stereo field using the pan pot provided on each input channel.
- Two 2-band EQ channels are provided. You can equalize up to two input signals.
- Both 1/4-inch phone and stereo mini jacks are provided for headphone monitoring. You can use two stereo headphones simultaneously.
- The monitor select switch allows you to select the signal for headphone monitoring. In addition, the [PFL (Pre Fader Listen)] switch allows you to directly monitor each of [INPUT] 1 through 4 signals.
- The output level of the [MAIN OUT] (L/1, R/2) and [SUB OUT] (L/3, R/4) connectors can be independently selected from +4 dBu, 0 dBu, -10 dBu and -60 dBu.

### Display and control features

- The 128 x 64 dot-matrix display using organic LED devices shows the VU (needle) and peak (bar-graph) meters simultaneously.
- You can select the meter display mode from stereo, mono left and mono right.

- AR (anti-reflection) coating is applied to the protection plate for the display to reduce reflection.
- Each input channels provides the trim control and two-color peak indicator for optimum level adjustment.
- Frequently used controls such as the input trim controls, channel faders, monitor-related switches, etc., are placed on the front panel for central control.
- Pop up knobs are used for the input trim, panpot, HPF, EQ, [PHONES] and [MASTER] controls to avoid inadvertent operation.
- You can view the positions of all switches on the side panel from the input status and output status displays.

### Power supply features

- The unit can be operated on battery or AC power. You can fit the battery box with eight AA alkaline or nickel hydride batteries inside the unit or connect the optional AC adaptor (or external battery). \*Note that no battery is supplied with the unit.
- Up to five-hour continuous operation is possible using alkaline batteries. (Note that the actual continuous operation time depends on the circumstance.)
- The battery box is supplied with the unit, however, it is also available in option. For long continuous use, it is recommended to purchase the optional battery box as a spare.
- The [DC-OUT] connector is provided for supplying DC power to an external wireless receiver, etc.
- The battery indicator on the display always shows battery remaining, while the [EMPTY] indicator and alert display warn you when the battery voltage is low.

### Other features

- For lightweight and rigidity, aluminum is used for panels, etc.
- Compact size design, a great advantage for outside use.
- The shoulder belt and soft protection case are available in option. Ask your local Fostex dealer or service station for details about optional products.

# Basic operations

## Preparation of power supply

To operate the unit on internal battery power, set AA alkaline or nickel hydride batteries to the supplied battery box and fit the box to the battery compartment on the right side panel.

Battery box compartment

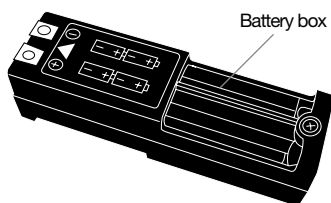
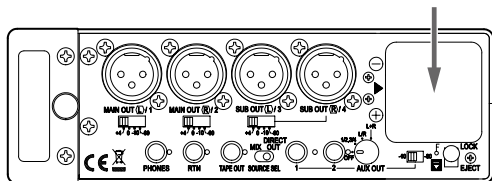

Make sure to set alkaline or nickel hydride batteries to the battery box in correct direction as marked on the box. Set four batteries on each side of the battery box.

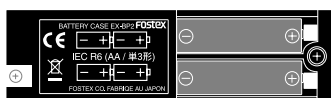

**<Note>**: Always use eight new alkaline or fully charged nickel hydride batteries of the same model and same capacity.

**<Note>**: Insert the battery box to the battery box compartment in the correct direction by matching the ▲ symbol on the battery box to the ▲ symbol on the panel of the unit.

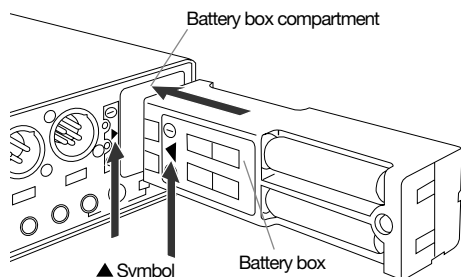

After fully inserting the battery box, slide up the [EJECT/LOCK] lever to the LOCK position. A tab appears as shown on the right figure and the battery box is locked.

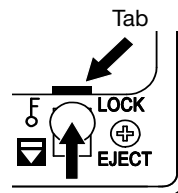

**<Memo>**: To remove the battery box, slide down the [EJECT/LOCK] lever to unlock the battery box.

The battery box is slid to the front a few millimeters and you can pull it out by hand.

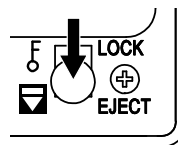

**<Note>**: Before you remove the battery box, turn off the power or set the [POWER] switch to the "EXT" position.

**<Memo>**: You can set the battery type (alkaline or nickel hydride) to be used from the meter display. By default, it is set for alkaline batteries. If you use nickel hydride batteries, change the battery type setting (see page 23).

**<Note>**: If the battery type setting do not match the batteries currently used, the EMPTY indicator, battery indicator and alert display do not work correctly.

To operate the unit on external power, connect the optional dedicated AC adaptor or an external battery to the [DC-IN] connector on the left side panel.

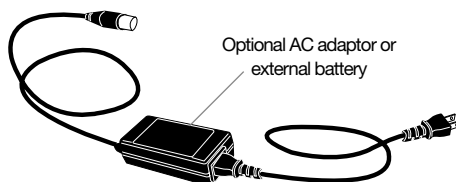
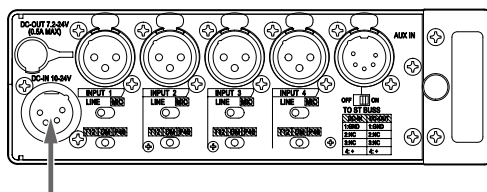

**<Note>**: The rated voltage of the [DC IN] connector is DC 10 V to 24 V. When you connect an external power source to the [DC IN] connector, use the appropriate power source that matches the rated voltage of the [DC IN] connector. For the detail information on the pin assignment of the [DC IN] connector, see page 14 of "Features and controls".

You can turn on the unit by setting the [POWER] switch on the front panel to "INT" (upper position) or "EXT" (lower position). When you operate the unit on internal battery power, set the switch to "INT".

When you operate the unit on external power, set it to "EXT". When you turn on the unit for the first time, the display shows the stereo VU meters as shown below. When you operate the unit on (internal or external) battery power, confirm that the battery power is sufficient by checking the battery indicator on the meter display.

You can check the power voltage of the battery power source from the system status display (see page 23).

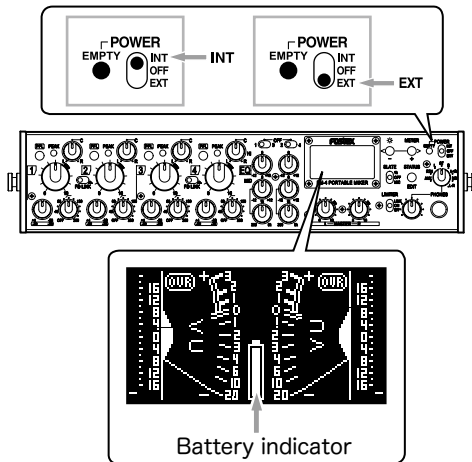

## Preparation of input channels

- (1) Connect a microphone or line level source to each of the [INPUT] connectors (1 through 4).
- (2) When you connect a microphone, set the input select switch to "MIC". When you connect a line level source, set the input select switch to "LINE".
- (3) When you connect a microphone, set the microphone power supply switch appropriately. When you connect a condenser microphone that requires +48 V phantom power, set the switch to "P48". When you connect a condenser microphone that requires T-12 power (A-B 12 V) such as Sennheiser 416T, set the switch to "P48". When you connect a dynamic microphone, set the switch to "DM".

**<Memo>**: If you do not need T12 (A-B 12 V) power supply capability, you can disable this capability from the input status display. By default, it is enabled. See page 19 for details.

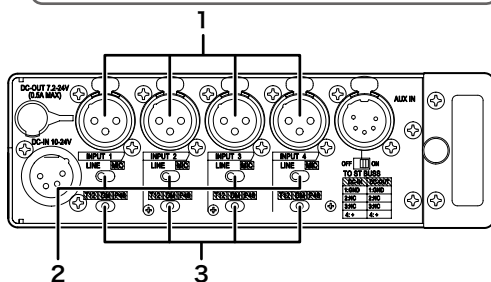

## Preparation of output channels

- To send the stereo output signals to an external audio device

You can send the stereo mixed signals to an external audio device from the [MAIN OUT] (L/1, R/2) connectors.

- (1) Set the [SOURCE SEL] switch to "MIX".

**<Memo>**: The [SUB OUT] (L/3, R/4) connectors also send the same signals as the [MAIN OUT] (L/1, R/2) connectors.

- (2) Connect an external audio device such as a recorder to the [MAIN OUT] (L/1, R/2) connectors.
- (3) Set the output level switch appropriately depending on the device connected. You can set the nominal output level to +4 dBu, 0 dBu, -10 dBu or -60 dBu.
- (4) To connect a -10 dBV unbalanced line level device, use the [TAPE OUT] jack (stereo mini jack). The nominal output level of this jack is fixed to -10 dBV.

**<Memo>**: The stereo buss signal is output from the [TAPE OUT] jack.

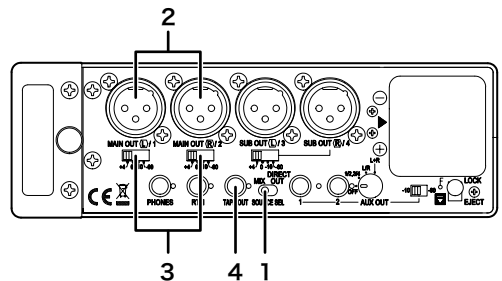

- To output each input signal directly

You can send "post-fader" input signals of the INPUT 1 through 4 from the [MAIN OUT] (L/1, R/2) and [SUB OUT] (L/3, R/4) connectors respectively.

- (1) Set the [SOURCE SEL] switch to "DIRECT OUT".
- (2) Connect the external device(s) to the [MAIN OUT] and/or [SUB OUT] connectors.
- (3) Set the output level switch appropriately to match the external device. You can set the nominal output level to +4 dBu, 0 dBu, -10 dBu or -60 dBu.

## Preparation of metering

- Select stereo or mono metering.**  
When the unit is shipped, the display is set to stereo VU and peak metering. You can change it to L or R channel mono metering (see page 18 for details).

**<Memo>**: Using the meter status display, you can disable or enable the peak meter function, select the VU meter reference level, and select the "OVR" indicator lighting level (see page 22 for details).

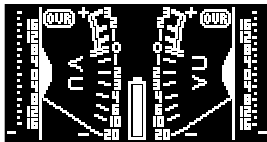

Stereo metering

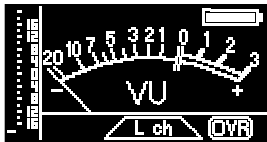

Mono metering (L)

- Adjust the display brightness if required.**  
When the unit is shipped, the display brightness is set to "Level 3". You can change it to the optimum brightness according to the circumstance. See page 17 for details.

## Preparation of monitoring

- Connect headphones to the 1/4-inch [PHONES] jack on the front panel or the mini-phone [PHONES] jack on the right side panel.**  
You can use both the 1/4-inch and mini-phone jacks simultaneously.
- Set the monitor select switch to "ST" and adjust the monitor level using the [PHONE] control.**

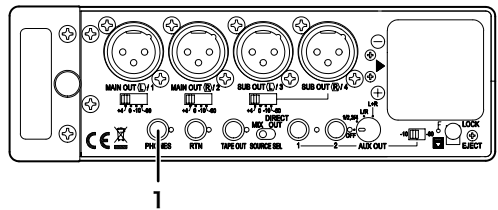
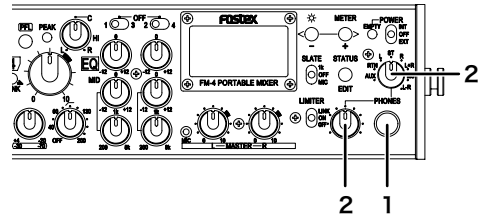



## Master fader reference setting

- (1) Turn down the rotary faders on input channels 1 through 4.
- (2) Set the [SLATE] switch on the front panel to “1k” (upper position).
- (3) Set the [MASTER] L and R faders to the two-o’clock position (marked in orange) so that the meter needles point to 0 VU (see the figure below).  
Normally this is the reference output position.

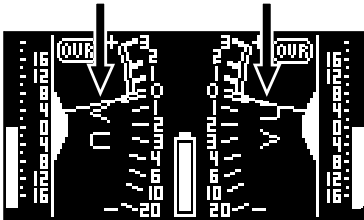
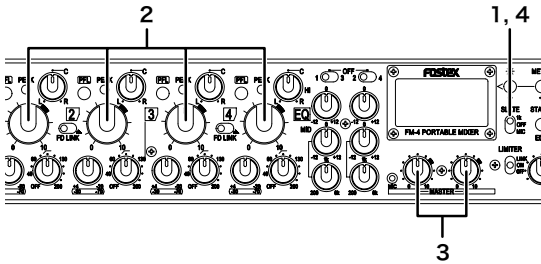

<Memo>: In the following figures, the meter needles point the reference (0 VU).

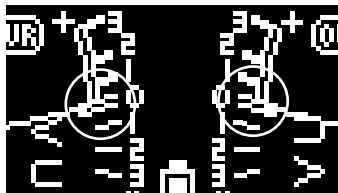

Stereo metering



Mono metering

- (4) After adjusting the reference level, switch the [SLATE] switch to “OFF”.

## Audio setting

- (1) Set the [MASTER] faders to the reference position.
- (2) Receive input signals and adjust the trim control of each channel.  
Adjust the trim control appropriately so that the peak indicator does not light in red at the maximum sound level.
- (3) Raise up the channel fader of each channel gradually until the meter shows the proper level.
- (4) Set the pan and HPF controls of each input channel appropriately if required.

<Memo>: The HPF cuts the unnecessary low frequency range, such as wind blowing.

- (5) If you want to apply the EQ to input channels, set the EQ switches and controls appropriately.  
To use the EQ, select the input channels you apply the EQ to using the EQ switches and make EQ setting using the EQ controls. If you do not apply the EQ to an input channel, set the EQ switch to OFF.
- (6) If you want to apply the limiter to the main output, set the [LIMITER] switch to “ON” (or “LINK”).

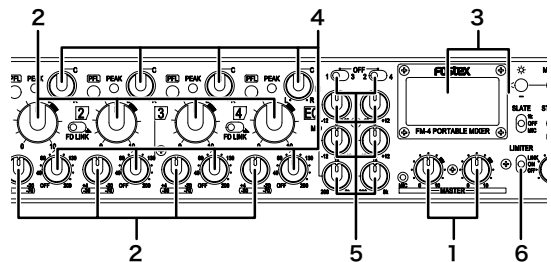

# Block diagram

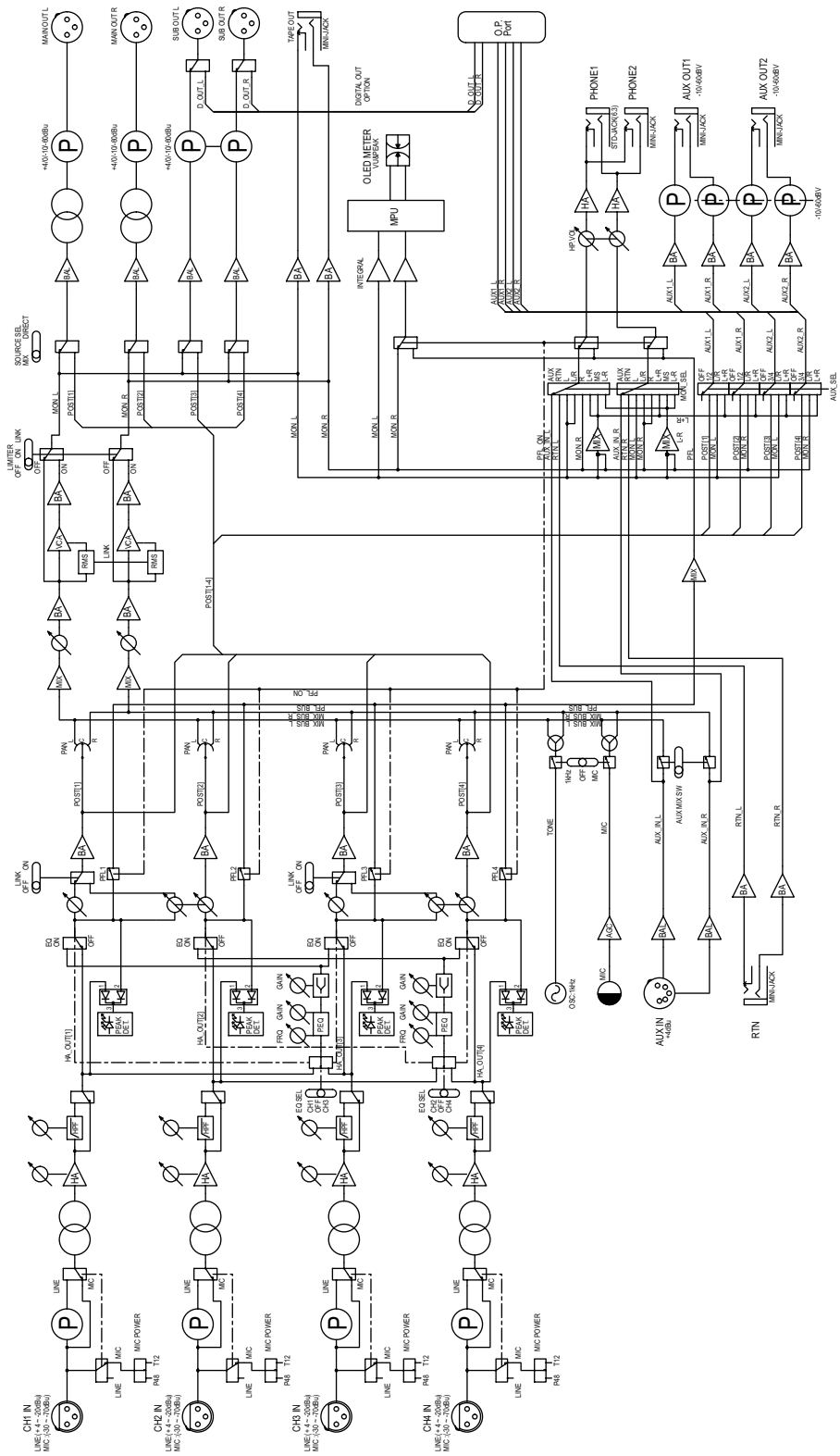

# Names and functions

## Front panel

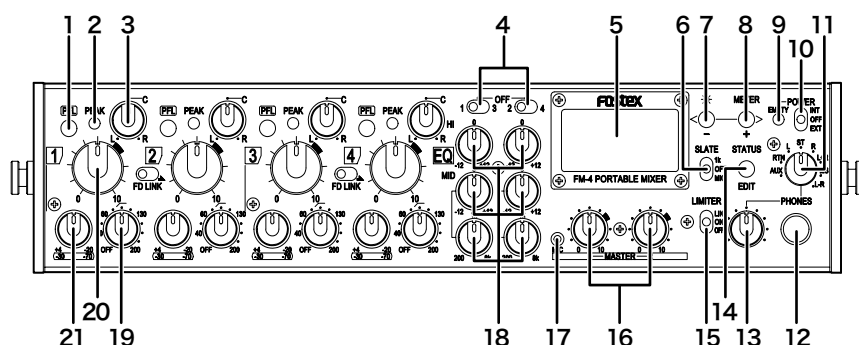

- 1. [PFL] (Pre Fader Listen) keys (1 through 4)**  
While pressing down the key, the pre-fader signal (before the input channel fader) is output from the [PHONES] jacks. In this condition, the display shows the PFL signal level metering as below.

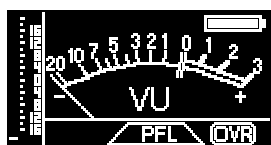

- 2. PEAK indicators (1 through 4)**  
Each indicator lights according to the signal level of the corresponding input channel as follows.

Color	Lighting level (compared with the reference level)	Details
Green	+8dB	Approximately -12dB below the internal maximum level
Red	+17dB	Approximately -3dB below the internal maximum level

- 3. Pan controls (1 through 4)**  
Each pan control determines the position of the corresponding input signal in the stereo image. A pop-up type knob is used for each pan control. A pop-up type knob is used for each pan control. It pops up when you push it once. Pushing it again makes it locked on the same level as the panel.

- 4. EQ switches (1-3, 2-4)**  
The unit features a couple of EQ channels. Each EQ switch selects the input channel to which the corresponding EQ is to be applied.
- 1-3 switch: By setting it to the left position, you can apply EQ to input channel 1. By setting it to the right position, you can apply EQ to input channel 3. By setting it to the center position, this EQ channel is disabled.
  - 2-4 switch: By setting it to the left position, you can apply EQ to input channel 2. By setting it to the right position, you can apply EQ to input channel 4. By setting it to the center position, this EQ channel is disabled.

- 5. Display**  
The 128 x 64 dot-matrix display using organic LED devices shows the VU (needle) and peak (bar-graph) meters, battery status, etc. When you first turn on the unit after purchasing, the stereo VU and peak meters are shown.

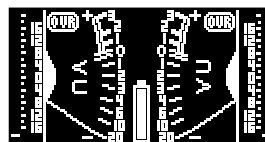

**<Memo>**: For details about the contents of the display, see "Display details" on page 17.

6. **[SLATE] switch (1k / OFF / MIC)**  
 When it is set to “1k”, a 1-kHz slate tone is generated and sent to the stereo L and R busses. While you hold it down to “MIC”, the internal slate microphone signal is sent to the stereo L and R busses.

7. **[☀] / [-] key**  
 Holding down this key for a second or more enters the brightness adjustment mode.  
 In the brightness adjustment mode, meter selection mode or status display mode, this key acts as the [-] key (see page 17).

8. **[METER] / [+] key**  
 Holding down this key for a second or more enters the meter selection mode. In the brightness adjustment mode, meter selection mode or status display mode, this key acts as the [+] key (see page 18).

9. **EMPTY indicator**  
 This indicator flashes when the battery voltage falls below the threshold while you operate the unit on battery power (see page 23).  
 In normal condition, this indicator is unlit.

10. **[POWER] switch (INT / OFF / EXT)**  
 This switch turns the unit on or off.  
 When you operate the unit on external power (using the optional AC adaptor or external battery), set it to EXT.  
 When you operate the unit on internal battery power, set it to INT.

11. **Monitor select switch**  
 This switch selects the signals monitored from the [PHONE] jacks on the front and right side panels.

<b>AUX</b>	You can monitor signals received from the [AUX IN] in stereo.
<b>RTN</b>	You can monitor signals received from the [RTN] in stereo.
<b>L</b>	You can monitor the left channel signal of the stereo buss in mono.
<b>ST</b>	You can monitor the stereo buss signal in stereo.
<b>R</b>	You can monitor the right channel signal of the stereo buss in mono.
<b>L+R</b>	You can monitor the L+R signal (i.e. the L component of MS matrix) in mono.
<b>MS</b>	You can monitor the MS decoded signals (i.e. L+R from the left, L-R from the right).
<b>L-R</b>	You can monitor the L-R signal (i.e. the R component of MS matrix) in mono.

12. **[PHONES] jack**  
 You can connect stereo headphones with the 1/4-inch plug for monitoring.

Connector: 1/4” stereo phone jack

13. **Headphones level control**  
 This control is used to adjust the output level of both the 1/4-inch and mini [PHONES] jacks.

14. **[STATUS] / [EDIT] key**  
 Holding down this key for a second or more enters the status mode. In this mode, you can switch among status display pages as well as you can edit parameters (see page 18).  
 In the status display mode, this key acts as the [EDIT] key (see page 18). Pressing this key briefly exits the current mode while pressing the key for a second or more enters or exits the parameter editing mode.  
 In the brightness adjustment mode or meter selection mode, this key acts as the enter key.

15. **[LIMITER] switch (ON, OFF, LINK)**  
 This switch enables or disables the limiter function. The limiter can work individually or in link, as described below.  
 The limiter circuit is inserted after the [MASTER] fader.

<b>LINK</b>	The limiter function is enabled with the left and right channels linked. If either of left and right channel signals exceeds the threshold, both the left and right channel limiters work in the same way.
<b>ON</b>	The limiter function is enabled. Each of the left and right limiters works independently.
<b>OFF</b>	The limiter function is disabled (the limiter circuit is bypassed).

The limiter parameters are factory-preset as shown below.  
 You can change the threshold level and ratio from the output status display (see page 21).

<Factory preset values>	
• Attack time:	Approximately 5 milliseconds (fixed)
• Release time:	Approximately 200 milliseconds (fixed)
• Threshold:	+12 dB (can be changed to +9 dB or +6 dB)
• Ratio:	5:1 (can be changed to 3:1)

**<Memo>**: When you select the [LIMITER] switch to ON or LINK, the meter display shows "LIM" (pointed by arrows below). When the limiter is working, "LIM" flashes. The following shows display examples of the stereo meter display.

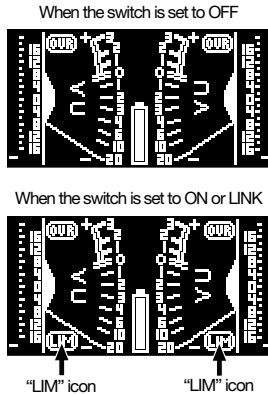

**16. [MASTER] faders (L and R)**

These faders control stereo left and right buss output levels. The scale position in orange shows the reference position. A pop-up type knob is used for each fader. It pops up when you push it once. Pushing it again makes it locked on the same level as the panel.

**17. [MIC] (Slate microphone)**

A slate microphone is built in. While holding down the [SLATE] switch to the "MIC" position, the slate microphone is active and the signal from the microphone is sent to the stereo buss.

**18. EQ controls**

These controls adjust EQ setting. The FM-4 provides two EQ channels featuring the HI and sweepable MID bands.

Band	Type	Frequency	Gain range
HI	Shelving	10 kHz	-12 dB to +12 dB
MID	Sweepable	200 Hz to 8 kHz	-12 dB to +12 dB

The three controls on the left side adjust the EQ for the input channel selected by the EQ 1-3 switch, while the three controls on the right side adjust the EQ for the input channel selected by the EQ 2-4 switch.

From the top row, these are the HI gain, MID gain and MID frequency controls.

A pop-up type knob is used for each EQ control. It pops up when you push it once. Pushing it again makes it locked on the same level as the panel.

**19. HPF controls (1 through 4)**

Each control sets the high pass filter function. At the left-most position (OFF position), the HPF circuit is bypassed. Rotating the control knob clockwise switches on the HPF (with a click). Depending on the position, you can set the HPF cut-off frequency between 40 Hz and 200 Hz (at -12 dB/oct.).

A pop-up type knob is used for each HPF control. It pops up when you push it once. Pushing it again makes it locked on the same level as the panel.

**<Memo>**: The HPF cuts the unnecessary low frequency range, such as wind blowing.

**20. Channel faders (1 through 4)**

Each fader controls the signal level sent to the stereo buss.

The scale position in orange shows the reference position.

**21. Input trim controls (1 through 4)**

Each control adjusts the input gain of the corresponding input channel. When the input select switch is set to MIC, you can adjust the gain between -70 dBu and -30 dBu.

When the input select switch is set to LINE, you can adjust the gain between -20 dBu and +4 dBu.

It is recommended to adjust the control so that the PEAK indicator does not light in red at the maximum input level.

A pop-up type knob is used for each control. It pops up when you push it once. Pushing it again makes it locked on the same level as the panel.

## Left side panel

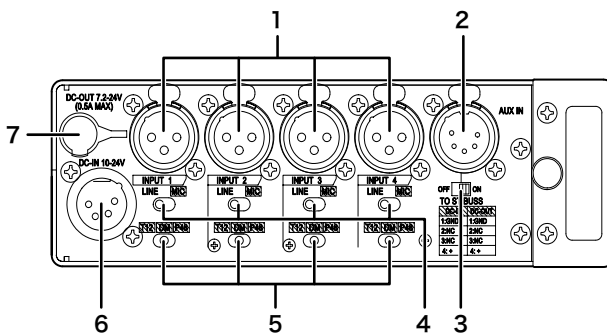

### 1. [INPUT] connector (1 through 4)

Each connector is used to connect an external audio device or microphone.  
Connector: XLR-3-31 type

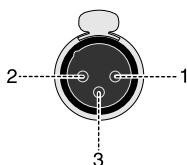

1	GND
2	HOT
3	COLD

### 2. [AUX IN] connector

Used to connect a mixer or audio device.  
Not only you can monitor the input signal of this connector, you can send the signal to the stereo buss to mix with the main input signals (selectable with the [TO ST BUSS] switch).  
Connector: XLR-5-51 type

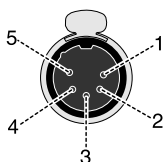

1	GND
2	Lch HOT
3	Lch COLD
4	Rch HOT
5	Rch COLD

### 3. [TO ST BUSS] switch (ON / OFF)

This switch selects whether or not the input signal from the [AUX IN] jack is sent to the stereo buss.  
To send the [AUX IN] signal to the stereo buss, set the switch to ON. When the switch is set to OFF, the [AUX IN] signal is not sent to the stereo buss.  
Regardless of the switch setting, you can monitor the [AUX IN] signal via headphones.

### 4. Input select switches (LINE / MIC)

Each switch should be set appropriately according to the input signal source of the corresponding [INPUT] connector.

<b>LINE</b>	You should set the switch to LINE when a line-level source is connected to the [INPUT] connector. When it is set to LINE, the microphone power supply is automatically turned off regardless of its setting.
<b>MIC</b>	You should set the switch to MIC when a microphone is connected to the [INPUT] connector. You can supply the microphone power when connecting a condenser microphone (see "Microphone power supply switch" below).

### 5. Microphone power supply switches (T12 / DM / P48)

Each switch sets whether or not supplying the microphone power.

<b>T12</b>	T12 or AB power supply mode. A 12 V power is supplied to the hot terminal of the [INPUT] connector.  <b>&lt;Memo&gt;</b> : If you do not need T12 power supply, you can disable the power supply via the input status display (see page 19 for details).
<b>DM</b>	No microphone power is supplied. When you connect a dynamic microphone, set the switch to DM.
<b>P48</b>	48-volt phantom power supply mode. A 48 V power is supplied to the hot and cold terminals of the [INPUT] connector.

### 6. [DC IN 10-24V] connector

Used to connect the supplied AC adaptor (or an external battery).  
Connector: XLR-4-32 type (male)

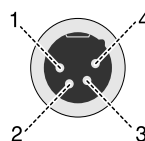

1	GND
2	NC
3	NC
4	DC 10 V to 24 V

### 7. [DC OUT 7.2-24V] connector

This connector outputs power at DC 7.2 to 24 V / 0.5 A for a wireless receiver, etc.  
It outputs power when the unit is powered on.  
Connector: Hirose 4-pin HR10A-7R-4S

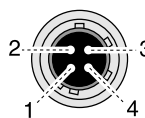

1	GND
2	NC
3	NC
4	DC 7.2 V to 24 V

Applicable plug: HR10A-7R-4P

## Right side panel

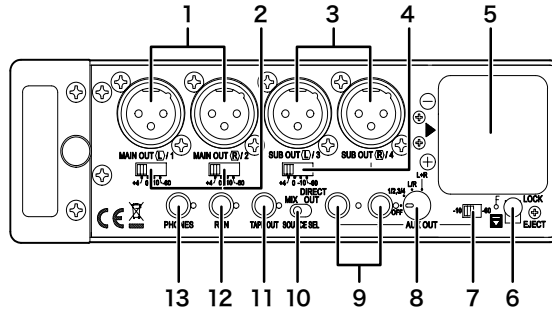

### 1. [MAIN OUT (L/1, R/2)] connectors

These connectors output the stereo buss (L, R) signals or input channel 1 and 2 signals. You can select the output signals by using the SOURCE SEL switch. You can select the reference output level using the MAIN OUT level select switches.  
Connector: XLR-3-32 type

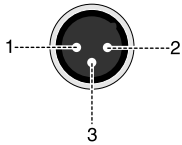

1	GND
2	HOT
3	COLD

### 2. MAIN OUT level select switches

Each switch selects the output level of the [MAIN OUT] L/1 or R/2 connector. You can select the reference level of these connectors independently from +4 dBu, 0 dBu, -10 dBu and -60 dBu.

### 3. [SUB OUT (L/3, R/4)] connectors

These connectors output the stereo buss (L, R) signals or input channel 3 and 4 signals. You can select the output signals by using the SOURCE SEL switch. You can select the reference output level using the SUB OUT level select switch.  
Connector: XLR-3-32 type

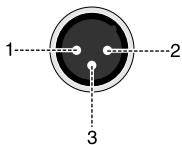

1	GND
2	HOT
3	COLD

### 4. SUB OUT level select switches

This switch selects the output level of the [SUB OUT] (L/1 and R/2) connectors. You can select the reference level of these connectors from +4 dBu, 0 dBu, -10 dBu and -60 dBu.

### 5. Battery compartment

You can set the battery box that houses eight AA alkaline or nickel hydride batteries (see page 6). When you use internal battery power, set the [POWER] switch to "INT".

### 6. [EJECT/LOCK] lever

This lever locks or unlocks the battery box. When you remove the battery box, slide down this lever to unlock the battery box (see page 6).

### 7. AUX OUT level select switch

This switch selects the output reference level of the [AUX OUT (1, 2)] jacks between -10 dBV and -60 dBV.

### 8. AUX OUT select switch

This switch selects the output signal sources of the [AUX OUT (1 and 2)] jacks.

- OFF: No signal is output from AUX 1 and 2.
- L/R: Stereo (L and R) buss signals are output from AUX 1 and 2.
- L+R: Stereo (L and R) buss signals are mixed and output from AUX 1 and 2 in mono.
- 1/2 3/4: The post-fader signals of input channels 1 and 2 are output from AUX 1, while the post-fader signals of input channels 3 and 4 are output from AUX 2.

### 9. [AUX OUT (1, 2)] jacks

These jacks output the signals selected by the AUX OUT select switch described above.  
Connector: 3.5 mm stereo mini-phone jack

**10 [SOURCE SEL] switch**

Selects the source signal of the [MAIN OUT] and [SUB OUT] connectors. You can select the master stereo signal or the post-fader signals of input channels 1 through 4.

Switch position	MAIN OUT (L/1, R/2)	SUB OUT (L/3, R/4)	Notes
MIX	Stereo buss (L, R)	Stereo buss (L, R)	The stereo buss signal is output.
DIRECT	Inputs (1, 2)	Inputs (3, 4)	The post-fader signals of the input channels are output.

**<Note>**: When you select the DIRECT position, you cannot apply the limiter to the output signals of the [MAIN OUT] connectors.

**11. [TAPE OUT] jack**

This jack outputs the unbalanced stereo buss signal. The reference level is fixed to -10 dBV.  
Connector: 3.5 mm stereo mini-phone jack

**12. [RTN] jack**

This jack accepts a -10 dBV stereo signal.  
Connector: 3.5 mm stereo mini-phone jack

**13. [PHONES] jack**

You can connect stereo headphones with the 3.5 mm plug for monitoring.  
You can monitor the same signal as the [PHONES] jack in the front panel simultaneously.  
Connector: 3.5 mm stereo mini-phone jack



# Display

The display on the front panel of the unit normally shows the VU and peak meters. You can select stereo or mono metering. The display also can show the status of inputs, outputs, etc., which you can edit. You can also adjust the display brightness to match the circumstance.

For display-related operation, the following three keys are used.

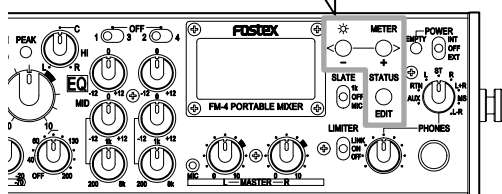
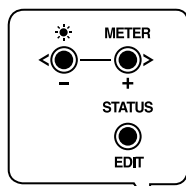

**<Memo>**: In the following description, “press the key long enough” means “hold down the key for more than one second”.

## Adjusting the display brightness

You can set the display brightness to match the circumstance (by default, it is set to level 3).

The display brightness setting remains even after you turn off the unit. If you initialize the flash memory using the system status display, it is reset to the default setting (see page 24).

- (1) Press the key long enough to enter the display brightness adjustment mode.

The brightness adjustment bar appears, showing the current brightness level.

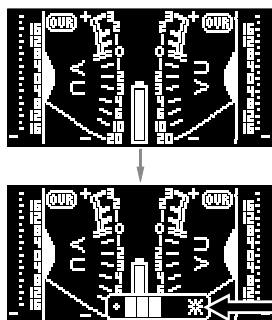

**<Memo>**: If you do not press any key for approximately five seconds while the brightness adjustment bar is shown, the bar automatically disappears and the unit exits the display brightness adjustment mode.

- (2) Press the key to lower the brightness or press the key to increase the brightness. You can select from OFF and 1 through 5.

Brightness					
Turning off the display	1	2	3	4	5

[-] key (darker)

[+] key (brighter)

**<Memo>**: If you press the [+] key when the brightness is set to OFF, the display gets brighter.

**<Note>**: If you set the brightness level to any level between 1 through 5, the setting is stored to the flash memory. However, if you set it to OFF, the setting is not stored to the flash memory, and when you turn on the unit the next time, the display is shown at the brightness level that was set before entering the brightness setting mode last time.

- (3) By pressing the [EDIT] key immediately after adjusting the brightness level, the brightness adjustment bar disappears and the unit exits the display brightness adjustment mode.

**<Memo>**: When the brightness adjustment bar is shown, pressing the [-] key long enough sets the brightness to OFF, while pressing the [+] key returns the brightness to the previous level before entering the brightness adjustment mode.

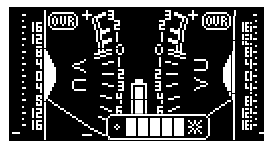

Turning off the display

When the brightness is set to any level lower than the maximum level, pressing the [+] key long enough directly sets the brightness to the maximum level.

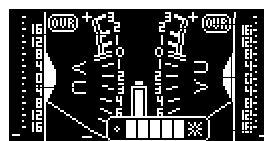
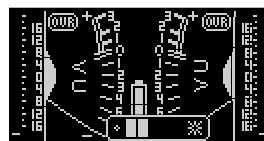

## Selecting the meter mode

You can select the meter mode from stereo, mono L and mono R. By default, it is set to the stereo mode.

The meter mode setting remains even after you turn off the unit. If you initialize the flash memory using the system status display, it is reset to the default setting (see page 24).

- (1) Press the [METER] key long enough to enter the meter select mode.

The meter mode icon is shown at the bottom of the display.

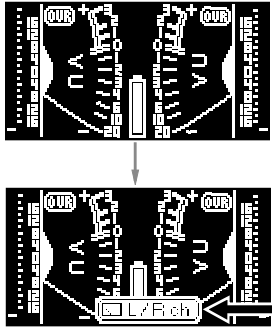

**<Memo>**: If you do not press any key for approximately five seconds while the meter mode icon is shown, the icon automatically disappears and the unit exits the meter select mode.

- (2) Press the [+] or [-] key to select the desired meter mode.

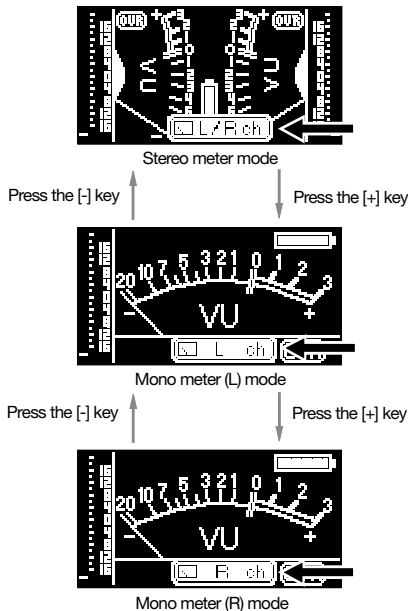

- (3) Immediately after selecting the desired meter mode, press the [EDIT] key to exit the meter select mode.

## Selecting the status display

In the status display mode, not only you can check the status for the input, output, meter and system, but also you can edit setting.

- (1) Press the [STATUS] key long enough to enter the status display mode.

The display shows the input status display.

- (2) Press the [+] or [-] key to select the desired status display.

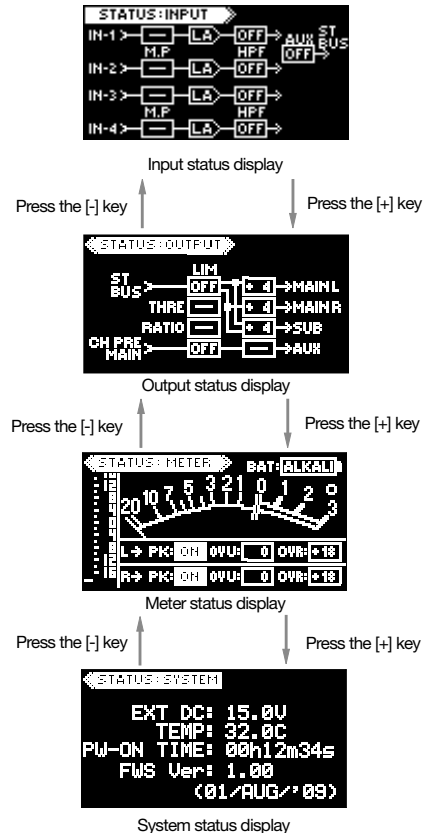

- (3) Press the [EDIT] key to exit the status display mode.

For details about the contents of each status display and parameter setting, see the next page.

## Input status display

On the input status display, not only you can see the current status of the following switches, but also you can disable or enable the T12 power supply function. The following shows the default setting when the unit is shipped.

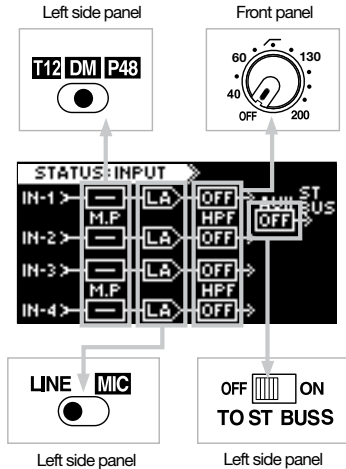

The following icons are shown according to the switch setting.

### • Microphone power supply switch status

When the input select switch (LINE / MIC) is set to "LINE", "LA" is shown. When it is set to "MIC", the microphone power supply status is shown. For the T12 status, depending on whether the T12 power supply function is enabled or disabled, the icon looks differently as below.

#### When the T12 power supply function is enabled (default)

Switch setting	T12	DM	P48
Icon	T12	OFF	P48

#### When the T12 power supply function is disabled

Switch setting	T12	DM	P48
Icon	—	OFF	P48

### • Input select switch status

Switch setting	LINE	MIC
Icon	LA	HA

### • [HPF] switch status

Switch setting	OFF	ON (40 Hz - 200 Hz)
Icon	OFF	ON

### • [TO ST BUSS] switch status

Switch setting	OFF	ON
Icon	OFF	ON

## T12 disabled/enabled setting

Some condenser microphones used for video field recording, such as the Sennheiser 416T, require T12 (AB-12V) power. The FM-4 can supply the T12 power.

Unlike the phantom power (P48), connecting a dynamic microphone to the input channel where the T12 power is supplied may destroy the microphone. To prevent such an accident, you can disable the T12 power supply function. If you do not use the T12 power supply function in your circumstance, it is recommended to disable the T12 power by following the procedure below. When shipped, the T12 power supply function is enabled.

**<Note>**: In the following description, it is assumed that the input select switches (LINE / MIC) are set to "MIC" and the Microphone power supply switches are set to "DM" on the left side panel. In this condition, the input status display looks as below.

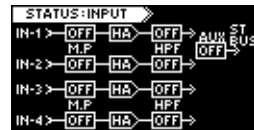

### (1) While the input status display is shown, press the [EDIT] key long enough.

The "OFF" icons change to the fast flashing "ENA" icons.

You can now edit enabled/disabled setting of the T12 power supply function. ("ENA" shows "Enable" setting, which is the default.)

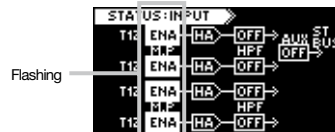

### (2) Press the [+] key to change "ENA" to "DIS", and press the [EDIT] key long enough.

The T12 power supply function is now disabled.

The display returns to the previous condition. (If you press the [-] key while the "DIS" icons are flashing, they are changed to "ENA".)

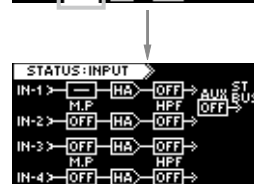
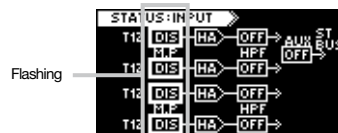

**<Memo>**: The T12 disabled/enabled setting remains even after you turn off the unit.

**<Memo>**: If you switch the microphone power supply switch of INPUT 1 to "T12", the input status display changes as below.

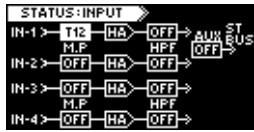
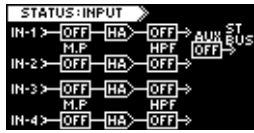

If you set the microphone power supply switch of INPUT 1 to "T12" and set the microphone power supply switches of INPUT 2 through INPUT 4 to "P48", the input status display looks as follows.

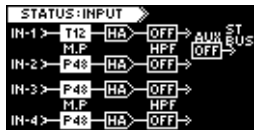

- (3) Press the [EDIT] key to exit the status display mode.

The display changes to the meter display.

**<Note>**: If you need to supply the T12 power, set the T12 power supply function to "ENA" by the similar procedure as above.

**<Memo>**: The T12 disabled/enabled setting remains even after you turn off the unit. However, if you initialize the flash memory using the system status display, it is reset to the default "ENA" setting (see page 24).

## Output status display

On the output status display, you can see the current status of the switches related to the outputs as well as the output sources.

Depending on the [SOURCE SEL] switch setting, the display looks as below.

### When the [SOURCE SEL] switch is set to "MIX"

The display shows the status of the switches shown below, as well as the output sources. The following shows the default setting when the unit is shipped. You can set the threshold and ratio of the limiter from this display.

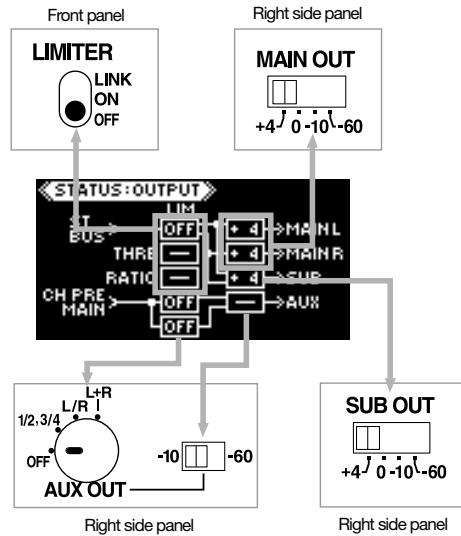

### When the [SOURCE SEL] switch is set to "DIRECT OUT"

The display shows the status of the switches shown below, as well as the output sources. The following shows the default setting when the unit is shipped.

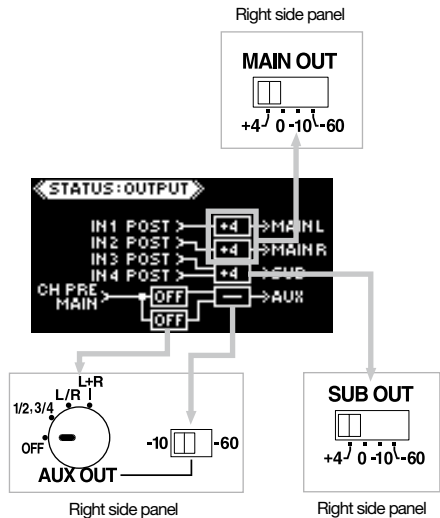

## Status information details

The following icons are shown according to the switch setting.

### • [LIMITER] switch status

When the [LIMITER] switch is set to “OFF”, the parameter boxes for the threshold and ratio show “—”. When the [LIMITER] switch is set to “ON” or “LINK”, the parameter boxes for the threshold and ratio show the current parameter values.

You can edit the parameter values by following the procedure described in the next page.

Switch setting		OFF	ON	LINK
Icon		OFF	ON	ON
	THRE	—	+12	+12
	RATIO	—	5:1	5:1

### • AUX OUT switch status

Switch setting		OFF	1/2, 3/4	L/R	L+R
Icon	Upper (AUX 1)	OFF	1/2	L/R	L+R
	Lower (AUX 2)	OFF	3/4	L/R	L+R

### • AUX OUT level switch

Switch setting		-10	-60
Icon		-10	-60

### • SUB OUT level switch

### • MAIN OUT (L, R) level switches

Switch setting	+4	0	-10	-60
Icon	+4	0	-20	-60

## Limiter parameter setting

By setting the [LIMITER] switch to “ON” (or “LINK”), the limiter function is enabled and you can apply the limiter to the stereo L/R buss.

The threshold level and ratio (compression ratio) of the limiter are set to “+12” and “5.1” respectively by default.

**<Note>**: In the following description, it is assumed that the [LIMITER] switch on the front panel is set to “ON” and the input status display looks as below.

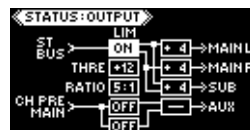

### (1) While the output status display is shown, press the [EDIT] key long enough.

“+12”, the current THRE value, starts flashing quickly.

You can now edit the threshold level.

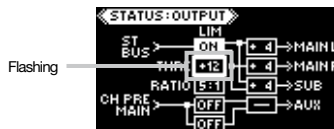

### (2) By pressing the [EDIT] key, you can alternately flash the THRE (“+12”) and RATIO (“5:1”) values.

To edit the threshold level, flash the THRE value (“+12”).

To edit the ratio, flash the RATIO value (“5:1”).

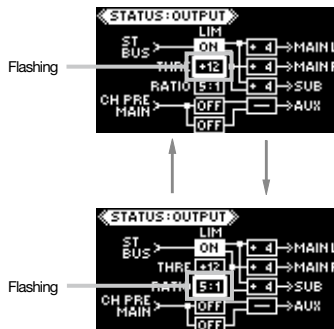

- (3) While the THRE value (“+12”) or the RATIO (“5:1”) is flashing, use the [+] or [-] key to select the desired value.

You can set the THRE value to “+12”, “+9” or “+6”, while you can set the RATIO value to “5:1” or “3:1”.

To select the threshold value:

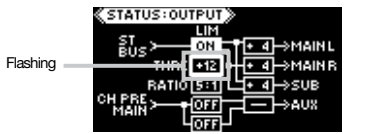

Press the [+] key ↑ Press the [-] key ↓

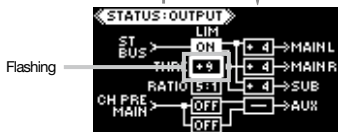

Press the [+] key ↑ Press the [-] key ↓

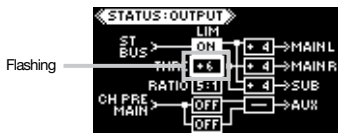

To select the ratio:

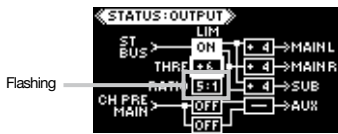

Press the [+] key ↑ Press the [-] key ↓

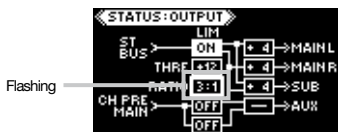

- (4) After selecting the desired value, press the [EDIT] long enough to stop flashing.
- (5) Press the [EDIT] key to exit the status display mode.

**<Memo>**: The limiter parameter setting remains even after you turn off the unit. If you initialize the flash memory using the system status display, it is reset to the default setting (see page 24).

## Meter status display

On the meter status display, not only you can see the current status of the metering, but also you can set parameters. The following shows the default setting when the unit is shipped.

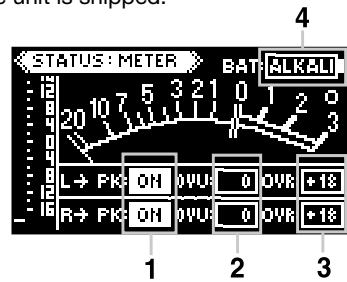

### (1) Peak meter ON/OFF

You can enable or disable the peak meter function for the left and right channels independently.

### (2) VU meter reference (0 VU) level

You can set the reference level for the left and right channels independently.

### (3) Threshold level of the peak over indicator

You can set the peak threshold level for the left and right channels independently.

### (4) Internal battery type

You can set the battery type between alkaline or nickel hydride.

## Parameter setting procedure

- (1) While the meter status display is shown, press the [EDIT] key long enough.

The peak meter on/off setting of the left channel (“ON”) starts flashing. You can now edit the peak meter on/off setting of the left channel.

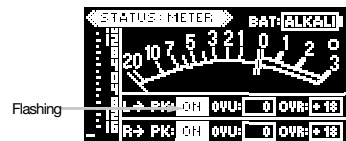

**<Memo>**: By bringing up the meter status display while the unit is receiving a signal, you can edit parameters while checking movement of the VU and peak meters.

- (2) While any parameter is flashing, press the [EDIT] key to select the flashing parameter.

Pressing the [EDIT] key selects the flashing parameter in the following order.

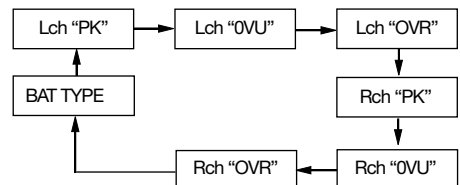

- (3) While the desired parameter to be edited is flashing, you can select a desired value using the [+ ] or [- ] key.

In the following display example, both the left and right peak meters are set to "OFF".

See "Parameter details" below for the available options of each parameter.

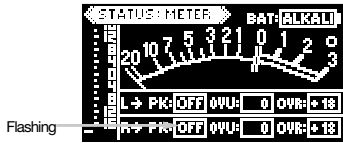

- (4) After editing parameters, press the [EDIT] key long enough to stop flashing.
- (5) Press the [EDIT] key to exit the status display mode.

### Parameter details

#### Peak meter on/off

<b>ON</b>	The meter display shows both VU and peak metering (default).
<b>OFF</b>	The meter display shows only VU metering. The peak metering is not shown.

#### VU meter reference level

<b>0</b>	The default value is "0 dB". You can select between "0 dB" and "+7 dB" in 1 dB steps.
<b>+ 7</b>	<b>&lt;Example&gt;</b> : If you set the reference level to "+5", the level at 0 VU is +5 dB higher than the reference level.

**<Memo>**: It is recommended to change the reference level appropriately when an external audio device connected to the outputs of the unit has enough headroom. Normally, set it to "0".

**<Memo>**: If you set the reference level other than "0", "+" is lit beside the "0" position of the VU meter, showing that the 0 VU level is not the reference level.

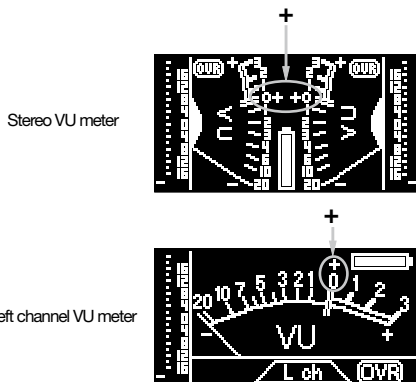

### Lighting level of peak over indicator

<b>0</b>	The default is "+18 dB". You can select between "0 dB" and "+18 dB" in 1 dB steps.
<b>+18</b>	

**<Memo>**: When peak level exceeds the lighting level, "OVER" is lit on the stereo meter display, as pointed by an arrow in the stereo meter display example below left. On the meter status display, "0" is lit as pointed by an arrow in the display example below right.

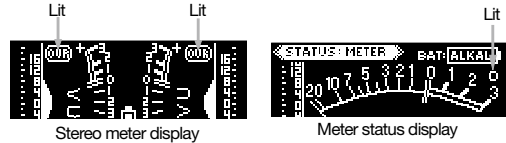

**<Memo>**: The details of the peak meter is as below.

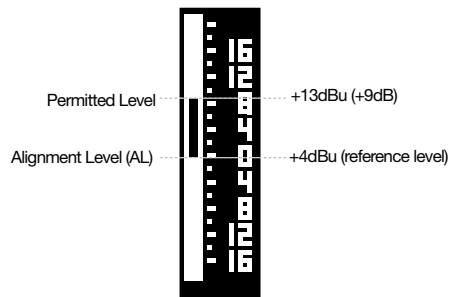

Scale	AL Level	PML Level	Attack Time	Fall Time	Peak Hold Time
-16 to +16	@ (Reference)	@+9dB	0.1msec.	1.7sec/20dB	2sec.

### Internal battery selection

<b>ALKALI</b>	When you use alkaline batteries, select this option.
<b>Ni-MH</b>	When you use nickel hydride batteries, select this option.

**<Note>**: This setting allows the EMPTY indicator and the alert for battery exchange work correctly according to the battery type. When you operate the unit on internal battery power, this item should be set correctly. Battery life depends on the battery type, battery condition and usage environment. It is recommended to exchange batteries when the EMPTY indicator starts flashing.

	INT DC		EXT DC
	Alkaline	Ni-MH	
EMPTY indicator flashing condition (approximately 30 minutes before batteries are completely exhausted)	Less than 8.1 V	Less than 9.2 V	Less than 7.0 V
Alert for battery exchange*	Less than 7.5 V	Less than 8.6 V	
Audio mute	Less than 6.1 V	Less than 6.1 V	Less than 6.1 V

\* "Please change battery!" is shown as alert for battery exchange.

## System status display

On the system status display, not only you can see the following information, but also you can reset the time display and initialize the flash memory.

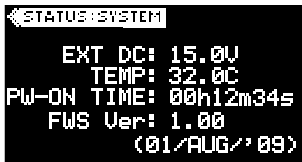

- (1) **Power voltage (EXT DC or INT DC)**  
This item shows the voltage of the current power source.  
When the [POWER] switch is set to "INT", this item shows "INT DC" and the voltage of the internal batteries.  
When the [POWER] switch is set to "EXT", it shows "EXT DC" and the voltage of the external power source.
- (2) **Temperature inside the unit (TEMP)**  
This item shows the temperature inside the unit.  
The temperature significantly affects the battery performance.  
Generally, in a low temperature environment, the battery life of primary battery (e.g. alkaline) gets shorter.
- (3) **Power-on time**  
This item shows the elapsed time since the unit is powered on. The time display is running in realtime.

**<Memo>**: By pressing the [EDIT] key long enough while the system status display is shown, you can reset this item to "00h00m00s".

**<Memo>**: The time display is automatically reset to "00h00m00s" after powering off the unit.

- (4) **Firmware version**  
This item shows the firmware version of the unit.

## Initializing the flash memory

You can initialize the flash memory to the condition when the unit is shipped from the factory. To initialize the flash memory, press and hold down the [EDIT] key for 10 seconds or more while the system status display is shown. When the memory initialization is completed, the system status display is dismissed and the display shows the stereo VU meter display.

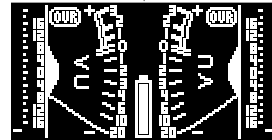
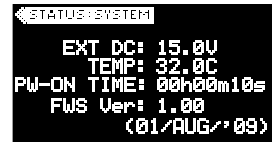



# Specifications

## Inputs/Outputs

\* 0dBu = 0.775Vrms

### <Analog Inputs>

#### [INPUT] 1 through [INPUT] 4

- Connector: XLR-3-31 type (transformer balanced)

##### <LINE input>

- Input impedance: 10 k $\Omega$  or more
- Nominal input level: -20 dBu to +4 dBu
- Maximum input level: +29 dBu

##### <MIC input>

- Input impedance: 2 k $\Omega$  or more
- Nominal input level: -70 dBu to -30 dBu
- Maximum input level: -5 dBu

#### [AUX IN]

- Connector: XLR-5-51 type (electronically balanced)
- Input impedance: 20 k $\Omega$  or more
- Nominal input level: +4 dBu
- Maximum input level: +29 dBu

#### [RTN]

- Connector: 3.5mm stereo mini-phone jack (unbalanced)
- Input impedance: 10 k $\Omega$  or more
- Nominal input level: -10 dBV
- Maximum input level: +15 dBV

### <Analog Outputs>

#### [MAIN OUT] (L/1, R/2)

- Connector: XLR-3-32 type (transformer balanced)
- Applicable load impedance: 600  $\Omega$  or more
- Nominal output level: +4, 0, -10 or -60 dBu (switchable)
- Maximum output level: +24, +20, +10 or -40 dBu (switchable)

#### [SUB OUT] (L/3, R/4)

- Connector: XLR-3-32 type (electronically balanced)
- Applicable load impedance: 10 k $\Omega$  or more
- Nominal output level: +4, 0, -10 or -60 dBu (switchable)
- Maximum output level: +24, +20, +10 or -40 dBu (switchable)

#### [TAPE OUT]

- Connector: 3.5mm stereo mini-phone jack (unbalanced)
- Applicable load impedance: 10 k $\Omega$  or more
- Nominal output level: -10 dBV
- Maximum output level: +10 dBV

#### [AUX OUT] (1, 2)

- Connector: 3.5mm stereo mini-phone jack (unbalanced)
- Applicable load impedance: 10 k $\Omega$  or more
- Nominal output level: -10 dBV or -60 dBV (switchable)
- Maximum output level: +10 dBV or -40 dBV (switchable)

#### [PHONES]

- Connectors:
  - 1/4" stereo phone jack and 3.5 mm stereo mini-phone jack
- Applicable load impedance: 8  $\Omega$  or more
- Maximum output power:
  - 50 mW (at 32  $\Omega$  load, THD: 0.1 % or less)

### <Others>

#### [DC IN]

- Connector: XLR-4-32 type (male)
- Input voltage: DC 10 V to DC 24 V

#### [DC OUT]

- Connector: Hirose 4 pin (female)
  - \* Applicable plug: Hirose HR10A-7P-4P
- Output voltage: DC 7.2 V - 24 V (Max. 0.5 A)

## Performance

#### Frequency response

- LINE IN - MAIN OUT:
  - 20 Hz to 20 kHz +/- 1 dB (reference level)
- MIC IN - MAIN OUT:
  - 40 Hz to 20 kHz +/- 1 dB (reference level)
- HEADPHONES (32  $\Omega$  load, 25 mW output power):
  - 20 Hz to 20 kHz +/- 3 dB

#### S/N ratio (A-weighted)

- LINE (INPUT GAIN: +4 dBu): 80 dB or better
- MIC (INPUT GAIN: -70 dBu): 55 dB or better (equivalent input noise: -125 dBu)

#### Total harmonic distortion

0.1% or less at 1 kHz

#### Headphones residual noise (PHONES level control at minimum)

-72 dBV or less (A-weighted)

#### Crosstalk:

-70 dB or less at 1kHz

## Others

### Phantom power:

P48 (phantom 48 V) and T12 (A-B 12 V) power supply circuit for each input channel.

\* T12 power supply can be disabled or enabled using the status mode.

### HPF (High pass filter)

40 Hz to 200 Hz, -12 dB/oct.

The cutoff frequency is continuously sweepable.

### EQ (equalizer):

#### • HI:

Type: Shelving

Cutoff frequency: 10 kHz (fixed)

Boost/cut range: -12 dB to +12 dB

#### • MID:

Type: Sweepable

Center frequency: 200 Hz to 8 kHz (sweepable)

Boost/cut range: -12 dB to +12 dB

### Slate microphone / slate tone

Slate tone: 1kHz

Slate microphone: built in the unit

### Level meter

VU and peak level meters

Stereo/mono metering selectable

### Limiter

Attack time: approximately 5 msec.

Release time: approximately 200 msec.

Threshold level: +6 dB, +9 dB or +12 dB

Ratio: 3:1 or 5:1

\* Threshold level and ratio can be selected using the status mode.

## General

### External dimensions:

274 (W) x 57 (H) x 180 (D) mm (Including protrusions)

### Weight:

Approximately 1.5 kg (not including battery box)

Approximately 1.7 kg (including the battery box and eight AA alkaline batteries)

### Power:

Internal batteries: Eight AA batteries (alkaline: 12 V, nickel hydride: 9.6 V) Power requirement: DC 7.2 to 12 V

External power supply: Optional AC adaptor

Recommended external battery voltage: DC12 to 24V

Power requirement: DC10 to 24 V

### Power consumption:

Approximately 4.0 W

### Operation condition:

Temperature: -10 °C to +50 °C

Humidity: 85% or less (no moisture condensation)

### Supplied accessories:

Battery box, Owner's manual

## Operation time with batteries (for reference)

### Measurement condition: 20° C temperature, 60% humidity

Battery type	Microphone power supply	
	OFF (DM)	ON (P48 x 3)
Alkaline (LR6)	Approx. 5.5 hours	Approx. 4.5 hours
Ni-MH (SANYO eneloop)	Approx. 6.5 hours	Approx. 5.5 hours
Ni-MH (SANYO 2700mAh)	Approx. 7.5 hours	Approx. 7.0 hours

### Measurement condition: 0° C temperature, saturated humidity

Battery type	Microphone power supply	
	OFF (DM)	ON (P48 x 3)
Alkaline (LR6)	Approx. 2.5 hours	Approx. 2.0 hours
Ni-MH (SANYO eneloop)	Approx. 6.5 hours	Approx. 5.5 hours
Ni-MH (SANYO 2700mAh)	Approx. 7.5 hours	Approx. 6.5 hours

### Measurement condition: +45° C temperature, 60% humidity

Battery type	Microphone power supply	
	OFF (DM)	ON (P48 x 3)
Alkaline (LR6)	Approx. 7.0 hours	Approx. 5.5 hours
Ni-MH (SANYO eneloop)	Approx. 7.0 hours	Approx. 5.5 hours
Ni-MH (SANYO 2700mAh)	Approx. 8.0 hours	Approx. 7.0 hours

**<Note 1>**: The operation time data shown above is for reference only. The actual operation time depends on the operational condition or circumstance.

**<Note 2>**: The more time the nickel hydride battery is charged or discharged, the maximum capacity decreases.

**<Note 3>**: The data shown above is measured using nickel hydride batteries that has been fully charged just before. Because a nickel hydride battery self-discharges, it is recommended to charge nickel hydride batteries just before using. Also it is recommended to use batteries whose self-discharge rate is low (e.g., SANYO eneloop).

**<Note 4>**: Use eight batteries of the same type and same capacity.

**<Memo>**: Lower the operation temperature is, shorter the life of a primary battery (e.g alkaline) is. When you use the unit in a place where temperature is low, it is recommended to use nickel hydride batteries.

\* Specifications and appearance are subject to change without notice for product improvement.

# External dimensions

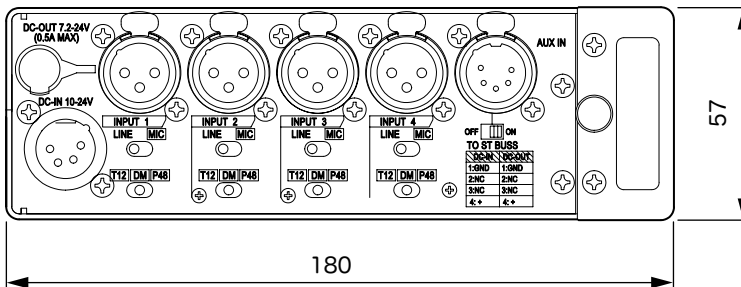
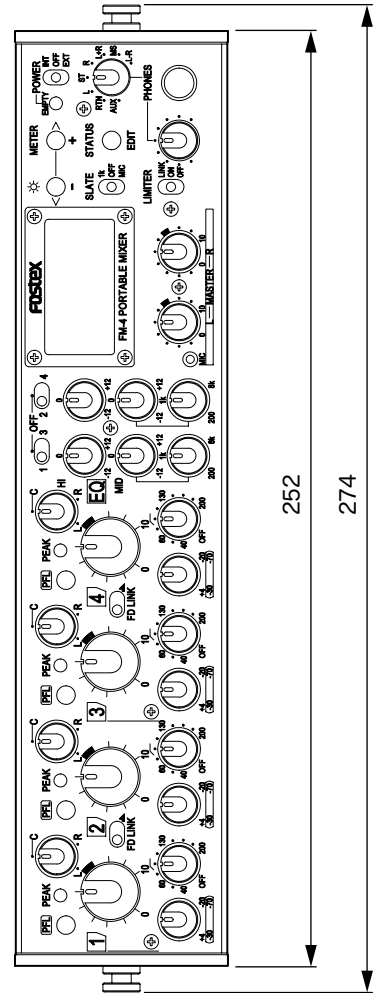
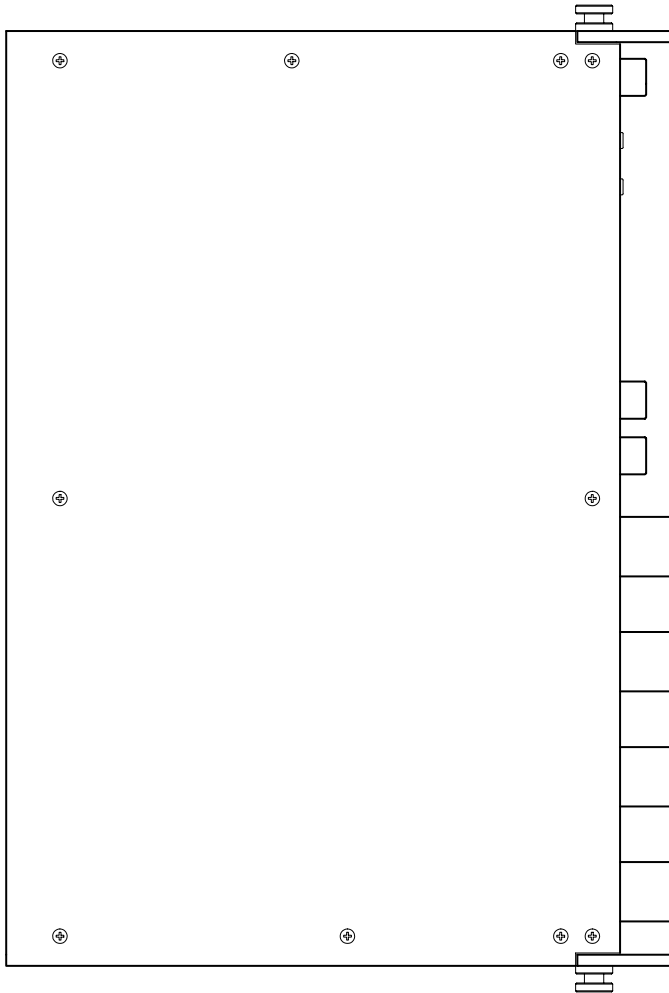
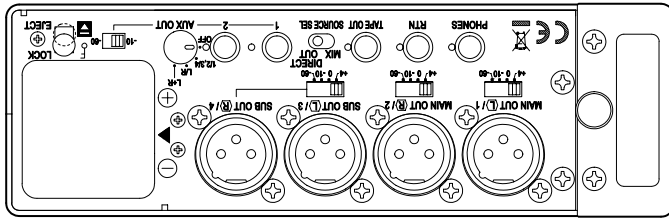

**Memo**

## Declaration of EC Directive

This equipment is compatible with the EMC Directive (2004/108/EC) - Directive on approximation of member nation's ordinance concerning the electromagnetic compatibility and with the Low Voltage Directive (73/23/EEC) - Directive on approximation of member nation's ordinance concerning electric equipment designed to be used within the specified voltage range.

### The Affect of Immunity on This Equipment

The affect of the European Specification EN61000-6-1 (coexistence of electromagnetic waves - common immunity specification) on this equipment are as shown below.

In the electrical fast transient/burst requirements, surge, conducted disturbances by radio-frequency fields, power frequency magnetic field, radiate electromagnetic field requirements and static electricity discharging environment, this could be affected by generation of noise in some cases.

## FOSTEX DISTRIBUTORS LIST IN EUROPE

\* Including non-EU countries (as of June 2009)

### <AUSTRIA>

NAME: ATEC Audio-u. Videogeraete VertriebsgesmbH.  
ADD: Im Winkel 5, A-2325 Velm, Austria  
TEL: (+43) 2234-74004, FAX: (+43) 2234-74074

### <BELGIUM>

NAME: General Audio  
ADD: Raymond Pelgrimslaan 101, B-1702 Groot-Bijgaarden, Belgium  
TEL: (+32) 2-4630650, FAX: (+32) 2-4661500

### <DENMARK>

NAME: Benum Nordic A/S  
ADD: Meterbuen 18, Skovlunde, 2740 Denmark  
TEL: (+45) 4451-8900, FAX: (+45) 4451-8911

### <FINLAND>

NAME: Noretron Oy Audio  
ADD: P. O. Box 22, FIN-02631 Espoo, Finland  
TEL: (+358) 9-5259330, FAX: (+358) 9-52593352

### <FRANCE>

NAME: Sennheiser France  
ADD: 128 bis, avenue Jean-Jaures, 94851 Ivry-sur-Seine Cedex, France  
TEL: (+33) 1 4987 0300, FAX: (+33) 1 4987 0324

### <GERMANY>

NAME: Mega Audio GmbH  
ADD: Stromberger Str. 32, D-55411 Bingen, Germany  
TEL: (+49) 6721-94330, FAX: (+49) 6721-32046

### <GREECE>

NAME: Bon Studio S. A.  
ADD: 6 Zaimi Street, Exarchia, 106,83 Athens, Greece  
TEL: (+30) 210-3809-605, 606, 607, 608  
FAX: (+30) 210-3845-755, 210-3827-868

### <ICELAND>

NAME: I. D. elrf. electronic Ltd.  
ADD: ARMULA 38 108 REYKJAVIK, ICELAND  
TEL: (+354) 588 5010, FAX: (+354) 588 5011

### <ITALY>

NAME: Proel S. p. A.  
ADD: Zona Via Alla Ruenia, 37/43 64027 - Sant'Omero (Teramo), Italy  
TEL: (+39) 0861-81241, FAX: (+39) 0861-887862

### <THE NETHERLANDS>

NAME: IEMKE ROOS AUDIO B. V.  
ADD: Kuiperbergweg 20, 1101 AG Amsterdam, The Netherlands  
TEL: (+31) 20-697-2121, FAX: (+31) 20-697-4201

### <NORWAY>

NAME: Siv. Ing. Benum AS  
ADD: P. O. Box 145, Vinderen, 0319 Oslo, Norway  
TEL: (+47) 2213 9900, FAX: (+47) 2214 8259

### <SPAIN>

NAME: Letusa S. A.  
ADD: C/Laguna 10, 28923 Alcorcon, Madrid, Spain  
TEL: (+34) 91-4862800, 91-4470898, FAX: (+34) 91-6414597

### <SWEDEN>

NAME: Benum Nordic A/S  
ADD: Aldermansvagen 17, 171 48 Solna, Sweden  
TEL: (+46) 8 207710

### <SWITZERLAND>

NAME: Audio Bauer Pro AG  
ADD: Bernerstrasse-Nord 182, CH-8064 Zurich, Switzerland  
TEL: (+41) 1-4323230, FAX: (+41) 1-4326558

### <UK>

NAME: SCV London  
ADD: 40 Chigwell Lane, Oakwood Hill Industrial Estate, Loughton, Essex IG10 3NY U. K.  
TEL: (+44) 20-8418-0778, FAX: (+44) 20-8418-0624

## FOR THE US CUSTOMERS ONLY

### FOSTEX AMERICA LIMITED WARRANTY

The following statement defines specific legal rights. You may also have additional rights depending on the state in which the Fostex product was purchased.

#### WARRANTY PROTECTION

All Fostex parts are warranted for one (1) year from the date of original purchase, except for recording media, such as hard disc drives and compact flash cards, heads, lamps and fuses, which are warranted, for one hundred-eighty (180) days. Fostex America will repair and / or replace parts during the term of this warranty. Labor costs are also covered by Fostex America for one (1) year from the date of original purchase. Except as specified below, this warranty covers all defects in material and workmanship in this product.

The following are not covered by this warranty:

1. Batteries.
2. Damage to any product that has been altered.
3. Damage to any product on which the original serial number has been defaced, modified or removed.
4. Damage to or deterioration of the external cabinet.
5. Damage occurring during shipment of the product. (NOTE: Shipping claims must be presented to the carrier.)
6. Damage resulting from accident, misuse, abuse or neglect.
7. Damage resulting from failure to perform routine maintenance and / or calibration procedures.
8. Damage resulting from failure to follow instruction in the owner's manual.
9. Damage resulting from repair or attempted repair or by someone other than a Fostex America Service technician or a technician at an authorized Fostex America service station.
10. Damage resulting from causes other than product defects, including lack of technical skill, competence or experience on the part of the user.
11. External appearance items such as cosmetic parts, knobs, liquid crystal displays, buttons, etc.
12. Replacements or repairs necessitated by loss or damages resulting from any cause beyond the control of Fostex America.
13. Damage resulting from misuse or abuse on rental units.

**NOTE: FOSTEX AMERICA IS NOT RESPONSIBLE FOR DATA LOST OR DAMAGED DURING OPERATION OF THIS PRODUCT. CALIBRATION AND MAINTENANCE PROCEDURES ARE NOT COVERED BY THIS WARRANTY.**

Fostex America reserves the right to inspect all products submitted pursuant to this warranty. If such an inspection shows reasonable cause to believe that any of the above exclusions to the above warranty are applicable, then Fostex America or the authorized service station will charge prevailing service rates and parts, costs for any repairs.

# FOSTEX AMERICA LIMITED WARRANTY

To claim all warranty service, first access [www.fostex.com](http://www.fostex.com) to receive service authorization (RMA number). Then present the authorization together with the bill of sale, which shows the date of original purchase to Fostex America. This warranty is not transferable.

## SHIPPING

If this product needs service, you must take it, or package it carefully, using ample packaging materials to prevent damage during shipment and mail it to the distributor from whom you have purchased this product, postage pre-paid and insured. **NOTE:** Fostex America will not assume responsibility for damages or losses occurred in transit, but will reasonably assist the sender in processing any claims whenever possible (such as submitting statements to the carriers when applicable).

Any collect or C.O.D. shipments will be refused. In order to obtain warranty repairs, you must include the following:

1. Date proof of original purchase (copy of bill of sale or charge slip).
2. A note describing the problem with sufficient particularity to allow Fostex America to inspect or adjust the problem.
3. All accessory items appurtenant to that problem.

## LIMITATIONS OF IMPLIED WARRANTIES AND EXCLUSIONS OF CERTAIN DAMAGES

Unless considered unenforceable or unlawful under applicable law:

- A. All implied warranties - including warranties of merchantability and fitness for a particular purpose - are limited in duration to term of this warranty and to the express coverage of this warranty;
- B. Fostex America's liability for any defect product is expressly limited to repair or replacement of the product, at the sole discretion and / or option of Fostex America. Fostex America shall not under any circumstances be liable for:
  1. Damaged based on inconvenience, loss of use of the product, loss of time, interrupted operation or commercial loss, OR;
  2. Any damages, whether incidental, consequential or otherwise, except damages which may not be excluded by under applicable law.
- C. Fostex America makes no other warranties, express or implied, above and / or beyond the representations made herein.

WARRANTY APPLIES ONLY TO THOSE PRODUCTS SOLD AND DISTRIBUTED BY FOSTEX AMERICA

### Service Department

FOSTEX AMERICA

Please visit [www.fostex.com](http://www.fostex.com) for the latest contact information.

**Fostex**

**FOSTEX CO.**

3-2-35, Musashino, Akishima-shi, Tokyo Japan, 196-0021