

# DMT-8 Version 2.0

## Supplement to the Owner's Manual

*This document describes the upgraded functions of the DMT-8 Version 2.0. You Will find the DMT-8 Owner's Manual and this supplemental manual, which explains the extended functions of Version 2.0, packaged with the product. Before using the DMT-8, please read both manuals thoroughly to understand the correct operation of the unit. Refer to the main Owner's Manual for functions other than those referred to in this supplement.*

### ***Changed or added functions***

*The following function have been changed or added in DMT-8 Version 2.0:*

- 1. You can control up to five songs on a single hard disk. Also, a new Program Change function has been added.*
- 2. The Move & paste function, as well as the Copy & Paste function, is available Pasting data to any individual track, as well as pasting to multiple tracks simultaneously.*
- 3. The following functions have been changed and/or added in SETUP mode:
  - \* Expanded "SAVE" function (saving data to an external DAT).*
  - \* Improved precision of the "MTC OFFSET" parameter (MTC offset value9.*
  - \* "dG in" (selecting a digital input channel) has been added.*
  - \* "dG out" (selecting a digital output channel) has been added.*
  - \* "rESoLu" (setting Display Resolution mode ON/OFF) has been added.*
  - \* "SLAvE" (setting Slave mode ON/OFF) has been added.*
  - \* "dFvicE" (setting a device ID) has been added.*
  - \* "Undo" (setting an effective range of the Undo function) has been added.**
- 4. Compatible with Fostex System exclusive Message to allow for editing from an external device via MIDI.*
- 5. A new function to merge and output MMC/FEX (Fostex System Exclusive Message) and MTC.*
- 6. The maximum number of changing points in a Tempo Map is new 64 for a time signature, and 64 for a tempo.*

# Table of Contents

<i>Before Operating the DMT-8 Version 2.0</i> .....	3
1. <i>Program Change function</i> .....	4
2. <i>Copy &amp; Paste and Move &amp; Past</i> .....	6
<i>Difference between Copy &amp; Paste and Move &amp; Paste</i> .....	6
<i>Procedure for Copy &amp; Paste and Move &amp; Paste</i> .....	6
<i>Copying the data</i> .....	7
<i>Specifying and storing the Start pint</i> .....	7
<i>Specifying and storing the End point</i> .....	7
<i>Copying</i> .....	8
<i>Checking the copied data</i> .....	8
<i>Executing the Copy &amp; Paste function</i> .....	9
<i>Specifying and storing the Copy &amp; Paste start point</i> .....	9
<i>Executing the Copy &amp; Paste operation</i> .....	9
<i>Undo/Redo of the Copy &amp; Paste operation</i> .....	11
<i>Using the Move &amp; Paste function</i> .....	11
<i>Executing the Move &amp; Paste operation</i> .....	12
<i>Undo/Redo of the Move &amp; Paste operation</i> .....	13
<i>Notes on Cut/Erase</i> .....	13
3. <i>Changing and Added function in Setup mode</i> .....	14
3-1. <i>Saving recorded data ("SAVE")</i> .....	15
<i>Saving data to DAT (SAVE)</i> .....	16
<i>Loading from the DAT machine</i> .....	17
3-2. <i>Setting the MTC offset time ("MTC OFFSET")</i> .....	19
3-3. <i>Setting a digital input channel ("dG in")</i> .....	19
<i>Recording digitally from an external device</i> .....	20
3-4. <i>Setting a digital output channel (dG out")</i> .....	21
<i>Recording digitally to an external device</i> .....	22
3-5. <i>Setting Display Resolution mode On/Off ("rESoLu")</i> .....	23
3-6. <i>Setting Slave mode On/Off ("SLAvE")</i> .....	24
<i>Synchronizing multiple DMT-8s in Slave mode</i> .....	25
<i>Checking the sync operation</i> .....	25
3-7. <i>Setting MIDI device ID ("dEVicE")</i> .....	26
3-8. <i>Setting the Undo function range (Undo")</i> .....	27
4. <i>Compatible with Fostex System Exclusive Message</i> .....	28
5. <i>A new output function that merges MMC/FEX and MTC internally</i> .....	28
6. <i>The maximum number to Tempo Map change points     is new 64 for a time signature, and 64 for a tempo</i> .....	29
<i>Fostex MIDI System Exclusive Message Format for DMT-8 Ver 2.0</i> .....	30
<i>Fostex System Exclusive message</i> .....	30
<i>Status Request</i> .....	31
<i>Data type</i> .....	32
<i>Explanation on the Command/Mode set</i> .....	33
<i>The status request command</i> .....	36
<i>Explanation on the status reply</i> .....	38

## Before Operating the DMT-8 Version 2.0

Part of the key function has been changed in Version 2.0. Be sure to place the "key name" label included in the package as shown below. This label will allow you to identify each key clearly and help you understand the explanation in this manual. Refer to the following description regarding the changed key functions.

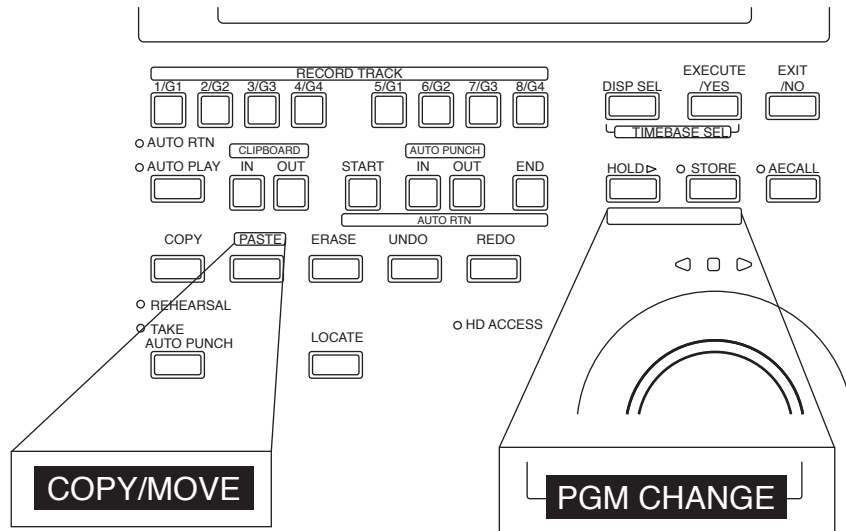

The following functions have been added to the HOLD/> key, STORE key, and PASTE key.

1. Pressing the STORE key while holding down the HOLD/> key allows you to select a Program. You can select a Program any time other than when the recorder section is in REC mode or Play mode.  
Refer to "Program Change function on the next page for details.
2. The Move & Paste function has been added to the PASTE key.  
Using this key allows you to select whether you execute the Copy & Paste function or the Move & Paste function. Refer to "Copy & Paste/ Move & Paste" on page 6 for details.

## 1. Program Change function

The Program Change function allows you to select any of five Programs (1-5) to which the hard disk space is allotted, so you can record, playback, edit, and archives up to five songs individually on a single hard disk (as long as there is adequate free space on the disk). You can create an individual song, so that for example the first song is in Program 1, the second song in Program 2 etc.

To perform recording, playback, edit, and archives, first select a desired Program.

### How to switch a Program

\* You can select a Program any time other than when the recorder section is in REC mode or PLAY mode.

When you turn on the power to the DMT-8, a Program with the Time Base used before you turned off the power will be selected. (When you turn on the power to the unit for the first time after unpacking, the DMT-8 will start with Program 1 with "ABS TIME" base.) Make sure that the DMT-8 is stopped when you select a Program.

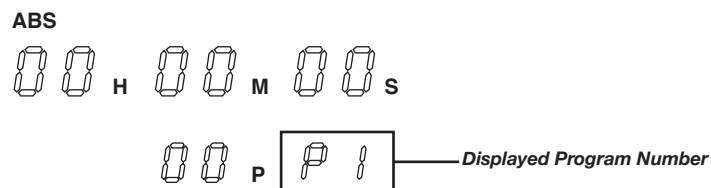

Here, let's assume that Program 1 with "ABS TIME" display was selected when you turned on the power to the DMT-8.

1. While the screen shown above is displayed, pressing the STORE key while holding down the HOLD/> key and repeatedly to switch Programs from P1 through P5.

The following figure indicates that each Program with a Time Base of "ABS" is selected.

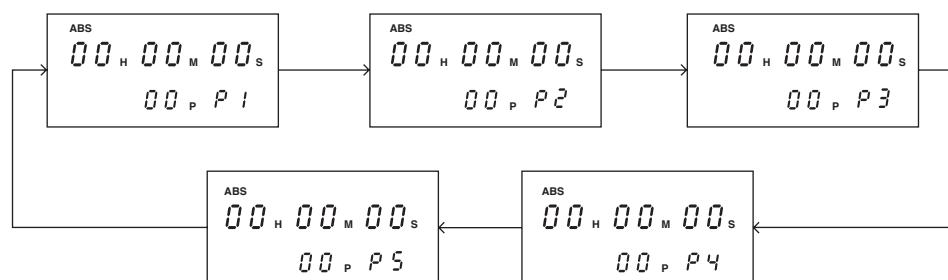

If the Time Base for each Program is different, something similar to the following figure will appear. In this example, Program 1 has a Time Base of "ABS Time", Program 2 with a Time Base of "BAR/BEAT/CLK", Program 3 with "MTC TIME", and Programs 4 and 5 with "ABS TIME".

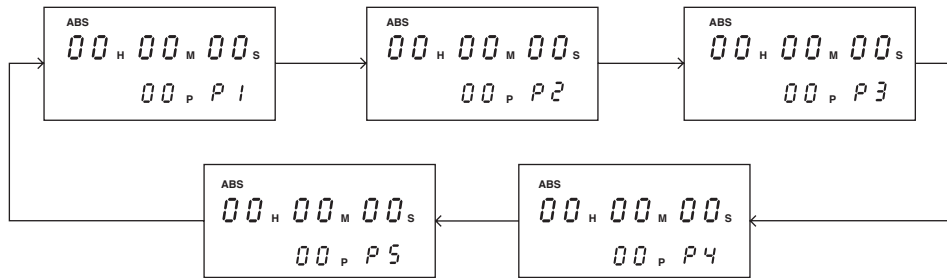

**<Note>**

You can record up to about 12.5 minutes total for all five Programs. That is, if you have recorded one 12-minute Program, you cannot record anything in any other Programs as shown in the diagram below. Check the REMAIN display for available recording time before recording.

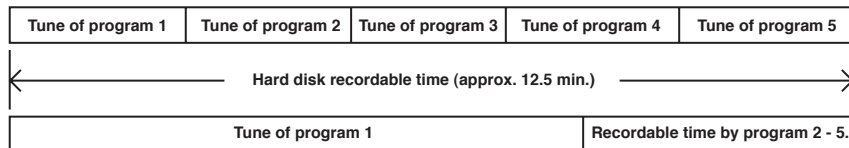

**<Note>**

The new Program Change function has changed the way you use "SAVE" in Setup mode as compared to the original explanation in the main manual. refer to pages 15~18 of this supplement for detailed operation.

## 2. Copy & Paste and Move & Paste

A new Move & Paste function is available, in addition to the Copy & Paste function.

Formerly, you could paste data in the copy source track. Now, you can also paste in a track other than the Copy or Move source track. It is possible to specify the number of times (0-99) you wish to paste the same data repeatedly.

### Difference between Copy & Paste and Move & Paste

- \* The Copy & Paste function pastes data (that is copied on the Clipboards shown below) to any location of any track. The copy source data remains intact.
- \* The Move & Paste function is almost the same as the Copy & Paste, except that exciting the Move & Paste function will erase the move source data (the Clipboard will be also cleared).

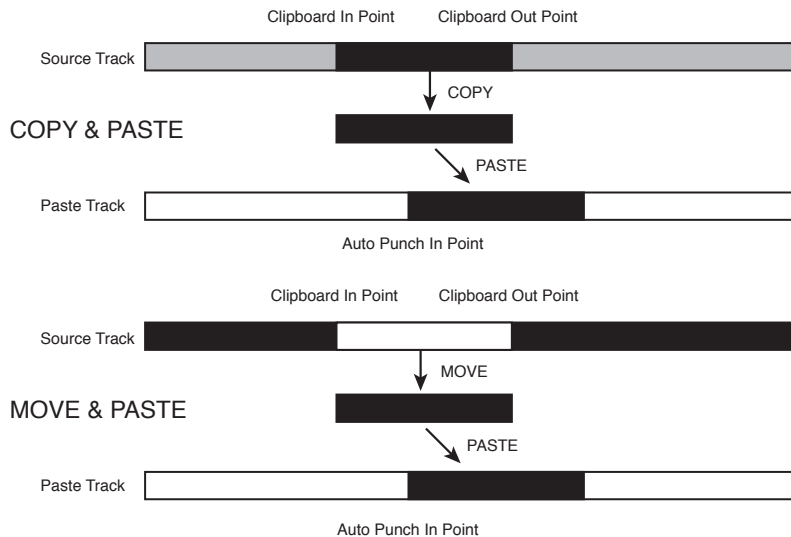

### Procedure for Copy & Paste and Move & Paste

(The first two steps are same for either function.)

1. Store the copy start point (CLIPBOARD IN point) and the end point (CLIPBOARD OUT point) to copy the data into the Clipboard, select the copy source track, and press the COPY key.
2. Store the paste start point (AUTO PUNCH IN point) to specify location to paste.
3. Pass the PASTE key, and select "Copy & Paste" or "Move & Paste". (Pressing the PASTE key will toggle between these two points.) Select a paste destination track, enter this number of repeat to paste, and press the EXECUTE/YES key.

## Copying the data

*\* The following procedure is based on data with the ABS Time Base. To change the Time Base to MTC or MIDI BAR/BEAT CLK, press the DISP SEL key while pressing and holding down the EXECUTE/YES key.*

### Specifying and storing the Start point (Clipboard In point)

1. Press the RECALL key, then the CLIPBOARD IN key (or predd only the CLIPBOARD IN key) to enter edit mode.
2. Select the digit to edit using the HOLD/> key on the SHUTTLE dial, and use the JOG dial to set a desired time value.
3. Press the STORE key, then the CLIPBOARD IN key.  
The specified time will be stored at the CLIPBOARD IN key as the copy start point (clipboard In point), and the DMT-8 will quit edit mode, displaying the previous screen.

*\* You can store the start point in real-time instead of following Steps 1-3 described above. (While playing back the data, predd the STORE key, the CLIPBOARD IN key.)*

### Specifying and storing the End point (Clipboard In point)

4. Press the RECALL key, then the CLIPBOARD OUT key (or predd only the CLIPBOARD OUT key) to enter edit mode.
5. Select the digit to edit using the HOLD/> key or the SHUTTLE dial, and use the JOG dial to set a desired time value.
6. Press the STORE key, then the CLIPBOARD OUT key.  
the specified time will be stored at the CLIPBOARD OUT key as the copy end point (Clipboard Out point), and the DMT-8 will quit edit mode, displaying the previous screen.

*\* To check to see if the correct In/Out points have been stored, press the CLIPBOARD IN/CLIPBOARD OUT keys. The display will show the stored time value.*

#### **Hints;**

*When you are sorting the In/Out points in real-time while using the "BAR/BEAT/CLK" Time Base, you can store then in steps of beats if the "rESoLu" (Display Resolution mode On/Off) in Setup mode is "ON". When this resolution mode is "ON" the CLK value will be rounder up or off to "00" (at the beginning of the data) as soon as you press the STORE key.*

*This function is useful when you wish to use the Copy & Paste or Move & Paste function in steps of beats.*

*Refer to page 23 of this supplement for detailed operation.*

Copying

7. Select a copy source track using the RECORD TRACK select key.

*\* You can select a mono track or multiple tracks.*

*When using the Copy & Paste or Move & Paste function, however, you can change the paste destination track only when you have selected a mono track, or an odd-numbered track and the adjacent even-numbered track (i.e.; 1-2, 3-4, 5-6, 7-8).*

*If you have copied multiple tracks (other than the above combination), the data will be pasted to the copy source tracks. (track 1 -> track 1... ..track 3 -> track 3 etc.)*

8. Press the COPY key.

*The data will be copied immediately. The display will show Copy Clip", the "COMPLETED!" and returns to the previous screen.*

*Now, the specified sound data has been copied onto the Clipboard as paste data. Follow the procedure below to use the Copy & Paste operation, or the Move & Paste operation.*

*\* The setups up to here apply to both the Copy & Paste function and the Move & Paste operation, since you will eventually select one of the functions before you press the PASTE key.*

**< Note >**

*If you press the COPY key without selecting a copy source track by the RECORD TRACK select key, the display will show "SELECT trk" (meaning "select a track.") and return to the previous screen.*

*In this case, select a copy source track and try again to copy the data.*

**< Note >**

*If the Out point has been specified before the In point (the In point value is the same or larger than the Out point value), the display will show the error message "Void In" or "Void Out" and return to the previous screen.*

*In this case, set correct In/ Out points and try again to copy the data.*

**< Note >**

*You can copy a set of data into the Clipboard. If you copy another set of data, the existing data in the Clipboard will be over written by the new one.*

Checking the copied data

*You can listen to the copied data on the Clipboard (Clipboard Play function).*

*To listen to the copied data, press the PLAY button while pressing and holding down the STOP button (Clipboard Play mode).*

*The data will be played back from the beginning. To stop monitoring the data, press the STOP button.*



*\* During Clipboard Play mode, the indicator of the copied track will blink and the selected Time Base will show the position of the copy source.*

## ***Executing the Copy & Paste function***

### **< Note >**

*You need enough unrecorded space on the hard disk to execute the Copy & Paste operation.*

*If you press the EXECUTE/YES key to try to paste with insufficient disk space, the display will immediately show the error message "Over time", then show the excess time using the currently-selected Time Base (time or bar). In this case, shorten the copy data by the amount of excess time. Alternatively, move ABS END backward using the CUT function as described in page 89 of the DMT-8 main manual in order to obtain more free space on the disk.*

### **< Note >**

*You can select Copy & Paste destination tracks other than the copy source track only when you have selected a mono track, or an odd-numbered track and the adjacent even-numbered track (i.e.; 1-2, 3-4, 5-6, 7-8) as source tracks.*

*If you have copied tracks other than the above combination, such as 1-5 or 3-8, the data will be copy & pasted to the copy source tracks.*

### **Specifying and storing the copy & paste start point (Punch In point)**

*This start point can be used for both Copy & Paste operation and Move & Paste operation.*

- 1. Press the RECALL key, then the AUTO PUNCH IN key (or press only the AUTO PUNCH IN key) to enter edit mode.*
- 2. Select the digit to edit using the HOLD/> key or the SHUTTLE dial, and use the JOG dial to set a desired time value.*
- 3. Press the STORE key, then the AUTO PUNCH IN key.*

*The specified time will be stored as the paste start point, and the DMT-8 will quit edit mode, displaying the previous screen.*

*\* To check to see if the correct In point have been stored, press the AUTO PUNCH IN key. The display will show the stored time value.*

### **Executing the Copy & Paste operation**

*\* The data on the Clipboard remain unchanged after you execute the Copy & Paste operation. Therefore, you can paste the same data as many times as you wish. (However, the data on the Clipboard will be cleared after executing the Move & Paste operation.)*

4. Press the PASTE key.

Pressing the key repeatedly will change the display indication in the following order; "coPy PAsT" ->-> (after one second) ->-> "rPt 01 PAsT ARE YOU SURE?" (ready for the Copy & Paste operation), alternatively "movE PAsT" ->-> (after one second) ->-> "rPt 01 movE ARE YOU SURE?" (ready for the Move & Paste operation). In this procedure, select "rPt 01 PAsT ARE YOU SURE?" to execute the Copy & Paste operation. The copy source track number will light up, and "01" will blink indicating that the number of repeats to paste is "one".

5. Specify the copy destination track and the number of repeats to paste.

\* Specifying the copy & paste destination track;  
select the destination track using the RECORD TRACK select key. (You do not need to specify the track if you are going to copy & paste data in the copy source track.)

\* Specifying the number of repeats to copy & paste;  
Turn the JOG dial to change the blinking number "01" to any value between 01 and 99. (If there is not enough free space on the hard disk, the repeat time will be limited to a number less than 99, and you will be able to specify a larger number when you turn the JOG dial.)

6. Press the EXECUTE/YES key.

The upper row of the display will show the time taken for the Copy & Paste operation, then "CoPY", "PAsT", then "COMPLETED!". Press the EXIT/NO key to go back to the previous screen.

Now the audio data on the Clipboard has been pasted to the specified track stating with the AUTO PUNCH IN point.

For example, executing the function with a repeat number of "rPt 03" (three times) will paste the data as shown in the diagram below.



\* To cancel the Copy & Paste operation, press the EXIT/NO key when the display blinks the "ARE YOU SURE?" message. If you wish to abort the Copy & Paste operation after you have pressed the EXECUTE/YES key, press the STOP button or the EXIT/NO key before the display show "COMPLETE!" indicating completion of the Copy & Paste operation.  
If you cancel or abort the Copy & Paste operation in these ways, no part of the copied data will be pasted. (Even if you abort an operation in progress, nothing will be pasted.)

< Note >  
After you copy & paste data onto any part of the copy source data, if you wish to redo the Copy & Paste operation, erasing the pasted part will also change the original copy source data. (Refer to page 88 of the main manual for details.)  
If you wish to redo the Copy & Paste operation, do not erase the paste part, instead, be sure to undo the operation.

### Undo/Redo Copy & Paste

You can cancel the Copy & Paste operation by pressing the UNDO key. Pressing the REDO key after pressing the UNDO key will restore the data that was obtained before undoing the operation (that is, you can restore the status obtained after the first Copy & Paste operation). Pressing the UNDO/REDO keys will cause the display to show "COMPLETED", then return to the previous screen.

#### < Note >

The Undo/Redo functions are effective only while the DMT-8 is stopped. They are not available in any other mode.

#### < Note >

The Undo/Redo functions are not effective in the following situations;

- [1] After new recording
- [2] After new editing (such as copy & paste, move & paste, erase, and cut)
- [3] When the Auto Punch In point is passed during playback or recording with Auto Punch In mode set to ON
- [4] When you turn the power off and on

## Using the Move & Paste function

#### < Note >

You need enough unrecorded spectre on the hard disk to execute the Move & Paste operation or the Copy & Paste operation. (The alarm message "Over timE" and the solution of the Copy & Paste operation will apply to the Move & Paste operation.)

#### < Note >

The same restriction as the Copy & Paste function applies to the Move & Paste operation between the different tracks. (Refer to the section explaining the Copy & Paste function for more details.)

As in the Copy & Paste operation, copy the data into the Clipboard, and store the paste start point (Auto Punch In point). (Refer to the Copy & Paste section for a detailed procedure.)

\* The steps up to this point are exactly the same as for Copy & Paste operation.

### Executing the Move & Paste operation

1. Press the PASTE key.

Pressing the key repeatedly will change the display indication in the following order; "coPy PAsT" ->-> (after one second) ->-> "rPt 01 PAsT ARE YOU SURE?" (ready for the Copy & Paste operation), alternatively "movE PAsT" ->-> (after one second) ->-> "rPt 01 movE ARE YOU SURE?" (ready for the Move & Paste operation). In this procedure, select "rPt 01 movE ARE YOU SURE?" to execute the Move & Paste operation. The copy source track number will light up, and "01" will blink, indicating that the number of repeats to paste is "one".

2. Specify the move destination track and the number of repeats to paste.

\* Specifying the move & paste designation track;  
Select the destination track using the RECORD TRACK select key. (You do not need to specify the track if you are going to move & paste data in the copy source track.)

\* Specifying the number of repeats to move & paste;  
Turn the JOG dial to change the blinking number "01" to any value between 01 and 99. (if there is not enough free space on the hard disk, the repeat time will be limited to a number less than 99, and you will be unable to specify a large number when you turn the JOG dial.)

3. Press the EXECUTE/YES key.

The upper row of the display will show the time taken for the Move & Paste operation, then "MoVE", "PAsT", then "COMPLETED!", Press the EXIT/NO key to go back to the previous screen.

Now the audio data on the Clipboard has been pasted to the specified track starting with the Auto Punch In point.

Unlike the Copy & Paste operation, executing the Move & Paste function will erase the original data and the data on the Clipboard.

For example, executing the function with a repeat number of "rPt 03" (three times) will paste the data as shown in the diagram below.

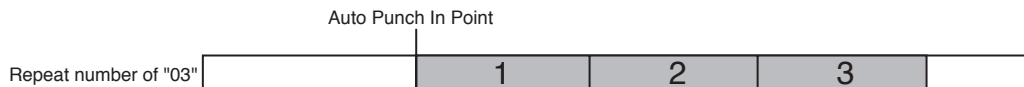

\* To cancel the Move & Paste operation, press the EXIT/NO key when the display shows blinks the "ARE YOU SURE?" message. If you wish to abort the paste operation after you have pressed the EXECUTE/YES key, press the STOP button or the EXIT/NO key before the display shows "COMPLETED!", indicating the completion of the paste operation. If you cancel or abort the press operation in these ways, no part of the copied data will be pasted at all. (Even if you abort an operation in progress, nothing will be pasted.)

< Note >

The data on the Clipboard will be cleared after the Move & Paste function is executed. Therefore, you cannot paste the same data again.

**Undo;/Reedo of the Mode & Paste function**

*You can use the Undo/Redo functions for the Move & Paste operation in the same way as for the Copy & Paste operation.*

**< Note >**

*The Undo/Redo functions are effective only while the DMT-8 is stopped. They are not available in any other mode.*

**< Note >**

*The Undo/Redo functions are not effective in the following situations;*

*[1] After new recording*

*[2] After new editing (such as copy & paste, move & paste, erase, and cut)*

*[3] When the Auto Punch In point is passed during playback or recording with Auto Punch In mode set to ON*

*[4] When you turn the power off and on*

## **Notes on Cut/Erase**

*Follow the procedure in the main manual for the Cut/Erase function.*

*Also, follow the notes below:*

**< Note >**

*The Cut/Erase function is effective only for the currently-selected Program. Be sure to check the Program number before executing this function.*

**< Note >**

*If you try to cut the data for a program in its entirety by storing the ABS 0 point at the Auto Punch In point, about 100ms of data may remain at the beginning.*

*In this case, us the Erase function to erase the unnecessary part. (The Erase function can erase data that was not deleted by the Cut function.)*

### 3. Changed and Added functions in Setup mode

The following paragraphs regarding Setup mode explain changed or added functions in Version 2.0.

\* **"SAvE"** (saving data to an external DAT recorder) has been extended.

Now you can select whether you wish to save only the currently-selected Program or all the Programs (Programs 1-5).

\* **"MTC OFFSET"** (setting an MTC offset value) precision has been improved.

You can set the MTC offset value in sub-frame units.

\* **"dG in"** (selecting a digital input channel) has been added.

You can route digital signals from the DATA IN connector (16-bit, 44.1kHz, S/P DIF format) to any two tracks for digital recording.

\* **"dG out"** (selecting a digital output channel) has been added.

You can select Tracks 1-2, 3-4, 5-6, 7-8 or mixer stereo L/R outputs signals from the DATA OUT connector (16-bit, 44.1kHz, S/P DIF format).

\* **"SLAvE"** (selecting Slave mode ON/OFF) has been added.

You can operate the DMT-8 in Slave mode by sending the MTC and digital signals from the MIDI OUT connector of a master DMT-8 or D-80.

\* **"dEvicE"** (selecting a device ID) has been added.

This function allows you to set receive device number (linked to the transmit device number) used for controlling the DMT-8 via MMC (MIDI Machine Control) or FEX (Fostex System Exclusive Message).

\* **"Undo"** (selecting an effective range of the Undo function) has been added.

In addition to the Undo/Redo function for editing and for Auto Punch In/Out recording, the Undo/Redo function for direct recording (normal recording performed by pressing the REC button while holding down the PLAY button) is now available.

The Setup menu has been divided into the two categories; "Setup menu effective for each Program", and "Setup menu applied to all Programs".

○: Setup for each program

●: Effective against ALL

Indication	Function	Commonness	Default setting
"BAR"	Sets the time signature on the Tempo Map (selected from 11 signatures: 1/4 ~ 8/8).	○	001 BAR 04 04 (Signature 4/4)
"TEMPO"	Sets the tempo on the Tempo Map.	○	001 BAR 1, 120 (Tempo 120)
"CLiCk"	Turns the Metronome function on/off.	○	OFF
"LOAD"	Loads a data file saved on a DAT to the DMT-8.	○	
"SAvE"	Saves recording/setup data from the hard disk to the DAT machine.	○●(*1)	Current Program
"FORMAT"	Initializes the hard disk.	●	
"PREROLL TIME"	Sets the preroll value for the locate point.	○	00S (00 second)
"MIDI SYNC OUT"	Selects the signal output form the MIDI OUT connector.	○	CLOCK (MIDI clock)
"FRAME RATE"	Selects the frame rate for MTC output.	○	25 Frame
"MTC OFFSET"	Sets the offset value between MTC and ABS time.	○	0H: 59M: 57S: 00F: 00SF
"EnAbLE rEc"	Selects recording enable/disable.	○	ENABLE (Can record)
"dG in"	Selecting a signal input channel.	●(*2)	L • (No assign) R • (No assign)
"dG out"	Selecting a signal output channel.	●(*2)	cH St (Mixer output L/R)
"rE SoLu"	Setting Display Resolution mode ON/OFF.	●	OFF
"SLAVE"	Setting Slave mode ON/OFF.	○	OFF
"dEvicE"	Setting a device ID.	●	00 (Device No. = 00)
"undo"	Setting an effective range of the Undo function.	●	EDIT (Edit and Auto Punch)

\* 1: Only the currently-selected Program, or Programs 1 ~ 5 will be saved.

\* 2: The parameters will be set default when the power is turned off (as well as the locate memory).

\* 3: You can set the Time Base for each Program individually.

### 3-1. Saving recorded data ("SAvE")

In Version 2.0, you can select whether you wish to save the currently-selected Program, or all Programs 1-5 at once. If you save all Programs, the process duration will be four times the total length of all Program data to save them.

The following diagram shows the sequence of the Programs saved to the DAT machine.

P1 -> (10 seconds between the songs) -> P2 -> (10 seconds between the songs) -> P3 -> (10 seconds between the songs) -> P4 -> (10 seconds between the songs) -> P5

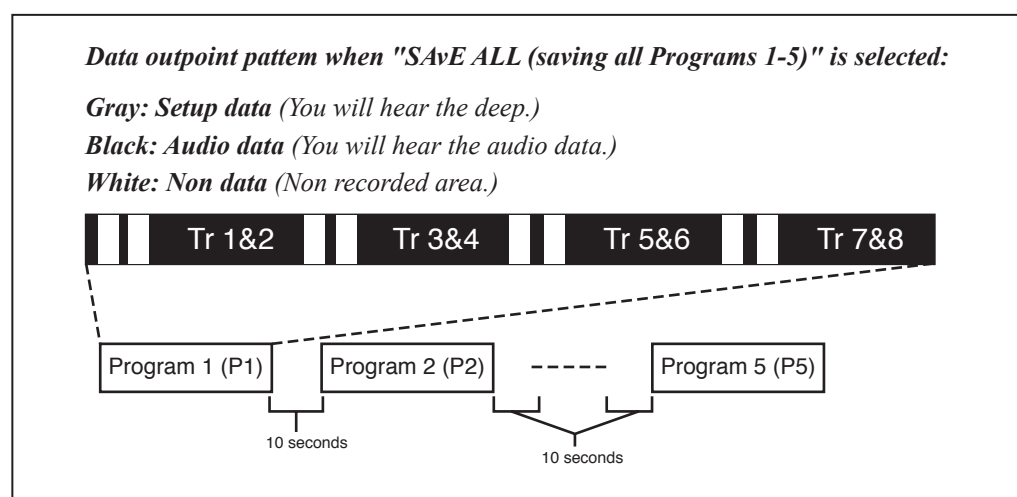

#### < CAUTION >

You can save all Programs 1-5 at once, but you cannot load them back to the DMT-8 at once. (You can load Programs one by one.) For details, refer to the "Loading from the DAT Machine (LOAD)" for details.

Saving data to DAT (SAVE)

To save a single Program, select the Program. Assume that we have selected Program 1.

1. Press the DISP SEL key to select "SETUP" and press the EXECUTE/YES key. (The "SETUP" indicator will light up.)

Turn the JOG dial to select the blinking "SAVE" option, and press the EXECUTE/YES key.

The display will change as shown below, and the Program number currently-selected ("P1" in this example) will blink. At this time, you can select whether you wish to save only this Program, or to save all Programs. Turn the JOG dial clockwise to select "ALL" or counter-clockwise to select "P1".

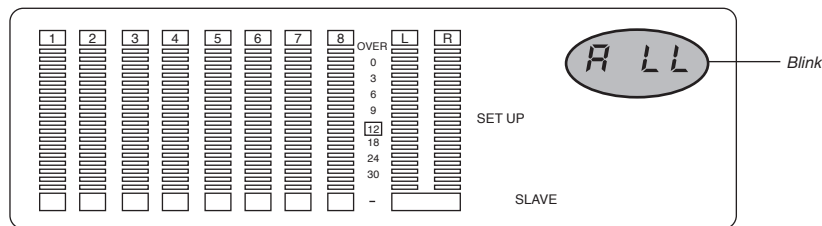
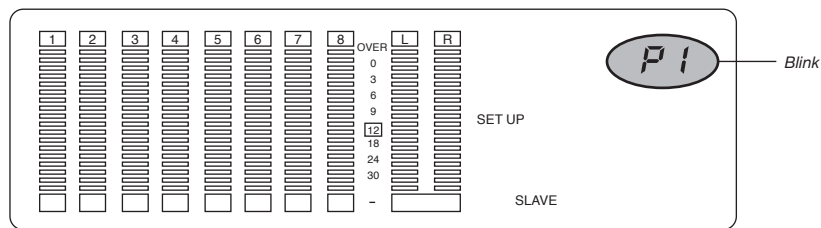

2. Press the EXECUTE/YES key again.

The display will change to something like this, and the DMT-8 will enter Save Standby mode.

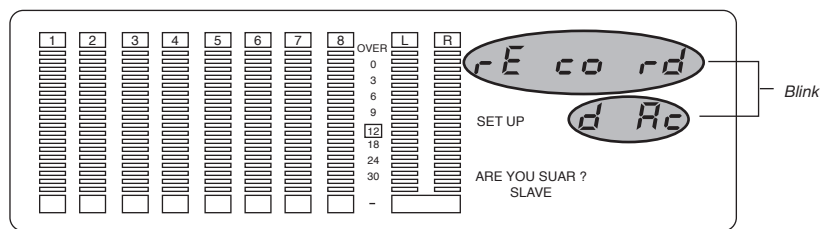

3. Start recording on the DAT machine, and press the EXECUTE/YES key on the DMT-8 again.

As soon as the saving operation starts, the display will show the time taken for the save operation and count down. (The following example shows that the saving operation will take 18 minutes and 58 seconds.)

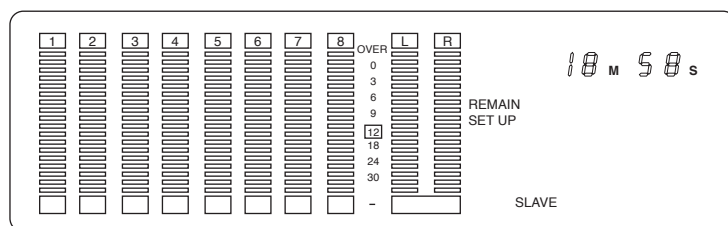



\* You process duration is about four times the length of the auto data of a Program. For example, if the Program is a song of four minutes, saving it will take about 16 minutes. The process of saving all Programs will take four times the total length of all Programs.

4. When the saving operation is completed, the display will show "COMPLETED!" and the DMT-8 will automatically quit Setup mode.

\* To abort the save operation, press the STOP button or the EXECUTE/YES key. Pressing the STOP button or the EXECUTE/YES key repeatedly will take you back to the previous stage and allow you to select other parameters or quit Setup mode.

#### Loading from the DAT machine

##### < Note >

You can save Programs 1-5 simultaneously, but you cannot load them back to the DMT-8 simultaneously. (You can load Programs one by one.) To load data, first select the Program number, then send the data of the song from the DAT, (Only one song can be loaded into each Program.)

Refer to the diagram in the previous section entitled "Data output pattern" when "SAVE ALL (saving all Programs 1-5)" is selected: " and understand the audio data output pattern before locating the beginning of the song you want to load to the DATA tape. (ex: Refer to the diagram below if you are loading Program 3 data from the DAT into Program 1.)

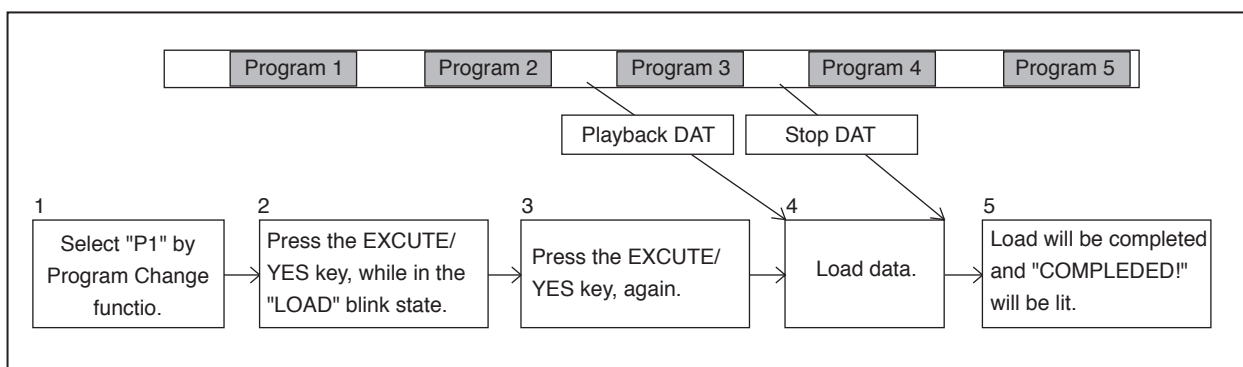

1. Press the STORE key while pressing and holding down the HOLD/> key to select a Program you wish to load.
2. Locate a position a little before the beginning of the data on the DAT tape (preroll). (If the data begins from the top of the tape, rewind the tape all the way.)
3. Press the DSP SEL key select "SETUP" and press the EXECUTE/YES key. (The "SETUP" indicator will light up). Turn the JOG dial to select the blinking "LOAD" option, and press the EXECUTE/YES key. The display will change as show below, and the DMT-8 will enter Load Standby mode.

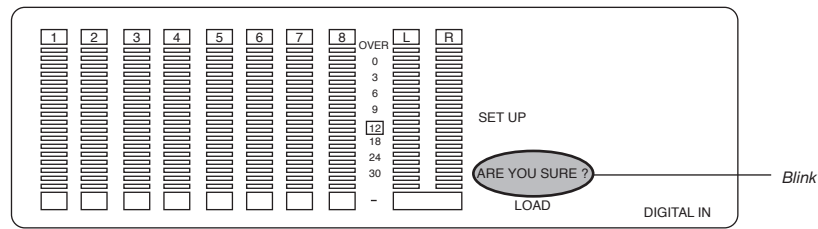

**< Note >**

If the optical cable is not connected to the DATA IN/OUT connector, or a correct signal (digital clock) is not supplied to the DMT-8, the display will blink the message "DIGITAL IN", indicating that you cannot load data. In this case, check the optical cable connection, the DATA output settings, and the content of the DAT tape.

4. Press the EXECUTE/YES key again.

The message "PLAY dAt" starts blinking on the display. Play back the DAT tape from the preroll position.

As soon as the loading operation starts, the display will show the time taken for the load operation, then count down. The data will be loaded to the currently-selected Program.

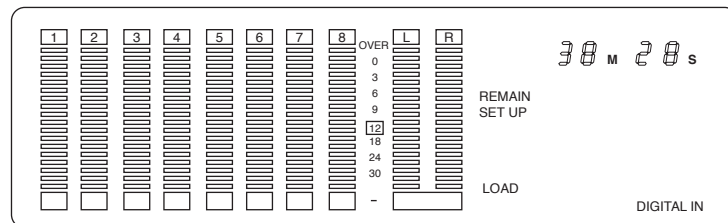
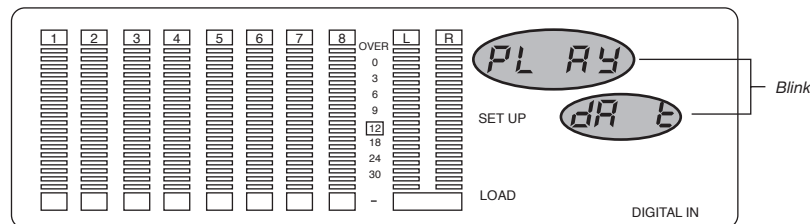

\* To abort the load operation, press the STOP button or the EXIT/NO key. When you press one of these keys, the load operation will be aborted and the DMT-8 will automatically quit Setup mode.

**< CAUTION >**

Once the loading operation starts, aborting the peroration in progress will erase all existing data in the Program, and data up until the moment of the abort will be loaded.

For example, if you have loaded two minutes of data into Program 1 (P1), which already holds a six-minute song, the existing data after two minutes will be erased. (The ABS END position of P1 is "two minutes".)

Make sure that you have selected the correct Program number before using the Load function.

5. When loading is complete, the display will show "COMPLETED!" and the DMT-8 will automatically quit Setup mode.

### 3-2. Setting the MTC offset time ("MTC OFFSET")

Available offset time range in Version 2.0 is 0H:00M:00S:00SF through 5H:59M:59S:29SF. This setting is effective only in the selected Program.

### 3-3. Setting a digital input channel ("dG in")

Using "dG in" of Setup menu, you can assign any of the analog inputs 1-8 to digital inputs L and R. This assignment will allow you to record digital data from an external digital device (such as CD, MD, etc.) to the DMT-8 through DATA IN. (You can record data directly to the hard disk, without using an A/D converter.) This setting will be shared by all Programs. Turning the power off will set this setting to "OFF".

1. Press the DISP SEL key to select "SETUP" and press the EXECUTE/YES key. (The "SETUP" indicator will light up.) Turn the JOG dial to select the blinking "dG in".

The display will change to something like this, and the current value will appear. (The default setting is "L -", "R -", indicating that both are off.)

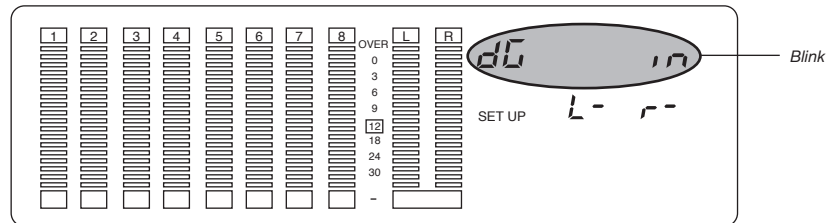

2. Press the EXECUTE/YES key again.

Letter "L -" on the display will blink, and you can now edit the value.

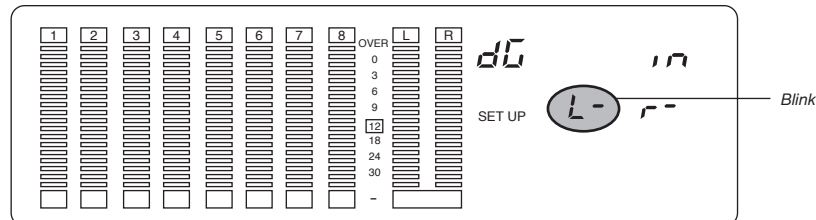

3. Use the SHUTTLE dial to select blinking "L -" or "R -", and turn the JOG dial to input numeric data (1-8).
4. Press the EXECUTE/YES key again.  
The display in Step 1 will appear, and the setting is complete.
5. Press the STOP button or the EXIT/NO key to quit Setup mode.

#### < CAUTION >

You cannot use the tracks for analog recording iff they are assigned to digital input. Therefore, return this parameter to the "OFF" setting after digital recording is complete.

#### < Note >

If you assign the same track to both digital inputs L and R, the L channel will have priority and the R channel will automatically be "OFF".

Recording digitally from an external device

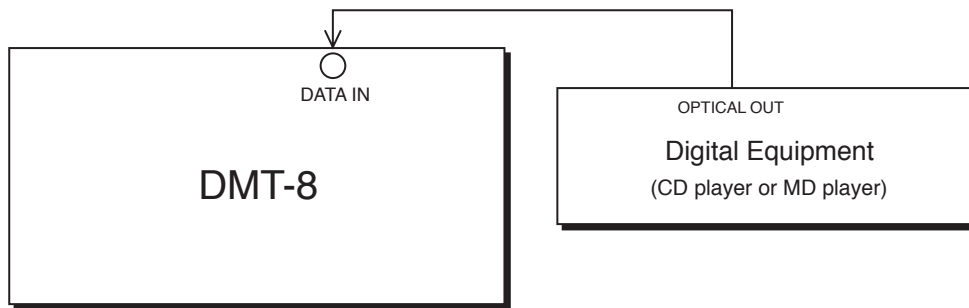

1. Connect an optical cable to the DMT-8's DATA IN and to the OPTICAL OUT connector on the external digital device (CD player or MD player). If the external digital device has only coaxial connectors for digital output, use an optical COP-1 (optical/coaxial converter).
  2. Pressing the STORE key while holding down the HOLD/> key allows you to select a recording Program.
  3. Assign a recording track in "dG in" of Setup mode on the DMT-8. If digital signal is being input correctly, the display will show the illuminated message "DIGITAL IN". If the signal input is incorrect, this message will blink.
  4. Press the RECORD TRACK select key for the track you selected in Step 3, and the display will show "READY".
  5. Confirm that "DIGITAL IN" on the display is lit, and press the RECORD button while holding down the PLAY button on the DMT-8 to start recording. You do not have to adjust the digital recording level.
  6. Start playing back data on the external digital device.
  7. When recording is complete, press the STOP button on both the DMT-8 and the digital device.
- \* Refer to next page "<Note> Important" for details.

< **WARNING** >**\* Important !\***

After digital recording is complete, or during the time when you are not performing digital recording, set the digital input L/R channels to "-" (no assing).

If the digital input channels remain assigned to the tracks and you set the tracks in recording mode (or in input monitoring mode), abnormal digital signals ("DIGITAL IN" is blinking) may cause the digital signals to from loops and oscillate internally, leading to possible damage to the external speakers.

**\* Important !\***

After completing digital recording, if you wish to continue a different digital recording session, make sure to supply correct digital signals to the DMT-8 untl a series of digital recording sessions is finished. (Do not remove the optical cable or turn the power to the external device during the session.)

When you are performing a new digital recording session (or input monitoring), abnormal digital signals ("DIGITAL IN" is blinking) may cause the digital signals to from loops and oscillate internally, leading to possible damage to the external speakers.

< **Note** >

It is prohibited by law to record and use any piece of music for which copyright is possessed by a third party for commercial purpose - such as contents, broadcasting, and sales - any purpose other than for your personal pleasure.

### 3-4. Setting a digital output channel ("dG out")

Using "dG out" of Setup menu, you can assign any of analog outputs 1-8 to digital output L or R. Select any one combination from "1-2", "3-4", "5-6", "7-8", and "s t" (DMT-8 stereo output L/R).

This assignment will allow you to record digital data from the DMT-8's DATA OUT to an external digital device (such as CD, MD, etc.)

This setting will be shared by all Programs. The dealt setting is "s t" (DMT-8 stereo output L/R). Tuning the power off will set this setting to default.

1. Press the DISP SEL key to select "SETUP" and press the EXECUTE/YES key. (The "SETUP" indicator will light up.) Turn the JOG dial to select blinking "dG out".

The display will change to something like this, and the current value will appear. (The default setting is "cH s t".)

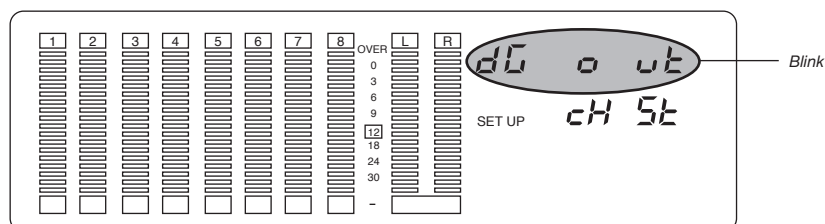

2. Press the EXECUTE/YES key again.

The letter "cH s t" on the display will blink, and you can now edit the value.

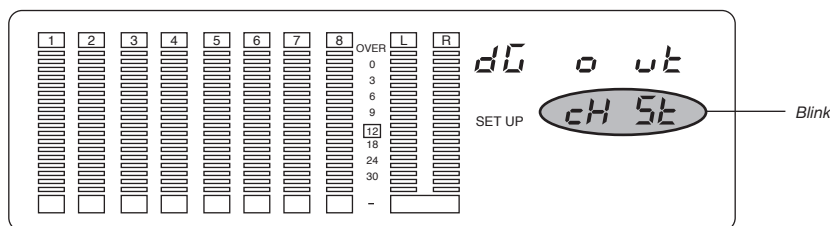

3. Use the JOG dial to select from "1-2", "3-4", "5-6", "7-8", and "s t".

4. Press the EXECUTE/YES key again.

The display in Step 1 will appear, and the setting is complete.

5. Press the STOP button or the EXIT/NO key to quit Setup mode.

Recording digitally an external device

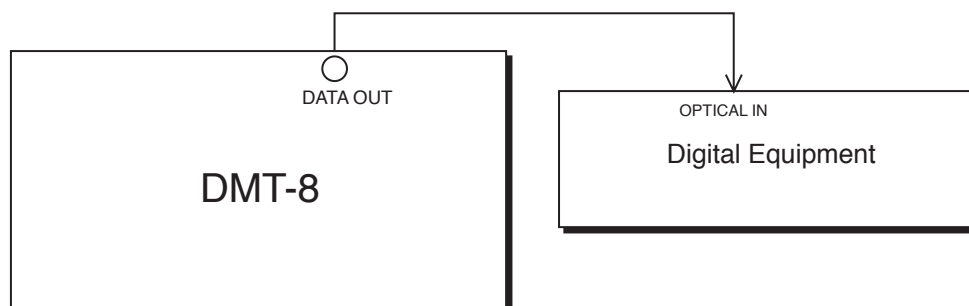

1. Connect an optical cable to the DMT-8's DATA OUT and to the OPTICAL IN connector on an external digital device (DAT or MD player).

If the external digital device has only coaxial connectors for digital input, use an optical COP-1 (optical/coaxial converter).

2. Pressing the STORE key while holding down the HOLD/> key allows you to select an output Program.

3. Assign an output track in "dG out" of Setup mode on the DMT-8.

If you select tracks "1-2", "3-4", "5-6", "7-8", the add number track will be assigned to digital output R channel.

4. Start recording on the external digital device.

5. Press the PLAY button on the DMT-8 to start playing back data.

6. When recording is completed, press the STOP button on both the DMT-8 and the digital device.

### 3-5. Setting Display Resolution mode On/Off ("rESoLu")

"rESoLu" in Setup menu allows you to turn Display Resolution mode on and off. When you are storing the In/Out points in real-time while using the "BAR/BEAT/CLK" Time Base, you can store them in steps of beats if the "rESoLu" (Display Resolution mode On/Off) in Setup mode is "ON".

When this resolution mode is "ON", the CLK value will be rounded up or off to "00" (at the beginning of the beat) as soon as you press the STORE key. This function is useful when you wish to use the Copy & Paste or Move & Paste function in setup of beats.

This setting will be shared by all Programs and maintained after you turn off the power.

\* For example, if you to store value "001 BAR", "1 BEAT", "46 CLK" as the copy start point, and "002 BAR", "4 BEAT", "51 CLK" as the end point while using the BAR/BEAT/CLK Time Base, these value will be stored as follows when they are held if Display Resolution mode has been set to on:  
The following example uses a signature of 4/4.

"001 BAR", "1 BEAT", "46 CLK" -> "001 BAR", "1 BEAT", "00 CLK" (CLK value is cut off.)

"002 BAR", "4 BEAT", "51 CLK" -> "003 BAR", "1 BEAT", "00 CLK" (CLK value is rounded up.)

1. Press the DISP SEL key to select "SETUP" and press the EXECUTE/YES key. (The "SETUP" indicator will light up.) Turn the JOG dial to select blinking "dG out".

The display will change to something similar to this, and the current value will appear. (The default setting is "oFF".)

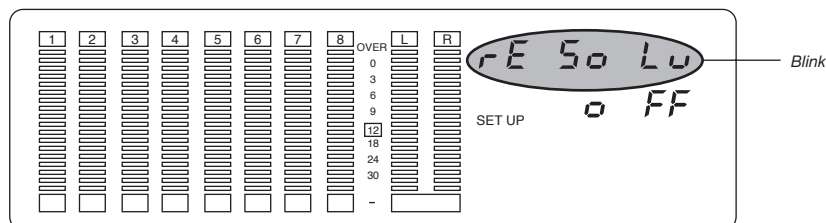

2. Press the EXECUTE/YES key again.

Letters "oFF" on the display will blink, and you can now edit the value.

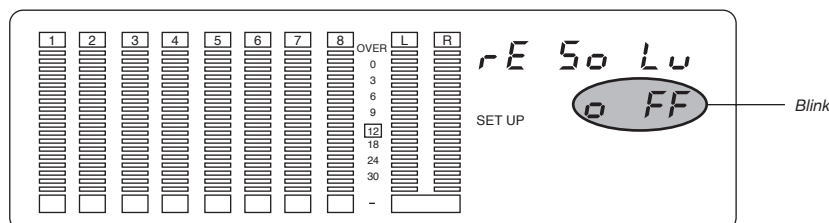

3. Use the JOG dial to select "oFF" or "on".

Turning the JOG dial counter-clockwise will select "oFF", and turning it clockwise will select "on".

4. Press the EXECUTE/YES key again.

The display in Step 1 will appear, and the setting is complete.

5. Press the STOP button or the EXIT/NO key to quit Setup mode.

### 3-6. Setting Slave mode On/Off ("SLAvE")

The "SLAvE" option in the Setup menu allows you to turn Slave mode on and off. When this mode is on, the DMT-8 will be able to synchronize the MTC (MIDI time code) sent from the master DMT-8 (or D-80). (Along with the MTC, the master DMT-8 (or D-80) will send digital signals to the slave DMT-8 as a reference).

This setting is effective only in the selected Program and will be maintained after you turn off the power.

1. Press the DISP SEL key to select "STUP" and press the EXECUTE/YES key. (The "SETUP" indicator will light up.) Turn the JOG dial to select blinking "SLAvE".

The display will change to something similar to this, and the current value will appear. (The default setting is "oFF".)

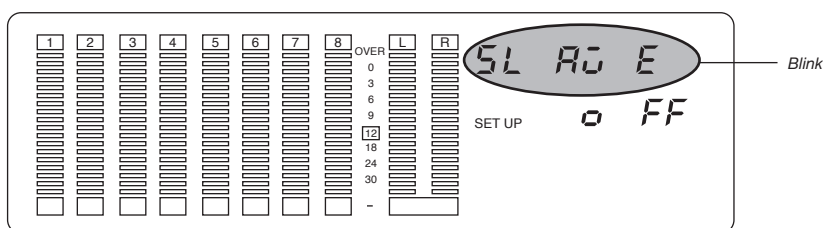

2. Press the EXECUTE/YES key again.

The letters "oFF" on the display will blink, and you can edit the value now.

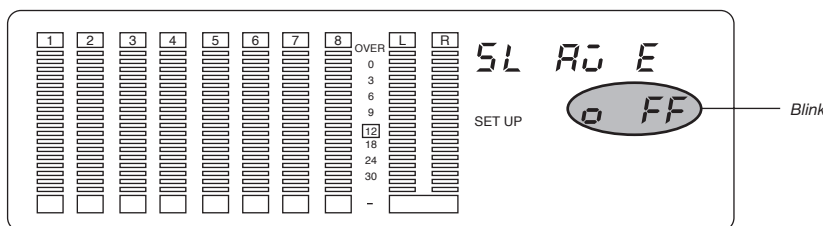

3. Use the JOG dial to select "oFF" or "on".

Turning the JOG dial counter-clockwise will select "oFF", and turning it clockwise will select "on".

4. Press the EXECUTE/YES key again.

The display in Step 1 will appear, and the setting is complete.

5. Press the STOP button or the EXIT/NO key to quit Setup mode.

#### < Note >

The DMT-8 requires an external digital as well as an external MTC for its slave operation. Therefore, connect the DATA OUT terminal off the master DMT-8 or DMT-8 Version 2.0 (or D-80) to the DATA IN terminal of the slave unit using an optical cable. (You do not need to set any other settings on the master unit, since the master unit's DATA OUT connector always outputs digital signal.)

If you have not connected the units as described above (or in the slave unit does not receive digital signals correctly for some reason), the "DIGITAL IN" indicator of the slave unit will blink, indicating an error.



Synchronizing multiple DMT-8s in Slave mode

If you connect one DMT-8 as a master with another DMT-8 as a slave, you can realize a 16-input/16-track multitracker system.

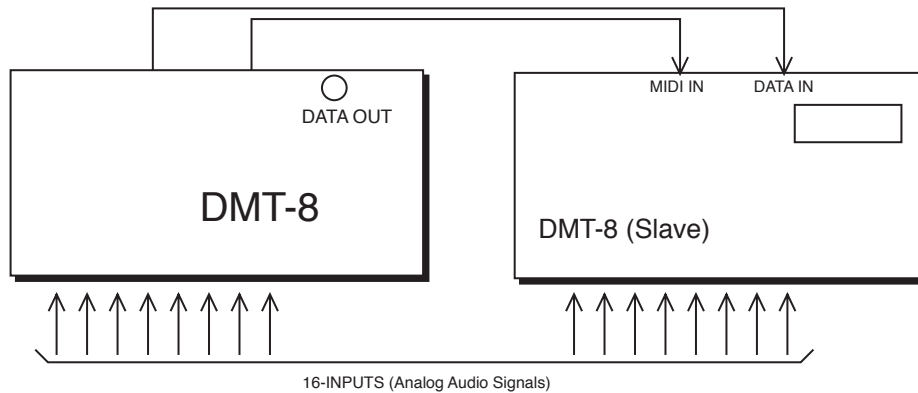

1. Connect the DATA OUT connector of the master device with the DATA IN connector of the slave device using an optical cable. Connect the MIDI OUT of the master device with the MIDI IN of the slave service using a MIDI cable.
2. Set "MIDI SYNC OUT" of Setup mode on the master device to "mtc", and set "MTC OFFSET" and "FRAME RATE" to a desired value. On the slave device, set "MTC OFFSET" and "FRAME RATE" to the same value as those of the master device.
3. Set "SLAvE" of Setup mode on the Slave DMT-8 to "ON". When "on" is selected, the PLAY LED will blink. (This means that Slave mode has been set to "on" but synchronization has not been established. When synchronizarion is estalished, the LED will light up.) After Slave mode of the DMT-8 (slave) is turned on, its "DIGITAL IN" will light up once digital signal output from the DMT-7 (master)is read correctly. (The message will blink if the signal is read incorrectly.)

**< Note >**

To operate two more DNT-8s in slave mode, use a commercially available MIDI para box (thru box), and connect the MTC output of the master DMT-8 to the MIDI IN terminal of the other two DMT-8s. Connent the DATA OUT terminal of the first slave DMT-8 to the DATA IN terminal of the second DMT-8 using an optical cable.

Checking the sync operation

1. Press the PLAY button to start playback on the master DMT-8. The slave DMT-8 will read the MTC sent from the master DMT-8 correctly, and the sync operation will start. The blinking "PLAY LED" will light up.

\* You can perform normal recording and punch in/out recording on one of the DMT-8s even if it is syncing the external MTC (and digital signals) with Slave mode "ON".  
You can also select any "MIDI SYNC OUT" setting regardless of the Slave mode on/off status.

\* The DMT-8 Recharge window is fixed at "10 frames". That is, if the digital signal sent to the slave machine is interrupted (or if you try perform a sync operation using only the MTC, without sending any digital signal), the slave DMT-8 will continue operating synchronization as long as the offset between the master and slave position is within 10 frames. However, if the offset exceeds 10 frames, the slave machine will adjust the position in relation to the master device position. (This is called a Recharge operation".) Audio output will be muted during the recharge operation.

### 3-7. Setting MIDI device ID ("dEvice")

The "dEvice" in Setup menu allows you to set the device ID for controlling the DMT-8 via MMC or Fostex System Exclusive Message sent from external sequencing soft ware. (The transmit device ID is linked to this setting.)

The range of the device ID is 00 through 99. (However, if the device ID number of the received message is "7F", the DMT-8 will follow this message regardless of the device ID setting.)

The setting will be shared by all Programs, and once you change this setting, the change will apply to all Programs. This setting is maintained after you turn off the power.

1. Press the DISP SEL key to select "SETUP" and press the EXECUTE/YES key. (The "SETUP" indicator will light up.) Turn the JOG dial to select the blinking "dEvice".

The display will change to something similar to this and the current value will appear. (The default setting is "00".)

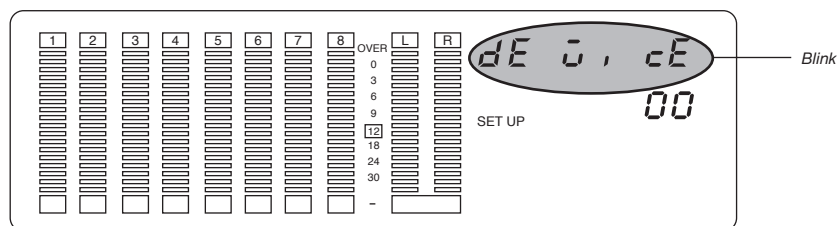

2. Press the EXECUTE/YES key again. "00" on the display will blink, and you can now edit the value.

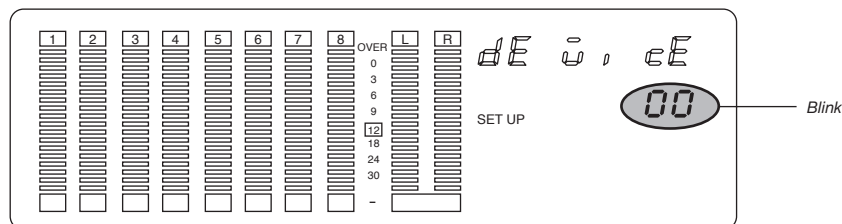

3. Use the JOG dial to set the value between 00 and 99. Turning the JOG dial counter-clockwise will decrease the value, and turning it clockwise will increase it.

4. Press the EXECUTE/YES key again.  
The display in Step 1 will appear, and the setting is complete.
5. Press the STOP button or the EXIT/NO key to quit Setup mode.

### 3-8. Setting the Undo function range ("Undo")

You can set an effective range for the Undo function in "Undo" in Setup mode.

Two modes are available for the Undo function:

"Edit" : Non-destructive mode OFF - this mode allows for undo of auto punch in/out, copy & paste, and move & paste, and "ALL". Non - destructive mode ON - this mode allows for undo of all types of recording and editing.

**< Note >**

When executing direct recording in "undo ALL" mode, you need enough free disk space to accommodate real time recording data. If you record a large amount of data in this mode, the remaining disk space may run out during your performance.

In this case, use the Undo function as soon as possible. (Once you perform any edit operation, you will not be able to use the Undo function.) To maximize the available disk space, cut an unnecessary part of another Programs, and move the ABS END point of each Program backward as much as possible.

1. Press the DISP SEL key to select "SETUP" and press the EXECUTE/YES key. (The "SETUP" indicator will light up.) Turn the JOG dial to select blinking "Undo".  
The display will change to something similar to this, and the current value will appear. (The detail setting is "Edit".)

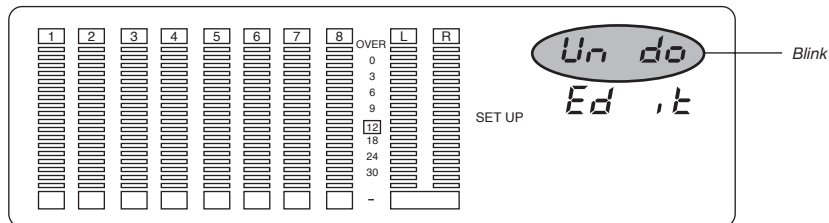

2. Press the EXECUTE/YES key again.  
The letters "Edit" on the display will blink, and you can edit the value now.

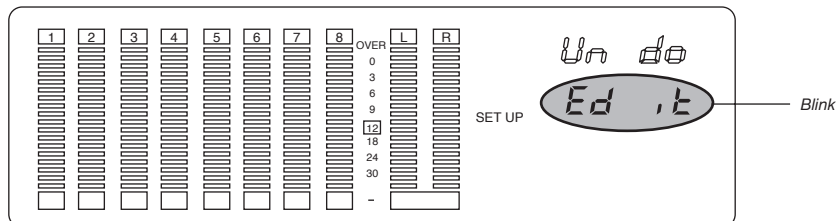

- Use the JOG dial to select "Edit" or "ALL".

Turning the JOG dial counter-clockwise will select "Edit", and turning clockwise will select "ALL".

"Edit" (Non-destructive mode off)	The Undo function is effective only on the Auto Punch In/Out, Paste, Erase, and Cut functions.
"ALL" (Non-destructive mode on)	The Undo function is effective on normal recording as well as the Auto Punch In/Out, Paste, Erase, and Cut functions.

- Press the EXECUTE/YES key again.

The display in Step 1 will appear, and the setting is complete.

- Press the STOP button or the EXIT/NO key to quit Setup mode.

#### 4. Compatible with Fostex System Exclusive Message

As explained in the protocol section at the end of the manual, the DMT-8 Version 2.0 is compatible with "FEX" (Fostex System Exclusive Message), which allows for high-quality control and communications via MIDI. Refer to the protocol section for more details.

#### 5. A new output function that merges MMC/FEX (Fostex System Exclusive Message) and MTC internally.

The DMT-8 Version 2.0 will automatically and internally merge and send the MMC and FEX from the MIDI IN connector to the MIDI OUT connector. This function is useful when you wish to control the sync operation of two DMT-8s from a computer.

In the example below, the master DMT-8 will merge the self-generated MTC (that is sent to the slave DMT-8) with the MMC and FEX that are output from the computer (along with the MMC/FEX reply message). This merged signal is sent to the MIDI OUT connector, then to the slave unit.

You can also select any "MIDI SYNC OUT" setting regardless of the Slave mode On/Off status. In this example, the DMT-8 slave unit will output the sync signal selected by its "MIDI SYNC OUT" setting via the MIDI OUT connector to the computer.

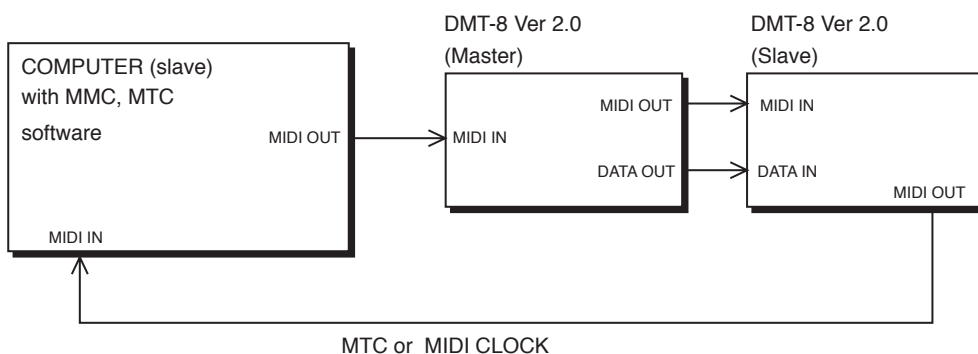

*6. The maximum number of Tempo Map change points is now 64 for a time signature, and 64 for a tempo.*

*The older version had a maximum number of Tempo map change points of 16 (time signature) / 32 (tempo). This number has been increased in Version 2.0.*

*Thus is very useful when you wish to create a song that includes a lot of time signature changes or frequent ritardandos or tempo. (You can set the number of change points for each Program individually.)*

*The setting method has not changed.*

## Fostex MIDI System Exclusive Message Format for D-80/DMT-8 ver 2.0

**< Note >**

Following Protocol is effective only in equipment which will reply by -  
 Identity Reply=F0 7E<channel> 06 02 51 01 00 0A 00 01 00 7F 7F F7 (D-80)  
 Identity Reply=F0 7E<Channel>06 02 51 01 00 09 00 02 00 7F F7 (DMT-8 ver 2.0)  
 against the Inquiry Message=F0 7E<channel>06 01

### Fostex System Exclusive Message

General Structure=F0 51<device id><sub id 1><data>F7

\* Numbers are all expressed in hexadecimal units.

Table: <sub id 1> (<data>)

Command or Model Set Controller to D-80/DMT-8 ver 2.0	Acknowledge or Status D-80/DMT-8 ver 2.0 to Controller
Loop on/off      12 22 (<on/off>)	
Post locate      12 28 (<post locate moded>)	
Auto rec          12 2D (<on/off>)	32 2D (<edit message>)
Lock enable      12 41 (<lock enable>)	
Copy clip        12 45 (<count><mmc track>)	32 45 (<edit message>)
Copy paste       12 46 (<count=01><repeat count>) or 12 46 (<count><repeat count><mmc track>)	32 46 (<edit message>)
Erase            12 47 (<count><mmc track>)	32 47 (<edit message>)
Cut               12 48	32 48 (<edit message>)
Clipboard play   12 49	32 49 (<edit message><mmc track>)
Undo             12 4A	32 4A (<edit message>)
Redo             12 4B	32 4B (<edit message>)
Nondes. mode    12 4C (on/off) * Refer to Note 1.	
Move clip        12 4D (<count><mmc track>)	32 4D (<edit message>)
Move paste       12 4E (<count=01><repeat count>) or 12 4e (<count><repeat count><mmc track>)	32 4E (<edit message>)
Digital in ch.   13 41 (<channel><channel>)	
Digital out ch.   13 42 (<channel><channel>) *refer to note 2.	
Program change   13 43 (<program>)	
Click on/off     13 44 (on/off)	

## Status Request

Status request command Controller to D-80/DMT-8 ver 2.0		Status reply D-80/DMT-8 ver 2.0 to controller
Loop op. status	22 21	32 21 (<Loop op. mode = 12>)
Loop status	22 22	32 22 (<on/off>)
Post locate status	22 28	32 28 (<post locate status>)
Auto rec status	22 2D	32 2D (<edit message>)
Lock status	22 41	32 41 (<lock status>)
Copy clip status	22 45	32 45 (<edit message=01 or =14>)
Copy paste status	22 46	32 46 (<edit message=02><mmc time>) or 32 46 (<edit message=00>)
Erase status	22 47	32 47 (<edit message=02><mmc time>) or 32 47 (<edit message=00>)
Nondes. mode	22 4C	32 4C (<on/off>)
Move clip status	22 4D	32 4D (<edit message=01 or =14>)
Nove paste status	22 4E	32 4E (<edit message=02><mmc time>) or 32 4E (<edit message=00>)
Digital in ch. st.	23 41	32 41 (<channel><channel>)
Digital out ch. st.	23 42	33 42 (<channel><channel>)
Program status	23 43	33 43 (<program>)
Click status	23 44	33 44 (<on/off>)
Level status	23 45	33 45 (<count=08><level data>)

### < Note 1 >

*Nondes. mode:*

Abbreviation for "non destructive recording mode". When this mode is ON, not only "takes" made by various sound editing or AUTO PUNCH IN/OUT but "takes" recorded by simultaneous pressing of the PLAY and RECORD buttons (direct recording) will always be possible to UNDO (However, free disc memory space equivalent to the recording length will always be required). This is the same function of switching between "undo:ALL (Nondes.momde:on) <--> Edit (Nomdes. mode: off)" in the setup menu on the main unit.

### < Note 2 >

There is a limitation on specifying the <channel><channel> setting. For details, refer to "Explanation on Command/Mode Set" mentioned in later pages.

### EXPLANATION ON READ/WRITE INTO THE VARIOUS EDIT POINT MEMORY

The MMC response/information field "GP0~GP6" are allotted in the edit point memories (clipboard in, clipboard out, auto punch in, auto ouch out memory, etc.) which is necessary at editing. Therefore, at registering and readout of the edit point memory, the "WRITE (40)" command and the "READ (42)" command of MMC must be used. Relationship between the Edit point memory of D-80/DMT-8 ver2.0 and GP0~GP6 are shown below:

<Response/Information Field>

08 GP0 : locate memory

0A GP2 : clipboard out memory

0C GP4 : auto punch in memory

0E GP6 : end memory

09 GP1 : clipboard in memory

0B GP3 : start memory

0D GP5 : auto punch out memory

0F GP7 : reserved

## Data Type

<loop op.mode>	12=stop Indicates the next operating mode following locating to the start point (GP3) upon arriving at the end point (GP6) by the play mode. In D-80/DMT-8 ver2.0, 12=stop only is effective.
<post locate mode>	12=stop 15=play Specifies operating mode in which D-80/DMT-8 ver2.0 should enter upon completing the locate operation. Corresponds to the setting of AUTO PLAY ON ("15"/OFF("12") on the main unit.
<count>	01~7F Specifies succeeding data byte numbers.
<mmc track>	Complies to the MMC (MIDI MACHIN CONTROL) standard track bit map. In D-80/DDMT-8 ver2.0, you always need to specify two byte combinations of "r0" and "r1."
<edit message>	00 = no message 01 = completed (completion flag) 02 = active (execution flag) 02<mmc time> = Indicates unprocessed time by active (execution flag) and <mmc time>. 02<count><mmc track> = Indicates source track by active (execution flag) and <mmc track>. Used for clipboard play. 03 = cancel (execution stop) 05 = Indicates rehearsal (rehearsal mode of auto rec). Possible of undo. 06 = Indicates take (take mode of auto rec). Possible of undo. 10 = over value error 10<mmc time> = Capacity shortage time is indicated by over value error (error by capacity shortage) and <mmc time>. In copy paste, it indicates capacity shortage time required for a minimum one time paste. 11 = Indicates in point error (incorrect in point). 12 = Indicates out point error (incorrect out point). 14 = Indicates void data (data necessary for paste does not exist). 18 = Indicates track select error (track necessary to execute copy/move) or erase/cut is not correct setup). 19<repeat count> = Indicates repeat number error and repeat number executable by< repeat count>. 1A = Indicates disable rec (record disable mode). 25 = Indicates can undo rehearsal (rehearsal mode of auto rec). Impossible to undo. 26 = Indicates can't undo take (take mode of auto rec). Impossible to undo. 71 = Indicates on. 72 = Indicates off.
<mmc time>	hr mn sc fr {ff/st} complies to the MMC standard time code.
<on/off>	70 = default 71 = on 72 = off
<repeat count>	01 ~ 7F Especially when executing commands such as paste, the number of pasting times to be continuously repeated following the auto punch in point is specified.
<channel>	00 ~ 08 Selects tracks 1 ~ 8 of the recorder section. "00" means that no setup (default setup) is made.
<lock enable>	00 = lock disable, chase disable 01 = lock enable, chase enable Corresponds to SLAVE ON ("01"/OFF ("00") in the main unit.
<lock status>	00 = lock disable, chase disable 01 = lock enable (unlocked), chase enable (unlocked) 11 = lock enable (locked), chase enable (locked)
<program>	01 ~ 7F Indicates program numbers (P1 ~ P5) on the main unit. However, D-80/DMT-8 can specify only 01 (corresponds to P1) - 05 (corresponds to P5).
<level data>	t1, t2 ..... tn n: Indicates the track number. tn: Indicates absolute 8 bits of the Auto 16 bit data (Range: 00~7F).



## Explanation on the Command/Mode Set

### 12 22 (<on/off>): loop on/off command

The command for setting the "loop mode on/off" (=ON/OFF of AUTO RTN) of D-80/DMT-8 ver2.0. Default figure of the loop operation mode is "12=stop" and this cannot be changed.

### 12 28 (<post locate mode>): post locate command

The command for setting the "post locate mode" (=ON/OFF of AUTO PLAY) of D-80/DMT-8 ver2.0. It will stop after locating if "post locate mode=12." It will enter play after locating if "post locate mode=15."

### 12 2D (<on/off>): auto rec command

The command for setting "auto rec mode on/off" (=ON/OFF of AUTO PUNCH) of D-80/DMT-8 ver2.0. Upon receiving this command, D-80/DMT-8 ver2.0 will immediately reply the operating condition by sending "32 2D (<edit message>)".

### 12 41 (<lock enable>): lock enable command

The command for setting "slave mode on/off" (setup menu) of D-80/DMT-8 ver2.0.

### 12 45 (<count><mmc track>): copy clip command

When this command is received, D-80=DMT-8 ver2.0 will copy (multiple number of tracks can be copied simultaneously) the sound data, as data for copy paste, from the pre-registered clipboard-in point to the clipboard-out point in the track specified by <mmc track>.

With completion of copying the data into the clipboard, D-80/DMT-8 ver2.0 will immediately reply with "32 45 (<edit message=01 (completed)>)".

If copy cannot be executed due to improper figures of the pre-registered clipboard in/clipboard out points or incorrect track section, the corresponding <edit message> will be returned.

### 12 46 (<count=1><repeat count>): copy paste command

### 12 46 (<count><repeat count><mmc track>): copy paste command

When this command is received, D-80=DMT-8 ver2.0 will paste the sound data which has been copied into the clipboard, on the same track from the pre-registered auto punch in point ever, if the sound data length in the clipboard is less than 10ms, the specifying the <repeat count> will be limited to "01."

Also, by specifying <mmc track>, paste can be executed on other tracks in mono (in one track units) or stereo units (in combinations of tracks 1 & 2, 3 & 4, 5 & 6, 7 & 8).

Since time corresponding to length of the copy clipped sound data is required to complete the copy paste operation, D-80/DMT-8 ver2.0 immediately replies with "32 46 (<edit message=02 (active)>)" after receiving the command.

Successively upon completing the paste operation, "323 46 (<edit message=01 (completed)> " is transmitted.

If paste cannot be executed due to improper figures of the pre-registered auto punch in point, insufficient disc capacity, no sound data in the clipboard, etc., the corresponding <editmessage> will be replied.

### 12 47 (<count><mmc track>): erase command

When this command is received, D-80=DMT-8 ver2.0 will erase the data (writes in "0" data) in the section from the pre-registered auto punch in point through auto punch out point in the track specified by <mmc track>. Since time corresponding to length of the erase section is required to complete the erase operation, D-80/DMT-8 ver2.0 will immediately reply by "32 47 (<edit message=02 (active)>)" after receiving the command.

After the completion of erase operation, "32 47 (<edit message=01 (completed)>)" will be transmitted.

If erase cannot be executed due to improper figures of the pre-registered auto punch in point/auuto punch out point, incorrect track section, etc., the corresponding edit message> will be replied.

#### 12 48: cut

When this command is received, D-80/DMT-8 ver2.0 will cut whole the section following the pre-recorded auto punch in point under the assumption that whole the tracks are nonrecorded section, With completion of the cut operation, this equipment will immediately reply with "32 48 (<edit message=01 (completed)>). "If cut is unexecutable due to improper figure of the pre-registered auto punch in point, the corresponding <edit message> will be replied.

#### 12 49: clipboard play

When this command is received, D-80/DMT-8 ver2.0 will playback once from the head of the sound data copied in the clipboard by the copy clip and move clip commands.

Immediately after receiving the command, D-80/DMT-8 ver2.0 will reply with "32 49 (<edit message=02 (active)><mmc track>)." The sound data track number is indicated by (mmc track>.

Upon completion of playback, "32 49 (<edit message=01 (completed) is sent and clipboard play is ended. If there is no sound data in the clipboard, "32 49 (<edit message=14(void data)>)" will be sent and clipboard play operation will be interrupted.

#### 12 4A: undo

Upon receiving this command, D-80/DMT-8 ver2.0 will revert to the condition prior to editing copy paste, erase, move paste, cut redo operation. When completion of undo operation, D-80/DMT-8 ver2.0 will reply with "32 4A (<edit message=01 (completed)>)." If D-80/DMT-8 ver2.0 is not possible to undo, "32 4A (<edit message=00 (no message)>)" will be replied.

#### 12 4B: redo

When this command is received, D-80/DMT-8 ver2.0 will return to the condition prior to undo operation.

With completion of redo operation, D-80/DMT-8 ver2.0 will reply with "32 4B (<edit message=01 (completed)>).

If D-80/DMT-8 ver2.0 is not possible to redo, "32 4B (<edit message=00 (no message)>)" will be replied.

#### 12 4C: (<on/off>) : nondes.mode

The command for setting on/off of non destructive moded on D-80/DMT-8 ver2.0.

If <on/off> is set to "on," recording mode of D-80/DMT-8 ver2.0 will enter the non destructive mode, and if "off," in the destructive mode.

#### ※Nondes.mode:

Abbreviation for "non destructive recording mode". When this mode is ON, not only "takes" made by various sound editing or AUTO PUNCH IN/OUT but "takes" recorded by simultaneous pressing of the PLAY and RECORD buttons (direct recording) will always be possible to UNDO (However, free disc memory space equivalent to the recording length will always be required). This is the same function of switching between "undo: ALL (Nondes. mode: on)<-- --> Edit (Nondes. mode: off)" in the setup menu on main unit.

**12 4D (<count><mmc track>): move clip command**

*When this command is received, D-80/DMT-8 ver2.0 will copy (multiple tracks can be copied simultaneously) the sound data from the pre-registered clipboard in point to the clipboard out point, as data for move paste operation.*

*With completion copying the data into the clipboard, D-80/DMT-8 ver2.0 will immediately reply with "32 4D (<edit message=01 (completed)>)."*

*If copy cannot be executed by the reason of pre-registered improper clipboard in/clipboard out point figures or incorrect track section etc., the corresponding <edit message> will be replied.*

**12 4E(<count=1><repeat count>): move paste command**

**12 4E (<count><repeat count><mmc track>): move paste command**

*When this command is received, D-80/DMT-8 ver2.0 will paste the sound data which have been move clipped in the clipboard, for the number of times specified by <repeat count> on the same track from the pre-registered auto punch in point as the starting point.*

*At the same time, the move clipped original sound data will be erased (data "0" is written in). However, when sound data length in the clipboard is less than 10ms, specifying the <repeat count> will be limited to "01."*

*Also, by specifying the <mmc track> paste operation can be executed on other tracks in mono (one track unit) or stereo units (tracks 1 & 2, 3 & 4, 5 & 6, 7 & 8).*

*Since time corresponding to length of the move clipped sound data is required to complete the move paste operation, D-80/DMT-8 ver2.0 will immediately reply with "32 4E (<edit message=02 (active)>)" after receiving the command.*

*Following completion of the move paste operation, "32 4E (<edit message = 01 (completed)>)" will be sent.*

*If paste cannot be executed due to improper figures of the previously registered auto punch in point, insufficient disc capacity, no sound data is in the clipboard, etc., the corresponding <edit message> will be replied.*

**13 41 (<channel><channel>): digital in ch. select command**

*The command assigning the digital audio signal (S/P DIF) input from the D-80/DMT-8 ver2.0 DATA IN connector to the track specified by <channel>. The digital audio signal L channel assignment point is specified by the first <channel> and the R channel assignment point by the second <channel> in the command. If the same figure is specified for both <channels>, L channel will have priority and R channel will be "-" (invalid).*

**13 41 (<channel><channel>): digital out ch. select command**

*This command selects the source track for the digital audio signal (S/P DIF) output from the D-80/DMT-8 ver2.0 DATA OUT connector.*

*Normally, the track specified by the first <channel> will be the digital audio signal L channel data, and the track specified by the second <channel> will be the digital audio signal R channel data. In this equipment, the five types - (<01><02>), (<03><04>), (<05><06>), (<07><08>) and (<00><00>) - can only be set up. Also, when (<00><00>) is specified, default (L:-, R-, No Assign) will be set up in D-80, and (L:L, R:R) will be set up in DMT-8 ver2.0. Thus the mixer section stereo bus output will be assigned on DMT-8 ver2.0.*

**13 43 (<program>): program change command**

*The command for PROGRAM CHANGE of D-80/DMT-8 ver2.0*

*The present program number can be changed to the figure indicated by <program>.*

**13 44 (<on/off>): click on/off command**

*The command for setting the metronome on/off of D-80/DMT-8 ver2.0.*

*When ON is set, the metronome signal will be fed to the track 8 output (analog output only) of D-80/DMT-8 ver2.0.*

## The Status Request Command

**22 21: loop operation status request**

*The command inquiring the loop operation mode setup status.*

*D-80/DMT-8 ver2.0 will reply with "32 21 (<loop op. moded=12>)."*

**22 22: loop on/off status request**

*The command inquiring the loop on/off (=ON/OFF of AUTO RETURN) setup status.*

*D80/DMT-8 ver20. will reply with "32 22 (<on/off>)."*

**22 28: post locate status request**

*The command inquiring the post locate mode (ON/OFF of AUTO PLAY) setup status.*

*D-80/DMT-8 ver2.0 will reply with "32 28 (<post locate mode>)."*

**22 2D: auto rec status request**

*The command inquiring the auto rec mode setup status and this is replied by "32 2D (<edit message>). Reply from D-80/DMT-8 ver2.0 against this status request will be either one of the following:*

*<edit message> =05: Possible to undo rehearsal mode.*

*=06: Possible to undo take mode.*

*=25: Impossible to undo rehearsal mode.*

*=26: Impossible to undo take mode.*

*=72: off*

**22 41: lock status request**

*The command inquiring the slave on/off setup status and the lock status.*

*D-80/DMT-8 ver2.0 will reply with "32 41 (<lock status>)."*

**22 45: copy clip status request**

*The command inquiring the clipboard condition. If there is a copy paste data in the clipboard, D-80/DMT-8 ver2.0 will reply with "32 45 (<edit message-01>).*

*If data in the clipboard is for move paste or there is no valid data in it, it will reply will "32 45 (<edit message=14 (void data)>)."*

**22 46: copy paste status request**

*The command inquiring execution status of copy paste editing.*

*When this command is received, D-80/DMT-8 ver2.0 will reply with either "32 46 (<edit message=02><mmc time>)" or "32 46 (<edit message=00>). <mmc time> indicates unprocessed time until completion.*

**22 47: erase status request**

*The command inquiring execution status of erase.*

*When this command is received, D-80/DMT-8 ver2.0 will reply by either "32 47 (<edit message=02><mmc time>)" or "32 47 (<edit message=00>)." <mmc time> indicates unprocessed time until completion.*

**22 4C: nondes.mode request**

The command inquiring the non destructive mode status.

When this command is received, D-80/DMT-8 ver2.0 will reply with "32 4C (<on/off>)."

**※Nondes.mode:**

Abbreviation for "non destructive recording mode". When this mode is ON, not only "takes" made by various sound editing or AUTO PUNCH IN/OUT but "takes recorded by simultaneous pressing of the PLAY and RECORD buttons (direct recording) will always be possible to UBDO (However, free disc memory space equivalent to the recording length will always be required), This is same function of switching between "undo:ALL (Nondes.mode:on) <- -> Edit (Nondes.mode:off)" in the setup menu the main unit.

**22 4D: move clip status request**

The command inquiring the clipboard status. If there is a move paste on the clipboard, D-80/DMT-8 ver2.0 will reply with "32 4D (<edit message=01>)." If data in the clipboard is for copy paste or there is no valid data on it, "32 4D (<edit message=14 (void data)>)" will be replied.

**22 4E: move paste status request**

The command inquiring the move paste execution status.

When this command is received, D-80/DMT-8 ver2.0 will reply with "32 4E (<edit message= 02><mmc time>)" or "32 4E (<edit message=00>)." <mmc time> indicates unprocessed time until completion.

**23 41: digital in channel status request**

The command inquiring the digital in channel setup status.

When this command is received, D-80/DMT-8 ver2.0 will reply with "33 41 (<channel><channel>)."

**23 42: digital out channel status request**

The inquiring the digital out channel setup status.

When this command is received, D-80/DMT-8 ver2.0 will reply with "33 42 (<channel><channel>)."

**23 43: program status request**

The command inquiring the presently operating program number.

When this command is received, D-80/DMT-8 ver2.0 will reply with "33 43 (<program>)."

**23 44: click on/off status request**

The command inquiring the metronome on/off status of D-80/DMT-8.

When this command is received, D-80/DMT-8 ver2.0 will reply with "33 44 (<on/off>)."

**23 45: level status request**

The command inquiring the present output level data of the 1~8 tracks. In D-80/DMT-8 ver2.0, as the level data is updated about every 40msec., inquiry in 40msec. units is effective.

When this command is received, D-80/DMT-8 ver2.0 will reply with "33 45 (<count=08><level data>)."

## Explanation on the Status Reply

**32 21 (<loop op.mode>): loop operation mode status**

*This is the reply against the "22 21" loop operation status request command.*

*<loop op.mode=12> is the only status data of D-80/DMT-8 ver2.0 and any other setting is not permissible.*

**32 22 (<on/off>): loop on/off status**

*This is the reply against "22 22" loop on/off status request.*

**32 28 (<post locate mode>): post locate mode status**

*This is the reply against "22 28" post locate status request. <post locate mode=12 or 15> is the only status data of D-80/DMT-8 ver2.0 and any other setting is not permissible.*

**32 2D (<edit message>): auto rec status**

*This is the reply against the "12 2S" auto rec command or the "22 2D" auto rec status request.*

**32 41 (<lock status>): lock status**

*This is the reply against the "22 41" lock status request.*

**32 45 (<edit message>): copy clip status**

*This is the reply against the "12 45" copy clip command or the "22 45" copy clip status request.*

**32 45 (<edit message>): copy paste status**

**32 46 (<edit message><mmc time>): copy paste status**

*This is the reply against the "12 46" copy paste command or the "22 46" copy paste status request. <mmc time> indicates the unprocessed time until completion of copy paste editing.*

**32 47 (<edit message>): erase status**

**32 47 (<edit message><mmc time>): erase status**

*This is the reply against "12 47" erase command or "22 47" erase status request.*

**32 48 (<edit message>): cut status**

*This is the reply against the "12 48" cut command.*

**32 49 (<edit message><mmc track>): clipboard play status**

*This is the reply against the "12 49" clipboard play command. If there is no sound data in the clipboard, "32 49" (<edit message=14 (void data)>)" will be replied. <mmc track> indicates the sound data track number.*

**32 4A (<edit message>): undo status**

*This is the reply against the "12 4A" undo command. Either <edit message=01 (completed) or <edit message=00 (no message)> will be replied.*

**32 4B (<edit message>): redo status**

*This is the reply against the "12 4B" redo command. Either <edit message=01 (completed)> or <edit message=00 (no message)> will be replied.*

**32 4C (<on/off>): nondes.mode status**

*This is the reply against the "22 4C" nondes.mode status request.*

**32 4D (<edit message>): move clip status**

*This is the reply against the "12 4D" move clip command or "22 4D" mode clip status request.*

**32 4E (<edit message>): move paste status**

**32 4E (<edit message><mmc time>): move paste status**

*The reply against the "12 4E" move paste command or the "22 4E" move paste status request.*

*<mmc time> indicates the unprocessed time until completion of move paste editing.*

**32 41 (<channel><channel>): digital in channel status**

*This is the reply against the "23 41" digital in ch.st. request.*

*The first <channel> indicates the track number to which the L channel digital audio signal from the DATA IN connector is assigned and the second <channel> indicates the assigned track number for the R channel.*

**32 42 (<channel><channel>): digital out channel status**

*This is the reply against the "23 42" digital out ch.st. request.*

*It indicates that the track indicated by the first <channel> in the command is assigned to the L channel output of the digital auto signal output from DATA OUT, and the track specified by the second <channel> is assigned to the R channel output.*

**32 43 (<program>): program status**

*This is the reply against the "23 43" program status request.*

*<program> indicates the presently operating program number.*

**33 44 (<on/off>): click status**

*This is the reply against the "23 44" click status request.*

*It indicates the on/off setting of the metronome function.*

**33 45 (<count=08><level data>): level status**

*This is the reply against the "23 45" level status request and indicates the present track 1~8 output level data.*

*In D-80/DMT-8 ver2.0, as level data is updated 40msec., it will be effective if inquiry is made in 40msec. units.*

**FOStex**<sup>®</sup>

**FOSTEX COMPANY**

3-2-35 Musashino, Akishima, Tokyo, Japan 196-0021

© PRINTED IN JAPAN MAR. 1996 8288 377 100 FX