

Owner's Manual
Digital Master Recorder
Model **D-25**

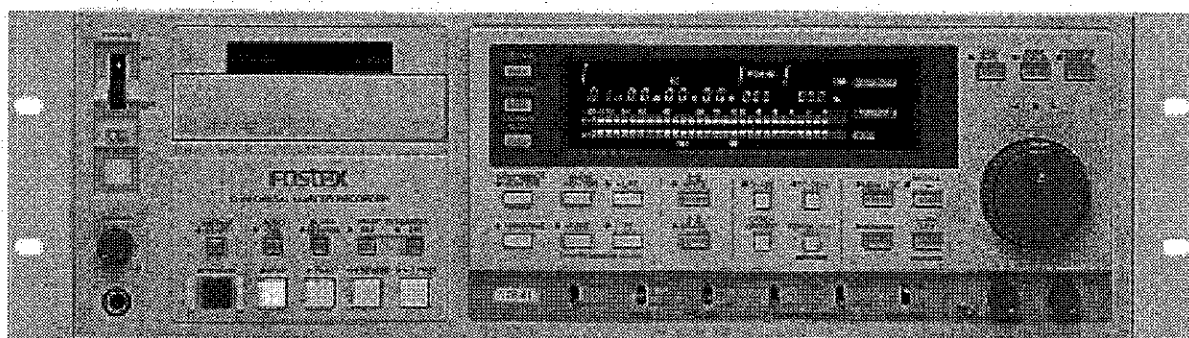

Fostex[®]

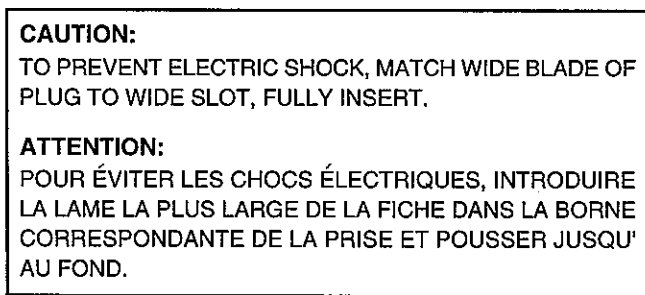
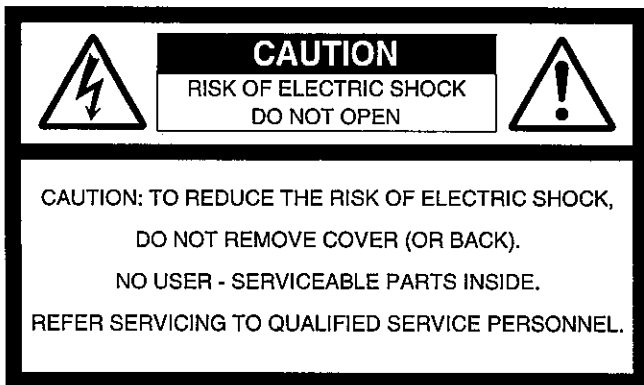

The lightning flash with arrowhead symbol, within an equilateral triangle, is intended to alert the user to the presence of uninsulated "dangerous voltage" within the product's enclosure that may be of sufficient magnitude to constitute a risk of electric shock to persons.



The exclamation point within an equilateral triangle is intended to alert the user to the presence of important operating and maintenance (servicing) instructions in the literature accompanying the appliance.

"WARNING"

"TO REDUCE THE RISK OF FIRE OR ELECTRIC SHOCK, DO NOT EXPOSE THIS APPLIANCE TO RAIN OR MOISTURE."

SAFETY INSTRUCTIONS

1. Read Instructions - All the safety and operating instructions should be read before the appliance is operated.
2. Retain Instructions - The safety and operating instructions should be retained for future reference.
3. Heed Warnings - All warnings on the appliance and in the operating instructions should be adhered to.
4. Follow Instructions - All operating and use instructions should be followed.
5. Water and Moisture - The appliance should not be used near water - for example, near a bathtub, washbowl, kitchen sink, laundry tub, in a wet basement, or near a swimming pool, and the like.
6. Carts and Stands - The appliance should be used only with a cart or stand that is recommended by the manufacturer.



An appliance and cart combination should be moved with care. Quick stops, excessive force, and uneven surfaces may cause the appliance and cart combination to overturn.

7. Wall or Ceiling Mounting - The appliance should be mounted to a wall or ceiling only as recommended by the manufacturer.
8. Ventilation - The appliance should be situated so that its location or position does not interfere with its proper ventilation. For example, the appliance should not be situated on a bed, sofa, rug, or similar surface that may block the ventilation openings; or, placed in a built-in installation, such as a bookcase or cabinet that may impede the flow of air through the ventilation openings.

9. Heat - The appliance should be situated away from heat sources such as radiators, heat registers, stoves, or other appliances (including amplifiers) that produce heat.
10. Power Sources - The appliance should be connected to a power supply only of the type described in the operating instructions or as marked on the appliance.
11. Grounding or Polarization - The precautions that should be taken so that the grounding or polarization means of an appliance is not defeated.
12. Power Cord Protection - Power supply cords should be routed so that they are not likely to be walked on or pinched by items placed upon or against them, paying particular attention to cords at plugs, convenience receptacles, and the point where they exit from the appliance.
13. Cleaning - The appliance should be cleaned only as recommended by the manufacturer.
14. Nonuse Periods - The power cord of the appliance should be unplugged from the outlet when left unused for a long period of time.
15. Object and Liquid Entry - Care should be taken so that objects do not fall and liquids are not spilled into the enclosure through openings.
16. Damage Requiring Service - The appliance should be serviced by qualified service personnel when:
 - A. The power supply cord or the plug has been damaged; or
 - B. Objects have fallen, or liquid has been spilled into the appliance; or
 - C. The appliance has been exposed to rain; or
 - D. The appliance does not appear to operate normally or exhibits a marked change in performance; or
 - E. The appliance has been dropped, or the enclosure damaged.
17. Servicing - The user should not attempt to service the appliance beyond that described in the operating instructions. All other servicing should be referred to qualified service personnel.

1st. Edition	Jan. 1995	8288 338 000
2nd. Edition	Oct. 1995	8288 338 100 (V1.05 Supplement)
3rd. Edition	Mar. 1996	8288 338 200 (V1.06 Supplement)



Additions to the D-25 Owner's Manual

Two additions to SETUP items have been added in connection with the version up (V1.06) of the D-25 software. They are:

- SETUP "410-***" 003 REC RUN (INT)
- SETUP "503-***" panel lock ON/OFF while in chase mode

The following is an addition to the Owner's Manual. Please read this together with the manual and keep it handy for future reference.

1. Additional functions added to SETUP "410-***"

"003 REC RUN (INT)" has been added to SETUP "410-***" (setup of the TC generator function). This means three items can now be selected. Because of this change, the previous "002 REC RUN" mode name has been changed to "REC RUN (REGEN)". However, there is no change to the function.

In "REC RUN (REGEN)", previously called REC RUN, time code already written on the tape when recording was begun is read and the generator time is set so that it will be continuous to this time. In the new "REC RUN (INT)" mode, time set by GEN TC PRESET will always be set in the generator before it is started. This mode is convenient for when the tape must be set to "1:00:00:00". The default setting is "001 FREE RUN".

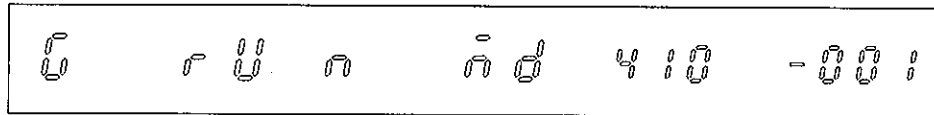

"001" (*)	FREE RUN (Content is the same as main text)
"002"	REC RUN (REGEN) (Content is the same as main text)
"003"	REC RUN (INT) (The new function in which the generator can be started from the time set by GEN TC PRESET.)

2. Additional functions added to SETUP "503-***"

ON/OFF of the main panel unit lock while the D-25 is in chase mode can be setup with this function. It can be setup by selecting from the following two items depending on the situation. The default setup is "000 (OFF)".

If the function is set to "000 (OFF)", the chase mode can be switched off with the transport control key the same as before. With the setting set to "001 (ON)", the chase mode can only be switched off with the CHASE key.

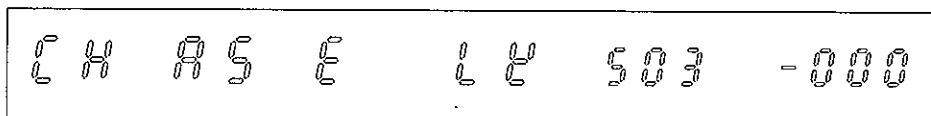

"000" (*)	OFF (The chase function can be stopped with the transport control key such as the STOP key.)
"001"	ON (CHASE cannot be stopped except with the CHASE key.)



D-25 Owner's Manual Supplement

In relation to version up (V1.05) of the D-25 software, the following item was added to the SETUP mode of the D-25. Please read this in conjunction with the main manual as only the additional functions are explained here.

Additional function

SETUP "115 -***" (ON/OFF of TAPE COUNTER mode) was added in the SETUP mode of the D-25.

By using this function, the normally shown A-TIME display can be changed to show the TAPE COUNTER display. When this mode is switched ON, the TAPE COUNTER, instead of the A-TIME display, can be shown in the display, and if a tape not recorded with a time information such as A-TIME, is played back, it will be possible to set tape to head of recording by reference to the TAPE COUNTER figure.

To activate the TAPE COUNTER mode, recall the following SETUP mode menu and set the number to "001 (ON)" (Initial setting will be "000 (OFF)."

<NOTE>

As the TAPE COUNTER of the D-25 is not the hardware counting type such as used in the Fostex Model D-10 Digital Master Recorder, counter accuracy is not high. Therefore, this TAPE COUNTER should be used only as a rough reference.



Setting number	Description
[000] (*)	OFF (A-TIME display)
[001]	ON (TAPE COUNTER display)

* denotes the default setting.

To reset the TAPE COUNTER display, first press the RECALL key, then the DISP TIME key.



Table of Contents

Introduction

Objective of this manual.....	1
Contents of this manual.....	2

Chapter 1 Outline and Outstanding features

1-1. General outline.....	1-1
1-2. Main Features of the D-25.....	1-1

Chapter 2 Notes prior to operation

2-1. Notes on operation.....	2-1
2-1-1. Precaution at Installation.....	2-1
2-1-2. Precaution on Dewing.....	2-1
2-1-3. Precautions on Safety.....	2-1
2-2. DAT.....	2-2
2-2-1. DAT Specifications.....	2-2
2-2-2. Four Head System and Simultaneous Playback Monitor.....	2-2
2-2-3. Track Format.....	2-3
2-2-4. Digital Audio Interface.....	2-4
2-2-5. IEC Format and Fostex Format.....	2-4
2-3. The DAT Cassette Tape.....	2-5
2-3-1. The Erase Prevention Hole.....	2-5
2-3-2. Notes on Tape Handling and Storing.....	2-5
2-3-3. Loading and Unloading the Cassette Tape.....	2-6
2-4. Non-recorded and No-sound Recorded Sections.....	2-7
2-5. Sub-ID.....	2-8
2-6. Using the Rack Mount Adaptor.....	2-9

Chapter 3 Names and Functions of the Controls and Connectors

3-1. Front Panel Section.....	3-1
3-2. Display Section.....	3-19
3-3. Rear panel Section.....	3-26

Chapter 4 Basic Operation

4-1. Basics of Audio Recording.....	4-1
4-2. Analog Audio Signal Recording.....	4-2
4-2-1. Insert Recording of Analog Audio Signals.....	4-4
4-2-2. Assemble Sound Recording of Analog Audio Signals.....	4-5
4-2-3. Assemble Sound Recording in the Confidence Mode.....	4-6
4-2-4. Analog Audio Signal Recording Level Adjustment.....	4-7
4-3. Digital Audio Signal Recording.....	4-8
4-3-1. Insert Recording of Digital Audio Signals.....	4-10
4-3-2. Assemble Sound Recording of Digital Audio Signals.....	4-11
4-3-3. Assemble Sound Recording in the Confidence Mode.....	4-12
4-4. Making No Recorded Section (REC MUTE).....	4-13
4-5. Sound Recording without Non-recorded Section (BLANK SEARCH).....	4-14
4-6. Basic Playback.....	4-15
4-7. Various Playbacks.....	4-18
4-7-1. Cuing in the JOG/SHTL Mode.....	4-18
4-7-2. Cuing in the RAM SCRUB Mode.....	4-19
4-7-3. S-ID Search.....	4-20
4-7-4. Time Locate.....	4-22
4-8. INSTANT START Mode.....	4-25
4-8-1. INSTANT START Operation.....	4-25
4-8-2. Execution of INSTANT START after Shift of Start Point.....	4-26
4-8-3. Rehearsal of INSTANT START with the PREVIEW/REPEAT Key.....	4-27
4-8-4. Locate/Search Using the INSTANT START Function.....	4-28
4-9. AUTO CUE Mode.....	4-30
4-9-1. S-ID Search Using the AUTO CUE Mode.....	4-31

Chapter 5 SUB-ID Recording and Erasure

5-1. S-ID/P-NO Recording.....	5-1
5-1-1. Automatic S-ID/P-NO Recording During Audio Signal Recording (AUTO-ID Function).....	5-2
5-1-2. Manual S-ID/P-NO Recording During Audio Signal Recording.....	5-4
5-1-3. Manual S-ID/P-NO Recording while Playing Back Sound-Recorded Tape.....	5-6
5-1-4. S-ID/P-NO Recording by Cuing the JOG/SHTL or RAM SCRUB Mode.....	5-8
5-1-5. S-ID Recording with NEXT P-NO Input During Sound Recording or Playing Back.....	5-10
5-1-6. Recording of P-NO Continuous from the Head of Tape (Renumbering Function).....	5-12
5-2. S-ID/P-NO Erasure.....	5-14

Chapter 6 Time Code Recording

6-1. Recording Time Code Generated by the INT Generator.....	6-2
6-1-1. Simultaneous Time Code Recording with Audio Signals.....	6-2
6-1-2. Time Code Recording on the Recorded with Audio Signals.....	6-4
6-1-3. Recording of Continuous Time Code Starting Halfway.....	6-6
6-2. Recording of Externally Supplied Time Code.....	6-7
6-2-1. Connections.....	6-7
6-2-2. Time Code Recording Operation.....	6-8

Chapter 7 Data Edit Mode

7-1. Data Edit Mode Operation.....	7-1
7-1-1. Editing of Memory Locate Time data (RECALL/> → MEM LOC).....	7-2
7-1-2. Editing of GENERATE TIME Supplied by the INT Generator (RECALL/> → TC GEN).....	7-4
7-1-3. CHASE OFFSET Edit (RECALL/> → CHASE).....	7-6
7-1-4. NEXT P-NO Input (RECALL/> → S-ID WRITE).....	7-8

Chapter 8 Applications

8-1. Chase Synchronization Function.....	8-1
8-1-1. Connections.....	8-1
8-1-2. Operation.....	8-2
8-2. Audio Editing with the D-25 Connected to the D-30.....	8-3
8-2-1. Connections.....	8-3
8-2-2. Operation.....	8-4

8-3. Control with an Editor.....	8-5
8-3-1. Connections.....	8-5
8-3-2. Operation.....	8-6

Chapter 9 Setup Mode

9-1. SETUP Mode.....	9-1
9-2. Display.....	9-2
9-3. Execution of Each Menu.....	9-4
9-4. Details of the SETUP Menus.....	9-5
Confirmation of the ROM version.....	9-5
Setting of the REFERENCE LEVEL.....	9-5
Setting of PAUSE OFF TIME.....	9-5
Setting of the DIGITAL OUT format.....	9-6
Setting of ON/OFF of the AUTO ID mode.....	9-6
Setting of the AUTO AUDIO EE mode.....	9-6
Setting of the AUTO TC EE mode.....	9-6
Setting of PANEL LOCK for remote controlling.....	9-7
Setting of the AUTO CUE/AUTO ID detection level.....	9-7
Setting of the AUTO CUE/AUTO ID detection time.....	9-7
Setting of ON/OFF of cuing action in response to SHUTTLE command.....	9-8
Setting of VCR emulation.....	9-8
Setting of the playback time code.....	9-9
Setting of the TC frame rate.....	9-9
Setting of ON/OFF of TC output during PAUSE.....	9-10
Setting on or off of time code output during FAST FORWARD.....	9-10
Setting on or off of time code output during REWIND.....	9-10
Setting of time code to be output.....	9-11
Setting of frame pulse output.....	9-11
Setting of the INT generator function mode.....	9-11
Setting of the CHASE function mode.....	9-12
Setting of LOCK WINDOW.....	9-12
Execution of the renumbering function.....	9-12
Execution of user memory ALL RESET.....	9-13

Chapter 10

Specifications.....	10-1
---------------------	------

Introduction



Objective of This Manual

We at Fostex want you to use this manual as a guide book for best use of our Digital Master Recorder Model D-25.

The main features of the D-25, names and functions of each component, and operating methods for the D-25 are explained in each chapter. Furthermore, precautions, notes on safety, and after-service are explained in detail. We recommend that you keep this manual handy at all times.

Chapter 1 Outline and outstanding features.

Chapter 1 is a general outline of the outstanding features and functions of the D-25.

Chapter 2 Preliminary notes before operating.

Installation prior to operation and general information related to digital audio tape recording are explained here.

Chapter 3 Names and functions of the controls and connectors.

Chapter 3 give details on the names and operating methods of the control buttons, switches, and connectors on the front and rear panels of the D-25.

For those accustomed to professional DAT recording, explanations here are compiled so that basic operation of the D-25 can be easily understood if this chapter is read first. Other chapters can be referred to as necessary.

Chapter 4 Basic operating procedures.

In this chapter, basic operating methods of the D-25 such as analog and digital audio signal recording and playback, search and locate function, and instant start are explained.

Chapter 5 Time code recording.

Recording of time code from the D-25 internal time generator or externally input time code is explained in this chapter.

Chapter 6 Record and erase of sub ID.

Record and erase methods of sub ID (START-ID/P-NO.) that is important for DAT recording and the renumbering function are explained here.

Chapter 7 Data edit mode.

Various editing methods such as CHASE OFFSET TIME during chase operation, GENERATE TIME of the internal generator, editing of memory time and, setup of NEXT P-No. for S-ID recording are explained.

Chapter 8 Various applications.

Actual examples of the D-25 functions such as chase operation of external equipment connected to the D-25, an audio system by combining a D-30 and a D-25, and control of the D-25 using various types of video editing machines are explained here.

Chapter 9 SETUP mode.

This chapter explains the contents and methods of the various setup modes necessary for using the D-25. In the SETUP mode, various setup items designed for optimum performance depending on what the objective is for using the D-25 are described.

Contents of This Manual

Many terms related to DAT appear in the explanations of each chapter of this manual. These special terms are expressed by the following abbreviations in the text.

* A time/absolute time	A-TIME
* Sampling frequency	FS
* Start ID	S-ID
* Program number	P-NO
* End ID	END-ID
* Skip ID	SKIP-ID
* Time code	TC
* Internal	INT
* External	EXT
* Generator	GEN

As a rule, when describing the switches, keys and input/output jacks, the panel letterings itself will be used.

[Example]

* Record button	RECORD button
* Emphasis switch	EMPHASIS switch
* Blank search key	BLANK SEARCH key
* Analog input connector	ANALOG INPUT connector

Words enclosed in brackets [] are the names of the panel switch position, display messages, and words on the panel or in the display.

The LED indicators and operating button lamps will be expressed as "lit," "blink," "fast blink", or "extinguished" and any messages shown in the display as "display."

In conventional analog recorders, audio signal recording is referred to as "sound recording" but in this manual, audio signal recording will be referred to as "sound recording" and those for various ID's and time codes as "record."

In the text, please read the information under <NOTE> and <IMPORTANT>. These notes will explain important points for correct operation and handling of the D-25.

It is our hope that you carefully follow the above notes and carefully read this manual for full understanding and best performance of this equipment.

Chapter 1
Outline and Outstanding Features



1-1. General Outline

The D-25 follows our acclaimed D-30 digital master recorder as a commercial DAT master recorder designed with the assumption that it will be controlled by SONY 9 pin PROTOCOL.

The D-25 includes Fostex exclusive RAM SCRUB and INSTANT START functions as well as the ability to record and play back IEC format SMPTE/EBU time code necessary for commercial applications. Several remote connectors are provided to control of the D-25 with external video editors, etc. The D-25 can also perform as a high level editor in broadcasting stations and for post production work.

1-2. Main Features of The D-25

* RAM for INSTANT START

INSTANT START and RAM SCRUB functions are possible using the RAM installed.

The outstanding feature of Fostex exclusive RAM SCRUB is that input and retrieval of data into the RAM is very easy. Furthermore, these operations are done in real time for optimum accuracy.

* Mechanism

The D-25 has a stable tape transport utilizing a 2DD motor.

By using four heads, it is possible to simultaneously monitor (off tape monitor) played-back sound during recording.

* External Sync

The D-25 complies to various external sync signal formats and thus can be synchronized with external equipment.

- * Accepted external sync signals:
- * Video sync signal (composite, frame pulse, field pulse)
- * Word sync signal
- * Digital input signal

Termination switches are provided in all external sync related input and output points. In addition, INPUT THRU connectors are provided on the back panel for easy wiring in the field.

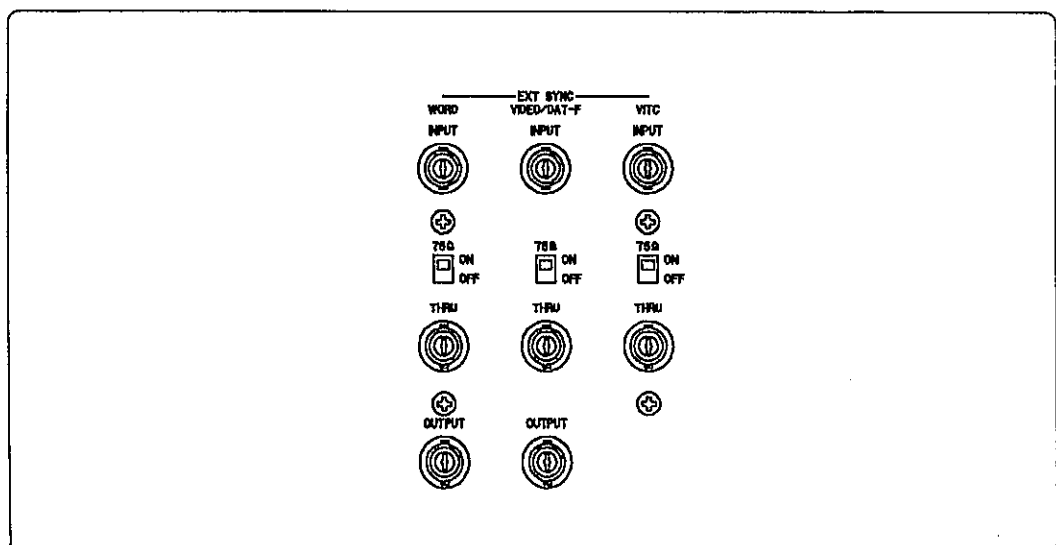

*** Record/playback of Time Code (TC)**

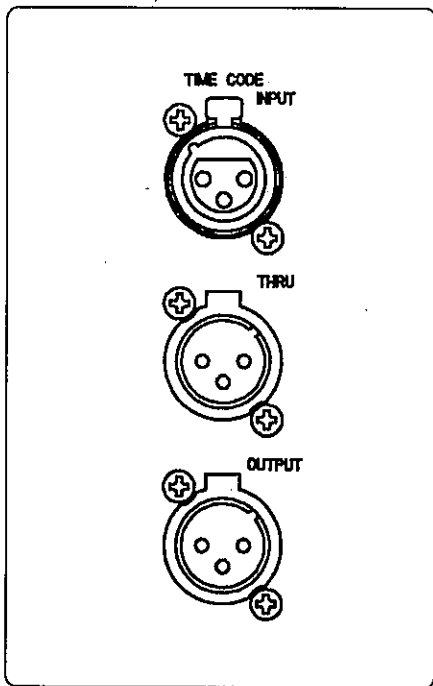

The D-25 records and plays back IEC format SMPTE/EBU time code using the sub code area. A high speed reader and VITC reader function is included in the time code reader.

Sync with the internal time generator using an external sync signal (video sync signal/external TC) is possible. Also, external time code can be force jammed using the jam function.

*** Remote Control**

Various remote connectors for controlling external equipments are provided in the D-25.

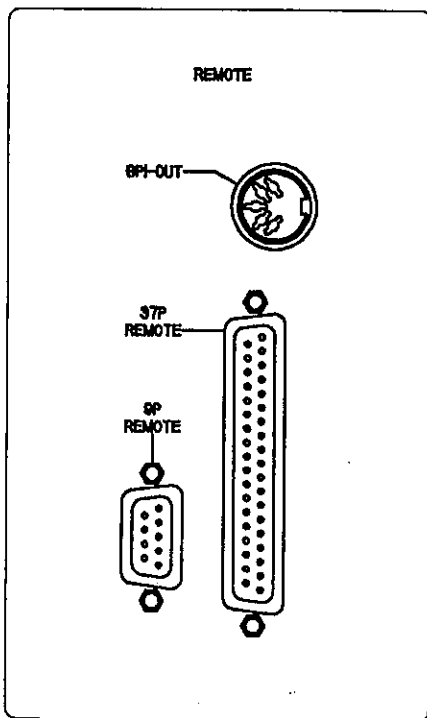

9P-REMOTE (RS-422) connector

This connector complies with the SONY 9 PIN PROTOCOL making audio editing possible in combination with a Fostex D-30 and various video editors.

37P-REMOTE (D-sub 37 pin) connector

Pin functions of this connector comply with the parallel remote connector on the SONY PCM-7000 series. Fader start is possible by using this connector.

GPI OUT (DIN 5 pin) connector

This connector is provided for future function extension.

Chapter 2

Notes Prior to Operation

Precautions before operating the Model D-25 are explained in this chapter.

Chapter 2 Table of Contents

2-1

2-1. Notes on operation.....	2-1
2-1-1. Precaution at Installation.....	2-1
2-1-2. Precaution on Dewing.....	2-1
2-1-3. Precautions on Safety.....	2-1
2-2. DAT.....	2-2
2-2-1. DAT Specifications.....	2-2
2-2-2. Four Head System and Simultaneous Playback Monitor.....	2-2
2-2-3. Track Format.....	2-3
2-2-4. Digital Audio Interface.....	2-4
2-2-5. IEC Format and Fostex Format.....	2-4
2-3. The DAT Cassette Tape.....	2-5
2-3-1. The Erase Prevention Hole.....	2-5
2-3-2. Notes on Tape Handling and Storing.....	2-5
2-3-3. Loading and Unloading the Cassette Tape.....	2-6
2-4. Non-recorded and No-sound Recorded Sections.....	2-7
2-5. Sub-ID.....	2-8
2-6. Using the Rack Mount Adaptor.....	2-9

2-1. Notes on Operation

2-1-1. Precaution at Installation

Do not operate this equipment in following locations.

- * Where it is extremely hot or cold.
- * Where humidity is high.
- * Where it is very dusty.
- * Where vibration is strong.
- * In a strong magnetic field.
- * Under direct sunlight for long periods or near room heaters. When used near a video monitor, it is advised to use a video shield.

2-1-2. Precaution on Dewing

If this equipment is moved suddenly from a cold to a warm location or if the room is heated rapidly, the recording tape may cling to the head drum or wrap around it and thus damage it.

Therefore, the D-25 should be left idle for about two hours before loading tape or until the recorder becomes accustomed to the ambient temperature.

In the same way, if a DAT cassette tape is brought into a warm place from the cold such as in winter, moisture is apt to collect on the tape and, if it used in this condition, the tape could be damaged. Let the tape stand for about two hours in the room until its temperature is the same as that of the environment.

2-1-3. Precautions on Safety

- * When disconnecting the power cord from the wall outlet, be sure to hold the plug when pulling it out. If only the cord is pulled, the wire inside could break and this is very dangerous.
- * Do not plug or unplug the cord from the wall outlet with wet hands. You could get a dangerous electric shock.
- * Be sure all power cord plugs are positively plugged into the wall outlet and to the equipment.
- * Using any power cord with damaged outer insulation is very dangerous. Should the insulating sheath be damaged, discard the cord and replace it with a new power cord.
- * Do not switch off the D-25 with cassette tape loaded. Always remove the tape first before switching off.
- * We recommend unplugging the power cord from the wall outlet if the recorder is not to be used for long periods.
- * Except when installing the optional memory board, do not remove the equipment cover or touch anything inside. Doing so could result in breakdown or damage and you could receive an electric shock. This is dangerous - don't do it.
- * Do not let any liquids or small metal objects such as hair pins, etc. get inside the recorder, especially into the transport. This could result in breakdown and is also very dangerous. If any liquid should accidentally get inside, switch off the power immediately, unplug the cord from the wall outlet, and consult your nearest Fostex dealer or distributor.
- * Do not drop or apply strong shocks to the recorder. This will damage the internal circuits and liquid crystal display.

2-2. DAT

2-2-1. DAT Specifications

This product is a professional digital audio recorder complying to the IEC DAT (Digital Audio Tape system) specifications.

The DAT specification is composed of the following six parts:

- Part 1: Dimensions and characteristics
- Part 2: DAT calibration tape
- Part 3: DAT tape properties
- Part 4: Methods of measurement for DAT recorders
- Part 5: DAT for professional use
- Part 6: SCMS for consumer audio use DAT recorders

Part 1 ~ 4 and Part 6 are the conventional consumer DAT specifications.

The Part 5 professional specifications have been added to these. As this equipment complies to all DAT specifications except Part 6, tape is interchangeable regardless to consumer or professional use.

2-2-2. Four Head System and Simultaneous Playback Monitor

In DAT, by using a high-speed helical scan rotating head with high density metal tape, a high frequency band of several MHz is attained for digital signals.

The D-25 employs a 30mm diameter small size head drum and by using a 90 degree tape wrap angle, simultaneous playback monitoring (off tape monitoring) is possible. As shown in the schematic, two sets of paired heads counterpoised 180 degrees apart (A, B and A', B') are placed 90 degrees to each other.

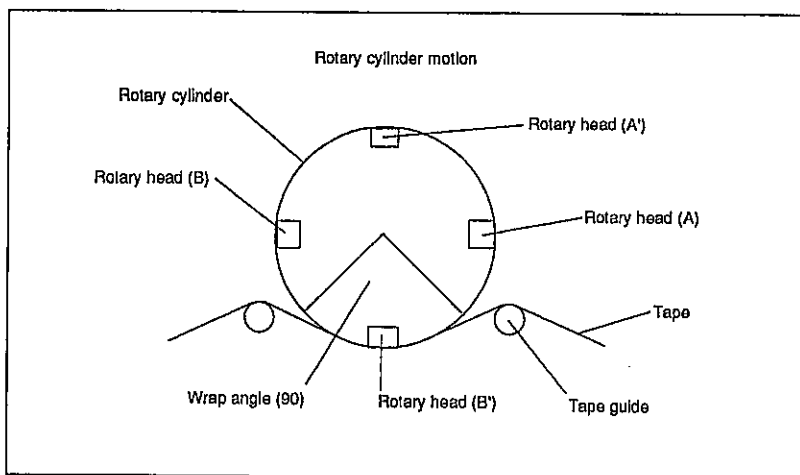

The leading pair heads (A, B) are used for recording and the trailing heads (A', B') for playback. Delay time for the playback monitor is about 200msec.

<Order of sampling>

In consumer DAT, two channel simultaneous sampling and two channel alternate sampling are both possible. Because the two channel simultaneous sampling method is used in the Fostex D-25, if a tape recorded by two channel alternate sampling is played back on this machine, an approximately 10 μ sec. phase difference will occur.

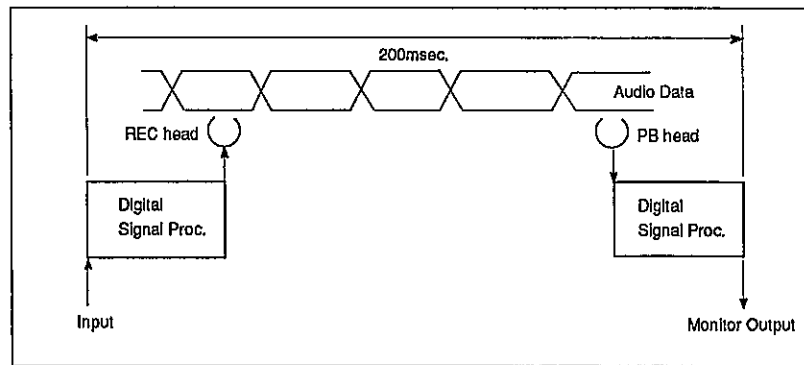

2-2-3. Track Format

In the DAT track format, various information is recorded in segments on one track. Therefore, various ID's and time code can be recorded without affecting the audio signal. The reason for situating the sub data area and ATF area in separate locations is to prevent burst error caused by the tape and to secure positive reading of data during high speed searching.

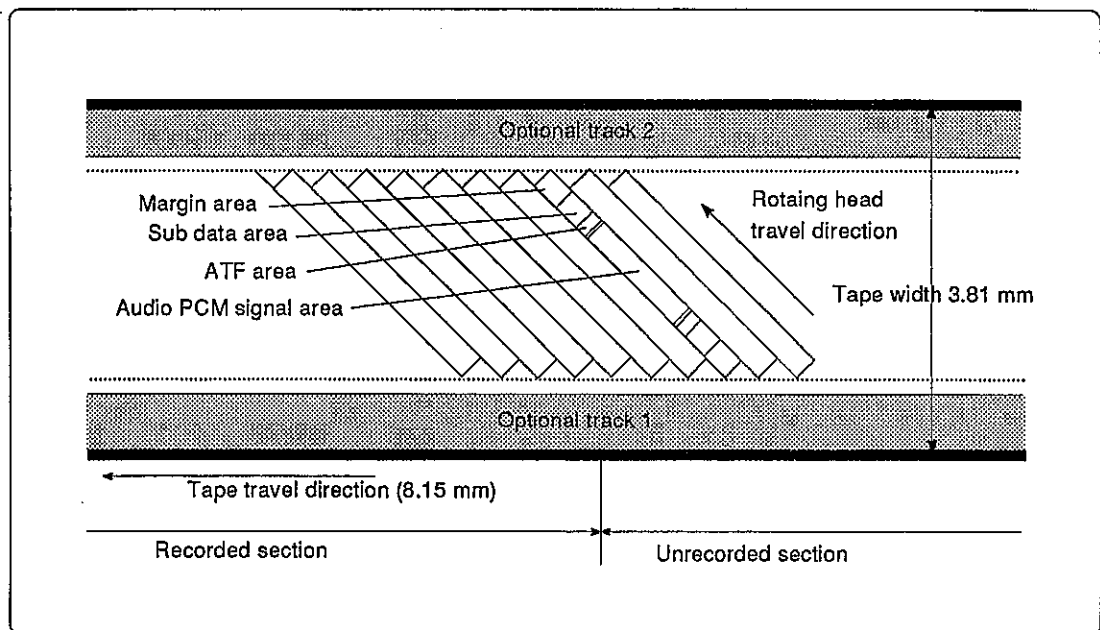

1. Audio PCM signal area

In addition to audio signals (L, R mixed) converted to digital data by PCM (Pulse Code Modulation) and main data consisting of error correcting codes (double Read Solomon code), the main ID for discriminating the audio data content are recorded here.

2. Sub data area

In this area are recorded data other than audio signals such as start ID, program numbers, A-time and program time. Recording capacity of this area is four times that of CD and various applications can be assumed. Time code data is recorded here.

3. ATF (Automatic Track Finding/Following) area

Tracking detecting signals are recorded here so that the head will accurately trace the track at playback. This is composed of a 130kHz pilot signal and signals for track discrimination.

2-2-4. Digital Audio Interface

The digital audio interface is a serial self synchronizing transmission system specification for use when interconnecting digital audio equipment and is standardized in IEC Specification 958.

This is identical with CP-340 in the EIAJ specification and consists of the following two formats:

- * Commercial use: AES/EBU (IEC 958 broadcasting studio use)
- * Consumer use : IEC 958 consumer use

The D-25 comply to both formats and the output can be selected.

Connecting Specifications

The following two types are specified in the IEC Specification.

1. Balanced type : XLR connector, cable impedance 110 Ω
2. Unbalanced type : US pin jack, cable impedance 75 Ω

Which of these should be used is not prescribed in the IEC specification but in general, the balanced type is used in the AES/EBU format and the unbalanced type in the Consumer Use format. However, there are regulations on this matter in the EIAJ specification.

2-2-5. IEC Format and Fostex Format

The D-25 complies to the two time code formats at playback of time codes.

FOSTEX format

This format was originally developed by Fostex and adopted for the first time in its digital master recorder Model D-20B at a time when DAT time code format was not yet standardized. The outstanding feature of the Fostex format is that the time code is simply handled as 80bit data.

<NOTE>

The Fostex format cannot be recorded by the D-25.

IEC format

Eventually, DAT time code format was specified by IEC.

The outstanding feature of IEC format is that time code is converted to Pro R-Time, which is the frame time information peculiar to DAT, and then recorded.

Because conversion is based on the frame, it can be readily converted to different frame rates. For example, a recording of SMPTE time code (30F, 29.97F) can be played back as an EBU time code (25F). However, a delay of more than one frame in the user bit will occur as the time code is decoded prior to recording it. At present, data which can be recorded in the binary group (U-Bit: user bit) is limited to static data.

2-3. The DAT Cassette Tape

The cassette tape exclusively designed for DAT is used in the D-25.

In DAT, unlike conventional cassette decks, record and playback are possible in only one direction. Therefore, when loading the tape, it must be set in the direction shown in schematic below.

<NOTE>

Do not use T-180 tape.

Because T-180 tape is very thin, it is apt to wind on the head drum thus damaging it and causing recorder breakdown

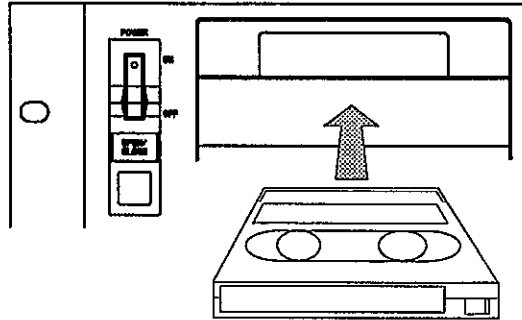

2-3-1. The Erase Prevention Hole

If a prerecorded tape is recorded again, the previous recording will be erased.

As shown in the schematic, there is a lid on the erase prevention hole of the DAT tape. This is provided to prevent accidental erasing of any previous recording. Move this lid as necessary.

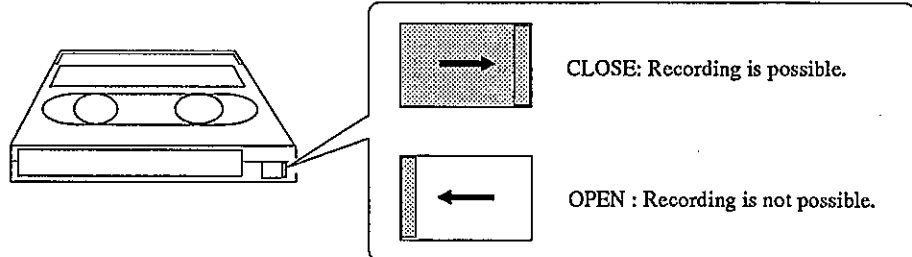

<NOTE>

When this lid is open, audio, signal/time code recording, and S-ID recording/erasing cannot be executed. Therefore, be sure to check the status of this lid before recording.

2-3-2. Notes on Tape Handling and Storing

When using DAT tape, be careful of the following items.

1. If a tape is brought inside to a warm room from the cold, moisture often collects on it. In such a case, leave the tape in the room for about two hours until it is at room temperature. The tape will be damaged if it is used with dew on it.
2. Do not dry tape with moisture on it with a hair drier. The tape will be distorted in shape.
3. Do not open the cassette lid and draw out the tape or touch the tape with your fingers.
4. Cassettes cannot be loaded upside down.
5. Do not drop or apply physical shock to the tape cassette.
6. Dust and dirt are enemies of the tape. When not in use, put all cassettes in their case before storing.
7. Do not place or store in locations where:
 - * Temperature and humidity is high.
 - * There is a strong magnetic field (near televisions or speakers).
 - * Direct sunlight shines for long hours.

2-3-3. Loading and Unloading the Cassette Tape

Load and unload the cassette tape as follows.

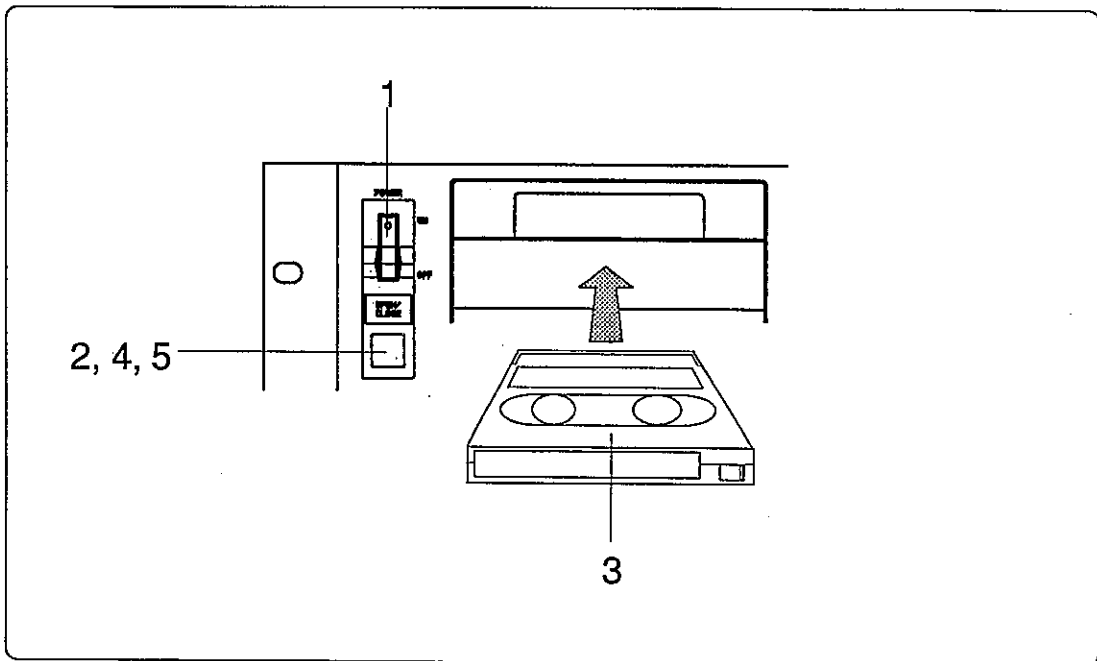

Operating Procedure

1. Switch on power.
2. Press the OPEN/CLOSE button to open the cassette tray.
3. Load the cassette.

As shown in the schematic, place the cassette face upward.

<NOTE>

The tray will not close correctly if the cassette is loaded in the wrong direction.

4. Press the OPEN/CLOSE button to close the tray.
As an alternative, lightly press the front face of the tray or press the PLAY or STOP button and the tray will be closed.
5. To unload the tape, press the OPEN/CLOSE button again.

2-4. Non-recorded and No-sound Recorded Sections

In conventional analog recorders, "blank sections" between tunes were made with the playback mode or by advancing the tape in fast-forward (non-recorded section) or, by continuing recording without any sound (no-sound recorded section). The difference between "non-recorded section" and "no-sound recorded section" is as shown in the schematic below.

【Non-recorded (blank) section】

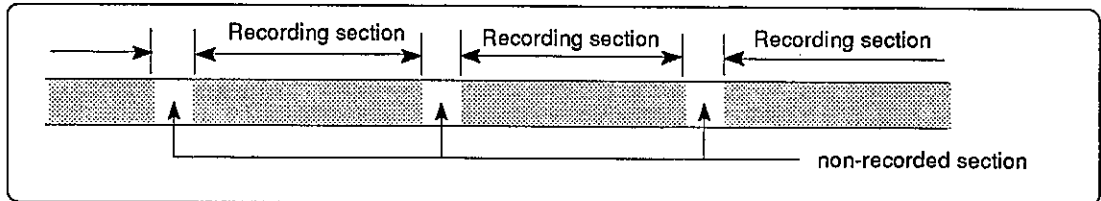

【No-sound recorded section】

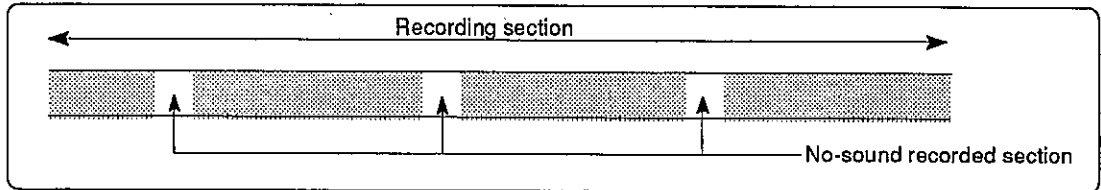

As explained above, there is a distinction between a "non-recorded section" and "no-sound recorded section" whereby a "blank section" is made in the no-recording mode such as playback or fast-forward, or making a "blank section" by recording a certain length with no sound.

In analog recorders, a blank section was the same as "no sound" in either case.

However, when making a blank section between tunes on a DAT tape, it must be made by "no-sound recording" and not in the "non-recording" mode.

The reason for this is because if a "non-recorded section" is made such as in an analog recorder (fast forward, etc.), the A-TIME which is automatically recorded on the tape will be discontinuous requiring a lot of time to locate the tape's start point and, as a result, hamper performance. Therefore, it is important that blank sections be made using the REC MUTE function.

* For details on No-sound recording (REC MUTE), refer to page 4-13.

2-5. Sub-ID

In DAT, various control signals (Sub-ID), in addition to the regular music signals (audio data), can be recorded in the sub data area.

Using this Sub-ID, selecting tunes and locating the start of the tune at playback, and editing of prerecorded tapes is possible. A Sub-ID can be automatically recorded during a recording session or during playback of a prerecorded tape, and it can be freely recorded, rewritten or erased. However, because there is a limit to the possible Sub-ID's which can be recorded or erased by the D-25, please refer to the list below.

Sub-ID's which can be recorded and erased in the D-25 are as follows:

Name	Function	Record	Erase
S-ID:	The signal indicating start point of tune and is used to locate this point.	Possible	Possible
P-NO:	A number assigned to S-ID and the desired tune can be assigned and located to its starting point.	Possible	Possible
SKIP-ID:	The signal for skipping to the next tune (S-ID) when it is inserted inside a tune.	Not possible	Not possible
END-ID:	The signal indicating end of recording.	Not possible	Not possible

<NOTE>

SKIP-ID and END-ID can be edited by communicating through 9 PIN REMOTE..

2-6. Using the Rack Mount Adaptor

Rack mount adaptors are installed as standard items on both sides of the D-25. In rack mounting the D-25, by changing the adaptor mounting position it can be used in two different ways as shown below. Select either method according to your requirements.

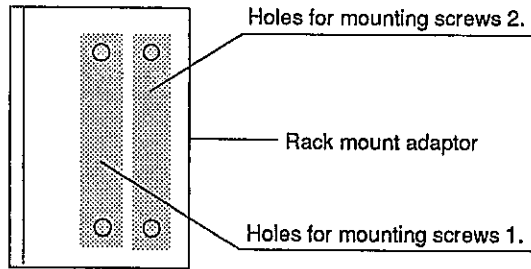

1. When mounting screw ① is used:

The main unit front panel section will extend beyond the rack front plane when installed in the rack.

* The adaptor is mounted in this position when leaving the assembly plant.

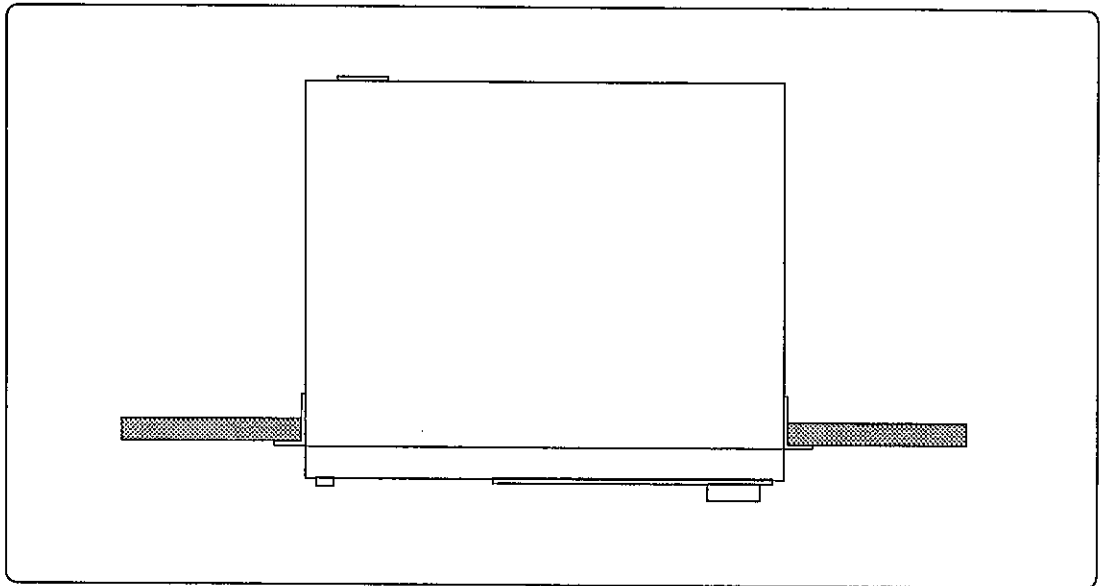

2. When mounting screw ② is used:

The main unit front panel face will be almost flush with the rack front plane.

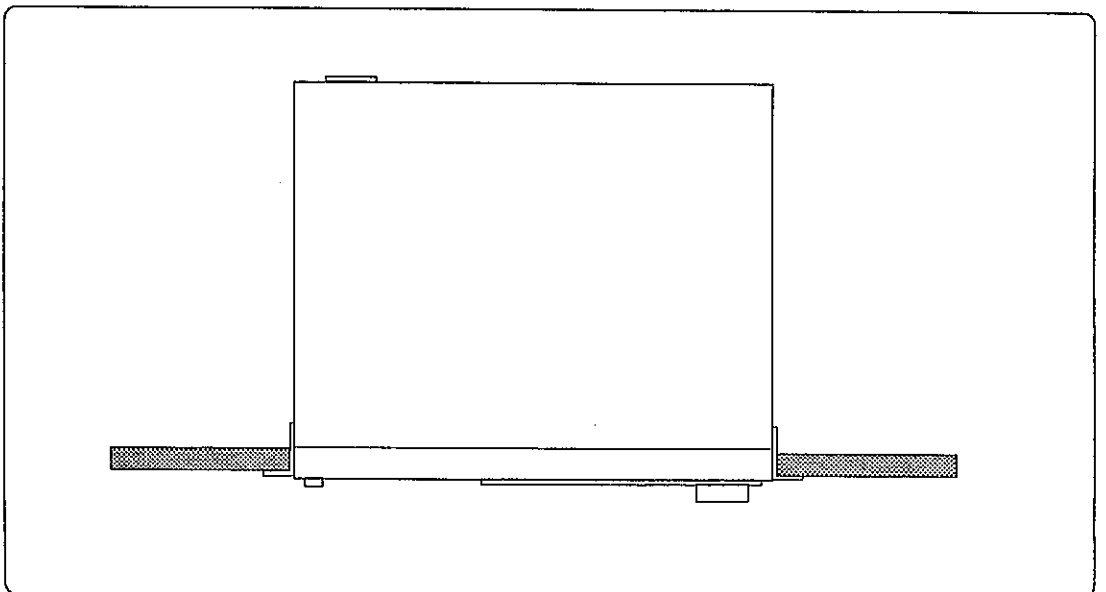

MEMO

2024

A series of horizontal dotted lines for writing, spanning the width of the page.



Chapter 3

Names and Functions of the Controls and Connectors

In this chapter, names and functions of the front panel buttons, keys and switches are given, and the rear panel connectors and the display are explained.

Chapter 3. Table of Contents

3-1. Front Panel Section.....	
POWER switch.....	3-2
OPEN/CLOSE key.....	3-2
PHONES knob, PHONES jack.....	3-2
Cassette tray.....	3-3
INSTANT START key.....	3-3
AUTO CUE key.....	3-3
BLANK SEARCH key.....	3-4
START ID SEARCH key.....	3-4
STOP, RECORD button.....	3-5
PLAY, F FWD, REWIND button.....	3-6
FL display.....	3-7
DISP TIME selecting key.....	3-7
DISP LEVEL selecting key.....	3-7
MARGIN RESET key.....	3-7
JOG/SHTL key, RAM SCRUB key.....	3-8
PREVIEW/REPEAT key.....	3-9
JOG/SHTL lamp.....	3-9
JOG/SHUTTLE dial.....	3-9
MEM LOC key, RECALL/> key.....	3-10
SETUP, MARK/SET/EXECUTE, CHASE key.....	3-11
TC GEN key.....	3-12
FORCE JAM/QUIT key.....	3-12
CATCH OFFSET key.....	3-12
S-ID WRITE/S-ID ERASE key.....	3-13
CONFIDENCE MONITOR key.....	3-14
AUDIO MONITOR key.....	3-14
MUTE key.....	3-14
ASSEMBLE key, TC INSERT, AUDIO INSERT key.....	3-15
INPUT LEVEL knob.....	3-16
EMPHASIS, SAMPLING FREQ selecting switch.....	3-16
CLOCK switch.....	3-17
INPUT selecting switch, REMOTE/LOCAL selector switch.....	3-18
3-2. Display Section.....	3-19
3-3. Rear panel Section.....	3-26
ANALOG INPUT/OUTPUT connector.....	3-27
DIGITAL INPUT/OUTPUT connector.....	3-28
REMOTE connector.....	3-29
TIME CODE INPUT/OUTPUT connector.....	3-32
EXT SYNC connector.....	3-33
AC IN connector, GND terminal.....	3-36

3-1. Front Panel Section

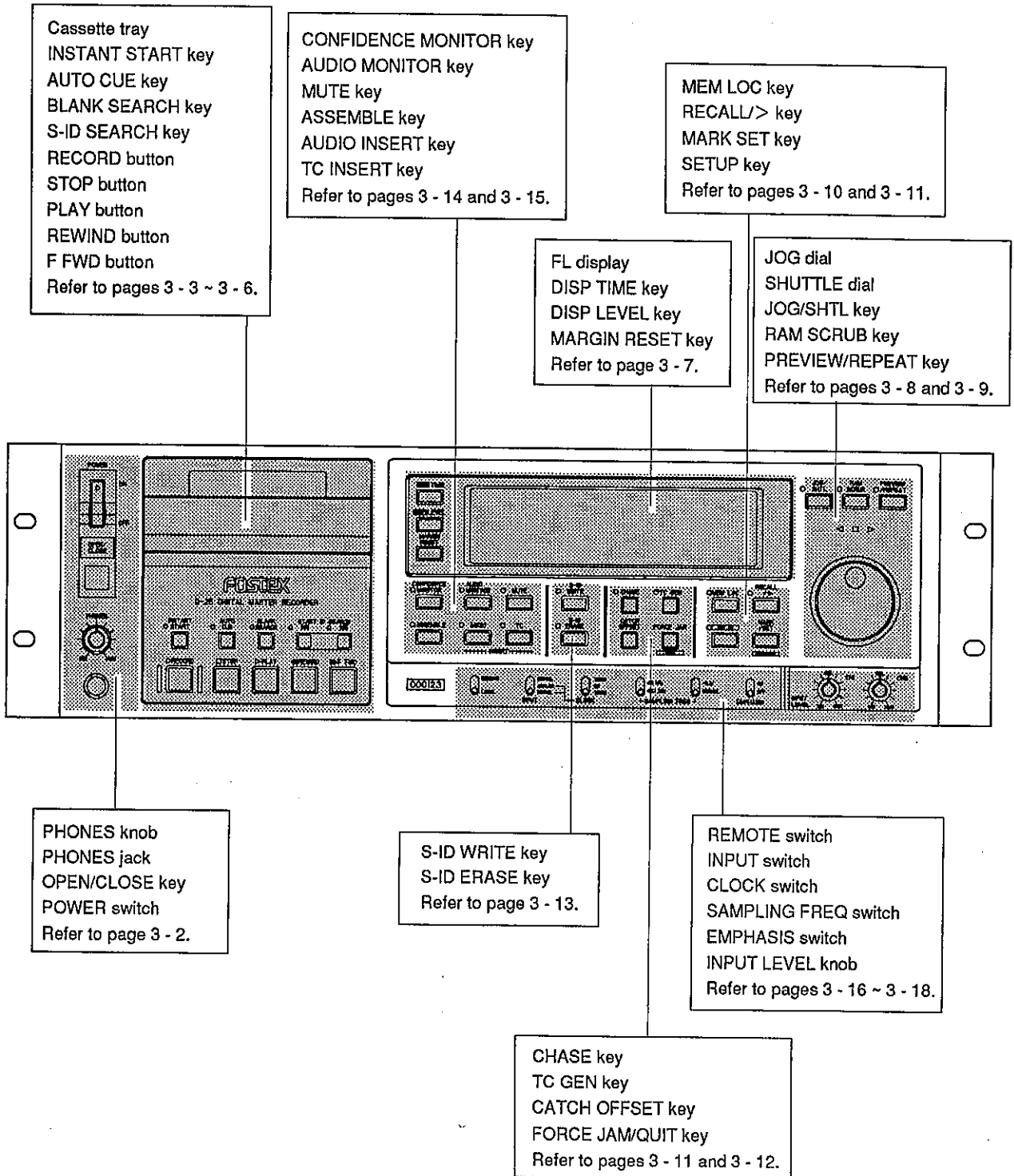

- POWER switch**
- OPEN/CLOSE key**
- PHONES knob**
- PHONES jack**

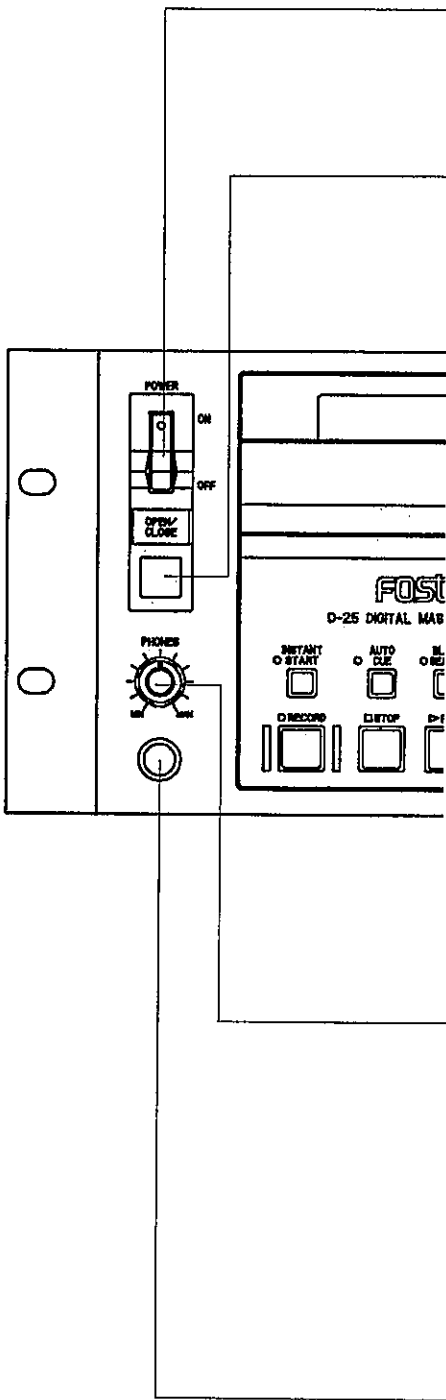
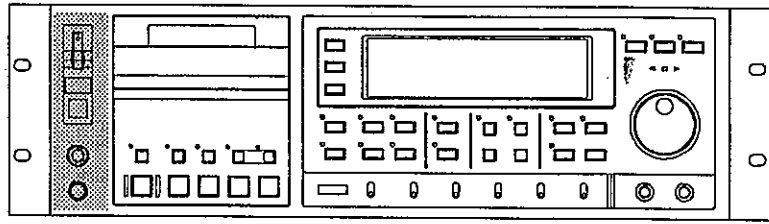

■ **POWER switch**

Switches the power on or off to the main unit.

■ **OPEN/CLOSE key**

The cassette tray will open or close alternately with each press of this key.

If a tape is set in the tray when it is closed, tape will be loaded and the D-25 will enter the pause mode. To close the tray, use the following procedures:

1. Press the PLAY button (the tape will load and the D-25 will enter PLAY).
2. Press the STOP button.
3. Lightly press front edge of the tray.

<NOTES>

- * The cassette tray can be opened only while in the STOP or PAUSE modes.
- * While in the INSTANT START mode off state, if the tape is in a non-recorded section when loaded, the D-25 will automatically enter the BLANK SEARCH mode.
- * Refer to chapter 4 (page 4 - 14) for details on BLANK SEARCH.

■ **PHONES (headphone sound volume) knob**

Adjusts the headphone monitoring level.

<NOTE>

In the SETUP mode, if the reference level is changed, the monitor output level will also change.

- * Refer to chapter 9 (page 9 - 5) for details on to set the reference level.

■ **PHONES (headphone) jack**

Receptacle for the headphone plug.

Cassette tray
INSTANT START key
AUTO CUE key

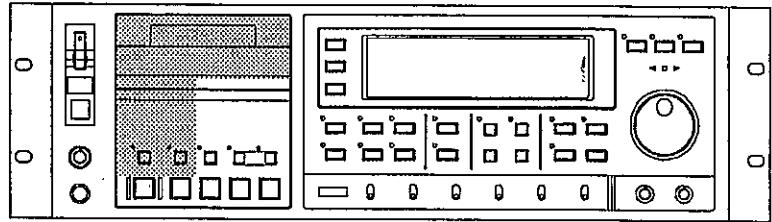

■ **Cassette tray**

The DAT cassette tape is placed here.
 Opening and closing of the tray can be done by the OPEN/
 CLOSE key, STOP or PLAY buttons.

* Refer to chapter 2 (page 2 - 6) for details on setting of the
 cassette tape.

■ **INSTANT START key**

With each press of this key, the INSTANT START mode will
 alternately switch on or OFF.
 INSTANT START can be executed only when the LED is lit.
 If this LED is blinking either fast or slow, the D-25 cannot
 INSTANT START for the following reasons:

Blink (slow)	Audio data is being stored into the RAM. Proceed to the next operation after it changes to constant light.
Blink (fast)	Instant start cannot be executed because there is no A-TIME or time code recorded on the tape. Rerecord A-TIME or TC on the tape.

* When the AUTO CUE and INSTANT START modes are in
 the on state, the AUTO CUE mode will switch off
 simultaneous with switching off of the INSTANT START
 mode.

* Refer to chapter 4 (page 4 - 25) for details on INSTANT
 START.

■ **AUTO CUE key**

The AUTO CUE mode switches on or off alternately with each
 press of this key.
 If this key is pressed while the INSTANT START mode is off,
 this mode will switch on at the moment this key is switched on.

* Refer to chapter 4 (page 4 - 30) for details on the AUTO CUE
 mode.

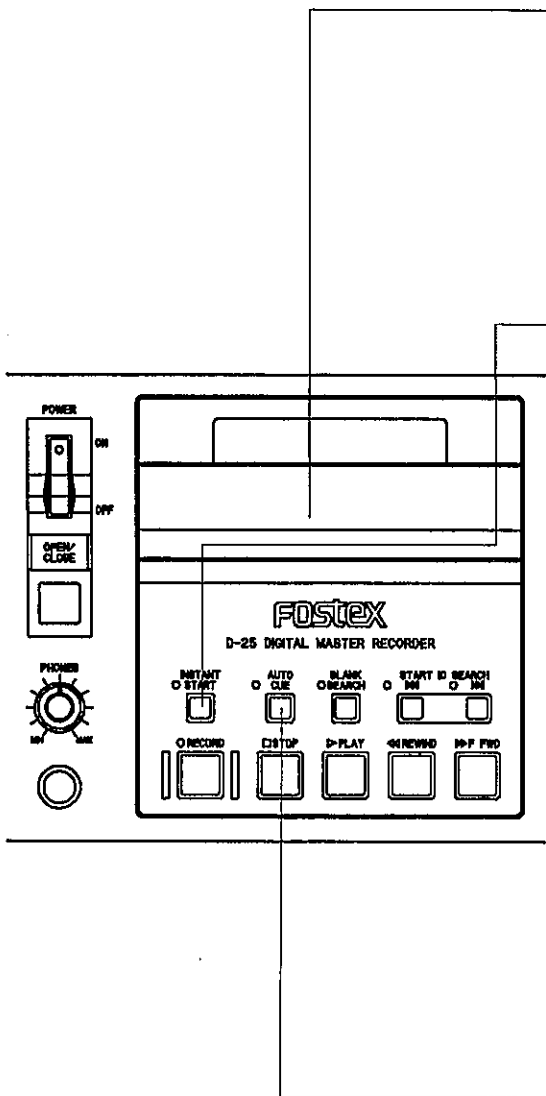

BLANK SEARCH key
START ID SEARCH (<< >>) key

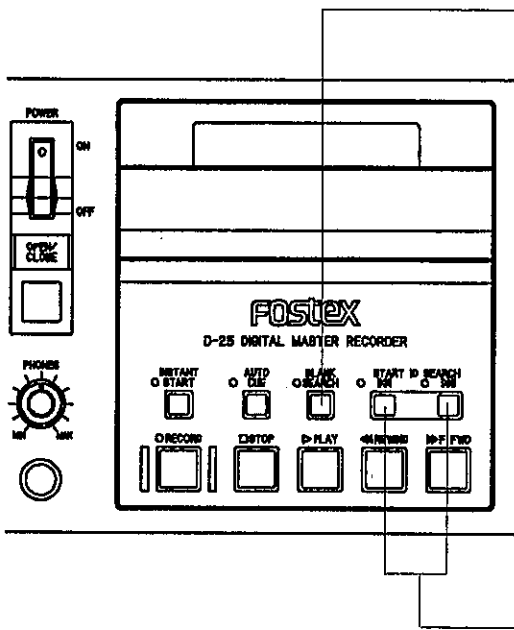
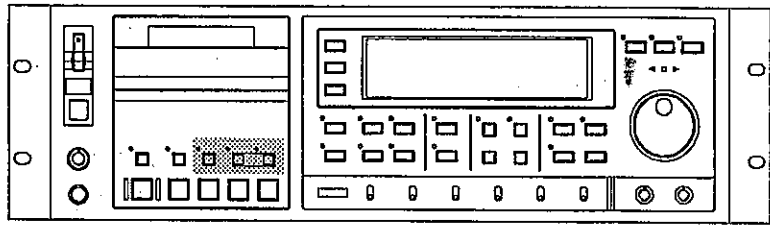

■ **BLANK SEARCH key**

Non-recorded sections of tape will be searched for when this key is pressed. The LED will light during search and extinguish when search is finished.

If an END-ID is recorded on the tape, the D-25 will pause two seconds before this END-ID.

<NOTES>

- * Recording or erasing of END-IDs is not possible with the D-25 alone.
- * A non-recorded section of 9 seconds or less might not be found in certain cases.
- * Refer to chapter 4 (page 4 - 14) for details on Blank Search.

■ **START ID SEARCH (<< >>)key**

An S-ID search for the number of times this key is pressed will be executed. The LED will light during execution and extinguish at the finish of execution.

<NOTE>

This function cannot be executed if no S-ID is recorded on the tape.

<< key	An S-ID is executed in the rewind direction for the number of times this key is pressed and upon completion of search, the D-25 will pause about one second before the objective S-ID.
>> key	S-ID is executed in the fast forward direction for the number of times this key is pressed and upon completion of search, the D-25 will pause about one second before the objective S-ID.

- * When S-ID search is executed with INSTANT START mode on, INSTANT START is possible from the head of the searched S-ID.
- * When S-ID search is executed with the auto cue mode in the on state, the recorder will accurately locate to the sound position before and after the searched S-ID.
- * The D-25 will enter SEARCH AND PLAY if the PLAY button is pressed during the S-ID search operation.
- * Refer to chapter 4 (page 4 - 20) for details on S-ID search.
- * Refer to chapter 5 for details on record/erase of S-ID.

RECORD button
STOP button

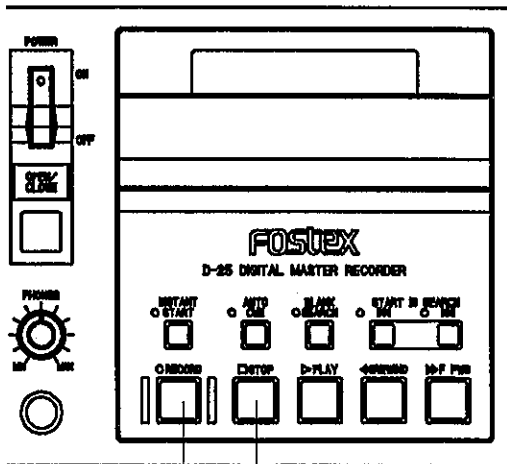
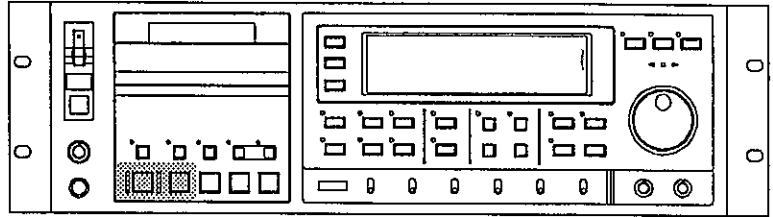

■ **STOP button**

The D-25 will alternately PAUSE-STOP each time this button is pressed.

During normal operation, the D-25 will enter PAUSE if this button is pressed once, the STOP button lamp will light and the PLAY button lamp will blink. If it is pressed once again, the D-25 will enter the STOP mode and the STOP button lamp only will light. If the cassette tray is open, it can be closed by pressing this button.

■ **RECORD button**

Recording will start when this button and the PLAY button are simultaneously pressed (PLAY and REC button lamps will light) when in the assemble mode or the insert mode on state.

<NOTES>

- * If the D-25's INSTANT START mode is on, it will not record but will enter the play mode.
- * The cassette cannot be recorded if the erase prevention hole is open.

PLAY button
REWIND button
F FWD button

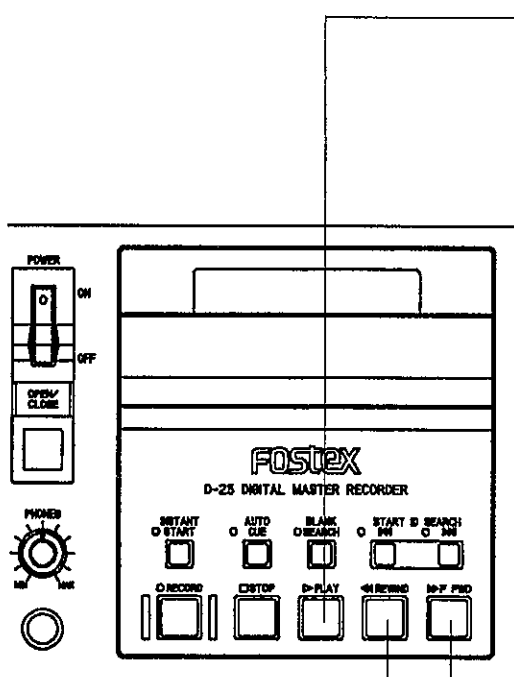
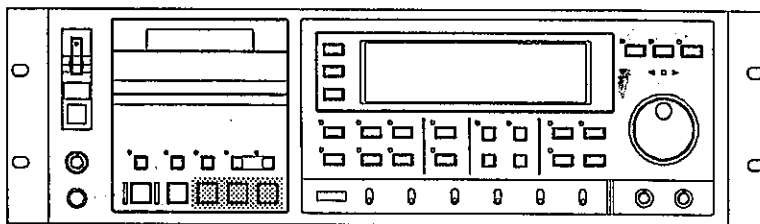

■ **PLAY button**

When this button is pressed during normal operation, the button lamp will light and the tape will roll.

Also, when this button is pressed during locate or search operations, the recorder will enter LOCATE (search) & PLAY, and then enter the PLAY mode upon completion of the LOCATE (search) operation.

Recording is started when this button and the RECORD button are simultaneously pressed while the D-25 is in the ASSEMBLE or INSERT (AUDIO or TC) mode.

<IMPORTANT>

When this button only is pressed while in the recording mode, the D-25 will punch out and enter the PLAY mode.

While in the INSTANT START mode on state, INSTANT START is executed by pressing this button.

If the cassette tray is open, it can be closed by pressing this button. The tape in the tray will be loaded and the D-25 entered into the PLAY mode.

<NOTE>

If INSTANT START key LED is blinking, INSTANT START will not execute even though the PLAY button is pressed. INSTANT START must be executed after the LED changes to constant light.

■ **F FWD (fast forward) button**

The fast forward mode will alternate between 5 times speed and high speed with each press of this button.

The D-25 will fast forward wind at 5 times speed if pressed once and the lamps of the PLAY and F FWD buttons will light. If pressed again, the D-25 will fast forward wind at high speed and only the F FWD button lamp only will be lit.

■ **REWIND button**

The rewind mode will alternate between 5 times speed and high speed with each press of this button.

Rewind at 5 times speed by pressing once and lamps of the PLAY and REWIND buttons will light. If pressed again, the recorder will rewind at high speed and the REWIND button lamp only will be lit.

FL display
DISP TIME key
DISP LEVEL key
MARGIN RESET key

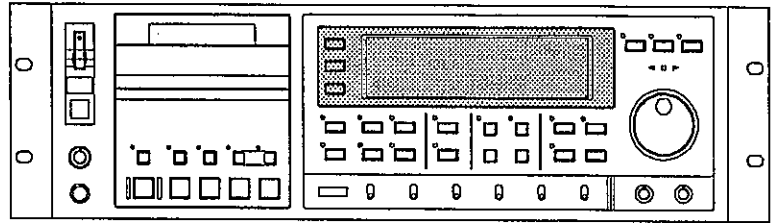

■ **FL display**

A-TIME, time information of the time code, audio signal level information and various settings can be shown on this display.

* Refer to chapter 3 (page 3 - 19) for details on the display.

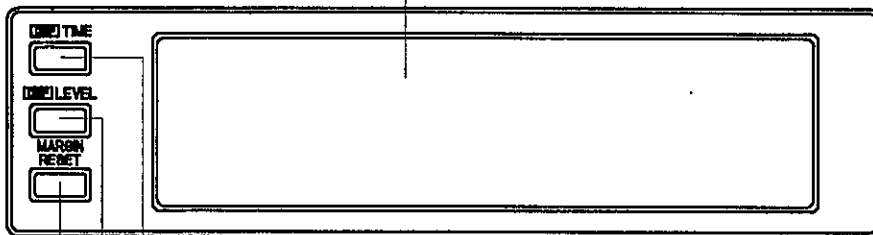

■ **DISP TIME (Time Display) selecting key**

With each press of this key, time information on the normal display mode will be changed as shown below. When power is switched on, the last display at switch off of power will be shown.



Press this key to exit from the data edit mode and the SETUP mode.

■ **DISP LEVEL (Level Indication) selecting key**

With each press of this key, level information of the normal display mode will change as follows. When power is switched on, the last display at switch off of power will be shown.

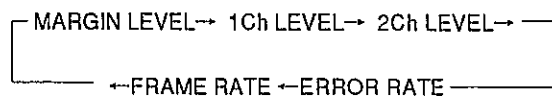

■ **MARGIN RESET key**

If this key is pressed while the margin level is displayed, the margin level will be reset.

JOG/SHTL key
RAM SCRUB key

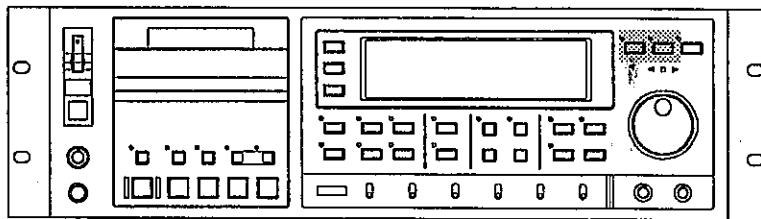

■ **JOG/SHTL (Jog/Shuttle) key**

In normal operation, the LED will light if this key is pressed once and the JOG/SHTL mode will switch on.
 To cancel the JOG/SHTL mode, press any other tape handling button such as STOP.
 In the JOG/SHTL mode, the JOG SPEED can change from 1/2 to 1 times or the playback SHUTTLE SPEED from 1/2 to 16 times with the JOG or SHUTTLE dials.

<NOTE>

In the JOG/SHTL mode, RAM is not used but the tape signal is read in real time.

■ **RAM SCRUB key**

The RAM SCRUB mode will turn on when this key is pressed once. The LED will change from blinking to constant lighting.
 To cancel the RAM SCRUB mode, either switch on the JOG/SHTL mode or press any one of the tape transport button such as the PLAY or STOP button.

Outstanding features of RAM SCRUB

When operating the JOG dial, cueing is possible with accuracy less than one frame in the 1 time playback speed.
 When operating the SHUTTLE dial, the playback speed will change with the dial position (rotating angle) and thus, cueing is possible such as in conventional analog recorders.

In the RAM SCRUB mode, JOG and SHUTTLE playback speeds can be changed 0~1 times with the JOG and SHUTTLE dials.

LED indications when RAM SCRUB is on are as shown below.

Light	RAM SCRUB operation is possible or is being executed.
Blinking	AUDIO DATA is being read into the RAM and RAM SCRUB is on standby.

<NOTES>

- * When this LED is blinking, always check that it has changed to a constant light before proceeding to next step.
- * In the RAM SCRUB mode, RAM SCRUB will be carried out within the ±3.5 sec. range, centered around the point where the key was pressed.
- * Refer to chapter 4 (pages 4 - 19 and 26), for details on RAM SCRUB operation.

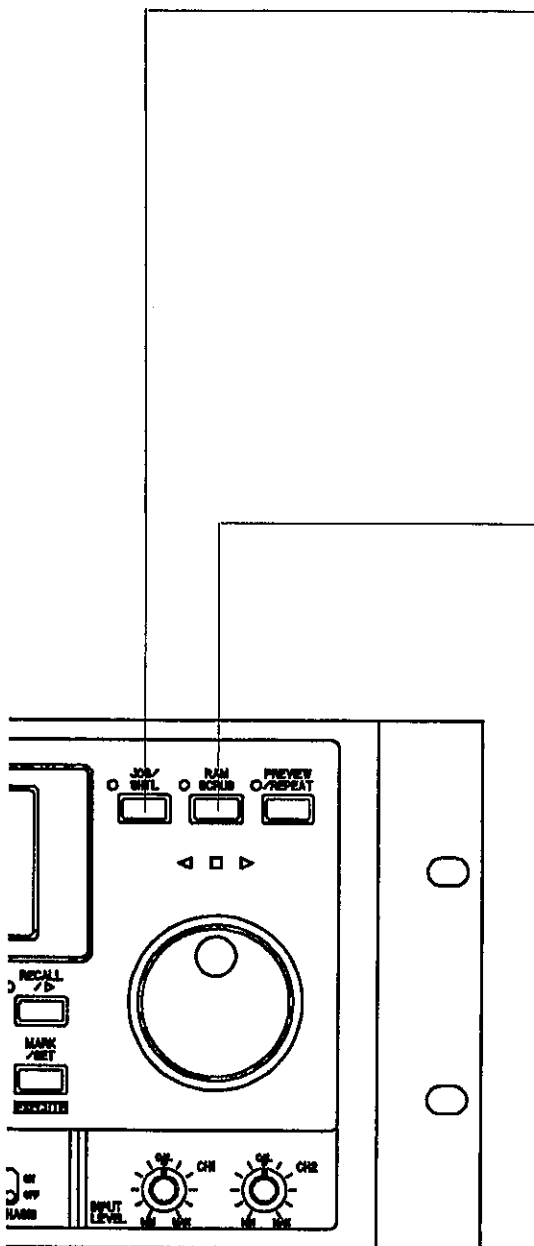

- PREVIEW/REPEAT key
- JOG/SHTL lamp
- JOG dial
- SHUTTLE dial

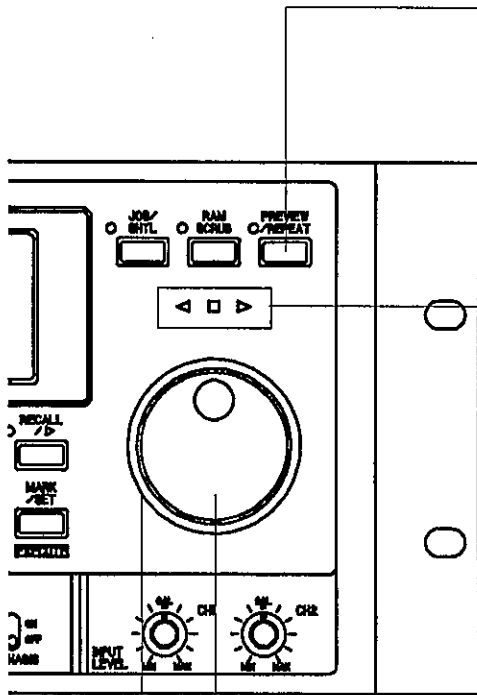
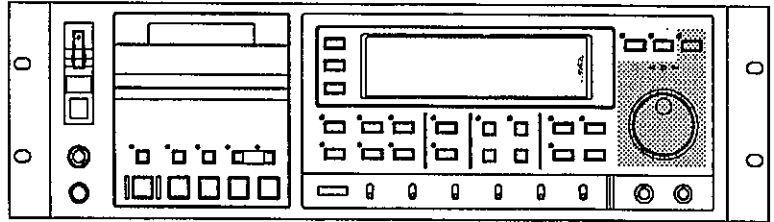

■ **PREVIEW/REPEAT key**

In the INSTANT START mode, the PREVIEW mode is entered when this key is pressed, RAM REHEARSAL playback is executed once (LED is lit), and the PREVIEW mode will be canceled (LED is extinguished).

If this key is pressed again during RAM REHEARSAL playback, the D-25 will enter the REPEAT mode and continue repeating (LED blinks) until RAM REHEARSAL playback is canceled.

To cancel this REPEAT mode, press any of the tape control buttons such as PREVIEW/REPEAT or STOP.

* Refer to chapter 4 (page 4 - 27), for details on PREVIEW/REPEAT.

■ **JOG/SHTL lamp**

These lamps will be lit when this recorder is operating in the following modes:

■	Transport is in the RAM playback or pause modes.
<	Cueing in the rewind direction.
>	Cueing in the forward direction.

■ **JOG dial (inner dial)**

JOG operation while in the JOG/SHTL and RAM SCRUB modes, and moving the RAM REHEARSAL START point are possible.

Also, it is possible to input numerical data in the data edit mode. The setup menu can be selected in the SETUP mode.

* Refer to chapter 4 (page 4 - **), for details on JOG/SHTL and RAM SCRUB modes.

* Refer to chapter 7, for details on DATA EDIT and chapter 9, for the SETUP mode.

■ **SHUTTLE dial (outer dial)**

SHUTTLE operation in the JOG/SHTL and RAM SCRUB modes is possible.

* Refer to chapter 4 (pages 4 - 18 and 4 - 19), for details on JOG/SHTL and RAM SCRUB modes.

MEM LOC key
RECALL/> key

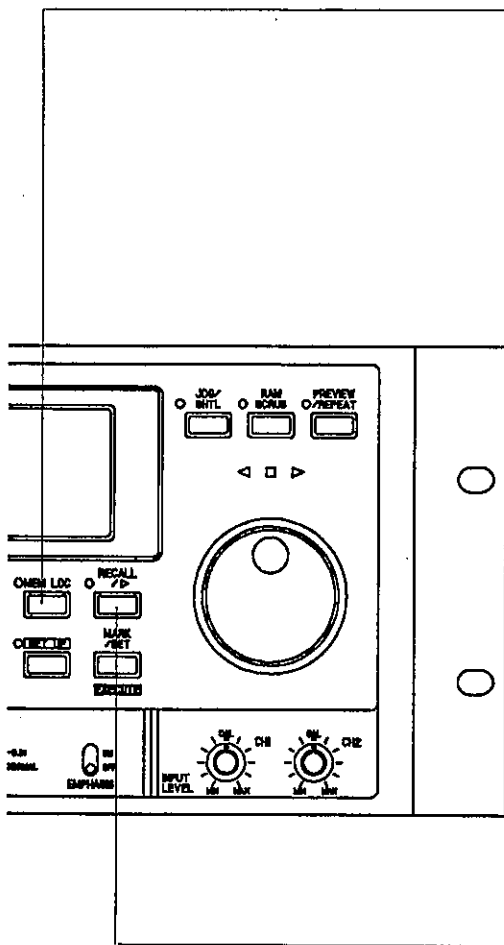
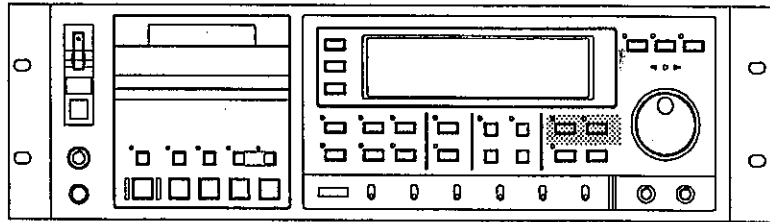

■ **MEM LOC (Memory Locate) key**

When this key is pressed, the tape will start locating to the time in the memory (A-TIME, TC, etc.) and pause at this time point. LED will be lit during execution of locate but extinguish at completion.

If the PLAY button is pressed during a locate operation, the D-25 will enter LOCATE & PLAY and, upon completing locate, will enter play. This works the same in the INSTANT START mode.

If this key is pressed after switching on the RECALL/> key, memory time can be edited.

<NOTE>

If nothing is registered in memory locate, the D-25 will locate to [00H:00M:00S:00F].

- * Refer to chapter 4 (page 4 - 22), for details on Memory Locate.
- * Refer to chapter 7, for details on Data Edit.

■ **RECALL /> (character shift) key**

When this key is pressed during normal operation, the data edit mode will switch on and, depending on the keys that are subsequently pressed, data can be edited. During data editing, the editable digit (point) can be moved.

If the RECALL/>key, then the next key is pressed, respective data can be edited.

RECALL/> → CHASE:	CHASE OFFSET TIME can be edited.
RECALL/> → TC GEN:	GENERATE TIME of the TC GENERATOR can be edited.
RECALL/> → MEM LOC:	MEMORY TIME can be edited.
RECALL/> → S-ID WHITE:	NEXT P NO can be input.

- * Refer to chapter 7, for details on Data Edit.
- * Refer to chapter 7, for details on input of NEXT P NO.

SET UP key
MARK/SET key
CHASE key

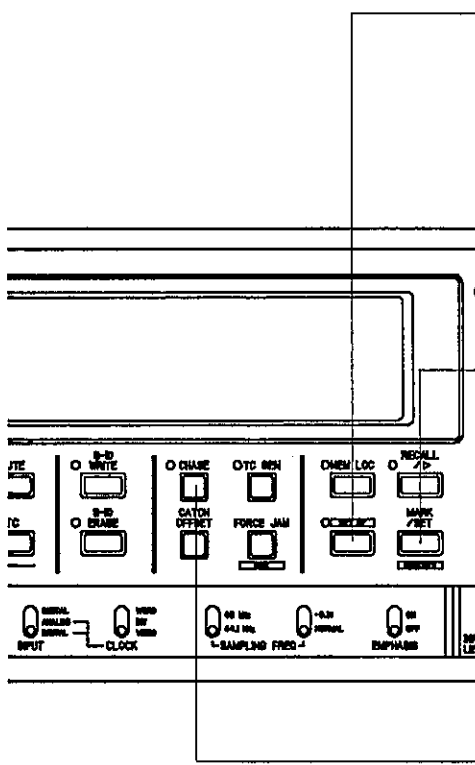
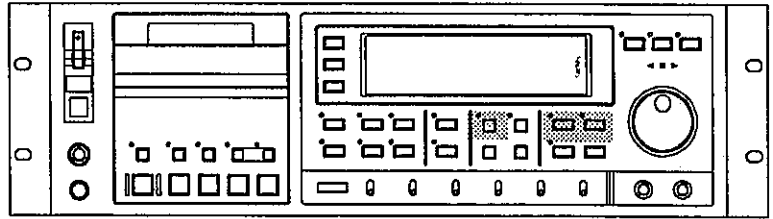

■ **SETUP key**

Press this key to enter the setup mode. The LED will light. Press the SETUP mode key to find the desired setup which is selected in a forward direction. To exit from the setup mode, press the QUIT or DISP TIME key.

* Refer to chapter 9, for details on setting the SETUP mode.

■ **MARK/SET/EXECUTE key**

When this key is pressed in the normal display mode, the time at the point where the key was pressed (A-TIME or TC) will be stored in the memory as the locate memory data.

When this key is pressed in the setup mode and data edit mode, setup content thus selected or the edited data will be established.

* Refer to chapter 9, for details on the setup mode and chapter 7, for the data edit mode.

■ **CHASE key**

Generally, when this key only is pressed, the chase mode is alternately switched on or off.

When the D-25 is used with an external sync, if the chase mode is switched on, the recorder will run by locking with the external time code. CHASE LOCK will be lit in the display when thus CHASE LOCKED.

If this key is pressed after switching on the RECALL key, the D-25 will enter the data edit mode for CHASE OFFSET TIME. To exit from the data edit mode, press either the QUIT or DISP TIME key.

<NOTE>

This key will not function when the INSTANT START mode is ON.

* Refer to chapter 7, for details on editing of CHASE OFFSET TIME.

* Refer to chapter 8, for details on external sync.

TC GEN key
FORCE JAM/QUIT key
CATCH OFFSET key

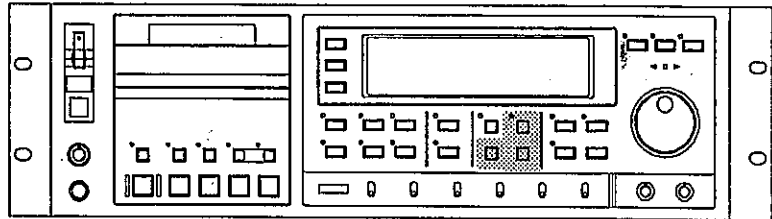

■ **TC GEN (Time Code Generator) key**

Normally, if this key only is pressed, the internal generator can be alternately switched on or off.

If this key is pressed after switching on (LED is lit) the RECALL/> key, the D-25 will enter the data edit mode for GENERATOR TIME. To exit from the data edit mode, press either the QUIT or DISP TIME key.

- * Refer to chapter 6, for details on TC GEN key operation.
- * Refer to chapter 7, for details on GENERATOR TIME editing.

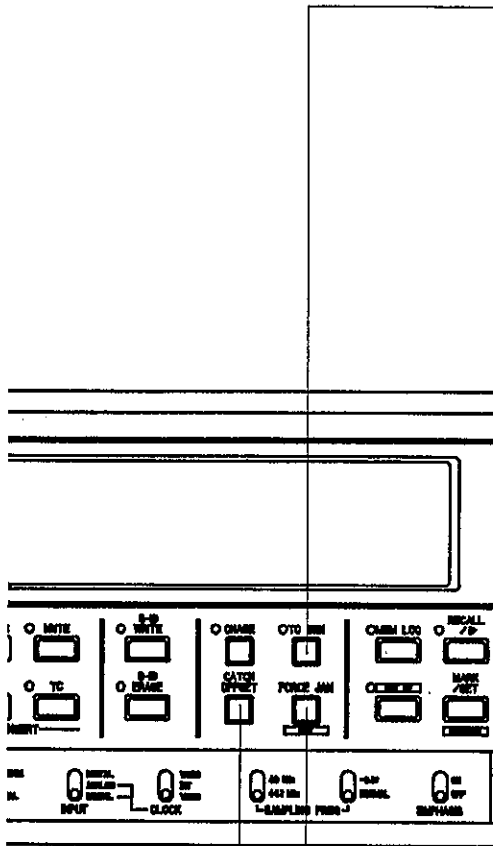

■ **FORCE JAM/QUIT key**

Normally, when using the recorder with external sync input of REF-TC, the INT GENERATE TIME can be matched to the REF-TC by pressing this key. If this key is pressed in the setup or data edit mode, the D-25 will exit from these modes and return to the normal display mode.

■ **CATCH OFFSET key**

Normally, when using the D-25 under external sync by input of REF-TC, the REF-TC at the point when this key was pressed and OFFSET of REP-TC will be stored in memory as CHASE OFFSET TIME.

- * Refer to chapter 7, for details on editing of CHASE OFFSET TIME.

S-ID WRITE key
S-ID ERASE key

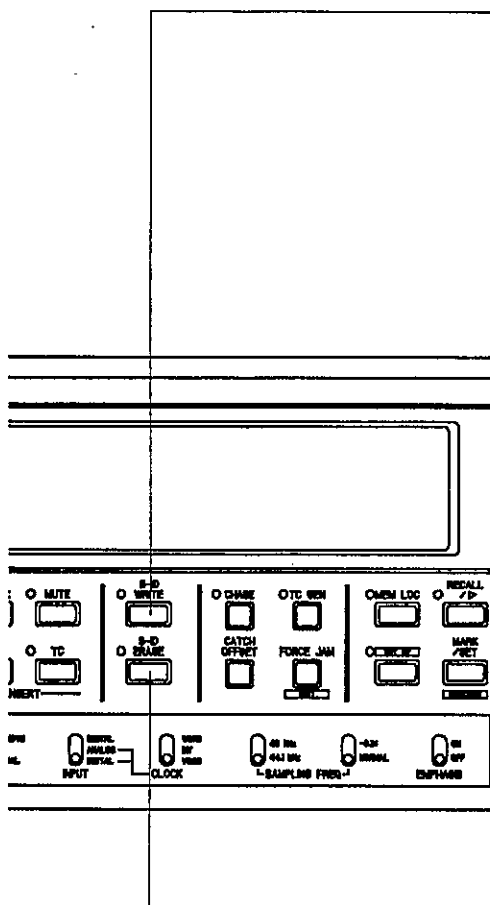
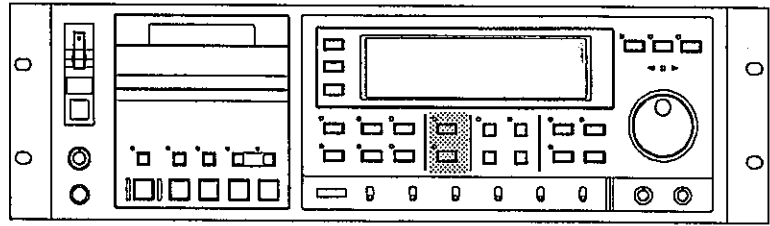

■ S-ID WRITE (Start ID Write) key

This key is pressed for recording S-ID/P-NO.
When this key is pressed after the RECALL/> key is switched on, it will be possible to input the NEXT P-NO.
The S-ID/P-NO can be recorded by pressing this key, while in the playback and recording modes after the NEXT P-NO is input and then the MARK/SET key is pressed.

<NOTES>

- * In the playback mode, a S-ID can be recorded only when the ASSEMBLE mode is off or the TC INSERT key is on. An S-ID will not be recorded in any other mode.
- * This will not function if the cassette erase protection hole is open.
- * Refer to chapter 5, for details on S-ID recording.

■ S-ID ERASE (Start ID Erase) key

When this key is pressed in the STOP or PAUSE modes, if an S-ID exists within two seconds after this key was pressed, that S-ID will be erased.

<NOTES>

- * Erase is possible only when the ASSEMBLE mode is off or the TC INSERT mode only is on. Erase is not possible in any other mode.
- * This will not function if the cassette erase prevention hole is open.
- * Refer to chapter 5, for details on erasing of S-ID.

CONFIDENCE MONITOR key
AUDIO MONITOR key
MUTE key

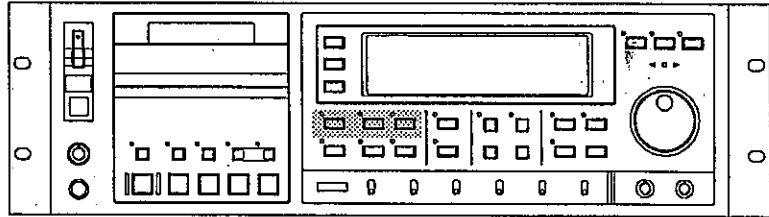

■ **CONFIDENCE MONITOR key**

The CONFIDENCE MONITOR mode is alternately switched on or off by pressing this key.
 Recording by simultaneous monitoring of the input signal is possible when the CONFIDENCE MONITOR mode is switched on.

<NOTE>

When the INSTANT START and AUTO CUE modes are on, these modes will be automatically switched off if the CONFIDENCE MONITOR is switched on.

* Refer to chapter 4 (pages 4 - 6 and 4 - 12), for details on the CONFIDENCE mode.

■ **AUDIO MONITOR key**

INPUT MONITOR/REPRO MONITOR of AUDIO can be alternately switched by pressing this key. States of the INPUT MONITOR or REPRO MONITOR will be indicated by the LED as follows:

LED:off	REPRO MONITOR (tape playback)
LED:on	INPUT MONITOR

The D-25 will be in REPRO MONITOR at switch on of power.

<NOTE>

Audio tracks L and R cannot be independently INPUT MONITORED by this recorder alone.

* Refer to chapter 4 (page 4 - 4 ~), for details on operation.

■ **MUTE key**

In the playback mode, AUDIO OUT will be muted as long as this key is pressed. However, MONITOR OUT and PHONES OUT will not be muted and thus can be used for monitoring. There will be mute recording of DATA 0 during AUDIO recording as long as this key is pressed.

* Refer to chapter 4 (page 4 - 13), for details on operation.

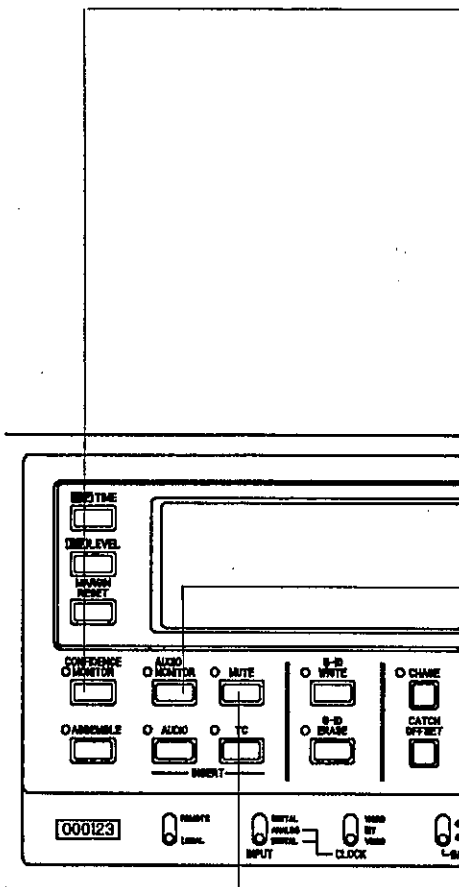

ASSEMBLE key
TC INSERT key
AUDIO INSERT key

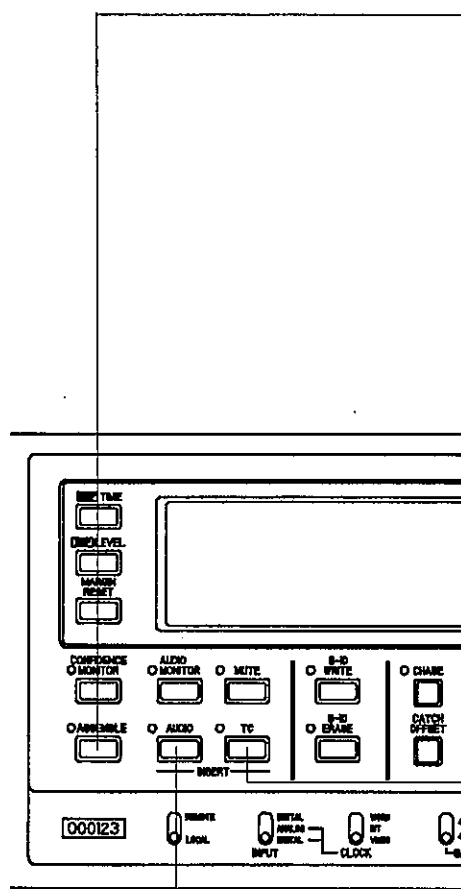
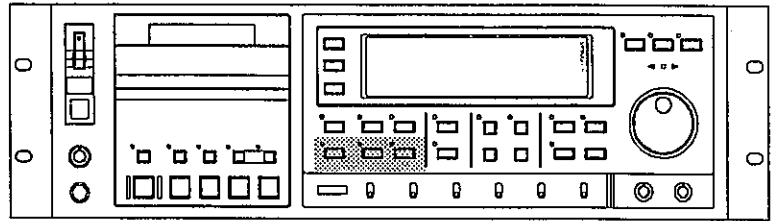

■ **ASSEMBLE key**
 The ASSEMBLE mode will alternately switch on or off by pressing this key. At the same time, AUDIO/TC INSERT can also be switched on or off.
 When both AUDIO and TC INSERT keys are switched on, the ASSEMBLE mode will also switch on simultaneously.
 INSERT or ASSEMBLE modes can be distinguished by the LED as follows:

LED:off:	INSERT mode
LED:on:	ASSEMBLE mode

<NOTE>
 Under ASSEMBLE recording, the continuity of AUDIO and TIME CODE prerecorded by punch out will be lost.

* Refer to chapter 4 (pages 4 - 6 and 4 - 12), for details on method of utilization.

■ **TC (Time Code) INSERT key**
 The time code insert mode will alternately switched on or off. In the off tape mode, it will simultaneously switch on or off together with the AUDIO INSERT key.
 If this key is switched off in the ASSEMBLE mode, TC INSERT and ASSEMBLE modes only will switch off.

* Refer to chapter 6, for details on the operating method.

■ **AUDIO INSERT key**
 Audio insert mode is alternately switched on or off. In the off tape mode, it simultaneously turns on or off with the TC INSERT key.
 If this key is switched off in the ASSEMBLE mode, AUDIO INSERT and ASSEMBLE modes only will be switched off.

* Refer to chapter 4 (page 4 - 4 ~), for details on the operating method.

INPUT LEVEL knob
EMPHASIS switch
SAMPLING FREQ switch

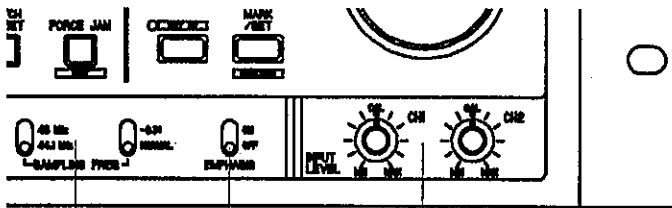
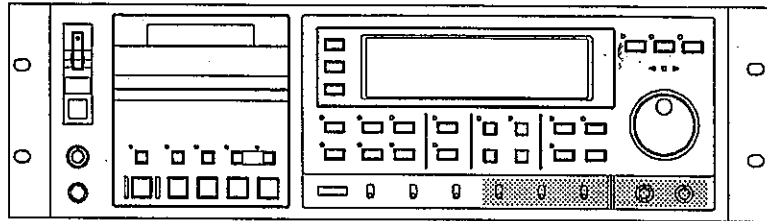

■ **INPUT LEVEL knob**

This controls the analog audio signal (CH 1, CH 2) input levels. The knob center click (CAL) position is the standard recording level.

* Refer to chapter 4 (page 4 - 7), for details on the operating method.

■ **EMPHASIS switch**

Emphasis on or off when recording analog audio signals is selected with this switch. During playback, the D-25 will automatically play back according to the emphasis information on the tape. If the emphasis information and switch setting do not match, [EMPHASIS] will blink in the display but will change to a constant light if the switch is changed. When recording digital audio signals, the D-25 will be set automatically the same as the input digital signal. Consequently, there is no need to set the switch. Playback is automatic the same as for analog audio signals. The display [EMPHASIS] will blink if emphasis information and switch setting do not match but it will change to constant lighting if the switch is changed.

■ **SAMPLING FREQ selecting switch**

Sampling frequency during analog recording is selected with this switch. The selected frequency will be shown in the display. Digital audio signal recording is automatically set by its status signal.

48kHz-NORMAL:	Set to FS 48kHz
44.1kHz-NORMAL:	Set to 44.1kHz
48kHz-0.1%:	Set to 47.952kHz
44.1kHz-0.1%:	Set to 44.056kHz

<NOTE>

FS 44.056kHz will function internally as 44.1kHz and FS 47.952kHz as 48kHz.

CLOCK switch

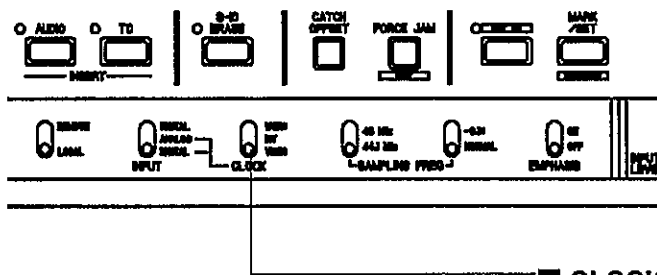
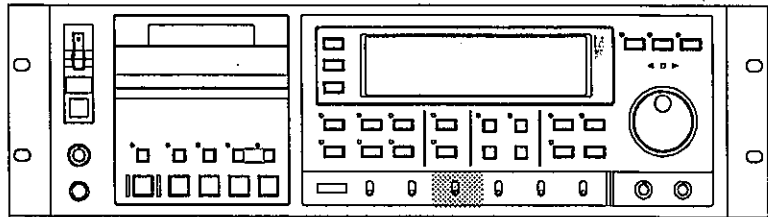

■ **CLOCK switch**

This is for selecting this recorder's operating clock between internal clock (INT) and external sync (WORD/VIDEO).

WORD:

The operating clock will lock onto the EXTERNAL WORD CLOCK IN clock.
Should there be no input of WORD CLOCK or if it exceeds the operating range, the D-25 will automatically switch to INTERNAL. In this case, lighting of [CLOCK LOCK] and [EXT CLOCK] or blinking of [CLOCK LOCK] in the display indicates the following.

[EXT CLOCK]/[CLOCK LOCK] is lit.:
The D-25 is locked to WORD CLOCK.

[CLOCK LOCK] is blinking.:
The D-25 automatically enters the INTERNAL CLOCK mode.

INT:

The operating clock is locked onto the internal reference clock and [CLOCK LOCK] is lit in the display.

VIDEO:

Composite, frame pulse and field pulse signals input to the VIDEO/DAT-F INPUT connector is automatically locked on. The frame rate, however, must match with the SETUP mode FRAME SELECT. Indication of the following when the display [EXT CLOCK], [CLOCK LOCK] are lighted or blinking:

[EXT CLOCK] and [CLOCK LOCK] are lit.:
It is locked on the VIDEO CLOCK.

[EXT CLOCK] and [CLOCK LOCK] are blinking.:
Either VIDEO CLOCK is exceeding the operating range or there is no CLOCK input.

INPUT switch
REMOTE/LOCAL switch

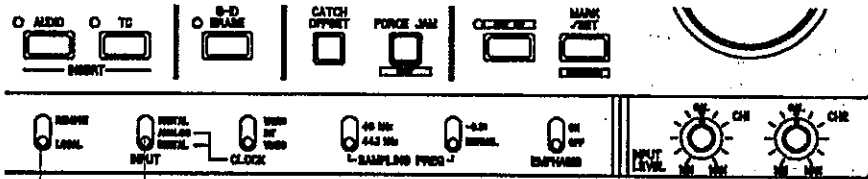
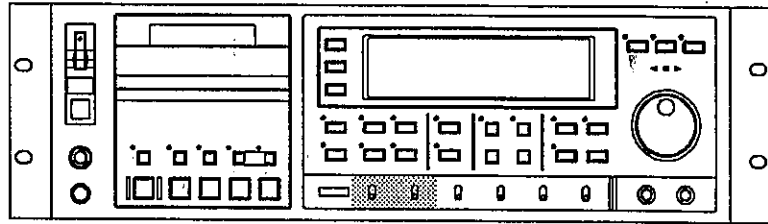

■ **INPUT selecting switch**

Input to the recorder can be selected for DIGITAL or ANALOG with this switch.

DIGITAL	This is the DIGITAL IN mode. Clock operation in this mode will be locked by the DIGITAL IN BIT CLOCK. If there is no digital data input or there is no input to lock on, the D-25 will automatically enter the ANALOG IN mode.
ANALOG CLOCK	This is the ANALOG IN mode. Clock operation in this mode will be determined by the CLOCK switch setting (VIDEO/IN/WORD).
DIGITAL CLOCK	This is the DIGITAL IN mode. Clock operation in this mode will be determined by the CLOCK switch setting (VIDEO/INT/WORD). If there is an error in the input or there is no input at all, the D-25 will automatically enter the ANALOG IN mode.

■ **REMOTE/LOCAL selector switch**

This selects how the D-25 is controlled.

REMOTE	External remote control mode such as from RS-422. The recorder will be panel locked. After switching and any other button is pressed, [rEmotE] will appear in the display for several seconds and then return to normal display.
LOCAL	Control is possible from the front panel of the recorder. External remote control is not possible.

- * Control is possible from 37P-REMOTE regardless to the switch setting.
- * In the setup mode, on or off of remote panel lock can be selected.

3-2. Display Section

The display of this recorder shows a variety of information such as A-TIME, TC, DATE, GENERATOR TC, in addition, error and signal levels. Also, data can be edited on the display. In regular operation, the following information can be displayed by the DISP TIME and DISP LEVEL keys. This will be referred to as the normal display in this manual.

■ Normal Display

When the DISP TIME key is pressed, the following information will be alternately displayed:

REP-TC Display

Playback time code information recorded on the tape will be displayed.

When leaving the plant, the D-25 is set to display REP-TC.

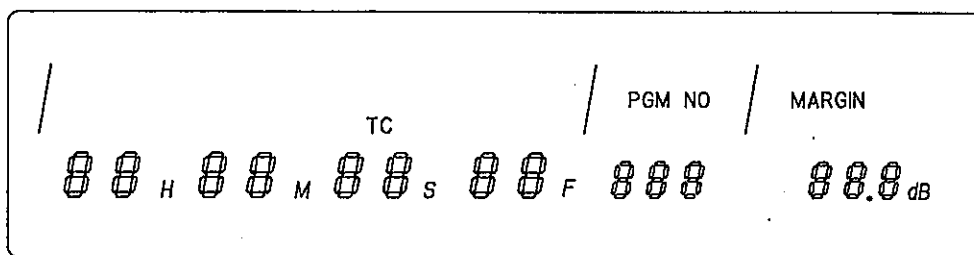

A-TIME Display

A-TIME information on the tape.

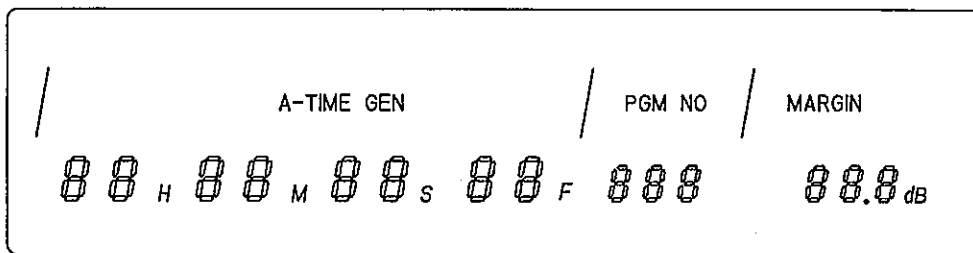

DATE Display

DATE information on the tape.

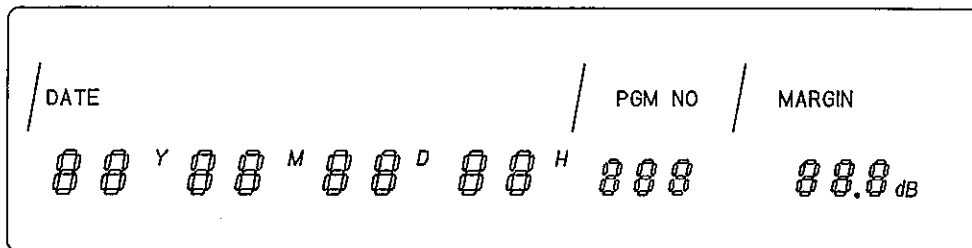

GEN Display

TIME information of the INTERNAL GENERATOR.

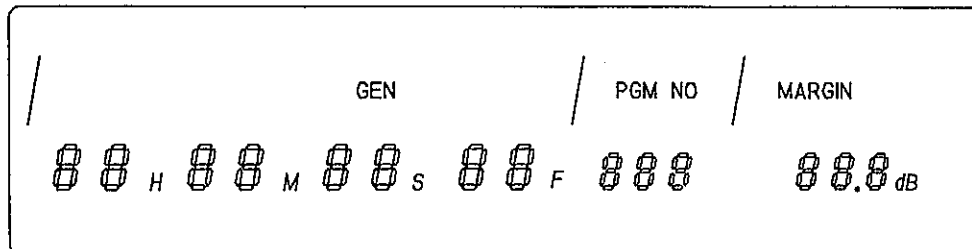

UB Display

Users Bit information on the tape.

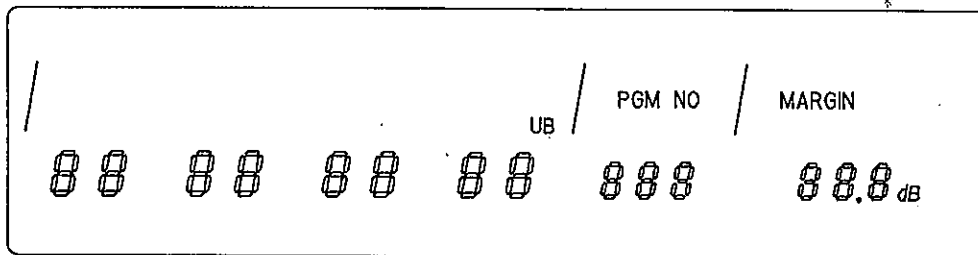

REF Display

TIME information of the external REFERENCE TC.

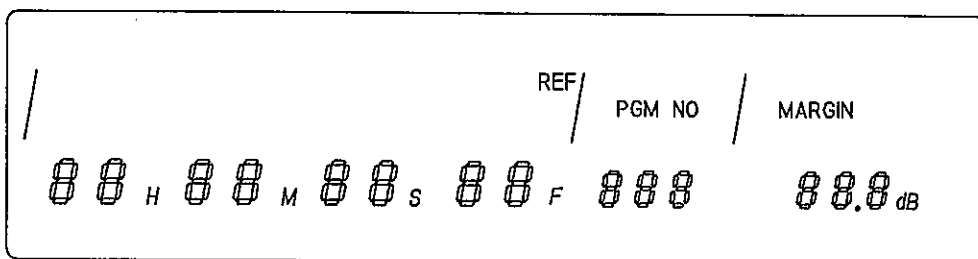

OFFSET Display

OFFSET information of the REP-TC and REF-TC.

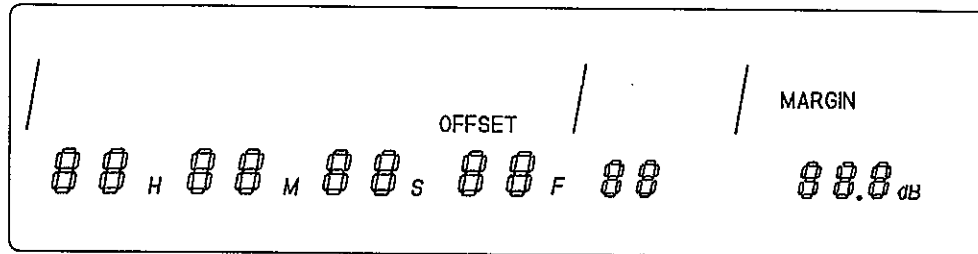

■ **Normal Display**

When the DISP LEVEL key is pressed repeatedly, the following information is alternately displayed.

MARGIN Display

Input level margin.

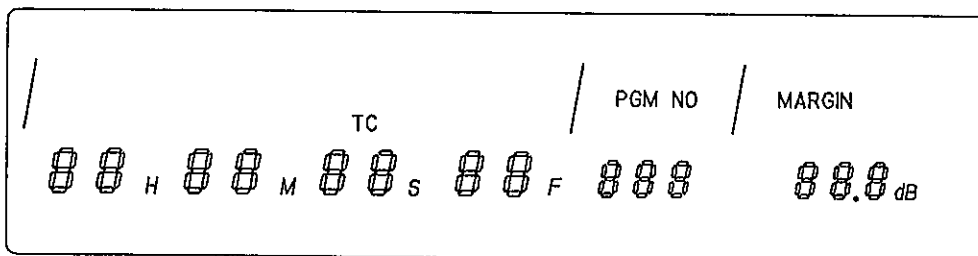

1 CH LEVEL Display

Audio level of CH 1 (L).

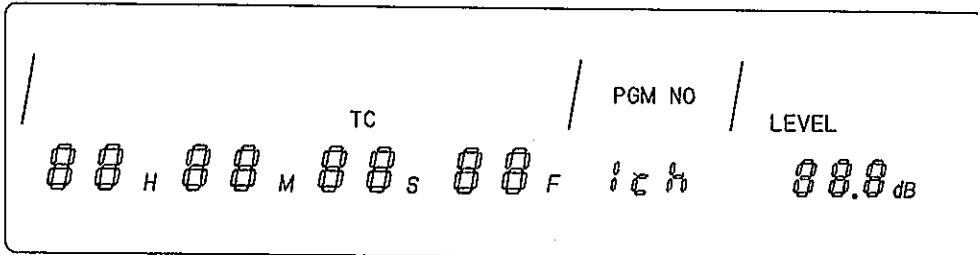

2 CH LEVEL Display

Audio level of CH 2 (R).

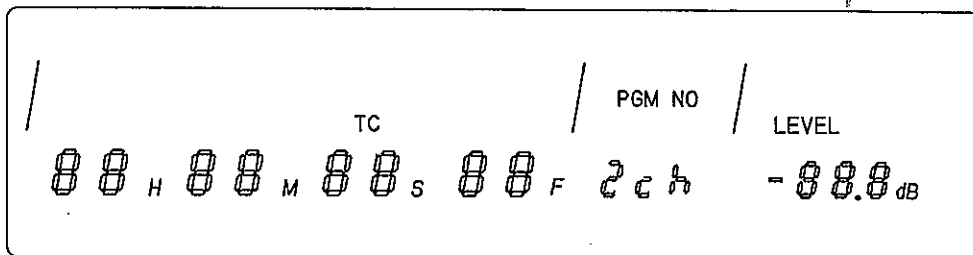

ERROR RATE Display

Error rate of CH 1 and CH 2.

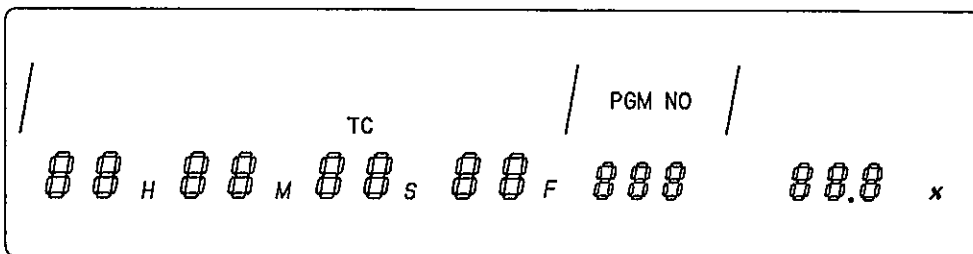

FRAME RATE Display

Frame rate of REP-TC.

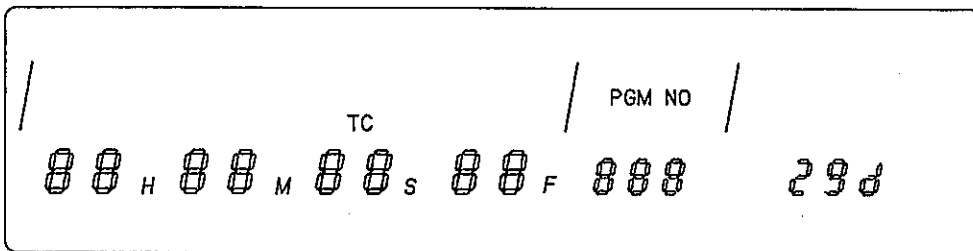

■ **Other Normal Displays**

[OP En] Display

When the cassette tray is open with no tape inserted or if the tray is opened, this message will be displayed when the OPEN/CLOSE key is pressed.

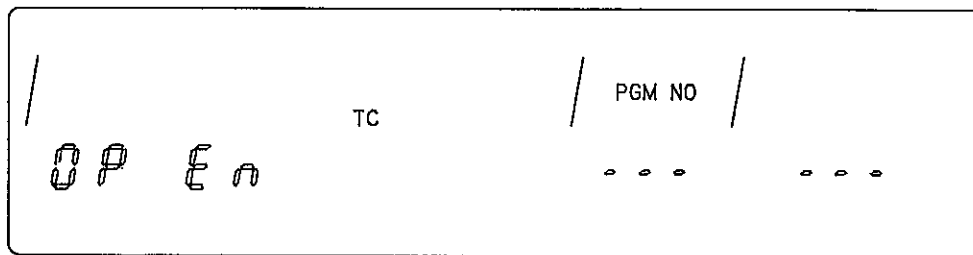

[bE GIn] Display

Tape is completely wound in the rewind direction.

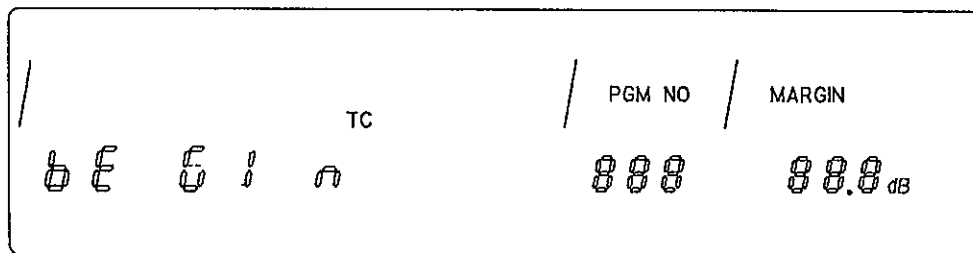

[En d] Display

Tape is completely wound in the forward direction.

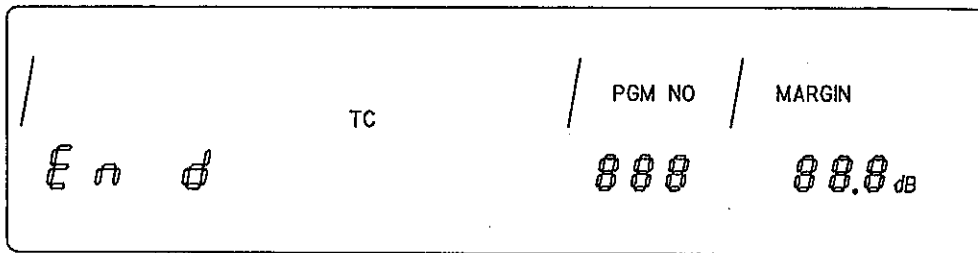

■ Data Edit Mode Display

Use this display for editing various data which is displayed when the various keys listed below are pressed after pressing the RECALL/> key.

To exit from the data edit mode, press either the QUIT key or DISP TIME key.

RECALL/> → MEM LOC

Memory locate TIME data can be edited.

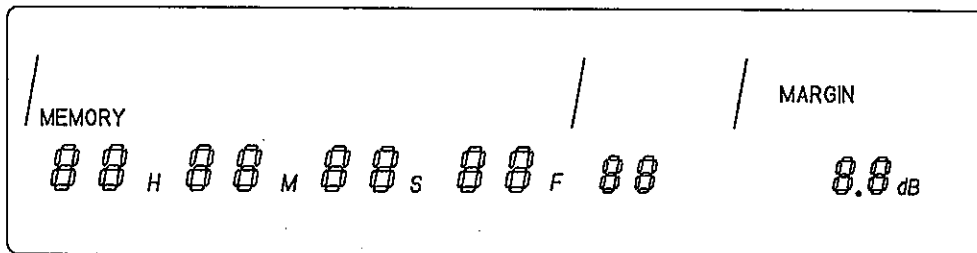

RECALL/> → TC GEN

TIME data of the internal generator can be edited.

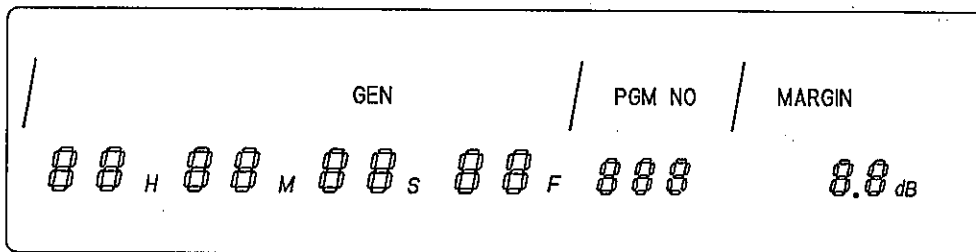

RECALL/> → CHASE

The CHASE OFFSET data can be edited.

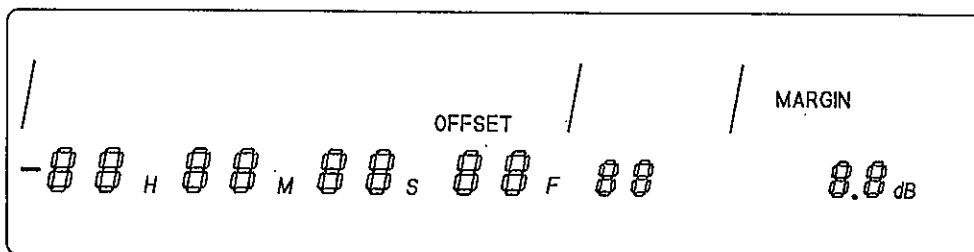

RECALL/> → S-ID WRITE

NEXT P-No for recording an S-ID can be input.

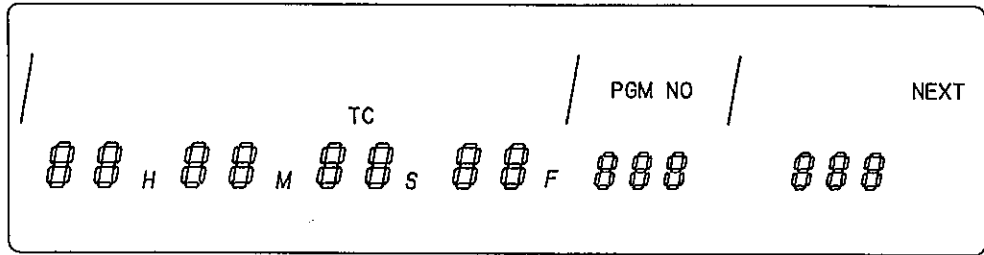

■ SETUP Mode Display

When the SETUP key is pressed, the D-25 will change to the SETUP mode display for the setup process. When power is switched on, version display (001) will be shown.

The SETUP key and JOG dial are used to select the SETUP mode items. To exit from the SETUP mode display, press the QUIT or DISP TIME key.

* Refer to chapter 9 for details.

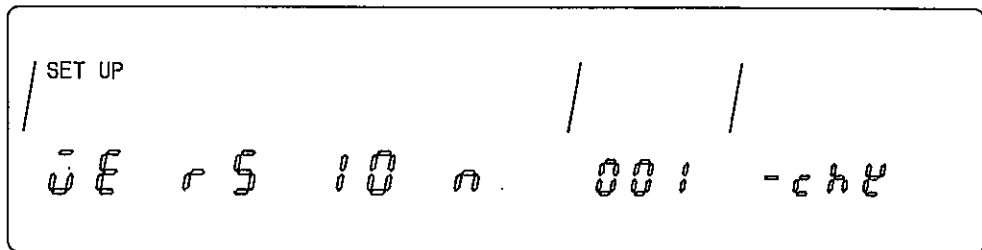

■ Normal Display

Message Indication

Setup conditions and sub ID, etc. of this recorder will be displayed.

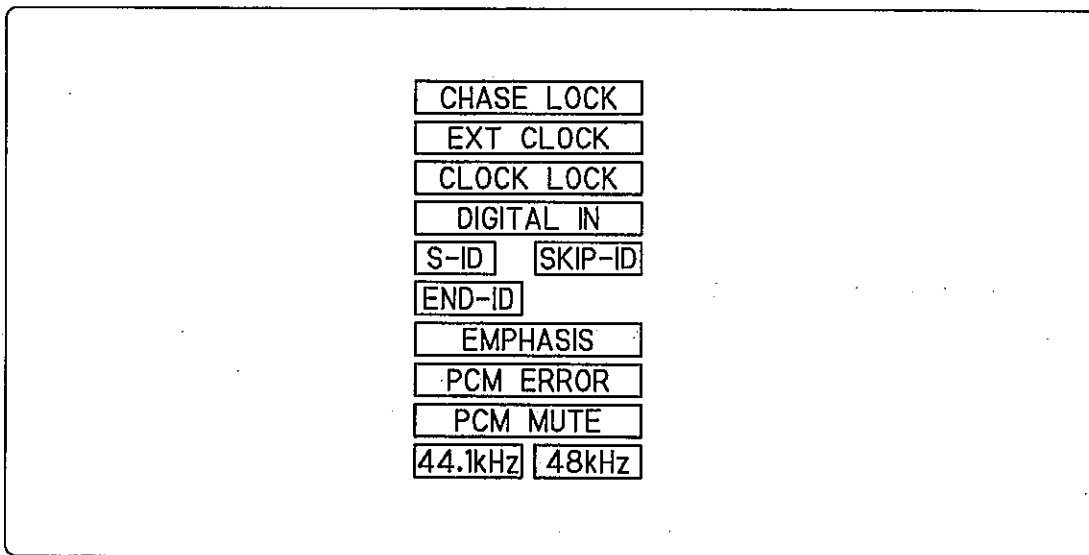

[EXT CLOCK]

When in the WORD or VIDEO CLOCK setting, this will be lit when locked, and will fast blink when not locked or when EXT CLOCK is being input.

[CLOCK LOCK]

This is lit when the MASTER CLOCK is locked according to yje INTERNAL or EXT CLOCK setting.

[DIGITAL IN]

This is lit when the INPUT selector switch is set to DIGITAL and becomes locked to the digital signal.

[S-ID]

Indicates an S-ID recorded on the tape. This is lit during recording of S-ID.

[SKIP ID]

Displays the SKIP-ID recorded on the tape.

<NOTE>

This recorder cannot record or erase a SKIP-ID.

[END-ID]

Displays the END-ID recorded on the tape.

<NOTE>

This recorder cannot record or erase the END-ID.

[TOC-ID]

Displays any TOC-ID recorded on the tape.

<NOTE>

This recorder cannot record or erase the TOC-ID.

[EMPHASIS]

This is lit when emphasis is on and extinguished when off.

If EMPHASIS is blinking during analog input, this is an indication that there is a difference between emphasis information on the tape and the switch setting.

If EMPHASIS is blinking during digital input, this is an indication that emphasis information on the tape is different from the DIGITAL IN emphasis information.

In either case, emphasis information on the tape will be automatically set except for RECORD and INPUT MONITOR.

[PCM ERROR]

This will not be lit under normal playback but be lit when the block error rate exceeds 10 %.

[PCM MUTE]

This will light when there are many errors and being muted and will extinguish when playback is normal.

<NOTE>

Immediately after playing the tape, this will stay lit until tape travel becomes stable. This is not a malfunction.

[44.1kHz] [48kHz]

FS in operation will be displayed.

During analog input, FS information on the tape will have priority except when recording and will automatically be set to FS in the tape information. However, at recording it will change over by the FS switch setting. Also, if there is a difference between the tape FS information and the switch setting, this will be indicated by blinking.

During digital input, FS information of the DIGITAL IN will have priority over the tape FS information and FS set by the FS switch..

If there is a difference between FS information of DIGITAL IN and FS information on the tape, the tape playback sound will be muted.

[REF 12 18 20]

The currently set reference level will be displayed (initial setting is 12dB). Reference level can be changed in the SETUP mode.

* Refer to chapter 9 "SETUP mode" for details.

3-3. Rear Panel Section

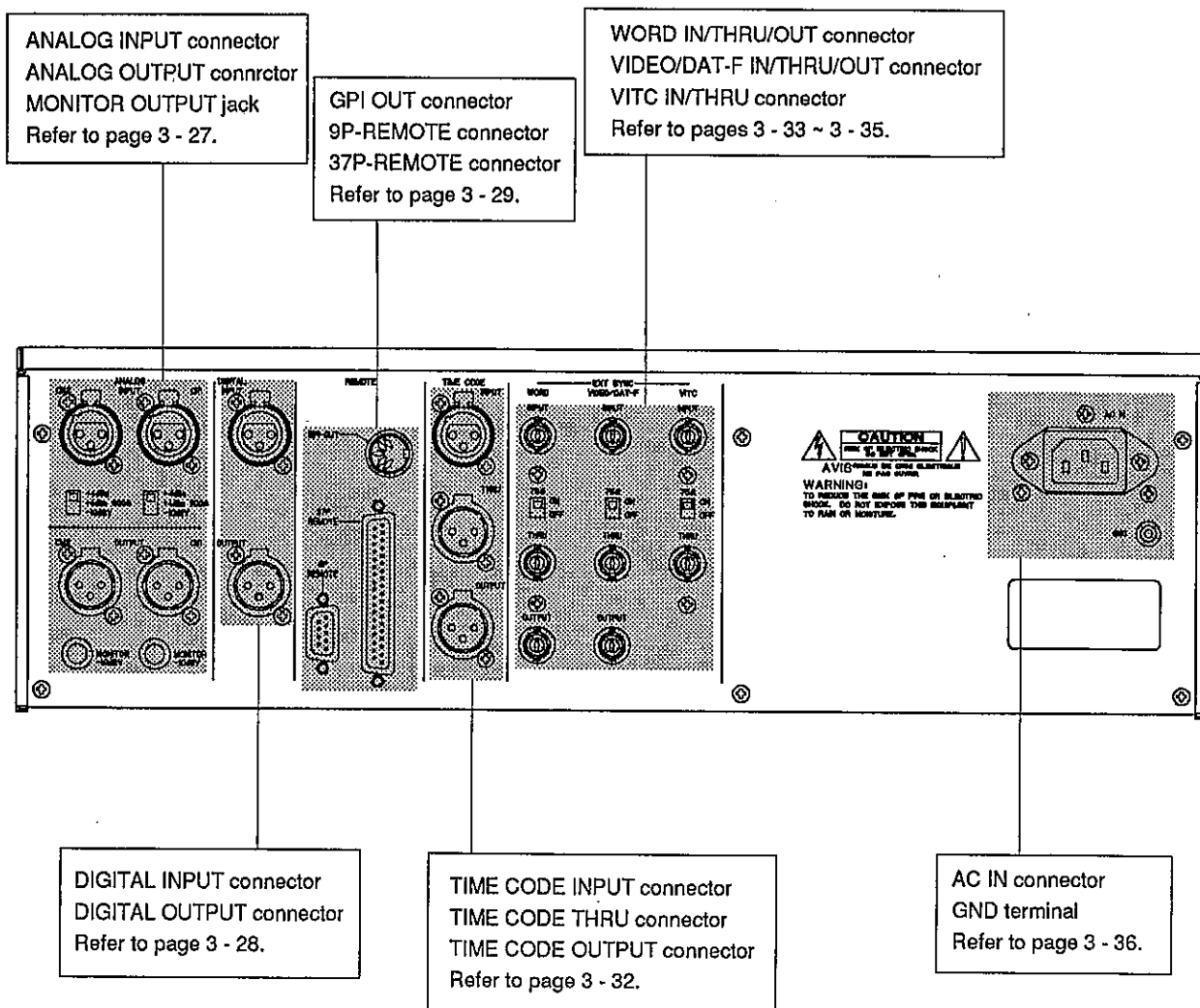

ANALOG INPUT connectors

Standard Input level selector switch

ANALOG OUTPUT connectors

MONITOR OUTPUT jacks

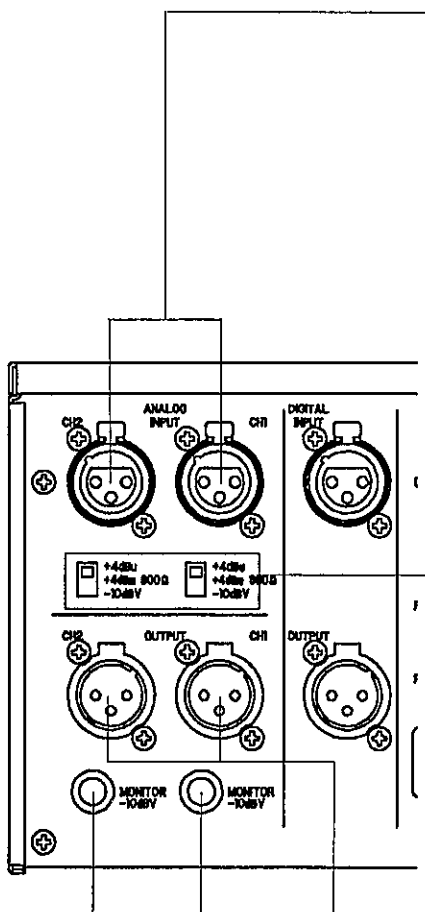
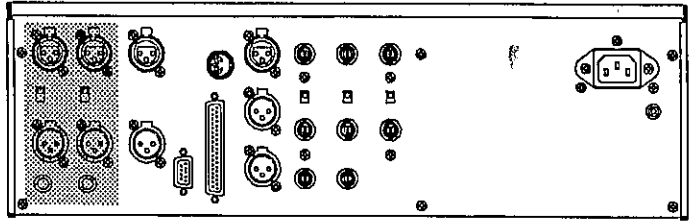

■ **ANALOG INPUT (Analog audio signal) connector**

CH 1 (L) and CH 2(R) analog audio signals are input (BALANCE).

Connector: XLR-3-31 type

(Pin 1: GND, Pin 2: HOT, Pin 3: COLD)

Standard input level: +4dBu, +4dBm/600Ω, -10dBV
3 stage selector.

■ **Standard Input level selector switch**

Selects standard level for CH 1 (L) and CH 2 (R) analog audio signals. Standard input levels can be switched for +4dBu, +4dBm and -10dBV.

■ **ANALOG OUTPUT (Analog audio signal) connector**

CH 1 (L)/CH 2 (R) analog audio signals are output here (BALANCE).

Connector: XLR-3-32 type

(Pin 1: GND, Pin 2: HOT, Pin 3: COLD)

Standard output level: +4dBu

■ **MONITOR (output) jack**

CH 1 (L) and CH 2 (R) monitor analog audio signals are output here (UNBALANCE).

Connector: φ 6 phone jack

Standard output level: -10dBV

DIGITAL INPUT connector
DIGITAL OUT connector

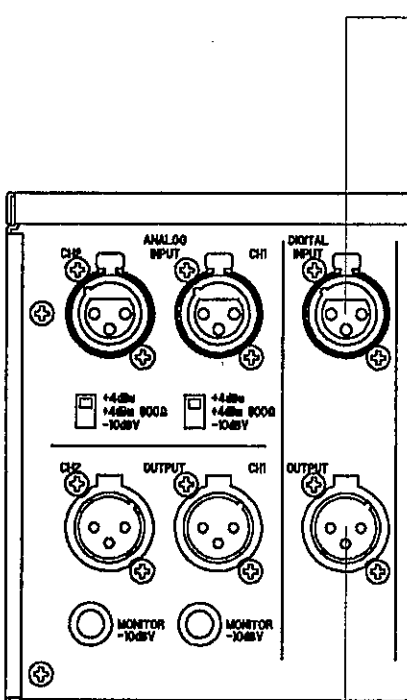
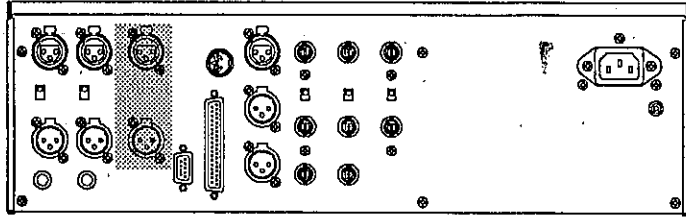

■ **DIGITAL INPUT (Digital audio) connector**
Digital audio signals in the AES/EBU and CONSUMER formats are input here.

Connector: XLR-3-31 type
(Pin 1: GND, Pin 2: HOT, Pin 3: COLD)

■ **DIGITAL OUTPUT (Digital audio) connector**
Digital audio signals in the AES/EBU and CONSUMER formats are output here.

Connector: XLR-3-32 type
(Pin 1: GND, Pin 2: HOT, Pin 3: COLD)

9P-REMOTE connector
 GPI OUT connector
 37P-REMOTE connector

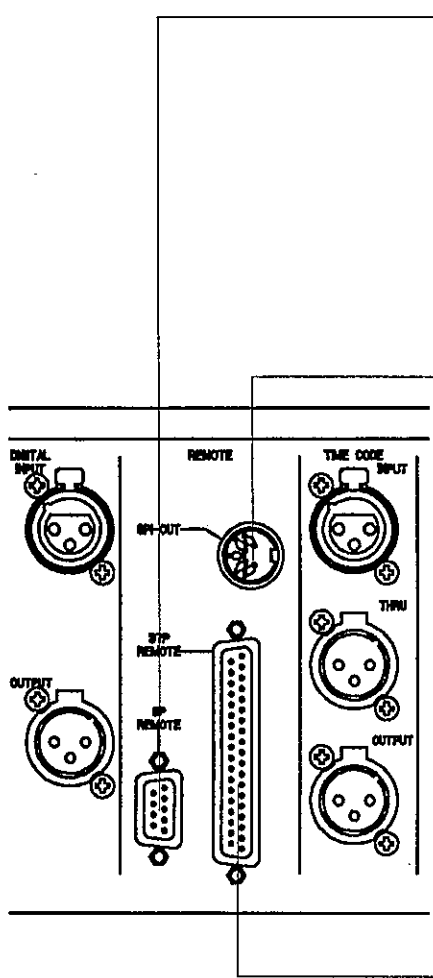
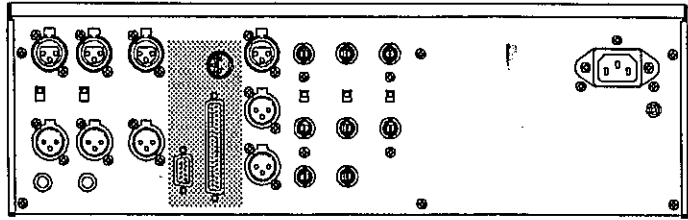

■ **9 PIN REMOTE connector**

Connector complying to the RS-422 specification for the remote connector.
 Used for controlling this recorder from other equipment (D-30, editors, etc.) connected to this recorder.

Connector: D-SUB 9 pin

■ **GPI OUT connector**

This is provided for function expansion in the future.

Connector: DIN 5 pin
Output: Open collector (+5V, 10kΩ pull up)
 Low active (60ms pulse width)

■ **37 PIN REMOTE connector**

Connector for receiving the 37 pin parallel remote signals.
 This pin complies with the parallel remote connector of the SONY PCM-7000 series.

Connector: D-SUB 37 pin
Input: PNP transistor input, LOW active (pulse width 30msec. or larger).
Output: Open collector (+5V, 10kΩ, pull up)
+5V output: Max. 100mA
 Signals from No. 15, 16 and 17 pins are not pulse signals but are HIGH or LOW state signals.

* Refer to page 3 - 30 for details.

37P-REMOTE connector (D-SUB 37 PIN)

Connector pin assignment

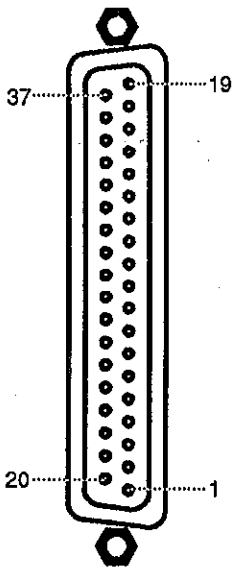

Pin	Signal	Pin	Signal		
1	GND	20	GND		
2	L-STOP STATUS	OUT	21	L-STOP COMMAND	IN
3	L-FF STATUS	OUT	22	L-FF COMMAND	IN
4	L-PLAY STATUS	OUT	23	L-PLAY COMMAND	IN
5	L-REW STATUS	OUT	24	L-REW COMMAND	IN
6	L-STANDBY STATUS	OUT	25	L-STANDBY COMMAND	IN
7	L-INPUT MONITOR STATUS	OUT	26	L-INPUT MONITOR COMMAND	IN
8	L-REC STATUS	OUT	27	L-REC COMMAND	IN
9	L-ID SEARCH STATUS	OUT	28	L-ID SEARCH COMMAND	IN
10	L-RAM SCRUB STATUS	OUT	29	L-ID PREVIOUS COMMAND	IN
11	L-START ID STATUS	OUT	30	L-START ID WRITE COMMAND	IN
12	L-SKIP ID STATUS	OUT	31	L-SKIP ID WRITE COMMAND	IN
13	L-END ID STATUS	OUT	32	L-END ID WRITE COMMAND	IN
14	L-CHASE STATUS	OUT	33	L-CHASE COMMAND	IN
*15	L-REVERSE COMMAND	IN	34	L-RAM SCRUB COMMAND	IN
*16	TAPE SPEED A COMMAND	IN	35	NC	
*17	TAPE SPEED B COMMAND	IN	36	RESERVE	
18	L-SERVO LOCK ON STATUS	OUT	37	RESERVE	
19	+5V	OUT			

Details of each signal

Signal	Functions	
	Command	Status
STOP	Stops tape transport.	The status of the D-30 is indicated by a combination of one or two status.
FF	Winds the tape forward at high speed.	
PLAY	Plays back the tape.	
REW	Winds the tape in reverse at high speed.	
REC	Records on the tape by simultaneous output of REC and PLAY commands.	
STANDBY	Can be switched between STANDBY (Pause)/OFF (Stop).	
SERVO LOCK		Status for indicating condition of servo lock or chase lock.
INPUT MONITOR	Audio output source can be switched (toggle).	Tape playback signal if status is Hi and input audio signal if status is Lo.
ID SEARCH (NEXT)	Locates to next S-ID and stops. Progressively locates to farther S-ID for number of times pressed and stops.	Status output indicating locate condition. This will indicate the status of both ID-Locate and Time Code-Locate. In this case, the the fast forward status is output for the ID-NEXT signal and the rewind status for ID-PREVIOUS signal.
ID SEARCH (PREVIOUS)	Locates to previous S-ID and stops. Progressively locates to previous S-ID for number pressed and stops.	
START-ID	Command for recording S-ID.	
SKIP-ID	Command for recording SKIP-ID.	ID detecting status.
END-ID	Command for recording END-ID.	ID detecting status.
CHASE	Switches ON the chase function contained in D-30.	Status of chase ON.
REVERSE TAPE SPEED A TAPE SPEED B	Enters tape or RAM shuttle operation. For playback speed, refer to "Control of tape/RAM playback speed."	Outputs STOP + FF or STOP + REW.
RAM SCRUB	Sound on tape is loaded in the RAM. For RAM playback speed, refer to "Control of tape/RAM playback speed."	When the RAM scrub status is ON, sound will be played back from the RAM by the REVERSE and TAPE SPEED A/B commands.

Control of tape/RAM playback speed

The tape speed and RAM playback speed can be changed as shown in the chart below by various combinations of TAPE SPEED A/B command signals from pins numbered 15, 16 and 17 of the 37 PIN REMOTE connector.

Normal operation (Pin No. 10 RAM SCRUB STATUS: Hi)

No.15	No.16	No.17	TAPE SPEED
-	H	H	STILL
H	H	L	x1
H	L	H	x3
H	L	L	x16
L	H	L	x-1
L	L	H	x-3
L	L	L	x-16

RAM SCRUB operation (Pin No. 10 RAM SCRUB STATUS: Lo)

No.15	No.16	No.17	RAM PLAYBACK SPEED
-	H	H	STILL (*)
H	H	L	x1/8
H	L	H	x1/2
H	L	L	x1
L	H	L	x-1/8
L	L	H	x-1/2
L	L	L	x-1

(*): If in STILL mode, RAM SCRUB is possible from the VIDEO editor (9 PIN REMOTE).

GPI OUT connector

Connector pin assignment

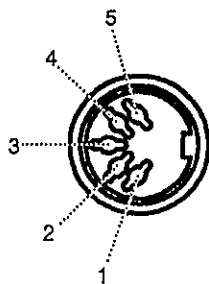

Pin	Signal
1	GND
2	EVENT OUT 1
3	EVENT OUT 0
4	EVENT OUT 2
5	EVENT OUT 3

TIME CODE INPUT connector
TIME CODE THRU connector
TIME CODE OUTPUT connector

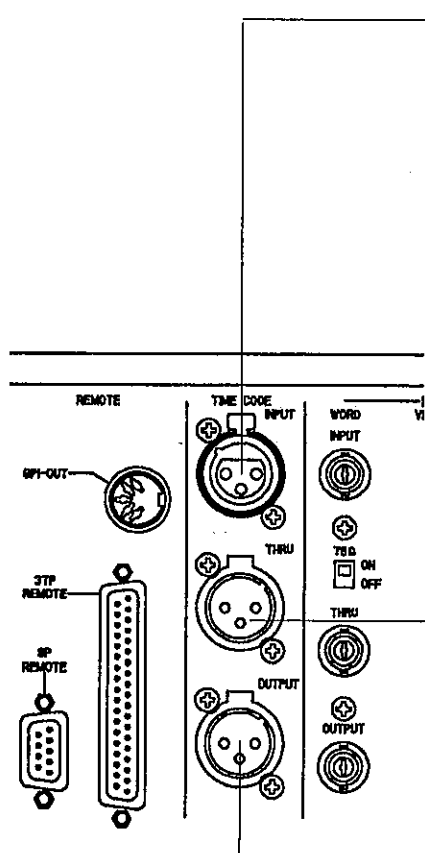
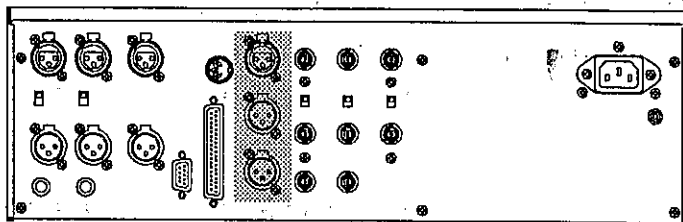

■ **TIME CODE INPUT connector**
External time codes are input here (BALANCE).

Connector: XLR-3-31 type
(Pin 1: GND, Pin 2: HOT, Pin 3: COLD)

■ **TIME CODE THRU connector**
Time code input to the TIME CODE IN connector is output here (BALANCE).

Connector: XLR-3-32 type
(Pin 1: GND, Pin 2: HOT, Pin 3: COLD)

■ **TIME CODE OUTPUT**
(Playback time code output) connector
Played back time codes are output here (BALANCE).

Connector: XLR-3-32
(Pin 1: GND, Pin 2: HOT, Pin 3: COLD)

Time code signals output here will be different depending on the operating mode.

Various modes of TC output can be set by the SETUP mode.

* Refer to chapter 9 for details on the SETUP mode.

EXT SYNC connector
 WORD IN connector
 Terminating switch
 WORD THRU connector
 WORD OUT connector

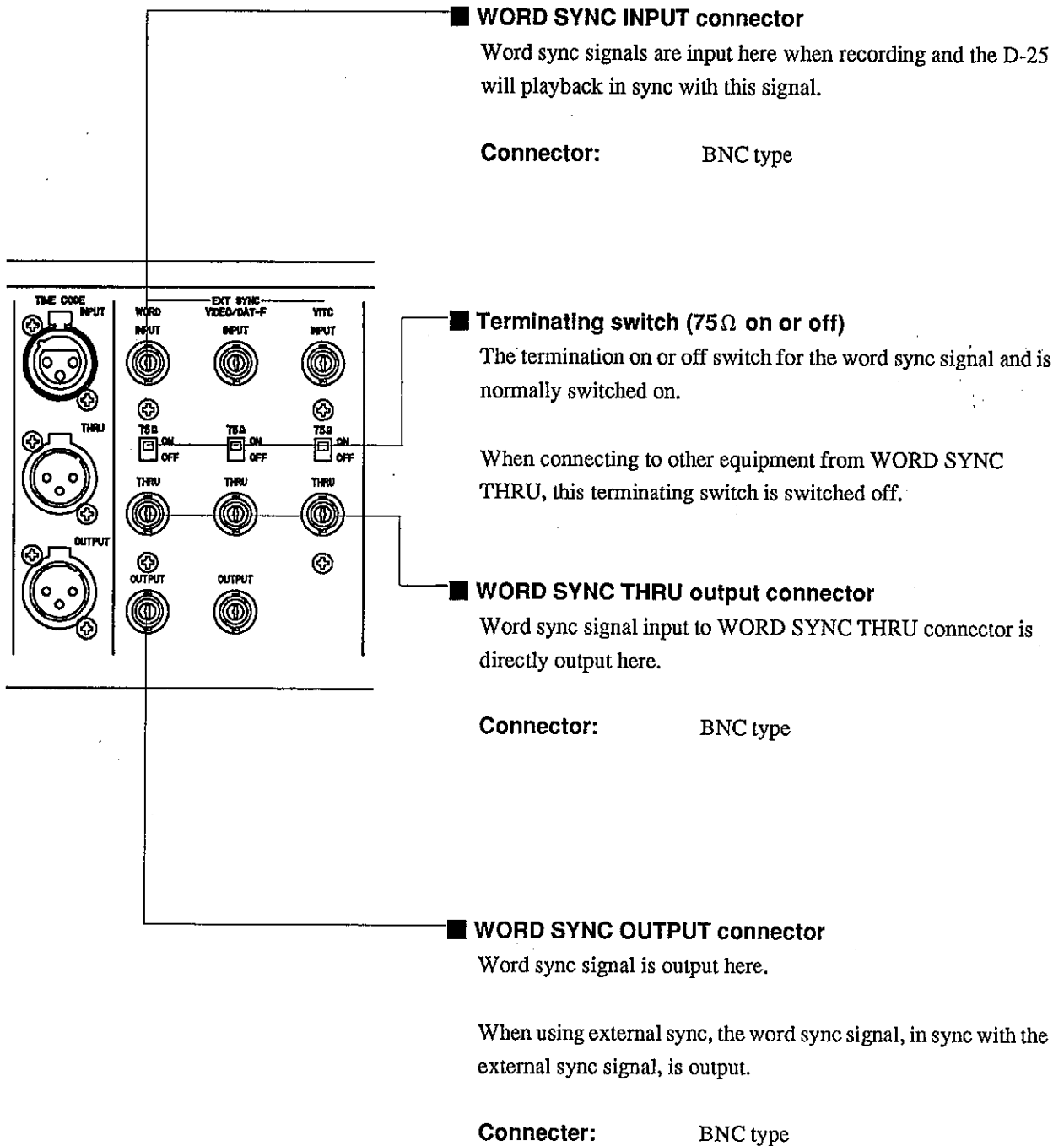
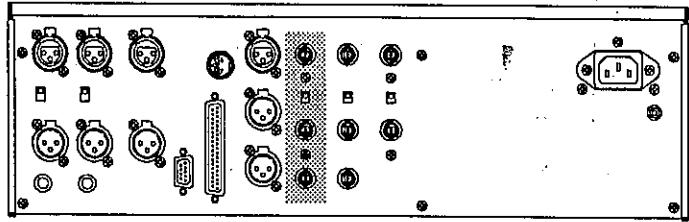

EXT SYNC connector

- VIDEO/DAT-F INPUT connector**
- Terminating switch**
- VIDEO/DAT-F THRU connector**
- VIDEO/DAT-F OUTPUT connector**

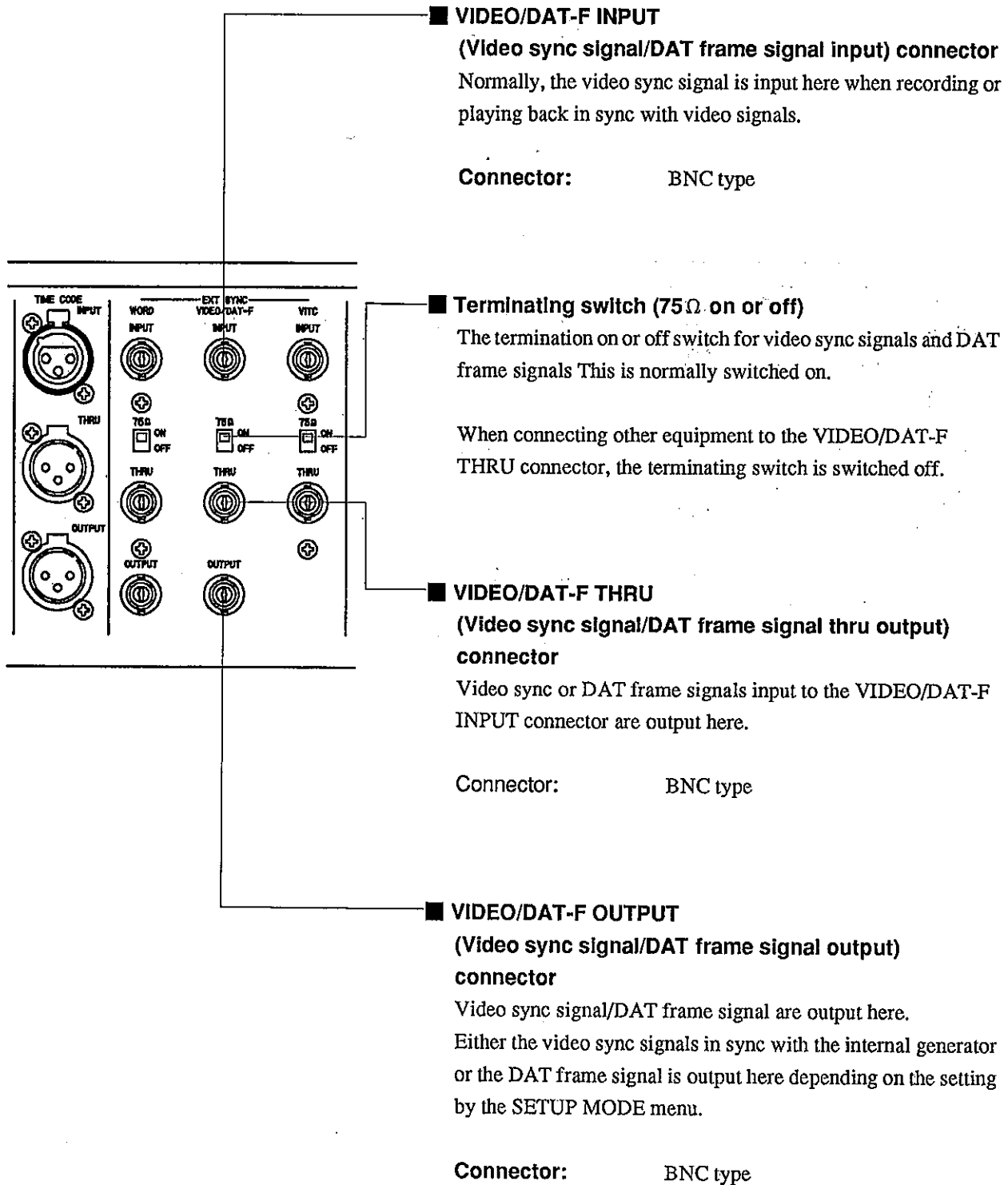
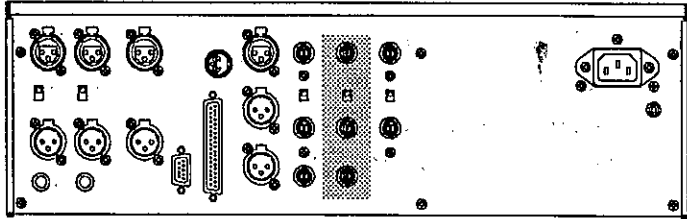

EXT SYNC connector
VITC INPUT connector
Terminating switch
VITC THRU connector

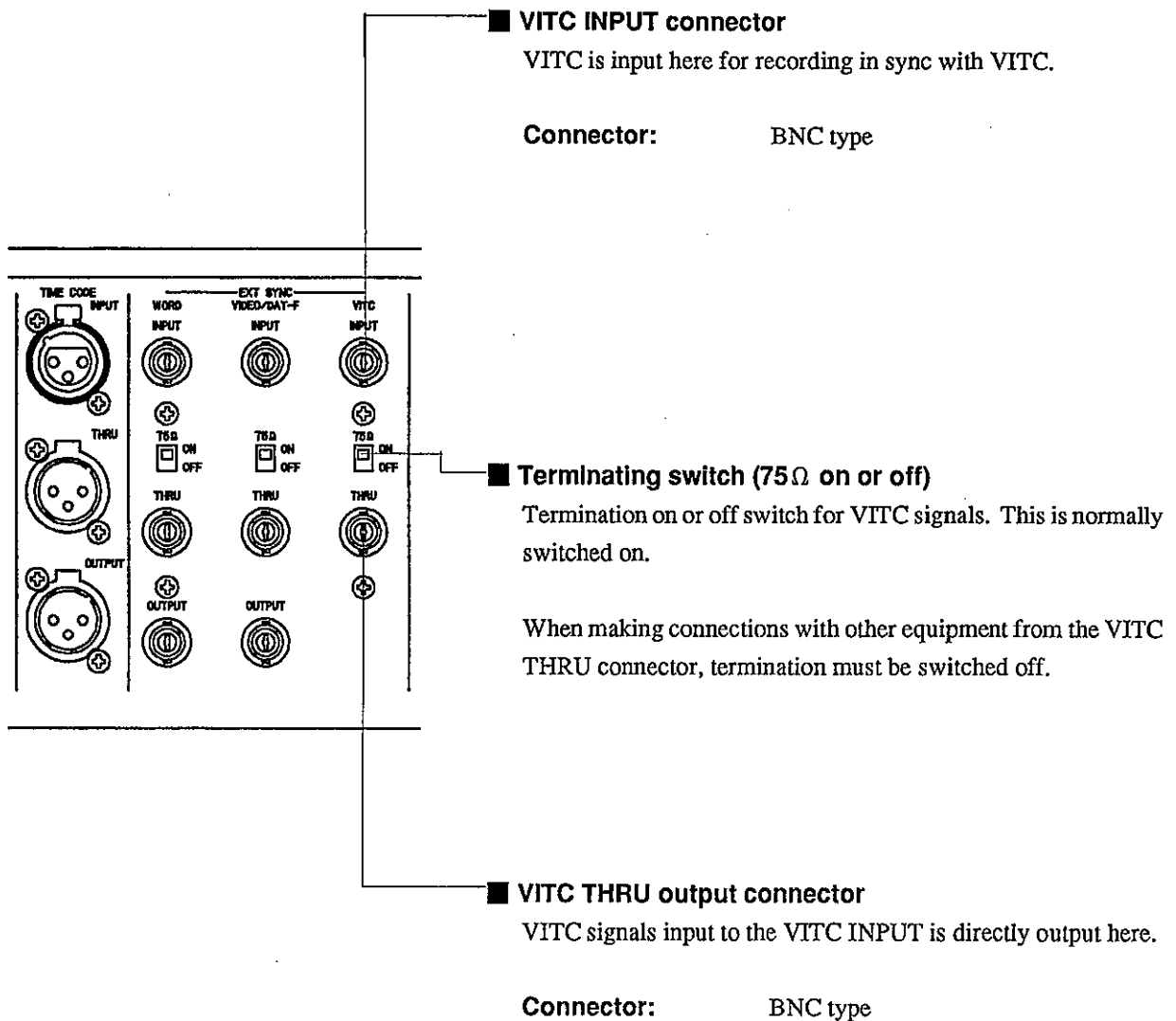
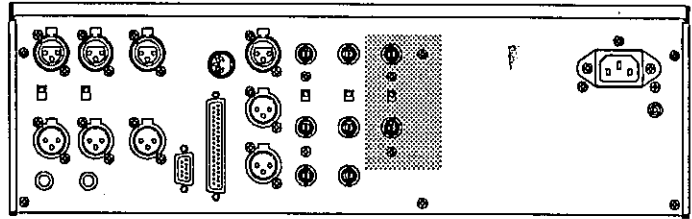

AC IN connector
GND terminal

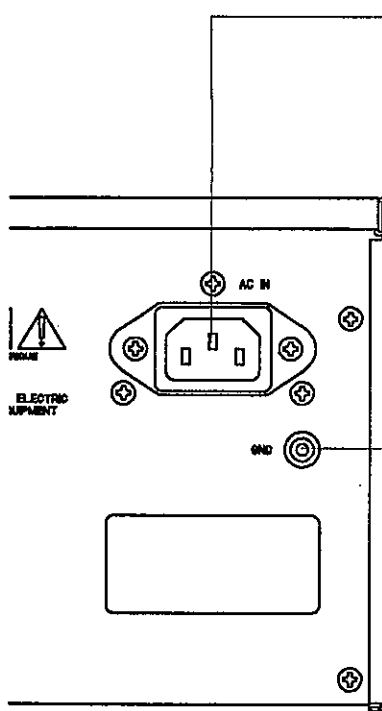
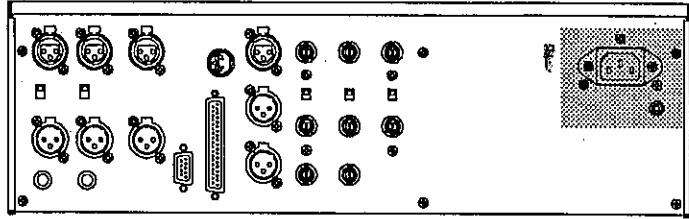

■ **AC IN (Power cable) connector**

The power cable packaged with this recorder is connected here.

<IMPORTANT>

Always plug the power cable to the recorder before plugging the cable into the wall outlet.

■ **GND terminal**

Chapter 4

Basic Operation

This chapter explains the basic operation of the D-25.

Included here are details of the recording and playback methods of analog and digital audio signals, S-ID search/memory locate methods, procedures involving the use of RAM for INSTANT START and AUTO CUE operation.

Chapter 4 Table of Contents

4-1. Basics of Audio Recording.....	4-1
4-2. Analog Audio Signal Recording.....	4-2
4-2-1. Insert Recording of Analog Audio Signals.....	4-4
4-2-2. Assemble Sound Recording of Analog Audio Signals.....	4-5
4-2-3. Assemble Sound Recording in the Confidence Mode.....	4-6
4-2-4. Analog Audio Signal Recording Level Adjustment.....	4-7
4-3. Digital Audio Signal Recording.....	4-8
4-3-1. Insert Recording of Digital Audio Signals.....	4-10
4-3-2. Assemble Sound Recording of Digital Audio Signals.....	4-11
4-3-3. Assemble Sound Recording in the Confidence Mode.....	4-12
4-4. Making No Recorded Section (REC MUTE).....	4-13
4-5. Sound Recording without Non-recorded Section (BLANK SEARCH).....	4-14
4-6. Basic Playback.....	4-15
4-7. Various Playbacks.....	4-18
4-7-1. Cuing in the JOG/SHTL Mode.....	4-18
4-7-2. Cuing in the RAM SCRUB Mode.....	4-19
4-7-3. S-ID Search.....	4-20
4-7-4. Time Locate.....	4-22
4-8. INSTANT START Mode.....	4-25
4-8-1. INSTANT START Operation.....	4-25
4-8-2. Execution of INSTANT START after Shift of Start Point.....	4-26
4-8-3. Rehearsal of INSTANT START with the PREVIEW/REPEAT Key.....	4-27
4-8-4. Locate/Search Using the INSTANT START Function.....	4-28
4-9. AUTO CUE Mode.....	4-30
4-9-1. S-ID Search Using the AUTO CUE Mode.....	4-31

4-1. Basics of Audio Signal Recording

Basic recording methods of analog and digital audio signals. Refer to Chapter 6, TIME CODE RECORDING, for time code recording.

There are two methods available for analog or digital audio recording.

1. Assemble Recording

The assemble recording method allows all kinds of data, including audio signals and time code, to be simultaneously recorded. Besides the normal assembly recording mode, a confidence mode is available. In the confidence mode, the audio signals which have just been recorded can be monitored (Read After Recording).

2. Insert Recording

The insert recording method allows audio signals and time code to be separately recorded.

<NOTE>

When insert recording performed on this machine alone, it is not possible to independently record on either the left or right audio track. However, with external communication using RS-422 (SONY 9 PIN PROTOCOL), the left or right track can be sound-recorded independently.

4-2. Analog Audio Signal Recording

Connections for recording

Please observe the following diagram when making connections for analog audio signal recording.

<IMPORTANT>

- * Turn off any equipment involved before connecting any audio equipment to the D-25.
- * The users manuals of equipment being connected should be studied in addition to this manual.

Points on Connections

1. Connect the output connector of the input signal source to the D-25 ANALOG INPUT connector.
2. Set the input level selector switch to the incoming signal level.
The selector switch is designed to accept 3 input levels of +4dBu, +4dBm and -10dBV.
3. Insert the headphone plug, or monitor system (amp and speakers) in the PHONES or MONITOR jack, respectively, for monitoring.

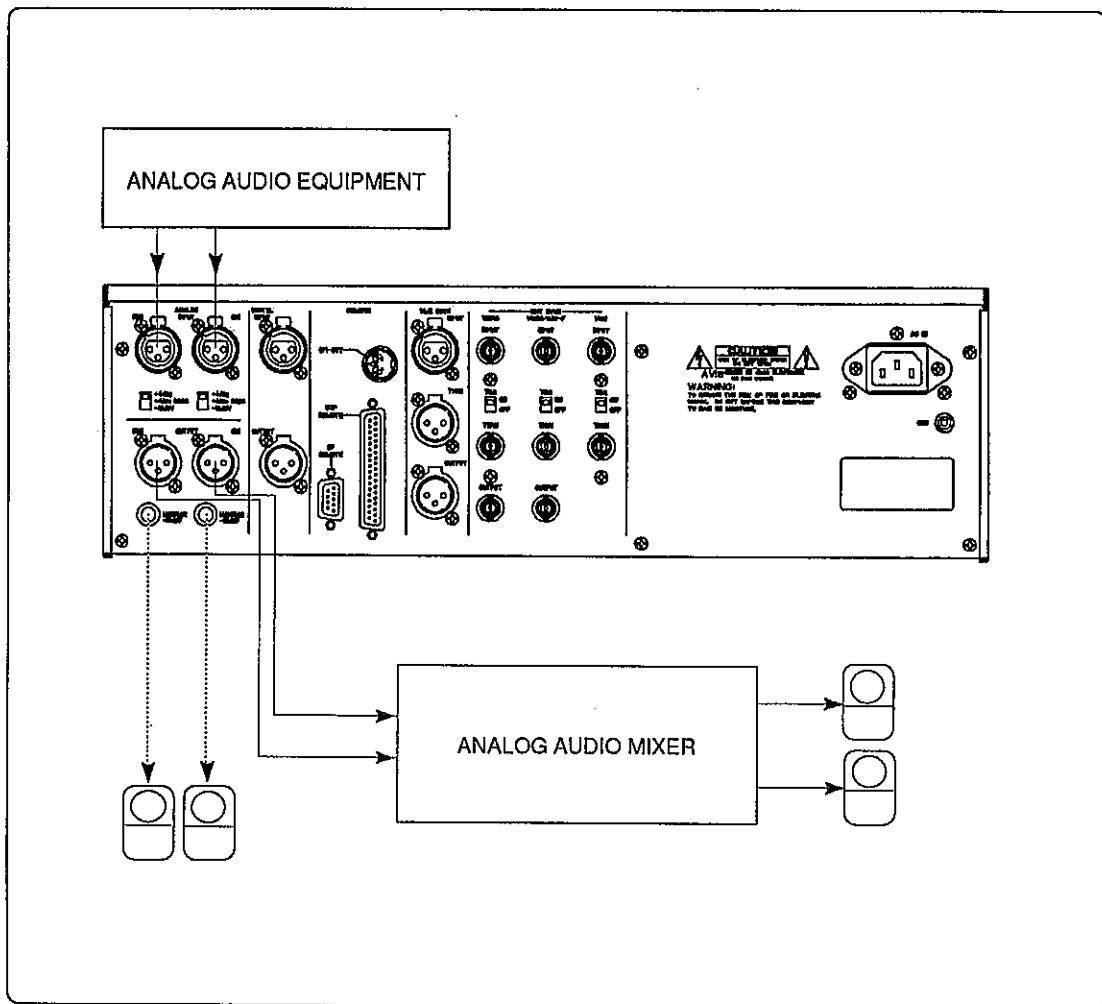

Items To Be Set Up Before Starting Sound Recording

1. Place a recording tape cassette in the tray.
2. Set the REMOTE switch to the "LOCAL" position.
3. Set the INPUT selection switch to the "ANALOG" position.
4. Set the CLOCK switch to the "INT" position.
5. Set the SAMPLING FREQ switch to match the FS to be recorded.
6. Determine whether to record sound with emphasis ON or OFF.
7. Set the INPUT LEVEL knob to the reference position ("CAL" position at the center).
8. Turn ON the AUTO-ID mode in SETUP mode "106- ****" if automatic S-ID recording is desired when sound recording.

* Refer to chapter 9, SETUP MODE, for details.

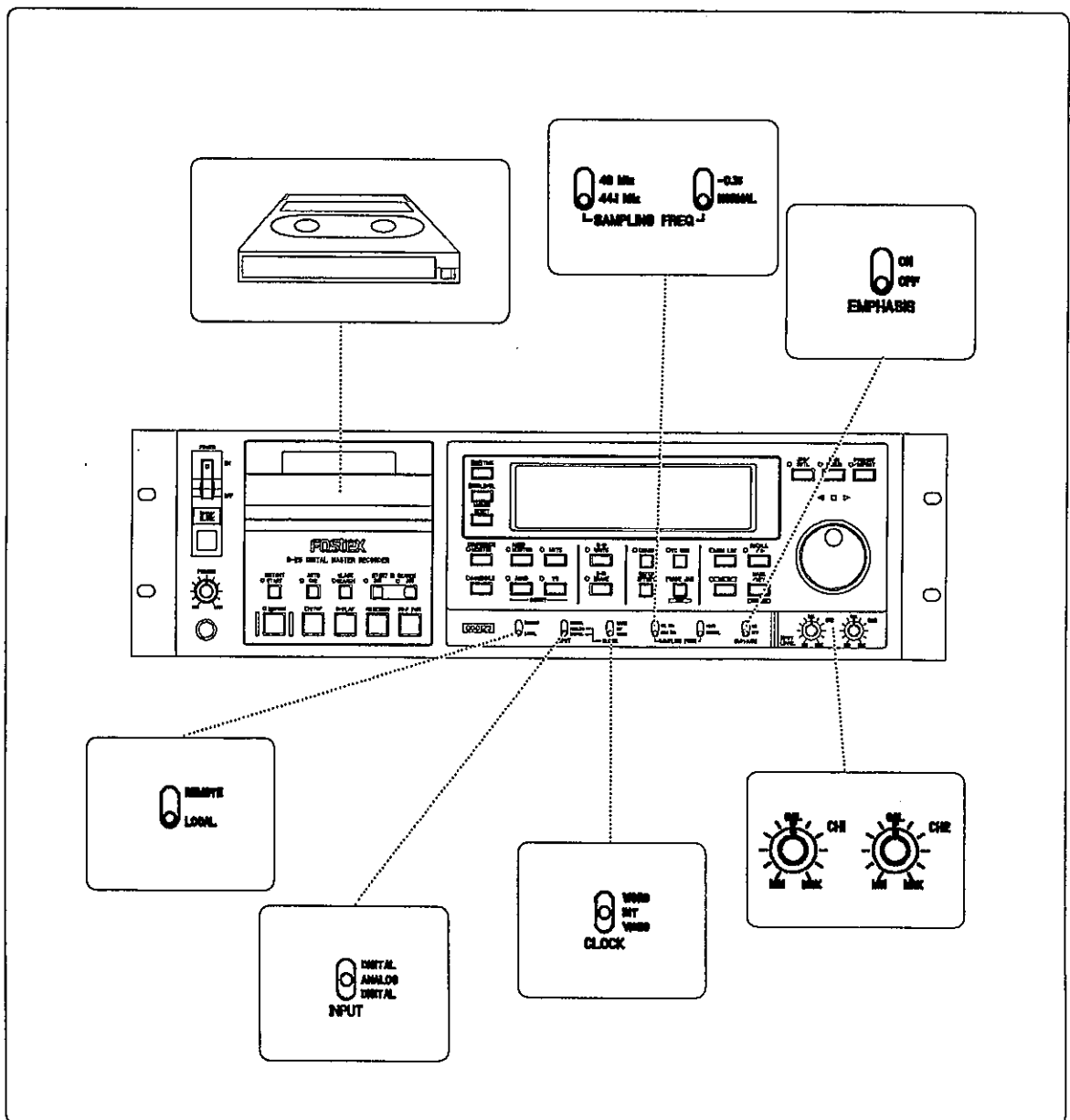

4-2-1. Insert Recording of Analog Audio Signals

Insert sound recording allows either audio signals or time code to be recorded.

<NOTE>

This function should only be used when performing insert-editing on a recorded tape.

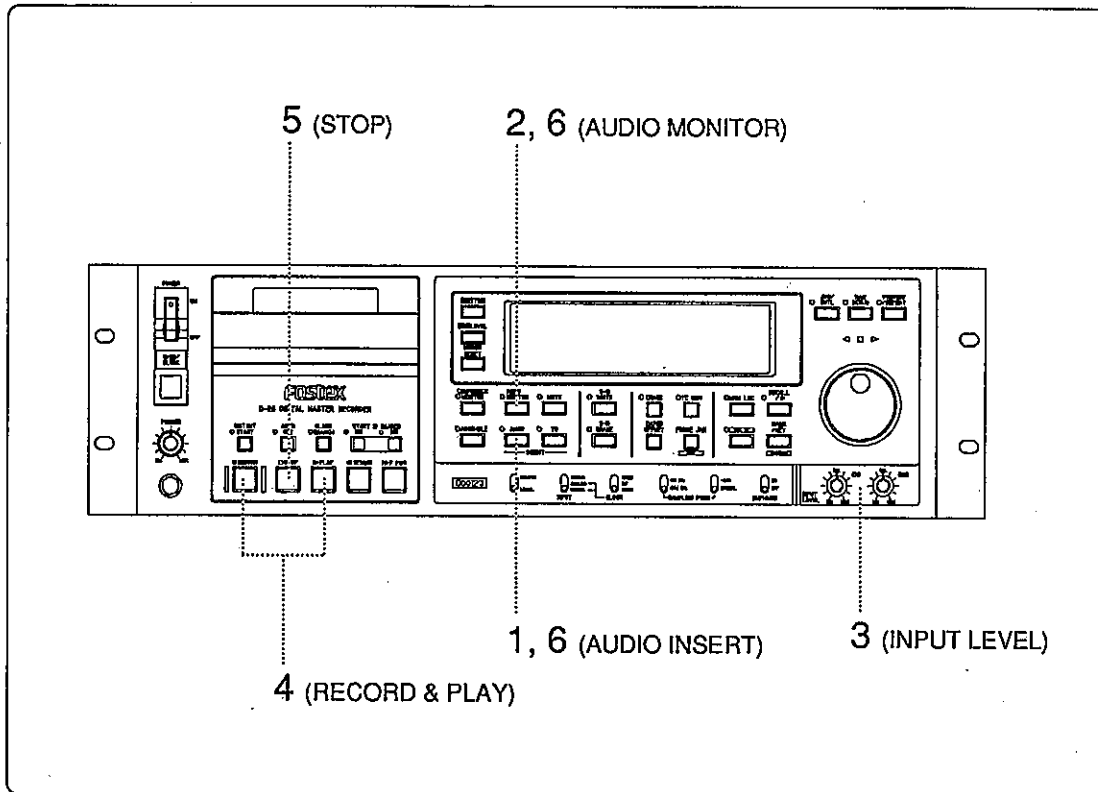

Operating Procedure

1. Turn on the AUDIO INSERT key only.
The AUDIO INSERT key LED will light.
To record time code alone, only the TC INSERT key should be turned on. (For time code recording, refer to chapter 6, TIME CODE RECORDING.)
2. Turn the AUDIO MONITOR key ON for monitoring audio input signals.
3. Adjust the recording level using the audio signal before starting recording.
Refer to paragraph 4-2-4 for the adjustment method.
4. Hold the RECORD button, and press the PLAY button.
The RECORD/PLAY button lamp will light, and sound recording will start.
While recording, the audio input signal can be monitored.
5. After completion of recording sound, press the STOP button to release therecording mode.
6. Press the AUDIO INSERT and AUDIO MONITOR keys to turn off the insertmode and input monitor.

4-2-2. Assemble Sound Recording of Analog Audio Signals

Unlike insert recording, the assemble recording mode can record both audio signals and time code simultaneously.

In the assemble sound recording mode, there are two sound recording methods available. The normal sound recording mode permits monitoring the input while recording, or confidence mode which allows for monitoring the sound just after recording (Read After Recording).

* Refer to paragraph 4-2-3 for the confidence mode sound recording.

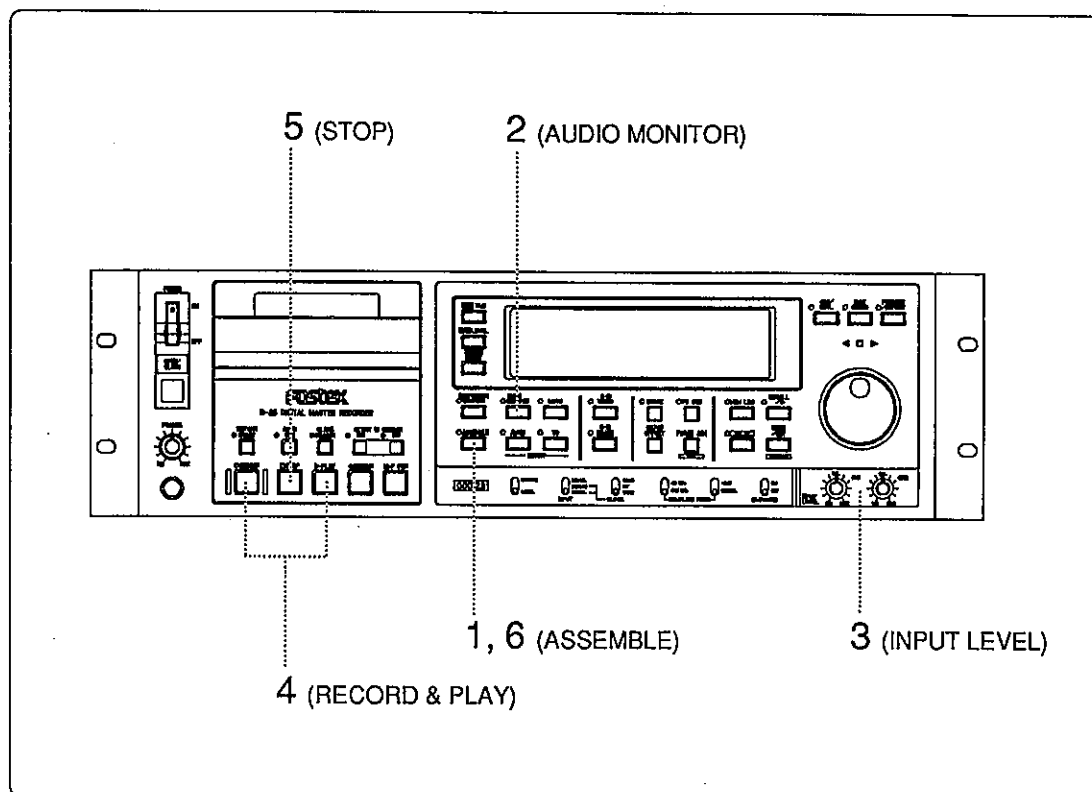

Operating Procedure

1. Press the ASSEMBLE key to turn on the assemble mode.
The AUDIO INSERT and TC INSERT modes will also be turned on causing all LEDs involved to light.
2. Turn the AUDIO MONITOR key on.
The audio tracks will be put in the input monitor mode.
3. Adjust the sound recording level using the same procedure followed with the insert sound recording.
Refer to paragraph 4-2-4 for the adjustment method.
4. Hold the RECORD button and press the PLAY button to start sound recording.
5. When sound recording is finished, press the STOP button to end recording.
6. Press the ASSEMBLE key to turn the assemble mode off.

4-2-3. Assemble Sound Recording In The Confidence Mode

The confidence mode is a simultaneous monitoring mode which permits read after recording allowing the monitoring of sound materials as soon as they are recorded.

In this mode, no other sound recording methods including insert sound recording are possible.

<IMPORTANT>

If locate and search is executed in the confidence mode, occasionally A-TIME and time code stored in the sub area will not be read accurately because of this confidence mode. Therefore, when executing locate and search, we recommend using to use the normal mode.

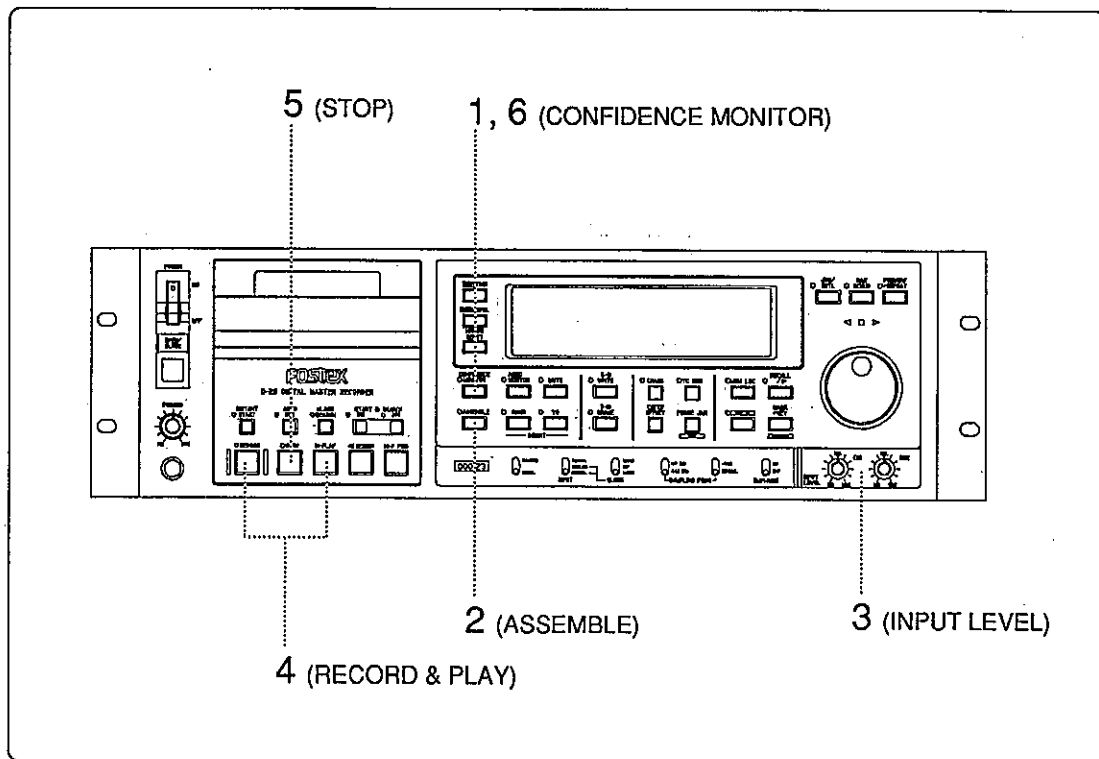

Operating Procedure

1. Press the CONFIDENCE MONITOR key to turn on the confidence mode.
2. Press the ASSEMBLE key to turn on the assemble mode.
3. Adjust the recording level using the audio signal before starting sound recording.
Refer to paragraph 4-2-4 for the adjustment method.
4. Hold the RECORD button and press the PLAY button to start sound recording.
5. After sound recording is finished, press the STOP button to end recording.
6. Press the CONFIDENCE MONITOR key to turn the confidence mode off.

The assemble mode will also turn off at the same time.

4-2-4. Analog Audio Signal Recording Level Adjustment

When recording analog audio signals, adjust the input recording signals to an appropriate level for distortion free sound.

The level meter provided on the D-25 is capable of holding the input signal peak values for about 2 seconds, indicating the safety margin to the maximum recording level of 0dB.

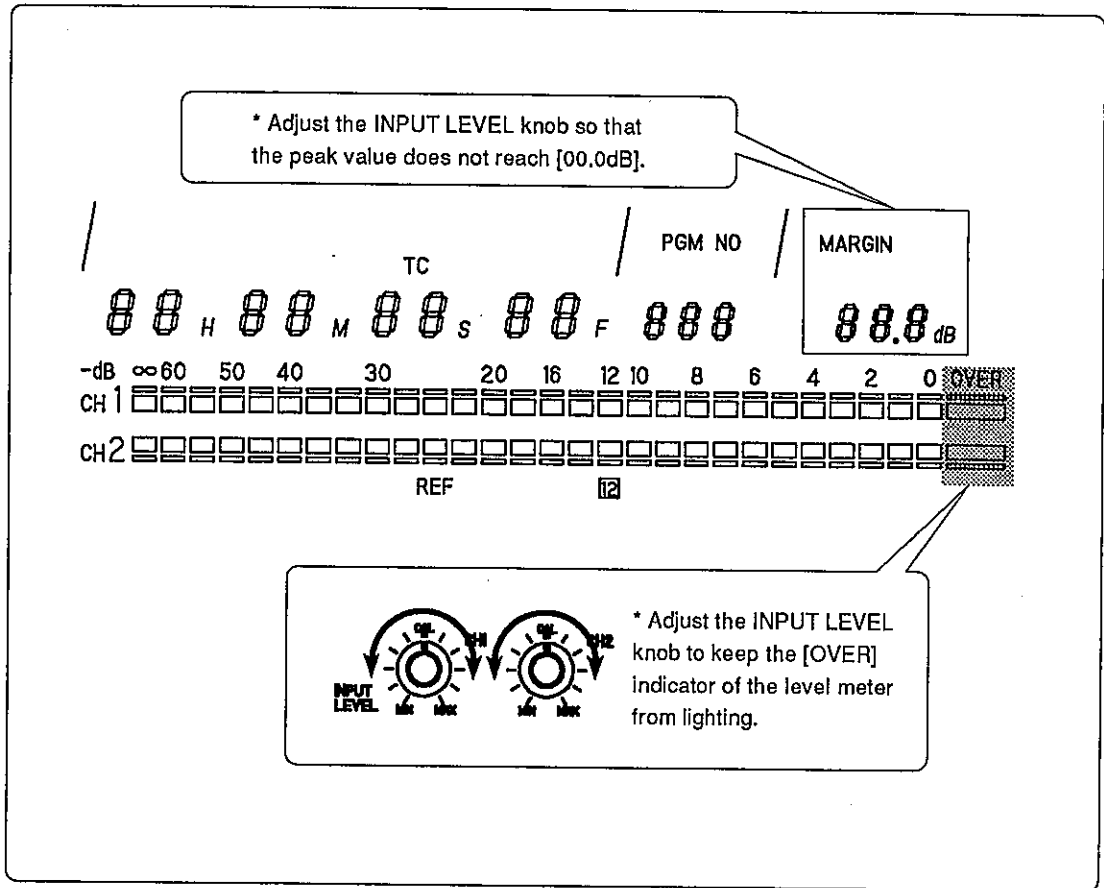

The value shown by the MARGIN display will change to a larger number as the signal input levels increase. This function can be used as a substitute for permanent peak hold. The margin level, and CH1 and CH2 input levels can be viewed by switching the DISP LEVEL key.

Points on Level Adjustment

- * When adjusting the sound recording level, use the INPUT MONITOR (turn on the AUDIO MONITOR key).
- * Adjust the INPUT LEVEL knob so the level meter does not exceed 0dB at maximum peak sound level input and so the margin level will remains at 00.0dB or under.

<IMPORTANT>

Sound distortion will result if recording levels are higher than [0dB].

4-3. Digital Audio Signal Recording

Digital audio signals are recorded in a manner similar to analog signal recording, but connections and switch settings must be made differently.

Connections

1. Connect the OUTPUT connector of other digital audio equipment (DAT, digital mixer, etc.) to the D-25 DIGITAL IN connector.

<NOTES>

- * Turn off any equipment in the signal path before connecting any audio equipment to the D-25.
- * The users manual of any equipment being connected should also be referred to in addition to this manual.

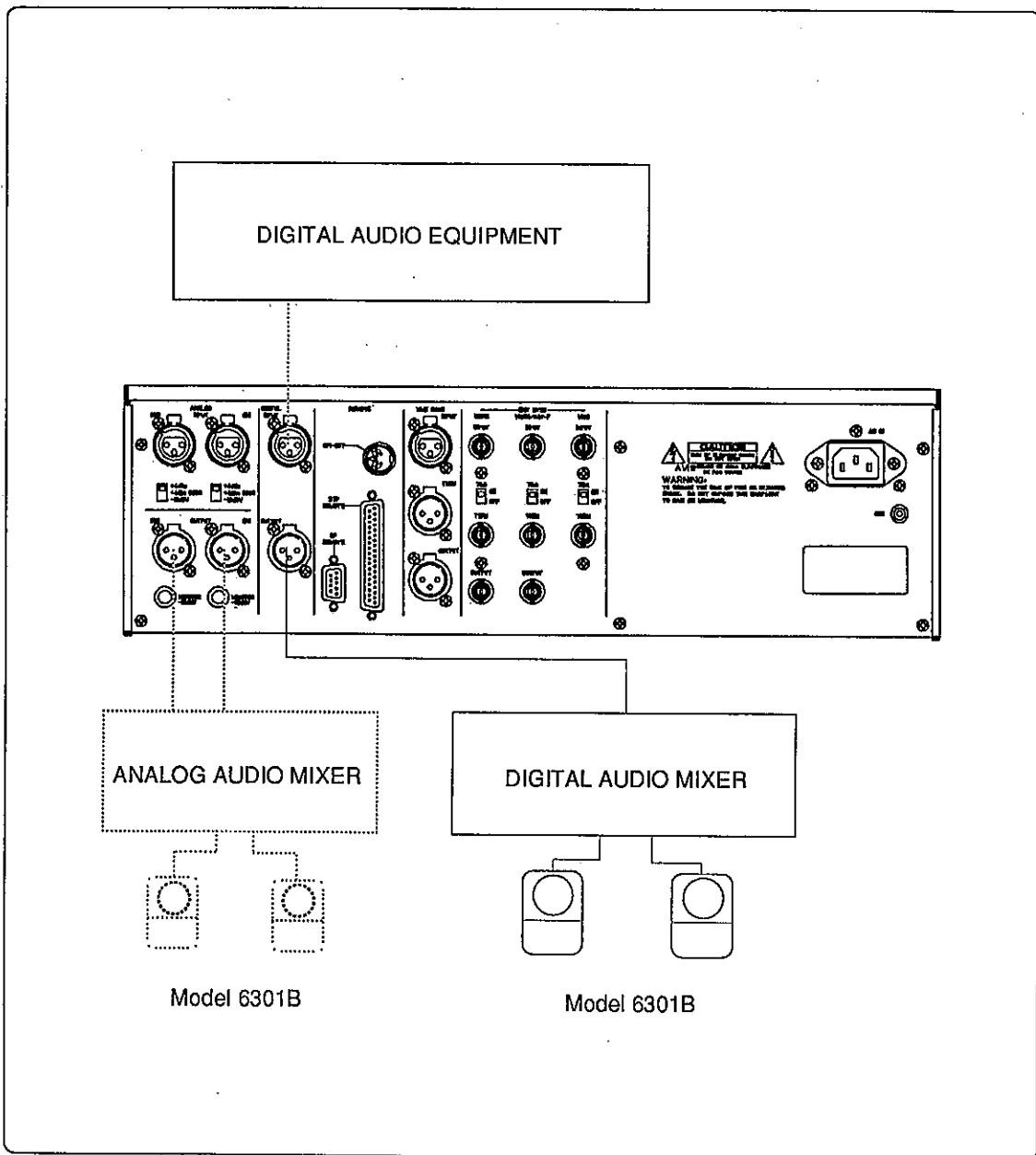

Set before recording as below:

1. Set the INPUT selection switch to the "DIGITAL" position;
2. Set the REMOTE switch to the "LOCAL" position.
3. Turn on the AUTO-ID mode in SETUP mode "106- ****" if an automatic S-IDrecording is desired while sound recording is being carried out.
For details, refer to Chapter 9 - SETUP MODE and Chapter 5 - SUB-ID RECORDING AND ERASURE.

<NOTE>

Frequency setting and emphasis settings will be made automatically depending on the digital input information, without regard to switch settings on the D-25. However, disagreement between the D-25 and what is being input may result in occasional drop-out of the signal. Should this happen, change the frequency setting of the D-25 to go with that of the input.

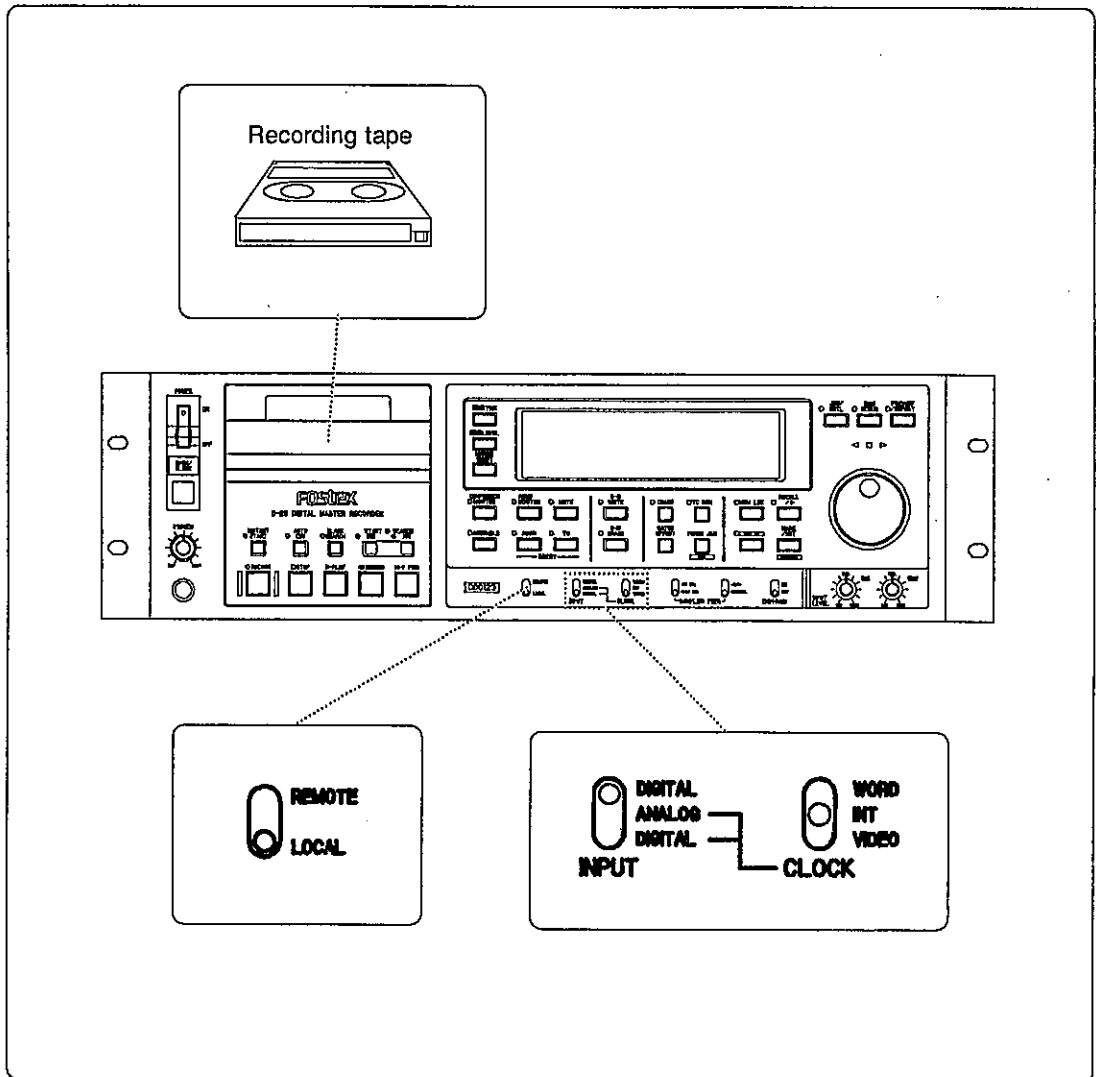

4-3-1. Insert Recording of Digital Audio Signals

Audio signals and time code, as with insert recording of analog audio signals, can be recorded independently.

<NOTE>

This operation should only be used when performing insert-editing on recorded tape.

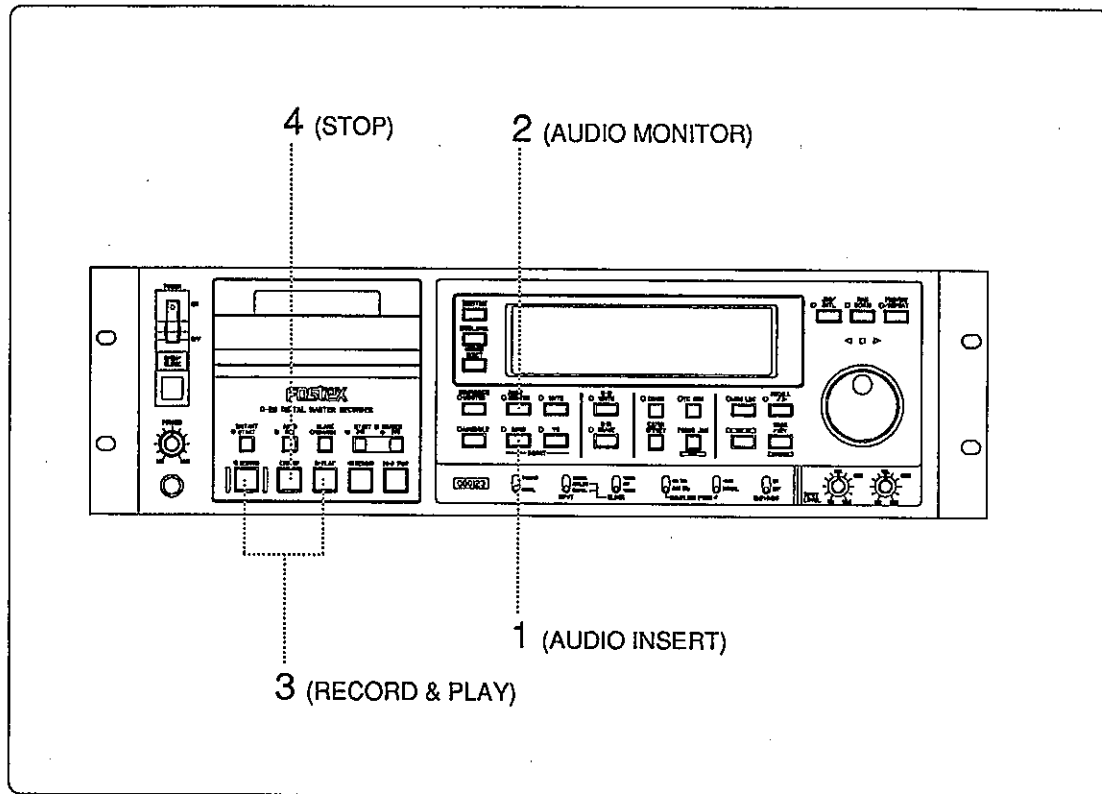

Operating Procedure

1. Turn on the AUDIO INSERT key.
The AUDIO INSERT key LED will light.
 2. Turn on the AUDIO MONITOR key.
The AUDIO MONITOR key LED will light.
 3. Hold the RECORD button and press the PLAY button.
The RECORD button and PLAY button lamps will light, and sound recording start.
The digital audio signals can be monitored while being recorded.
- * No sound recording level adjustment on the D-25 is required when recording digital audio signals, because recording will be made at the same level as that of the incoming digital audio signal.
4. After recording is completed, press the STOP button to end recording.

4-3-2. Assemble Sound Recording of Digital Audio Signals

Unlike insert sound recording, all audio signals and time code can be simultaneously recorded while assemble sound recording, the same as with analog audio signal recording.

There are two methods of assemble signal recording; recording under the normal input monitoring mode and recording in the confidence mode which permits monitoring the recorded materials just after the sound signal is recorded (Read After Recording).

* Refer to the paragraph 4-3-3 for information on confidence mode recording.

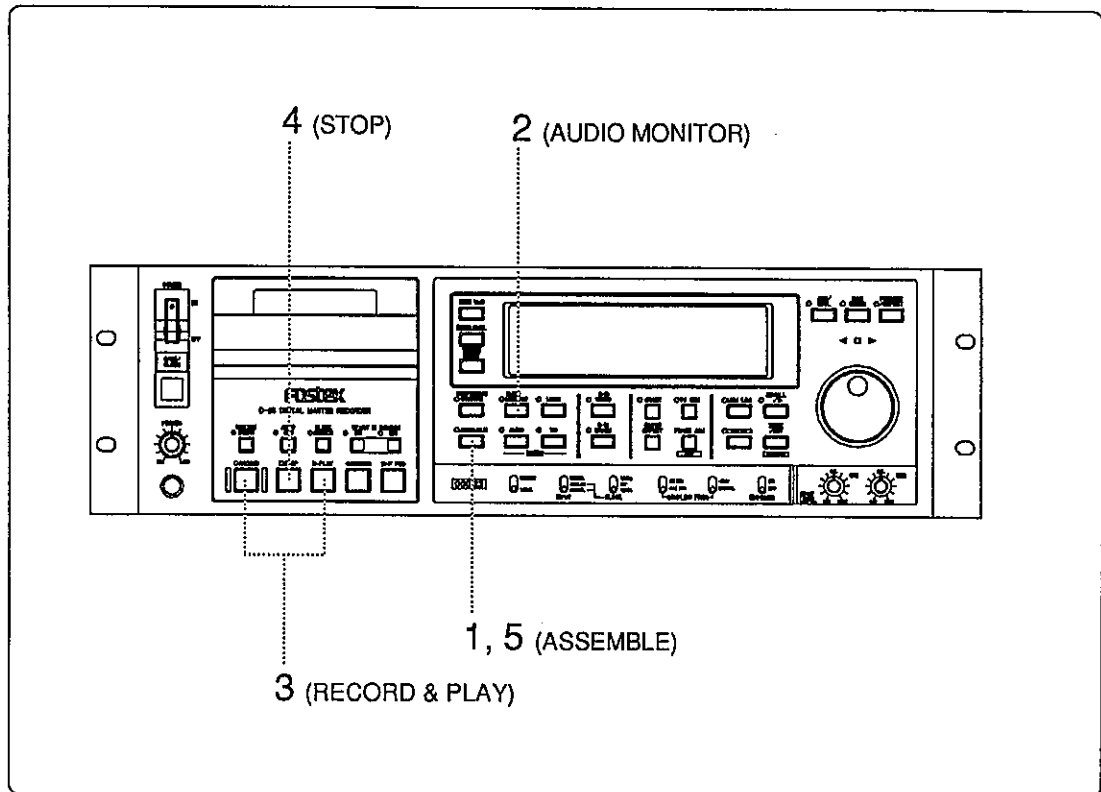

Operating Procedure

1. Turn the ASSEMBLE key on.
The AUDIO and TC insert modes will also turn on.
2. Turn the AUDIO MONITOR key on.
The AUDIO MONITOR key LED will light.
3. Hold the RECORD button and press the PLAY button.
The RECORD/PLAY button lamp will light, and sound recording will start.
4. After completion of recording, press the STOP button to end recording.
5. Turn the ASSEMBLE key off.
The ASSEMBLE and AUDIO/TC INSERT key LEDs will go off.

4-3-3 Assemble Sound Recording In The Confidence Mode

The same as with analog audio signal recording, the confidence mode is a monitoring function which permits playback right after recording.

In this mode, the only possible recording mode is assemble sound recording. No insert or other sound recording methods can be performed.

<IMPORTANT>

If locate and search is executed in the confidence mode, occasionally A-TIME and time code stored in the sub area will not be read accurately because of this confidence mode. Therefore, when executing locate and search, we recommend using to use the normal mode.

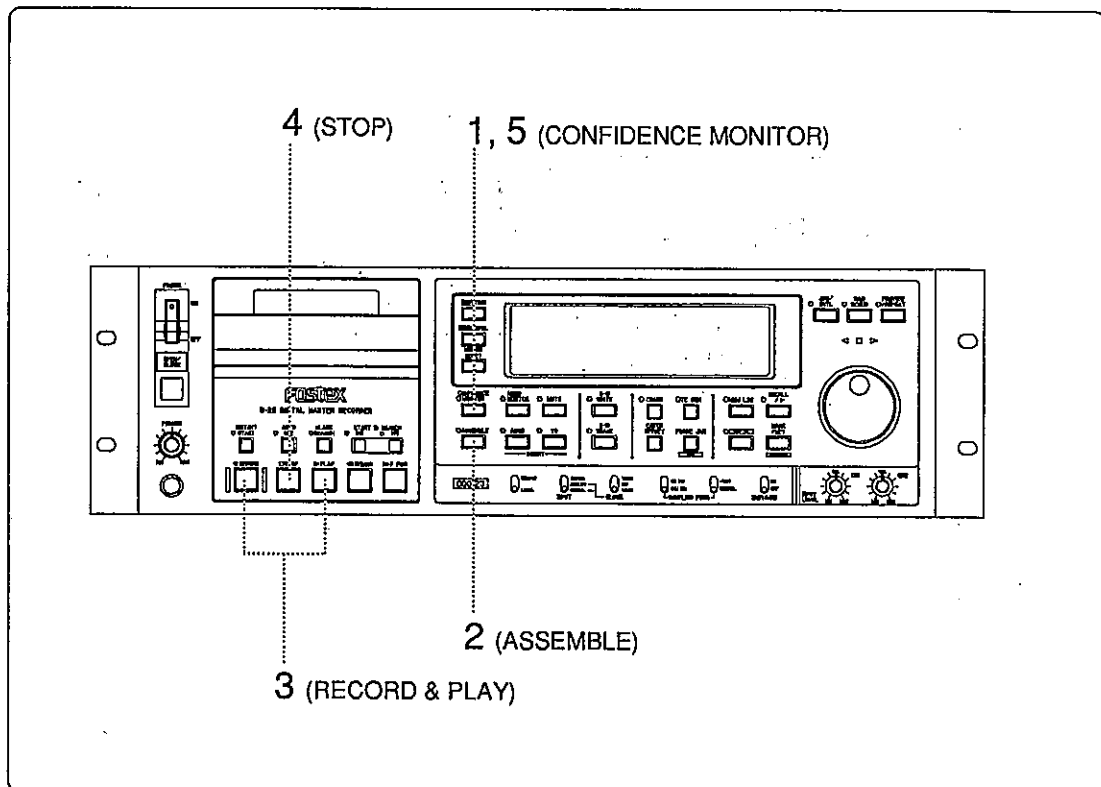

Operating Procedure

1. Press the CONFIDENCE MONITOR key to turn the confidence mode on.
The CONFIDENCE MONITOR key LED will light.
2. Press the ASSEMBLE key to turn the assemble mode on.
The ASSEMBLE and AUDIO/TC INSERT key LEDs will light.
3. Hold the RECORD button and press the PLAY button to start sound recording.
4. After completing sound recording, press the STOP button to end recording.
5. Press the CONFIDENCE MONITOR key to turn the confidence mode off.
The assemble mode will also be turned off.

4-4. Making No Recorded Section (REC MUTE)

Non-recorded sections should not be present on the tape when sound recording with DAT, as explained in paragraph 2-4 Chapter 2.

Introduced here is REC MUTE which involves the MUTE key. Using this, to record without making a non-recorded section.

Make a "non-recorded section" with the MUTE key while sound recording, so that continuity of A-TIME will be retained on the tape.

* This procedure can be applied to both ANALOG IN and DIGITAL IN.

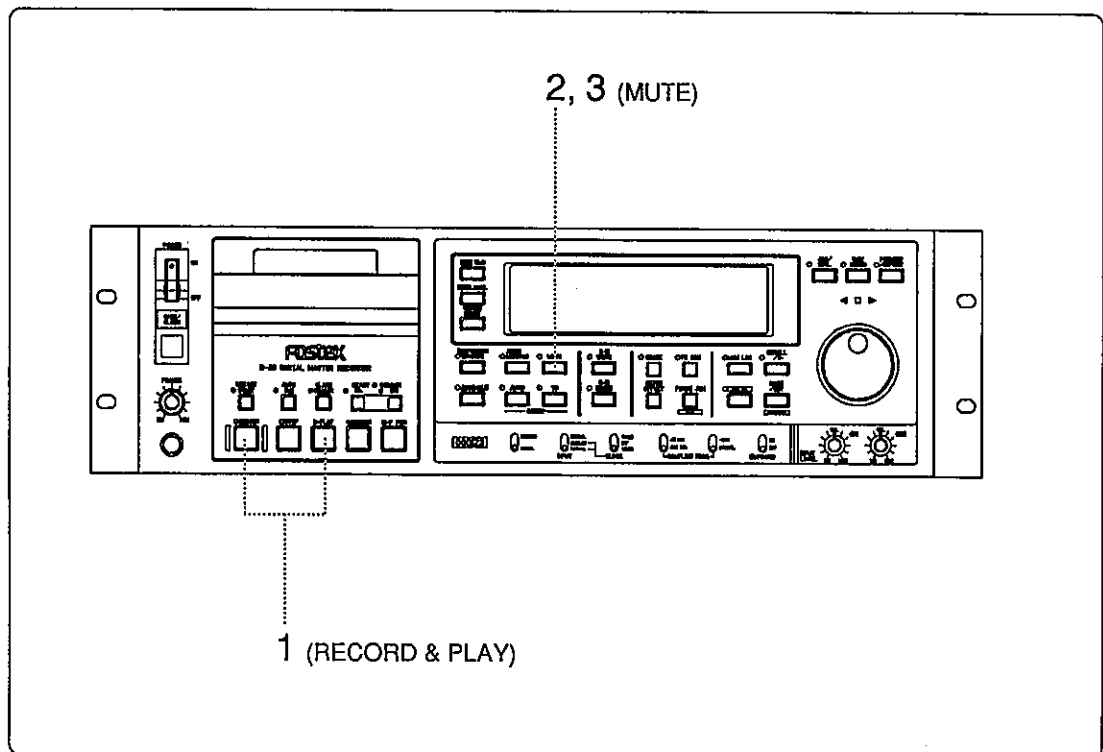

Operating Procedure

1. Hold the RECORD button and press the PLAY button to start sound recording.
2. Hold the MUTE key, while sound recording, in the area where a non-record section is desired.
As long as the button is held, REC MUTE is in effect (The MUTE key LED will light.), and a non-record section will result.
3. Release the MUTE key to stop REC MUTE.
The MUTE key LED will go off.
4. Repeat step 2 above for more no-recorded sections.

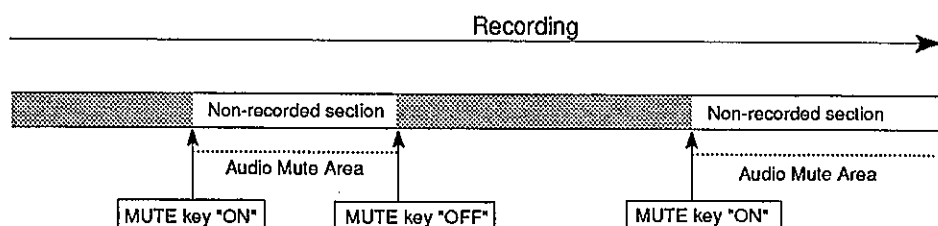

4-5. Sound Recording Without Non-recorded Section (BLANK SEARCH)

Blank search is the function by which the end point of recording (the END-ID) can be identified. Continuous sound recording without non-recorded sections on the tape is possible when this function is used. This function will precisely locate the end point of recording, which is necessary when re-starting sound recording halfway through an uninterrupted recording in assembly editing.

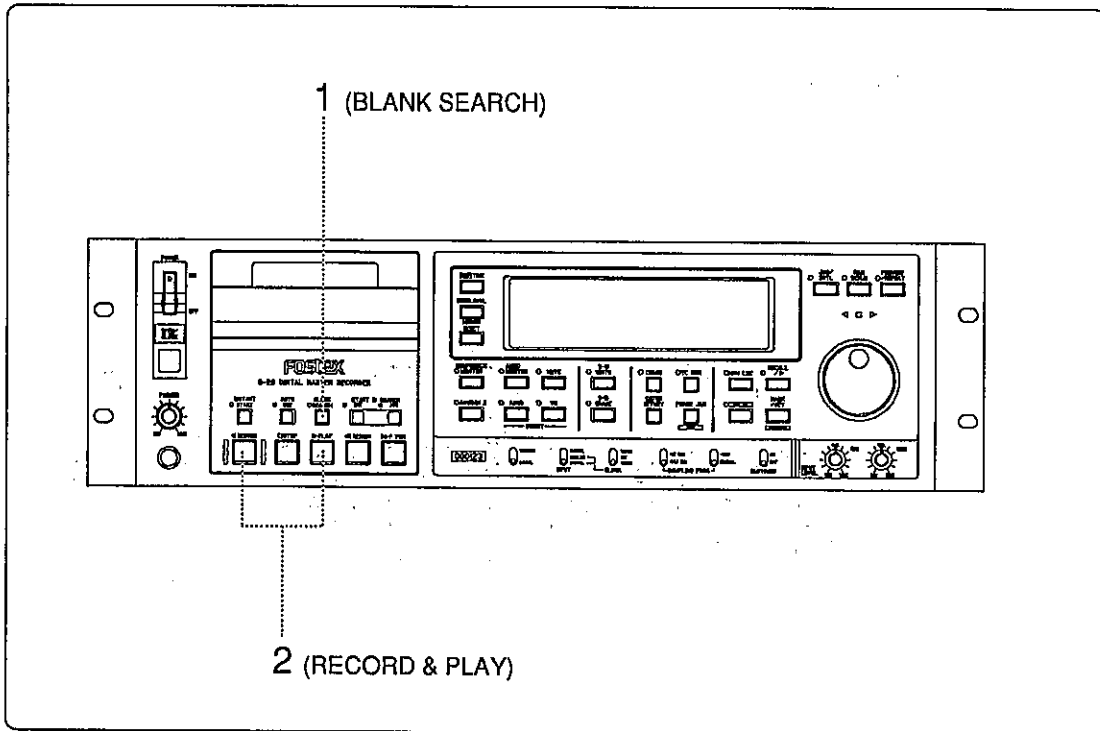

Operating Procedure

1. Before starting sound recording, press the BLANK SEARCH key.
The BLANK SEARCH key LED will light, and search for non-recorded sections will be initiated.
The LED will go off as soon as searching is finished, and the D-25 will pause for two seconds prior to the end point of a non-recorded section or END-ID.
2. Hold the RECORD button and press the PLAY button.
Sound recording will start from the end point of previously recorded material with no non-recorded section left.

<NOTES>

- * Automatic BLANK SEARCH will start when a cleaning tape is loaded. Press the STOP button to stop the tape.
- * The blank search function will not work when the INSTANT START mode is on.

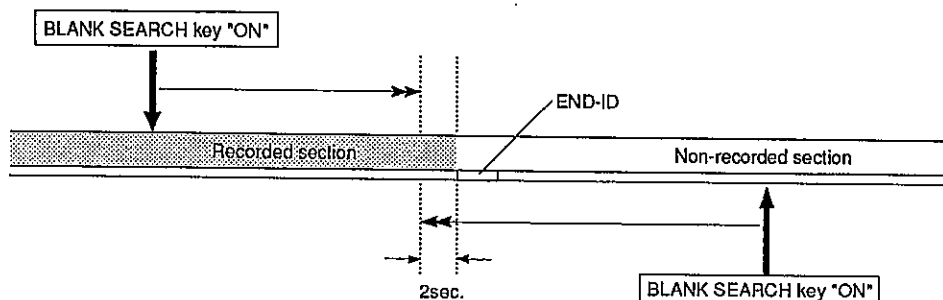

4-6. Basic Playback

Basic playback methods of the D-25 are described here.

Connections

Equipment should be connected as follows when playing back sound tape recorded with the D-25.

<NOTES>

- * Turn off all equipment connected to the D-25 before any other equipment is connected.
- * The owner's manuals of equipment being connected to the D-25 should also be read for details and cautions.

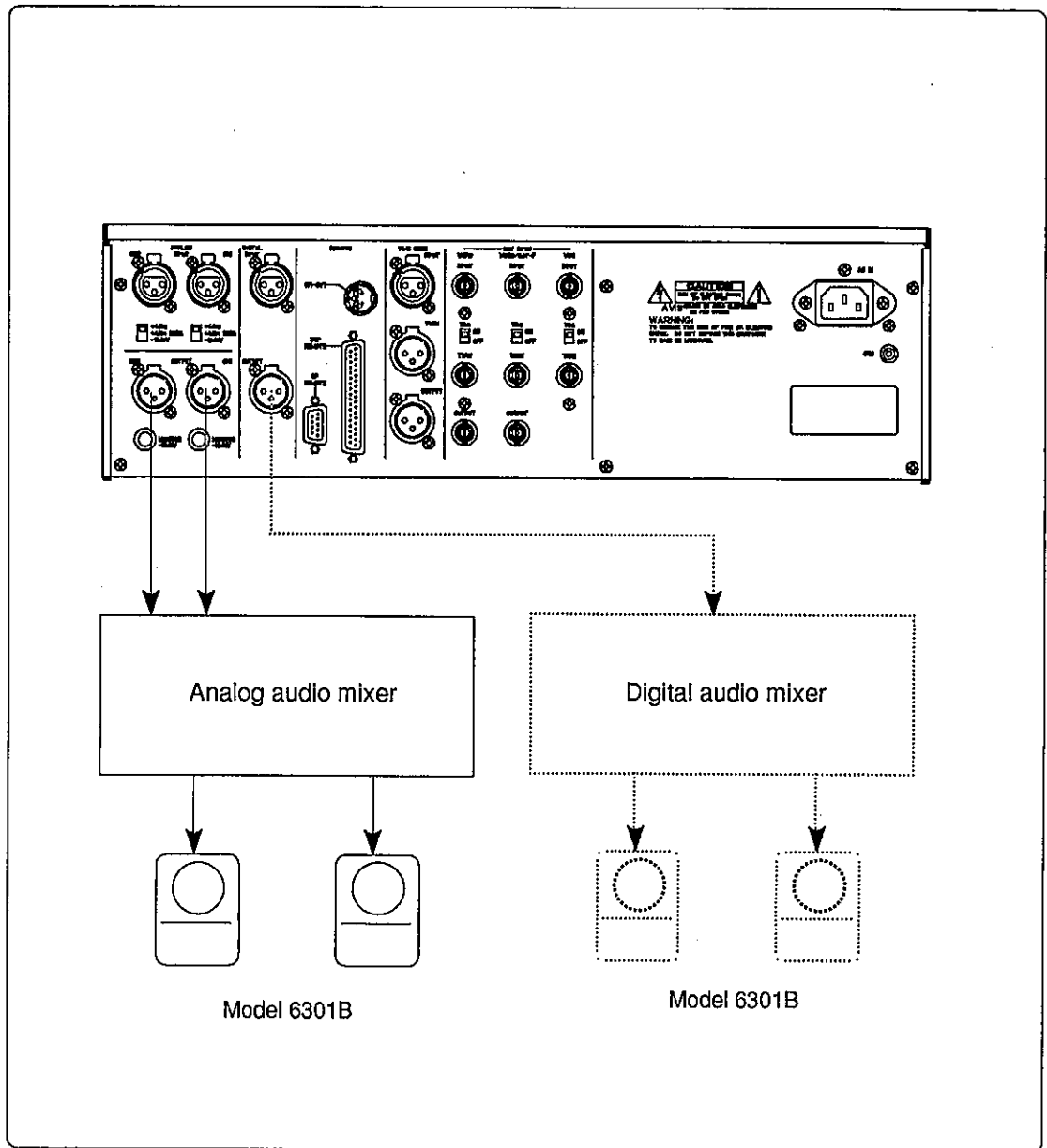

Setting prior to before playback

1. Turn the D-25 on.
2. Load sound recorded tape.
3. Set the REMOTE switch to the "LOCAL" position.
4. Turn the AUDIO MONITOR key off.
5. Turn both ASSEMBLE and INSERT keys off.

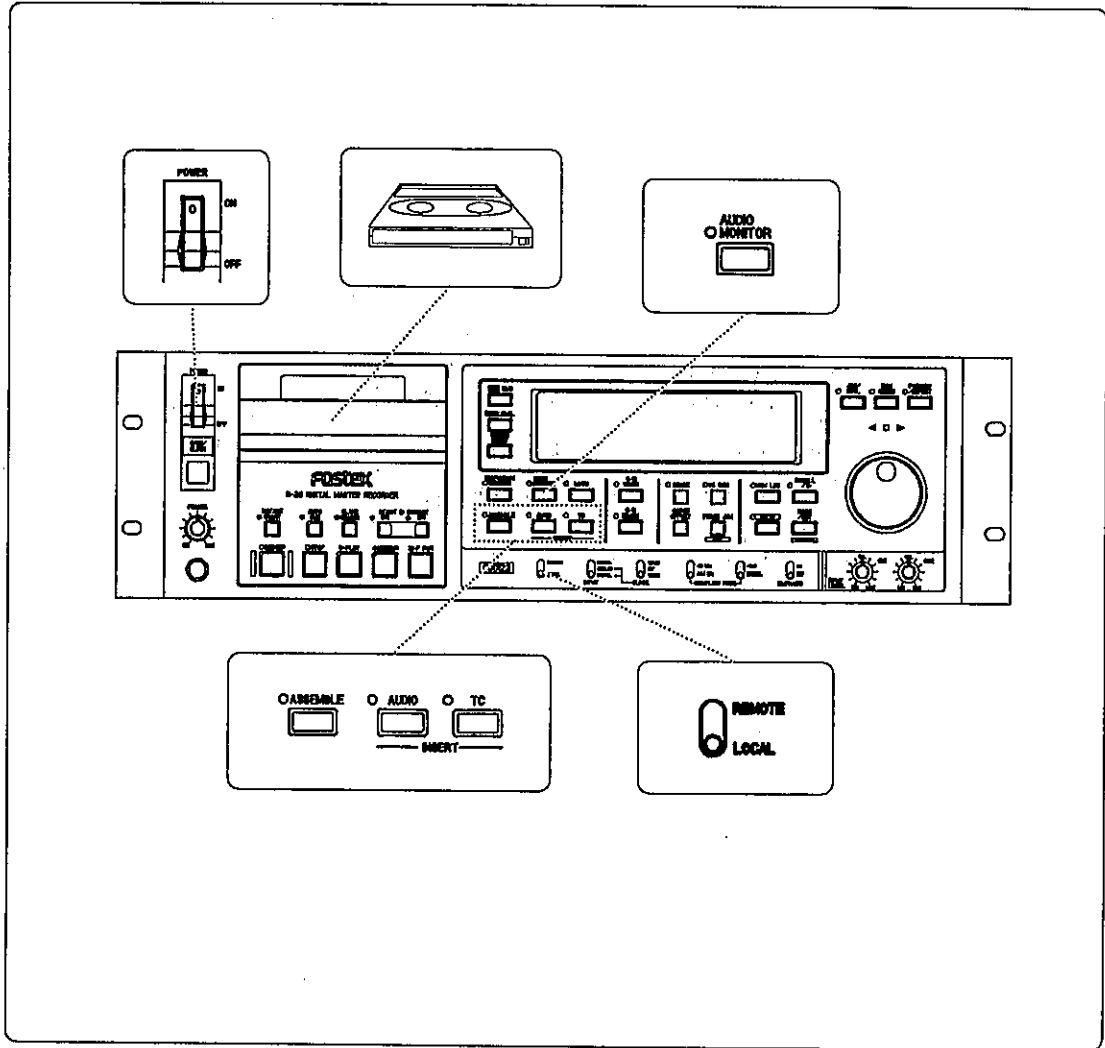

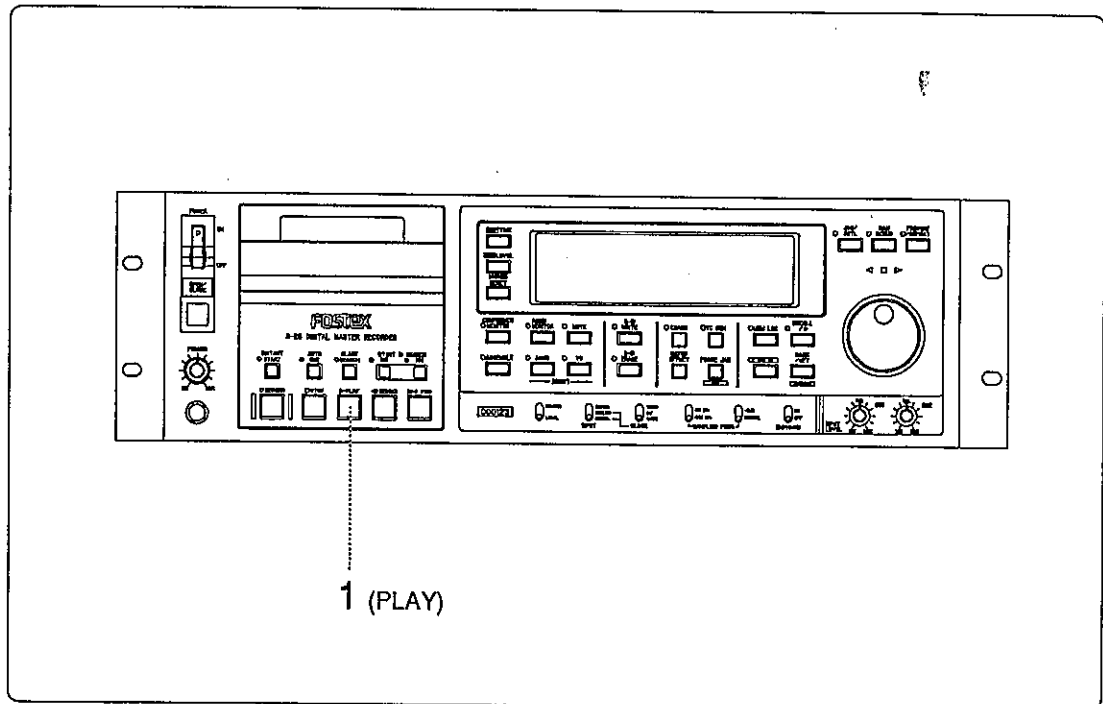

Operating Procedure

1. Press the PLAY button.

The PLAY button LED will light, and playback of the tape will start.

<NOTE>

The [EMPHASIS], [48kHz] or [44.1kHz] segment of the display will blink when emphasis and FS information recorded on tape is not in agreement with the D-25 switch setting.

Emphasis is handled automatically, but proper playback cannot be anticipated if FS information on the tape and the switch setting do not agree. Change the position of the SAMPLING FREQ switch of this machine if [48kHz] or [44.1kHz] blinks.

4-7. Various Playbacks

Playback modes that D-25 offers are explained here.

- * Cuing in the JOG/SHTL mode
- * Cuing in the RAM SCRUB mode
- * S-ID search
- * Time locate

4-7-1. Cuing in The JOG/SHTL Mode

In the JOG/SHTL mode, cuing is possible with the JOG and SHUTTLE dials while listening to playback of taped materials at the speeds of 1/2X to 1X or 1/2X to 16X in rewind and fast forward directions.

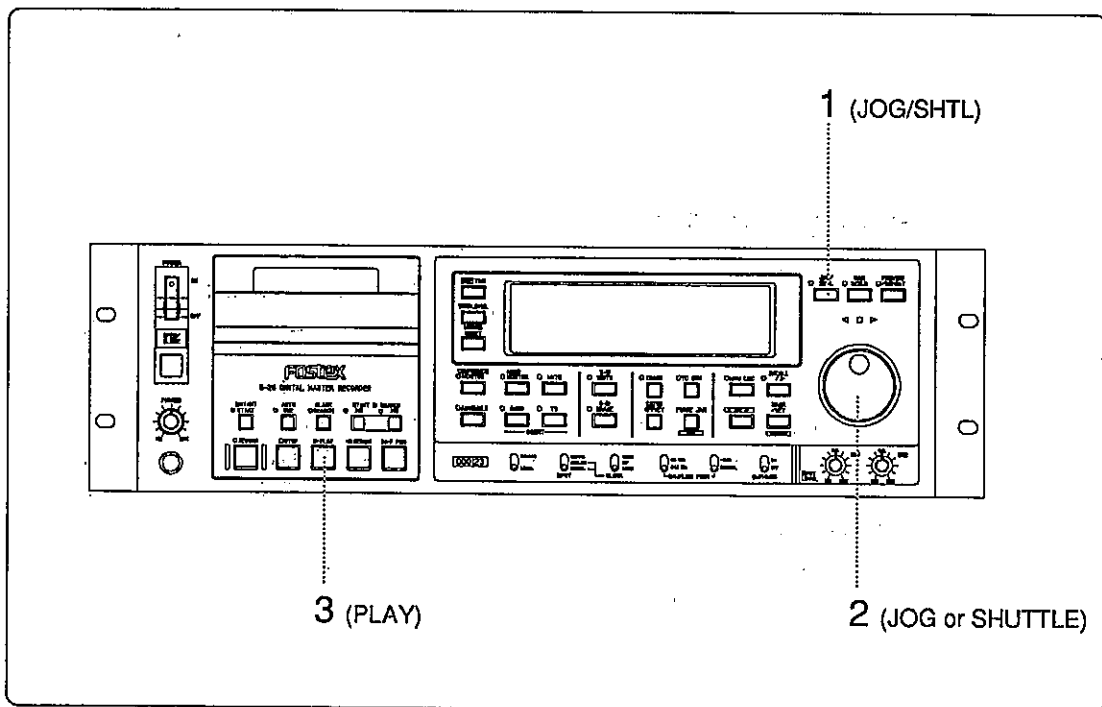

Operating Procedure

1. Press the JOG/SHTL key while in either the PLAY or STOP/PAUSE mode.

The JOG/SHTL key LED will light. The JOG/SHTL mode will turn on, and STILL results.

2. Start cuing manipulating the JOG or SHUTTLE dial.

The JOG and SHUTTLE dials function as follows:

JOG dial	Cuing at 1/2 to 1 time speed
SHUTTLE dial	Cuing at 1/2 to 16 times speed

3. After completion of cuing or search, press the PLAY button.

The JOG/SHTL mode will be released, and playback will start at that point.

- * Pressing of any one of the transport buttons except PLAY will stop the JOG/SHTL mode.

4-7-2. Cuing in The RAM SCRUB Mode

In the RAM SCRUB mode, cuing is possible at the speeds of 0X to 1X in the rewind or fast forward direction. Unlike the JOG/SHTL mode, the RAM SCRUB mode makes it possible to cue while listening to recorded sound on RAM (*).

(*) Sound Recorded on RAM

Audio data will be recorded in RAM five seconds before and after the point where the RAM SCRUB key was pressed (approximately 10 seconds in total).

Cuing can be performed using this 10 second data in the RAM SCRUB mode.

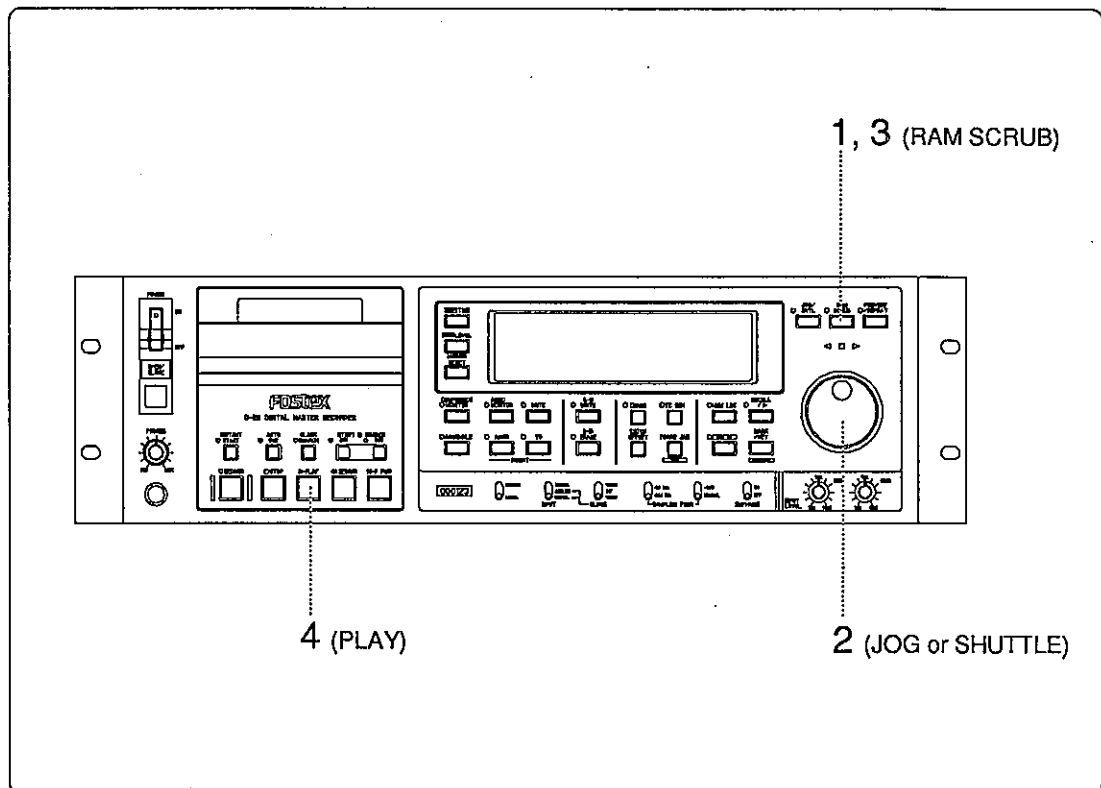

Operating Procedure

1. Press the RAM SCRUB key while in the PLAY or STOP/PAUSE mode.
The RAM SCRUB key LED will light. The RAM SCRUB mode will be turned "ON", and STILL will result.
2. Start cuing by manipulating the JOG or SHUTTLE dial.
Cuing of 0 to 1X speed is possible in the RAM SCRUB mode with the JOG and SHUTTLE dials.

Advantage of RAM SCRUB

By manipulating the JOG dial, cuing (digital scrub) with accuracy smaller than a frame is possible with 1X speed playback maintained. By turning the SHUTTLE dial, cuing (analog scrub) is possible at playback speed depending on the dial pointer position (angle of turn).

3. Press the RAM SCRUB key again if the playback capacity on RAM is too little.
Audio data will be re-loaded for 5 seconds before and after the pressing of the RAM SCRUB key.

4. After finish cuing, press the PLAY button.

The RAM SCRUB mode will be released. Playback will start from the cued point.

- * Press any one of the transport buttons except PLAY to release the RAM SCRUB mode.

4-7-3. S-ID Search

The S-ID search function makes it possible to search for an S-ID recorded on the tape, allowing for quick search for the desired S-ID.

The S-ID search function is also used to erase S-ID. The following details the search and play procedure using the S-ID search function.

- * For erasure of S-ID, refer to chapter 5, SUB-ID recording and erasure.

<NOTE>

This function does not work if there is no S-ID recorded on the tape.

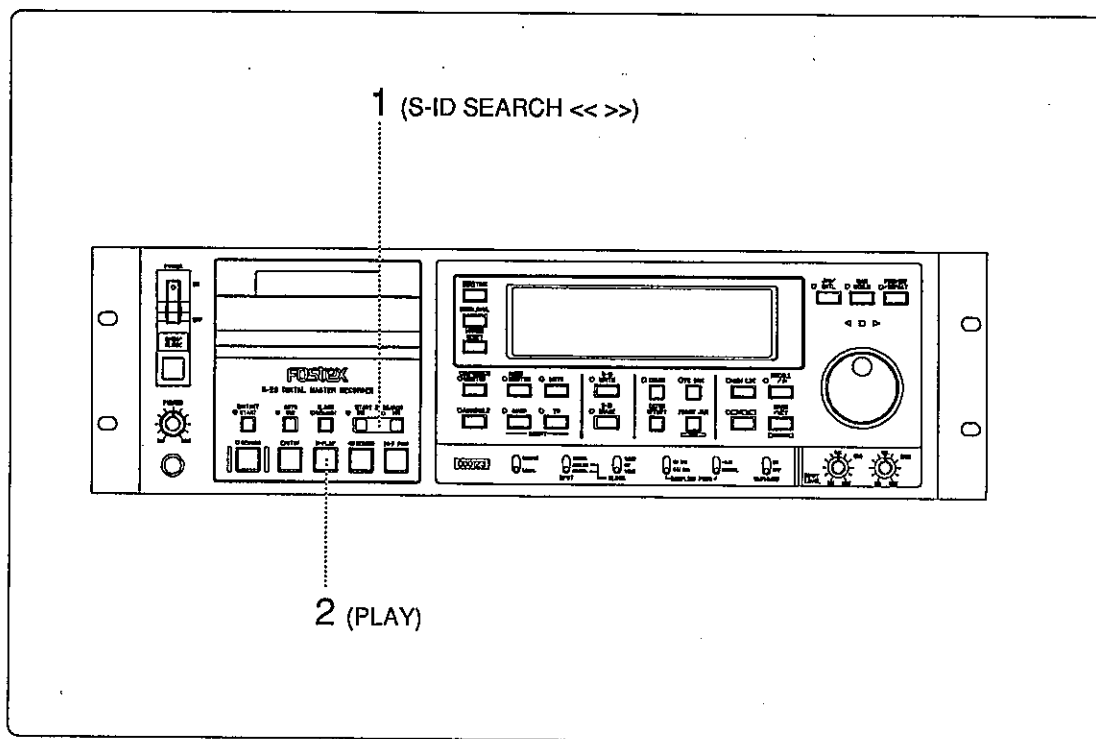

Operating Procedure

1. While in the STOP/PAUSE or PLAY mode, press START ID SEARCH (<<>>) as many times as the number to be searched.

The LEDs of the keys pressed will light. The D-25 will work as follows:

If the >> key is pressed	Search will be conducted in the fast forward direction as many times as the number of presses of the key. The PAUSE mode will be activated one second before the desired S-ID. While a search is under way, the >> key LED and FWD button lamp will light. They will go off as soon as the search is completed. The display will show the number of presses of the key with positive figures (with no + designator included). This number will decrease as the S-ID search is completed.
If the << key is pressed	Search will be conducted in the rewind direction as many times as the number of presses of the key. The PAUSE mode will be activated one second before the desired S-ID. While search is under way, the << key LED and REWIND button lamp will light. They will go off as soon as search is completed. The display will show the number of presses of the key with a minus (-) sign. This number will increase as the S-ID search is completed.

2. While searching, press the PLAY button.

After completion of searches, the located S-ID will be automatically played from the beginning of it.

4-7-4. Time locate

Locating to any A-TIME or TC recorded on the tape is possible with this function. The locating time can be either registered in advance as the locate memory data or edited before-hand. The procedure is described below:

Registration With The MARK/SET Key

If the MARK/SET key is pressed while the tape is running or in pause, the time of the point of the press (A-TIME or TC) will be registered as the memory locate data.

If A-TIME is on the display, that A-TIME data will be registered. Should TC be displayed instead, this TC will be registered.

<NOTE>

The D-25 holds one set of memory data at a time. Press the MARK/SET key to clear previous data. The new data available at the moment of pressing will be entered in the memory.

Registration of Edited Data

When in the data edit mode in memory locate, any time data can be input.

Data editing can be accomplished in the data edit mode by pressing the RECALL/> key followed by a press of the MEM LOC key.

* Refer to chapter 7, DATA EDIT MODE, for details of data editing.

Memory Locate Operation

Locating to the time stored in the memory

Locating will be carried out to the currently stored time.

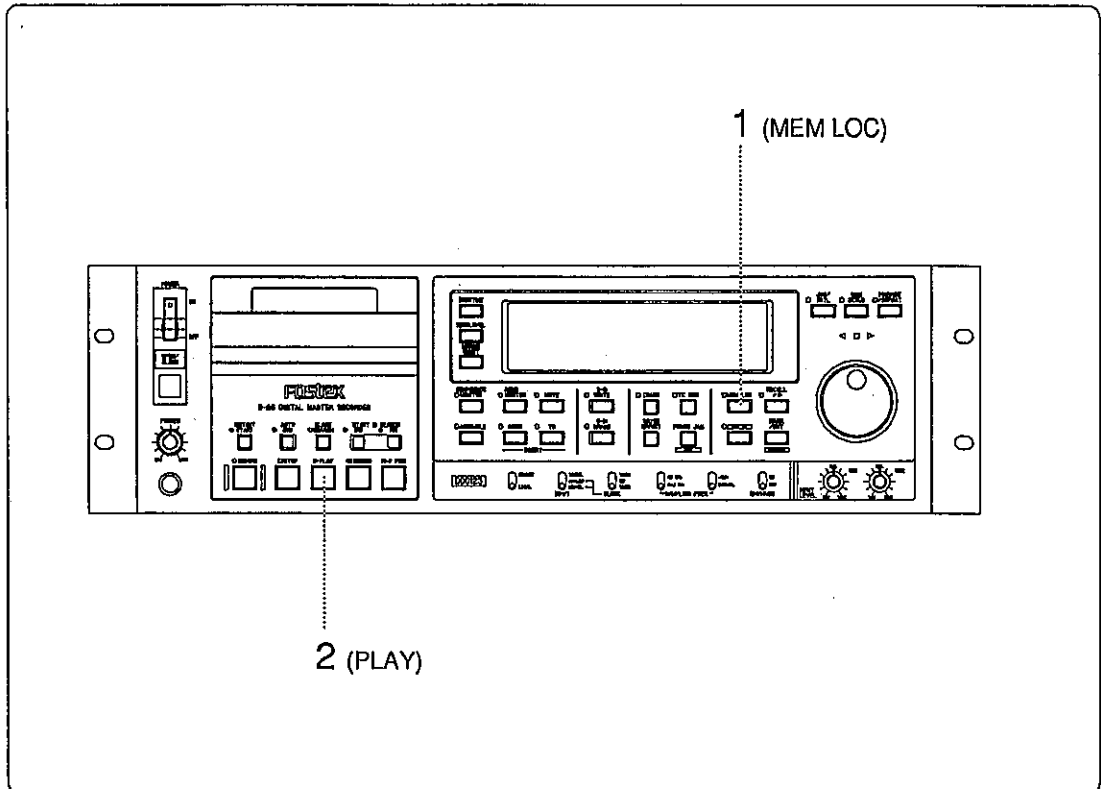

Operating Procedure

1. Press the MEM LOC key.

The time in the memory to appear on the display, and locating to the time will start in either rewind or fast forward.

The MEM LOC key LED will light during locating. This LED will go off as soon as locating finishes.

2. During locating, press the PLAY button.

When locating finishes, play will start automatically.

Locating to an Input Time

The D-25 will locate to the time set.

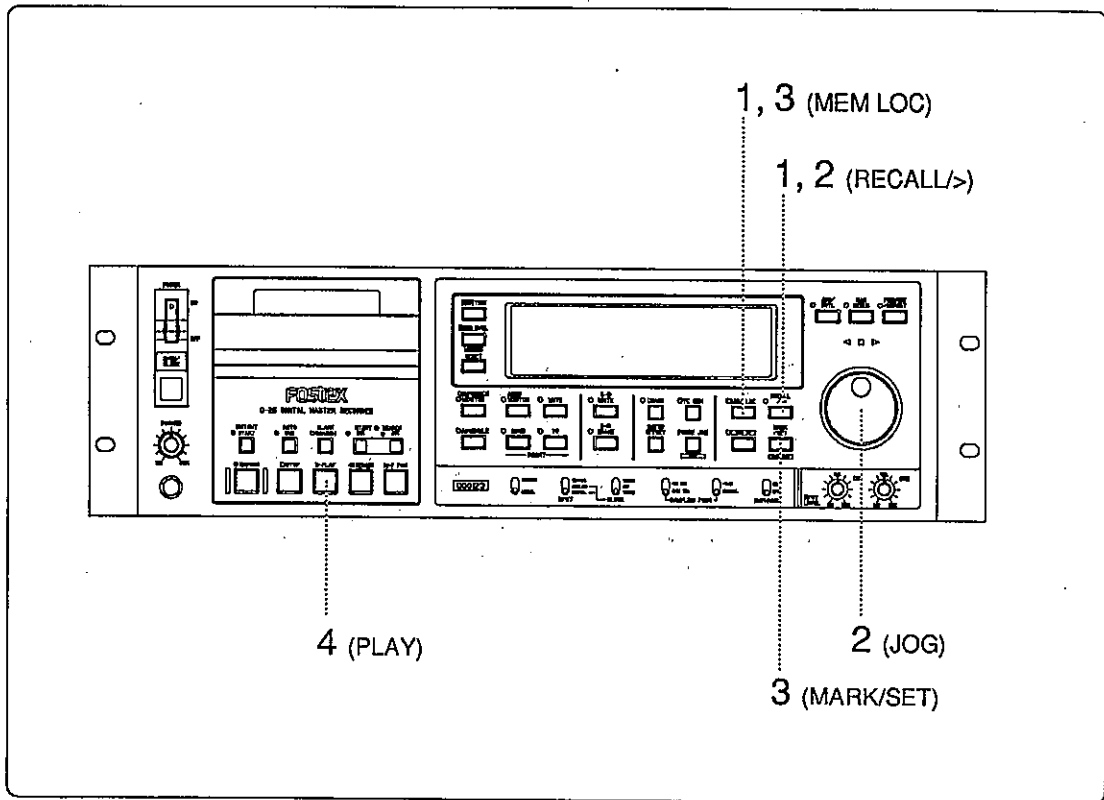

Operating Procedure

1. Turn the RECALL key "ON", and then the MEM LOC key.
The data edit mode in memory locate will be enabled. The display will show the currently registered time data, which are ready for editing. ([00H:00M:00S:00F] will be displayed in the event no data is registered.)
2. Enter the desired time.
The RECALL/> key will shift the edit point. Numbers can be entered with the JOG dial.
3. After entry, perform either one of the following operations.

MARK/SET key → MEM LOC key	The time entered will be registered as new memory data, and locating to that time will be initiated.
MEM LOC key:	Previously entered data will remain. The time entered will be located to.

* In all cases described above, when locating is finished, the D-25 will pause at the located time.

4. During locating, press the PLAY button.
When locating is finished, play will start automatically at the located time.

4-8. INSTANT START Mode

Use the INSTANT START mode to play back sound with instant output. The D-25 is equipped with a RAM function. This RAM can record about 10 seconds of audio data, which makes INSTANT START possible.

Use of this mode makes playback rise time shorter than normal.

When memory locate or S-ID search using the INSTANT START mode is performed, INSTANT START will commence at the designated time or from the beginning of the S-ID.

4-8-1. INSTANT START Operation

<NOTES>

- * INSTANT START can only be performed on A-TIME recorded tape.
- * INSTANT START can be performed only when the INSTANT START key LED is on.

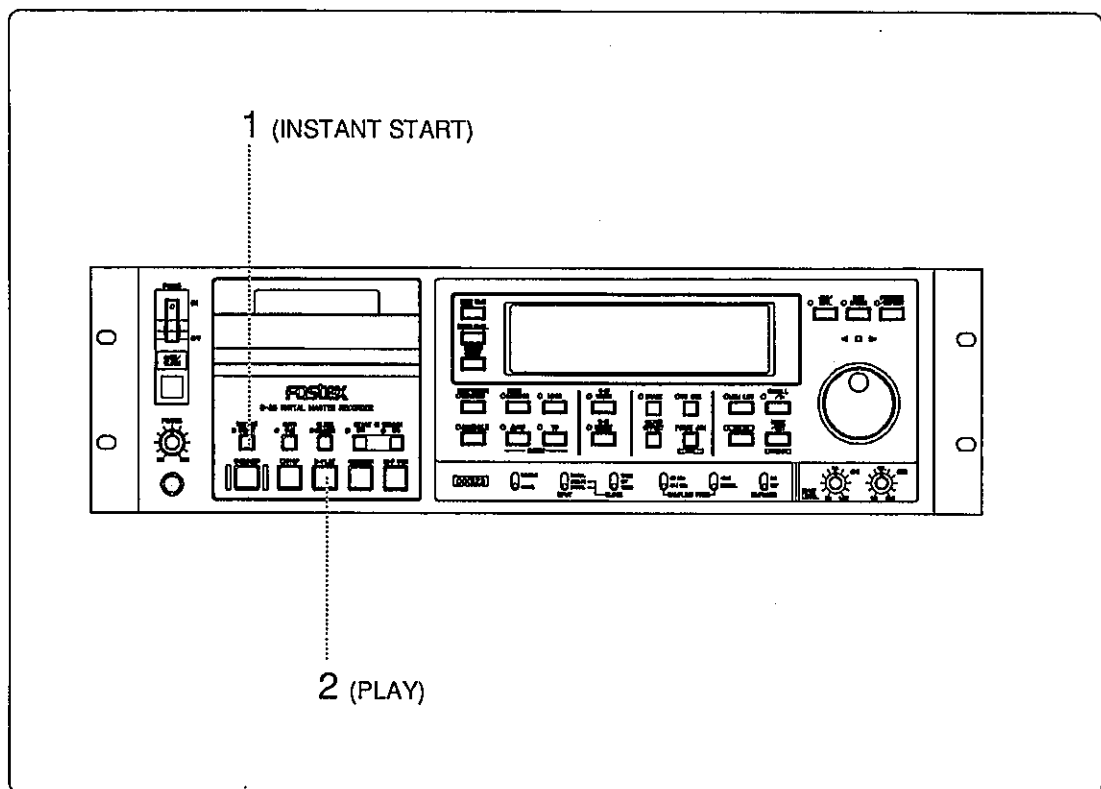

Operating Procedure

1. Press the INSTANT START key to turn on the INSTANT START mode. The D-25 will always respond automatically to execute INSTANT START instructions when in the INSTANT START mode. However, when the LED is blinking at a normal or fast speed, instant start instructions will not be accepted for the following reasons:

Fast blinking:	No A-TIME is recorded on tape.
Normal blinking:	Audio data is in the process of storing into RAM. Wait for the light to remain on.

2. After the LED lights solidly, press the PLAY button. Playback will start instantly (INSTANT START).

4-8-2. Execution of INSTANT START After Shift of Start Point

INSTANT START can be initiated at any point shifted with the RAM SCRUB mode.

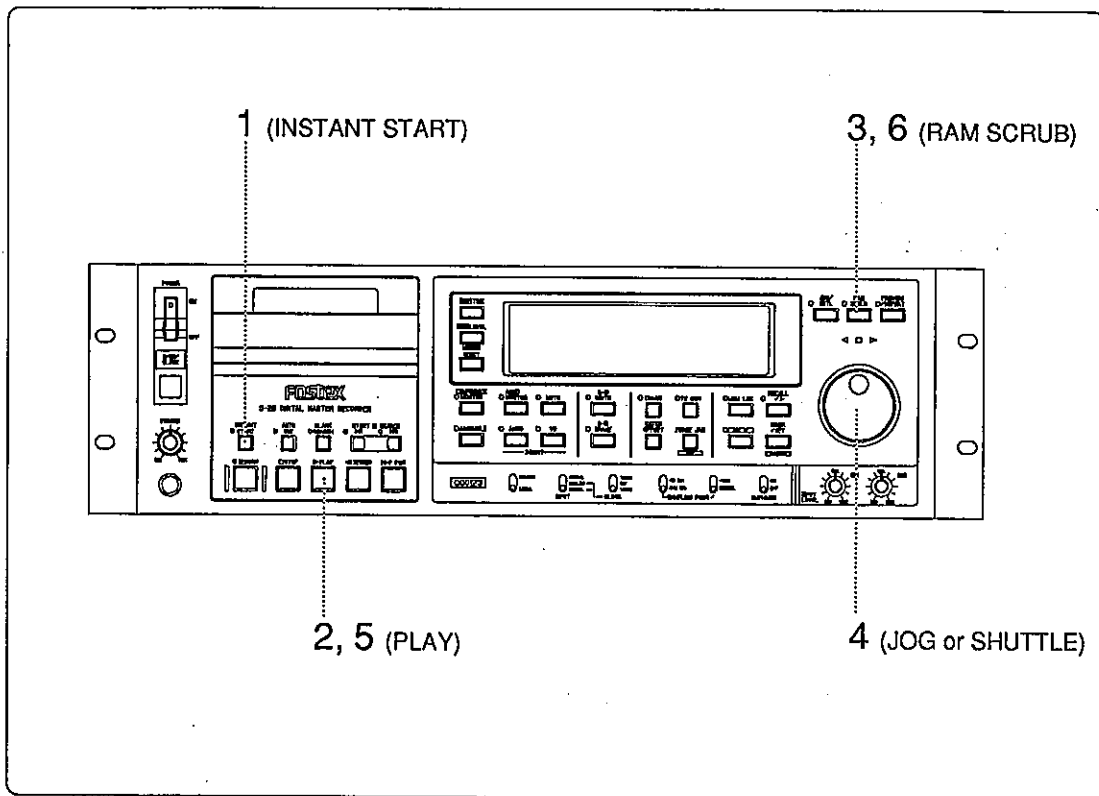

Operating Procedure

1. Press the INSTANT START key to turn the INSTANT START mode on.
The INSTANT START key LED will light.
2. Press the PLAY button to start playback.
3. Press the RAM SCRUB key at the point where INSTANT START is desired to commence.
The RAM SCRUB mode will turn on. Audio data existing within 5 seconds (10 seconds in total) before and after the point where the RAM SCRUB key was pressed will be stored in RAM. As soon as storage is completed, STILL will result.
4. Shift the start point by manipulating the JOG or SHUTTLE dial.
5. Press the PLAY button.
INSTANT START will be initiated from the shifted start point.
6. For additional start point shifts, repeat the above steps 3 and 4.

4-8-3. Rehearsal of INSTANT START With The PREVIEW/REPEAT Key

The INSTANT START point can be shifted by repeat-rehearsal if the previous procedure encounters some difficulty in accurately identifying the start point of sound. INSTANT START can be executed at an accurate start point located through rehearsal done by using the PREVIEW/REPEAT key.

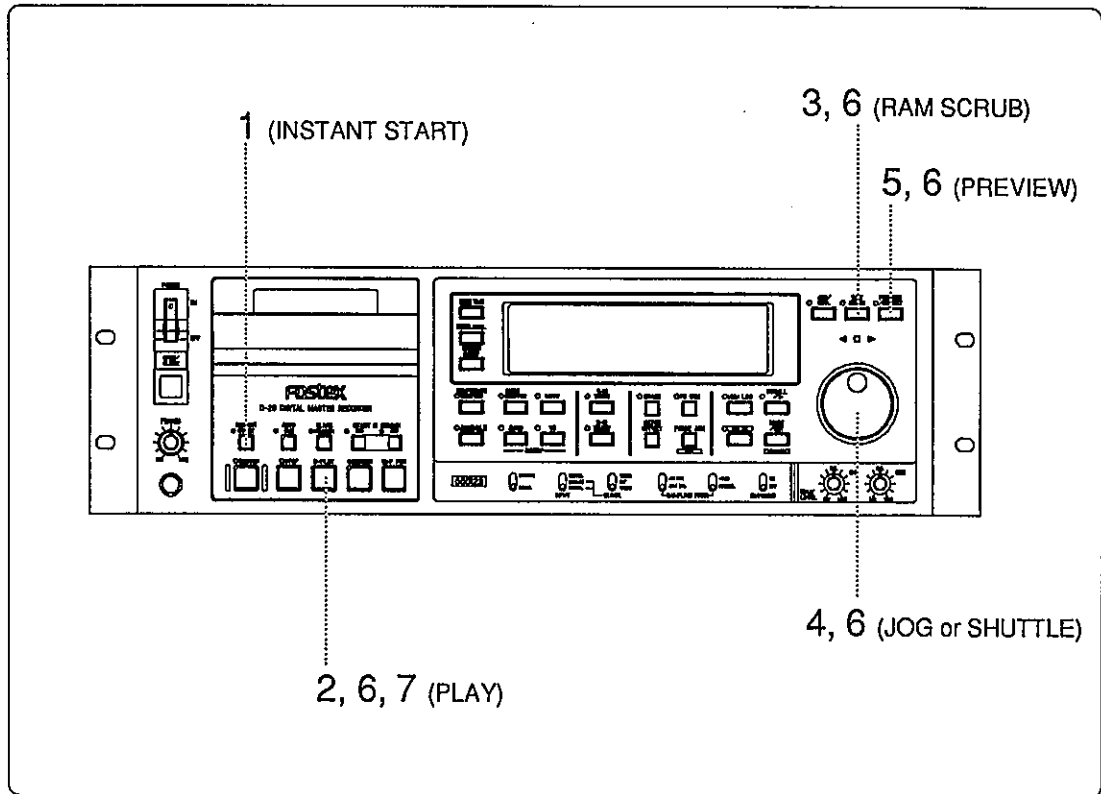

Operating Procedure

1. Press the INSTANT START key to turn the INSTANT START mode on.
The INSTANT START key LED will light.
2. Press the PLAY button to start playback.
3. Press the RAM SCRUB key at the point where INSTANT START is desired.
The RAM SCRUB mode will turn on. Audio data existing within 5 seconds before and after the point (10 seconds in total) where the RAM SCRUB key was pressed will be stored in RAM. STILL will result as soon as storage is completed.
4. Shift the start point by manipulating the JOG or SHUTTLE dial.
5. Press the PREVIEW key.
Pressing the PREVIEW key will cause RAM playback to be performed for about two seconds starting from the shifted start point, then stop. Another press of the PREVIEW key during rehearsal will activate the REPEAT mode causing rehearsal to repeat for about one second.
6. Repeat steps two through five above if you wish to perform more rehearsals with shifted start points.
7. After rehearsal is finished, press the PLAY button.
INSTANT START will take place at the accurate start point shifted in rehearsal.

4-8-4. Locate/Search Using the INSTANT START Function

Use the procedure for normal use for memory locate and S-ID search in the INSTANT START mode. Played back sound, however, will rise faster than normal when the INSTANT START mode is used.

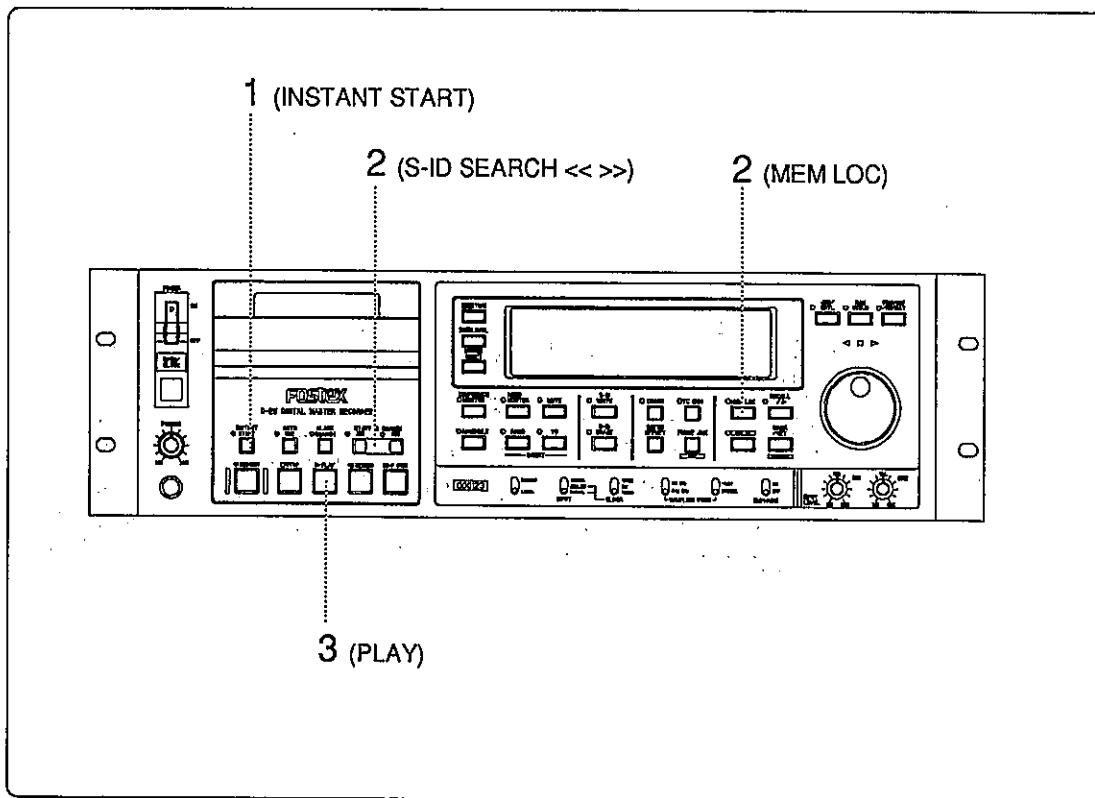

Operating Procedure

1. Press the INSTANT START key to turn the INSTANT START mode on.
2. Press either the MEM LOC key or S-ID SEARCH (<< >>) key.

Execution of the locate/search function will be as follows:

Execution of memory locate	Locating to the memory point will begin. Audio data around the located point will be recorded in the RAM. The D-25 will pause in INSTANT START.
Execution of S-ID search	S-ID searches will be performed for as many times as the number of times the S-ID SEARCH (<< >>) key is pressed. Audio data around the S-ID located will be recorded in the RAM. The D-25 will pause in INSTANT START.

3. After completion of locate/search function, press the PLAY button. INSTANT START will take place at the located or searched point.

<NOTE>

INSTANT START will automatically commence after completion of locate/search if the PLAY button has been pressed during the locate/search action.

* Normal S-ID search when the INSTANT START mode is used are shown below :

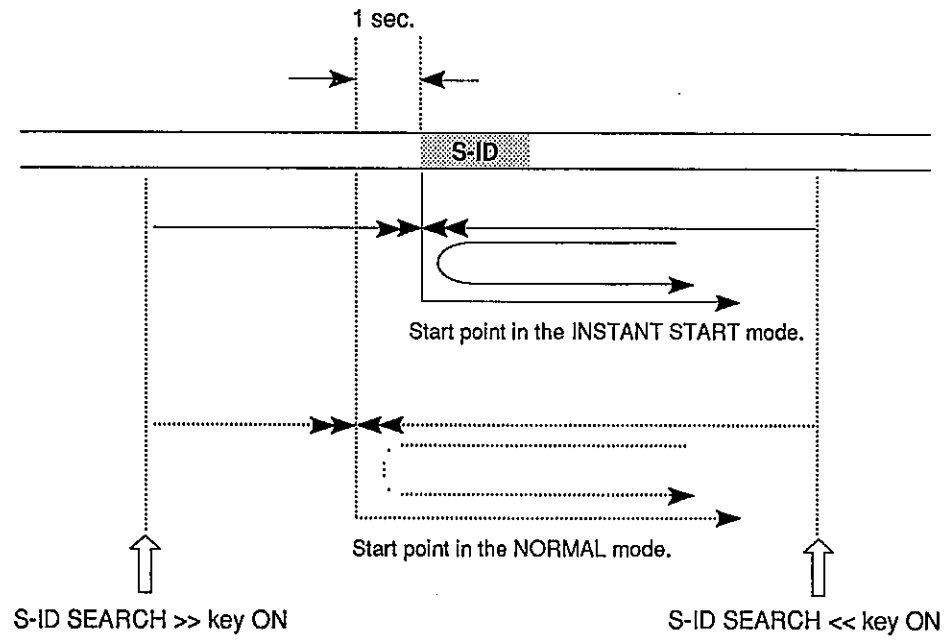

4-9. AUTO CUE Mode

AUTO CUE is a function that enables automatic identification of sound rise-up points (*) from no-recorded sections after a no-sound area and located near recorded S-ID. This allows for INSTANT START at the sound rise-up point.

(*) Sound rise-up point

The point where a signal stronger than the background reference level is recorded after a no-recorded section lasting 1 or more seconds.

Default value of the reference level is -40dB. This level can be altered in the SETUP mode as needed.

* For reference level alteration instruction, refer to chapter 9, SETUP Mode.

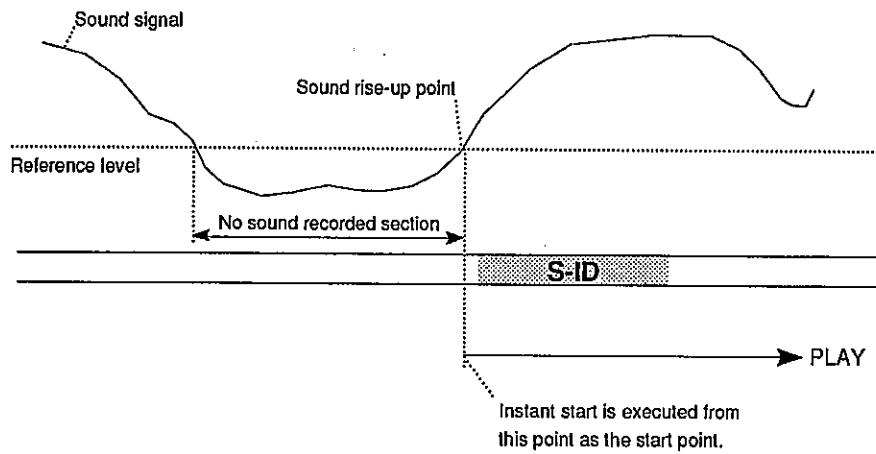

4-9-1. S-ID Search Using The AUTO CUE Mode

By using AUTO CUE mode for S-ID search, sound rise-up points around S-ID_i will be retrieved and INSTANT START performed.

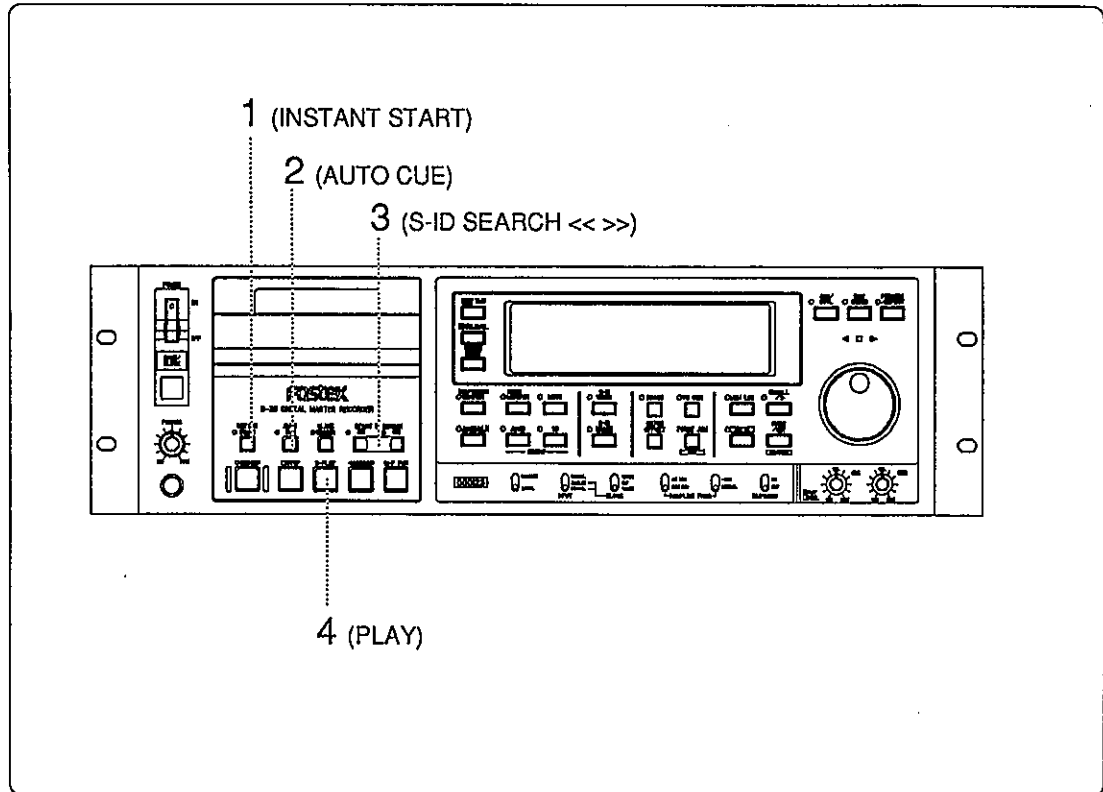

Operating Procedure

1. Press the INSTANT START key to turn the INSTANT START mode on.
2. Press the AUTO CUE key to turn the AUTO CUE mode on.
3. Press the S-ID SEARCH (<< >>) key to start S-ID search.
4. After search is completed, press the PLAY button.
 - INSTANT START will begin at the sound rise-up point.

<NOTE>

If the PLAY button is pressed during the search action, INSTANT START will automatically begin at the sound rise-up point after completion of the search.

MEMO

Series of horizontal dotted lines for writing.



Chapter 5

SUB-ID Recording and Erasure

This chapter details Sub-ID recording and erasing.
The D-25 can record or erase the Start-ID (S-ID and P-NO).

Chapter 5 SUB-ID Recording and Erasure

5-1. S-ID/P-NO Recording.....	5-1
5-1-1. Automatic S-ID/P-NO Recording During Audio Signal Recording (AUTO-ID Function).....	5-2
5-1-2. Manual S-ID/P-NO Recording During Audio Signal Recording.....	5-4
5-1-3. Manual S-ID/P-NO Recording while Playing Back Sound-Recorded Tape.....	5-6
5-1-4. S-ID/P-NO Recording by Cuing the JOG/SHTL or RAM SCRUB Mode.....	5-8
5-1-5. S-ID Recording with NEXT P-NO Input During Sound Recording or Playing Back.....	5-10
5-1-6. Recording of P-NO Continuous from the Head of Tape (Renumbering Function).....	5-12
5-2. S-ID/P-NO Erasure.....	5-14

5-1. S-ID/P-NO Recording

Six options as follows are available for recording S-ID/P-NO on the D-25.

- * **Automatic recording during audio signal recording (AUTO-ID function).**
- * **Recording at any point of your choice during audio signal recording.**
- * **Recording at any point of your choice while playing sound recorded tape.**
- * **Recording of a NEXT P-NO at any point of your choice after it is set.**
- * **Recording of an S-ID/P-NO by cuing in either the JOG/SHTL or RAM SCRUB mode.**
- * **Recording of the renumbered P-NO in a sequential order from the beginning.**

<IMPORTANT>

In sub code editing such as at record/erase of S-ID and renumbering, if INT generator is on or external time code is being input, these time codes will be recorded at the editing point (S-ID record/erase section). As a result, continuity of the time code will be lost. Therefore, in sub code editing, switch off the INT generator or do not connect anything to the TIME CODE IN connector.

5-1-1. Automatic S-ID/P-NO Recording During Audio Signal Recording (AUTO-ID function)

An S-ID/P-NO will be recorded automatically at any sound rise-up points in music while recording the audio signal.

<NOTES>

- * Recording of S-ID/P-NO is possible only in the assemble mode (confidence mode inclusive) and not in the audio-only insert mode.
- * No S-ID will be recorded at a sound-rise up point identified within less than nine seconds after the finish of sound recording. In the DAT format, S-ID recording time is nine seconds. The nine second period that follows immediately after the S-ID's nine recorded seconds is defined as the time for search action. Because of this convention, S-ID recording within that second nine second period after S-ID recording is not possible.
- * Because of the wide range of dynamics of classical music, unwanted S-ID may be recorded at low level portions of music. This problem can be avoided by changing the AUTO ID detecting level in SETUP mode "201- ****".
- * Audio signals or S-ID/P-NO cannot be recorded on tape cassettes with the erase protect hole open.

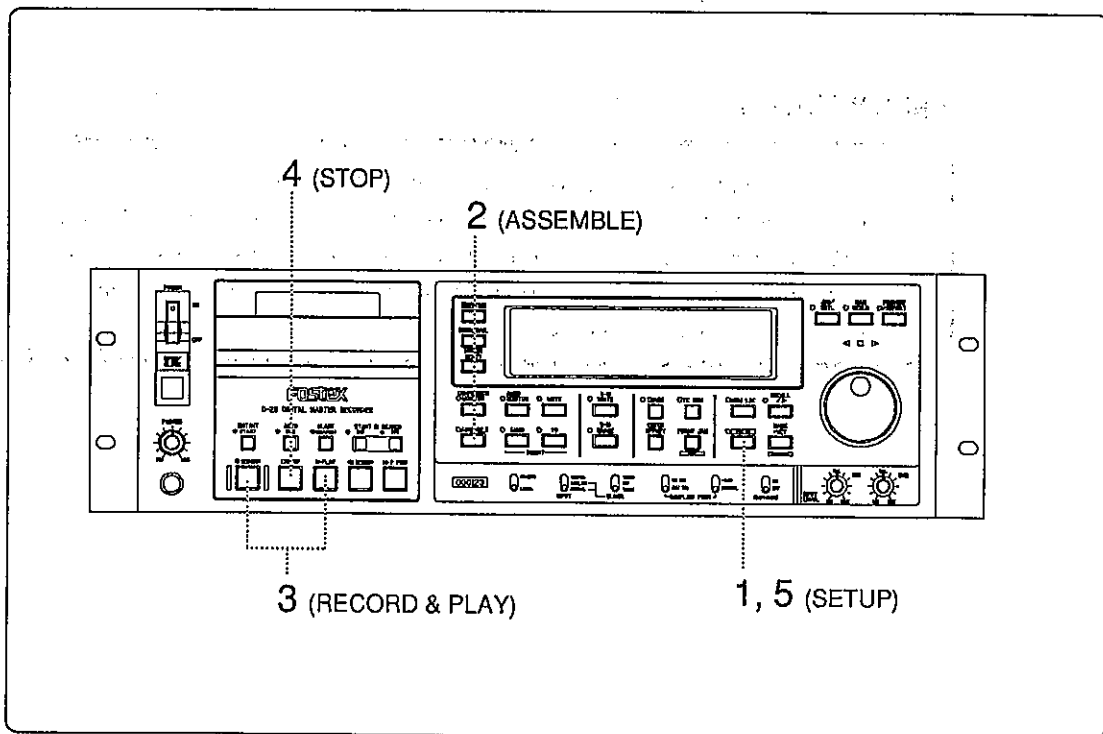

Operating Procedure

1. Set the AUTO ID function to on in the SETUP mode "106- ****".
Refer to Chapter 9, SETUP MODE, for details.
2. Press the ASSEMBLE key to turn the assemble mode on.
3. Hold the RECORD button and press the PLAY button to start sound recording.

An S-ID/P-NO will be recorded automatically at any point when a signal of greater magnitude than the background level (default or selected) is input after any no-recorded section lasting one second or longer during sound recording.

WRITE under way	
S-ID WRITE key LED	on
[S-ID]	lighting on the display
RECORD button	lighting
WRITE finished	
S-ID WRITE key LED	off
[S-ID]	light off
RECORD button	lighting

4. After completion of sound recording, press the STOP button to turn off the sound recording mode.
 5. Turn off the AUTO-ID function in the SETUP mode.
- * Should there be a P-NO displayed when recording starts, the P-NO for the current recording will automatically continue from that displayed number.

5-1-2. Manual S-ID/P-NO Recording During Audio Signal Recording

An S-ID/P-NO can be recorded at any point (the head of tune) while recording audio signals.

<NOTES>

- * This function works only when the sound recording mode is set to the assemble mode (including the confidence mode). No recording will be possible if the D-25 is set to the audio-only insert mode.
- * Audio signals or S-ID/P-NO cannot be recorded on tape cassettes with the erase protect hole open.

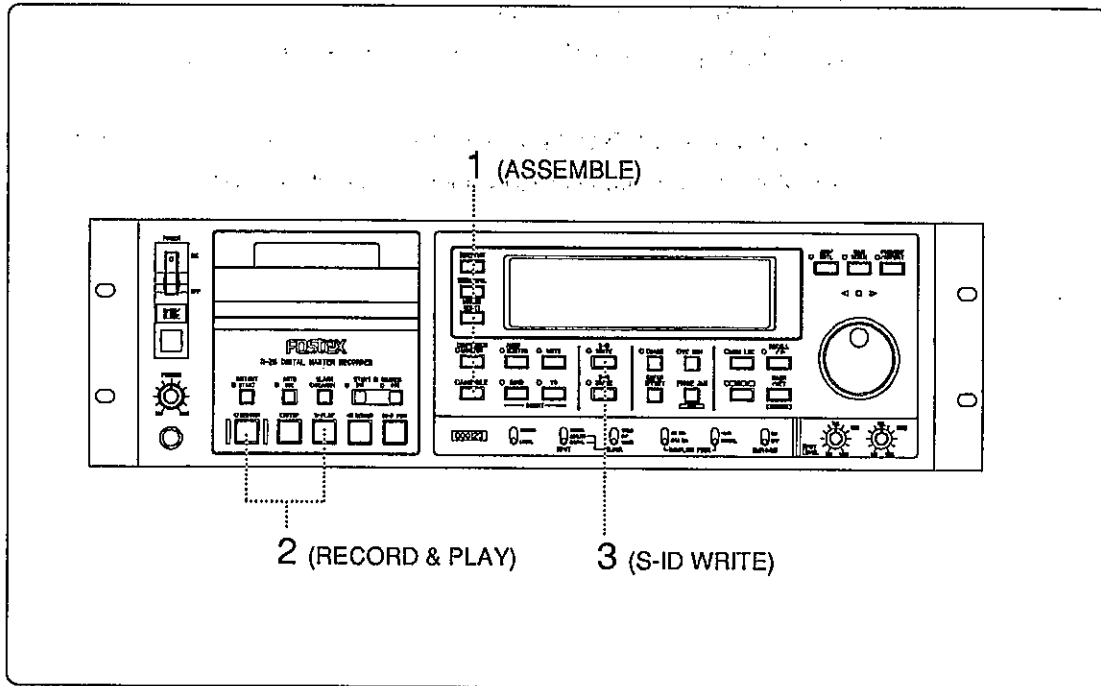

Operating Procedure

1. Press the ASSEMBLE key to turn on the assemble mode.
2. Hold the RECORD button and press the PLAY button to start sound recording.
3. Press the S-ID WRITE key at the point where an S-ID is desired.

The S-ID will be recorded at the point where the S-ID WRITE key is pressed, and sound recording will continue.

WRITE under way	
S-ID WRITE key LED	on
[S-ID]	lighting on the display
RECORD/PLAY button	lighting
WRITE finished	
S-ID WRITE key LED	off
[S-ID]	light off
RECORD/PLAY button	lighting

- * Should there be a P-NO displayed when recording starts, the P-NO for the current recordings will automatically continue from that displayed number.
- * When [----] is shown in the display, P-NO will not be recorded, but S-ID will. If a NEXT P-NO is designated, the P-NO will be recorded together with S-ID.
- * Refer to the oncoming paragraph 5-1-5. for how to record the designated NEXT P-NO.

5-1-3. Manual S-ID/P-NO Recording While Playing Back Sound-Recorded Tape

It is possible to record an S-ID/P-NO at any point while playing back sound-recorded tape.

<IMPORTANT>

In sub code editing such as at record/erase of S-ID and renumbering, if INT generator is on or external time code is being input, these time codes will be recorded at the editing point (S-ID record/erase section). As a result, continuity of the time code will be lost. Therefore, in sub code editing, switch off the INT generator or do not connect anything to the TIME CODE IN connector.

<NOTES>

- * This operation can only be carried out when the assemble mode is off and the TC insert mode is on. No other modes will accept this operation.
- * This operation cannot be carried out with no A-TIME on tape.
- * Tape cassettes with the erase protect hole open will not record.
- * S-ID will not be recorded in the INSTANT START mode, or if CONFIDENCE MONITOR is on.

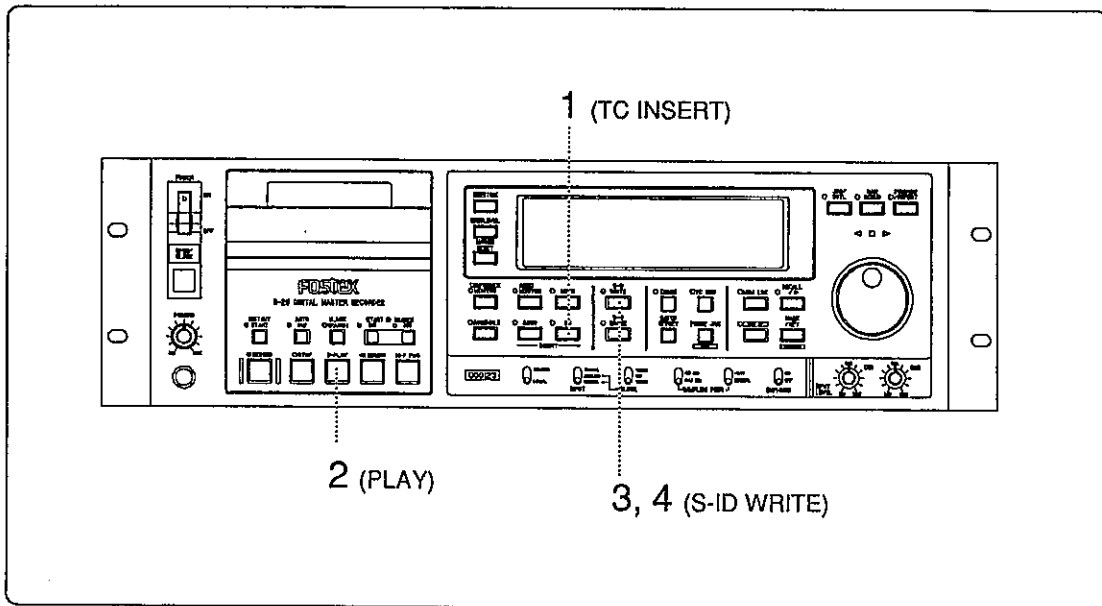

Operating Procedure

1. Press the TC INSERT key to turn on the TC insert mode.
2. Press the PLAY button to start tape playback.
3. Press the S-ID WRITE key at the point where S-ID recording is desired. An S-ID will be recorded at the point where the S-ID WRITE key is pressed and playback will continue.

WRITE under way	
S-ID WRITE key LED	on
[S-ID]	lighting on the display
RECORD/PLAY button	lighting
WRITE finished:	
S-ID WRITE key LED	off
[S-ID]	light off
RECORD button	light off

4. Repeat step 2, 3 above for the next S-ID recording.

- * Should there be a P-NO shown in the [PGM] display segment when recording starts, the P-NO for the current recording will automatically continue from that displayed number.
- * If [----] is shown in the display, a P-NO will not be recorded, but an S-ID will. If a NEXT P-NO is designated when recording, the P-NO will be recorded.
- * Refer to the oncoming 5-1-5. paragraph for how to record a designated NEXT P-NO.

5-1-4. S-ID/P-NO Recording by Cuing in The JOG/SHTL or RAM SCRUB Mode

A point to record S-ID/P-NO at can be accurately identified by using the JOG/SHTL or RAM SCRUB mode.

<IMPORTANT>

In sub code editing such as at record/erase of S-ID and renumbering, if INT generator is on or external time code is being input, these time codes will be recorded at the editing point (S-ID record/erase section). As a result, continuity of the time code will be lost. Therefore, in sub code editing, switch off the INT generator or do not connect anything to the TIME CODE IN connector.

<NOTES>

- * This operation cannot be executed without A-TIME on tape.
- * Operation cannot be executed on tape cassettes with the erase protect hole open.
- * Operation cannot be executed if the INSTANT START mode is on.

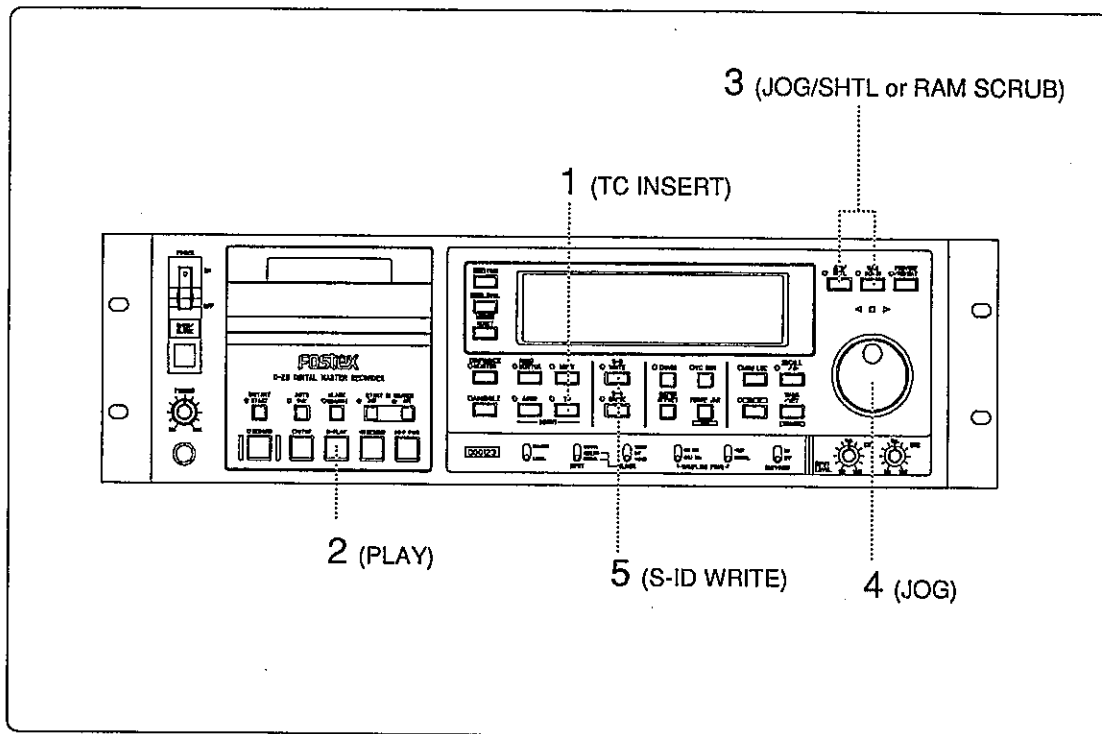

Operating Procedure

1. Press the TC INSERT key to turn on the TC insert mode.
2. Press the PLAY button to start tape playback.
3. Press the JOG/SHTL or RAM SCRUB key at the point where an S-ID is desired.
4. Accurately locate the recording point by manipulating the JOG dial.
5. After the point is located, press the S-ID WRITE key.

Pressing the S-ID WRITE key will cause the tape to preroll for about two seconds, and then to record an S-ID/P-NO.

WRITE under way	
S-ID WRITE key LED	on
[S-ID]	lighting on the display
RECORD/PLAY button	lighting
WRITE finished	
S-ID WRITE key LED	off
[S-ID]	light off
RECORD button	light off

6. For recording the next S-ID, repeat the step 2 ~ 5.

- * If there is a P-NO shown in the [PGM] display segment when recording starts, the P-NO for the current recording will automatically continue from the displayed number.
- * If [----] is shown in the display, a P-NO will not be recorded but an S-ID will.

5-1-5. S-ID Recording With NEXT P-NO Input During Sound Recording or Playing Back

While recording audio signals or playing recorded tape back, S-ID/P-NO can be recorded by inputting NEXT P-NO (any P-NO) in the data edit mode.

<IMPORTANT>

In sub code editing such as at record/erase of S-ID and renumbering, if INT generator is on or external time code is being input, these time codes will be recorded at the editing point (S-ID record/erase section). As a result, continuity of the time code will be lost. Therefore, in sub code editing, switch off the INT generator or do not connect anything to the TIME CODE IN connector.

<NOTES>

- * This operation will not be carried out with no A-TIME recorded on tape.
- * You cannot record on tape cassettes with the erase protect hole open.

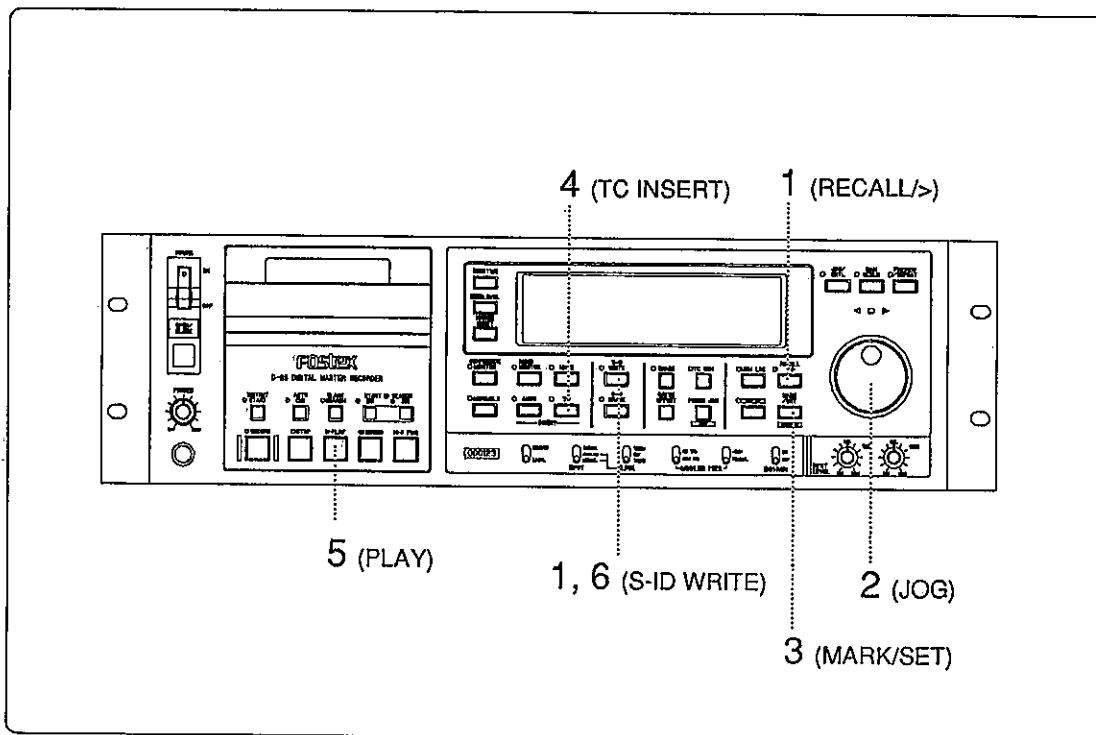

Operating Procedure

1. In STOP or PAUSE, press the RECALL key, and then the S-ID WRITE key.
NEXT P-NO data can be edited and entered.
2. Enter numbers by manipulating the JOG dial.
3. Press the MARK/SET key to establish the entered numerals as the NEXT P-NO.
The normal display will return, and the number just entered will be shown on the [PGM] segment of the display.

4. Press the TC INSERT key to turn on the TC insert mode.
5. Press the PLAY button to start playback.
6. Press the S-ID WRITE key at the point where an S-ID is desired.

The designated P-NO as well as S-ID will be recorded at the point where the key is pressed.

WRITE under way	
S-ID WRITE key LED	on
[S-ID]	lighting on the display
RECORD/PLAY button	lighting
WRITE finished	
S-ID WRITE key LED	off
[S-ID]	light off
RECORD button	light off

5-1-6. Recording of P-NO Continuous From The Head of Tape (Renumbering Function)

Program numbers (P-No) can be renumbered to run continuously from the beginning of the tape through the use of the renumbering function if the recorded numbers become discontinuous due to editing or other reasons.

The SETUP mode "601- EXC" takes care of the renumbering job.

<IMPORTANT>

In sub code editing such as at record/erase of S-ID and renumbering, if INT generator is on or external time code is being input, these time codes will be recorded at the editing point (S-ID record/erase section). As a result, continuity of the time code will be lost. Therefore, in sub code editing, switch off the INT generator or do not connect anything to the TIME CODE IN connector.

<NOTES>

- * When renumbering, transport must be in the STOP or PAUSE mode.
- * This operation can be carried out when both the assemble and insert modes are at the "OFF" position.
- * Tape cassettes with the erase protect hole open cannot be recorded.

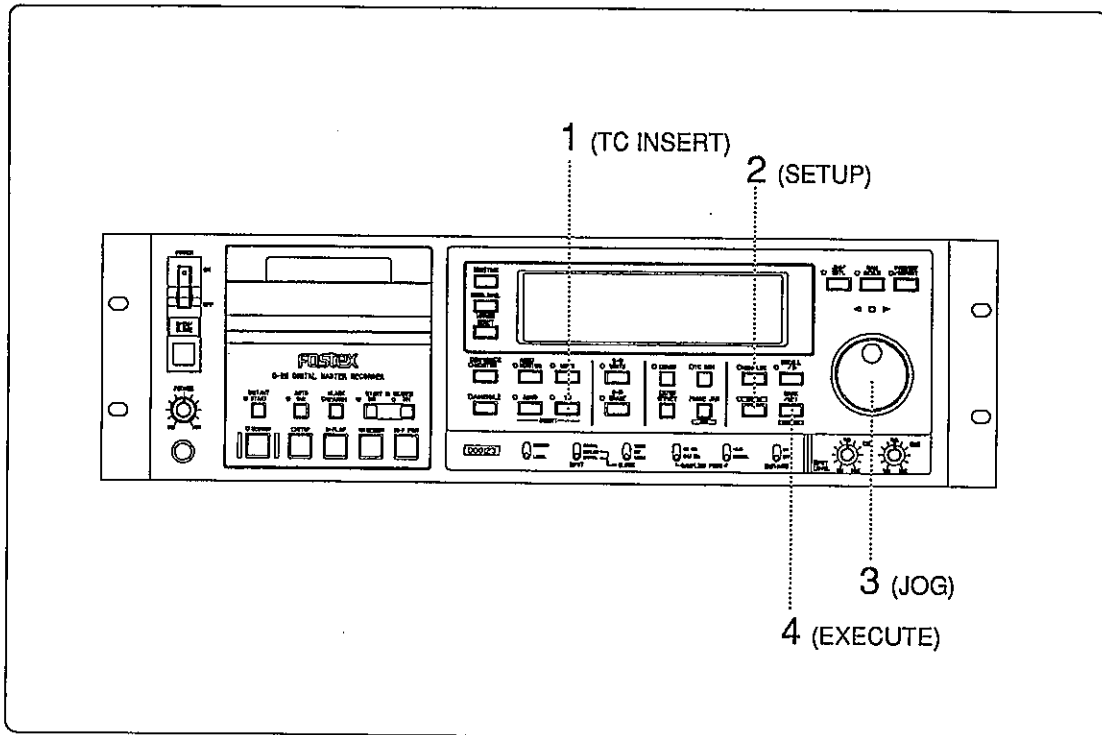

Operating Procedure

1. Press the TC INSERT key to turn on the TC insert mode.
2. Press the SETUP key to turn the SETUP mode on.
3. Recall the SETUP "601-EXC" menu with the JOG dial or the SETUP key.

4. Press the EXECUTE key twice.

The tape will rewind automatically to the beginning. Upon completion of rewinding, new P-NO will be recorded while automatically retrieving the recorded S-IDs.

The steps as described below will be repeated.

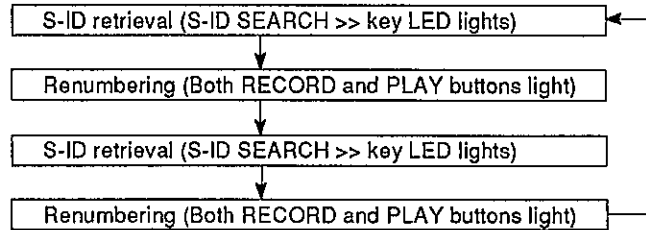

As soon as renumbering is completed, the tape will automatically rewind again to the beginning and the D-25 will pause.

- * Press the STOP button if you wish to stop renumbering halfway.

5-2. S-ID/P-NO Erasure

S-ID/P-NO which are no longer necessary can be erased.

<IMPORTANT>

In sub code editing such as at record/erase of S-ID and renumbering, if INT generator is on or external time code is being input, these time codes will be recorded at the editing point (S-ID record/erase section). As a result, continuity of the time code will be lost. Therefore, in sub code editing, switch off the INT generator or do not connect anything to the TIME CODE IN connector.

<NOTES>

- * Erasure of S-ID/P-NO must be executed with the transport in the STOP or PAUSE mode; otherwise erasure will not be accomplished.
- * Tape cassettes with the erase protect hole open cannot be recorded.

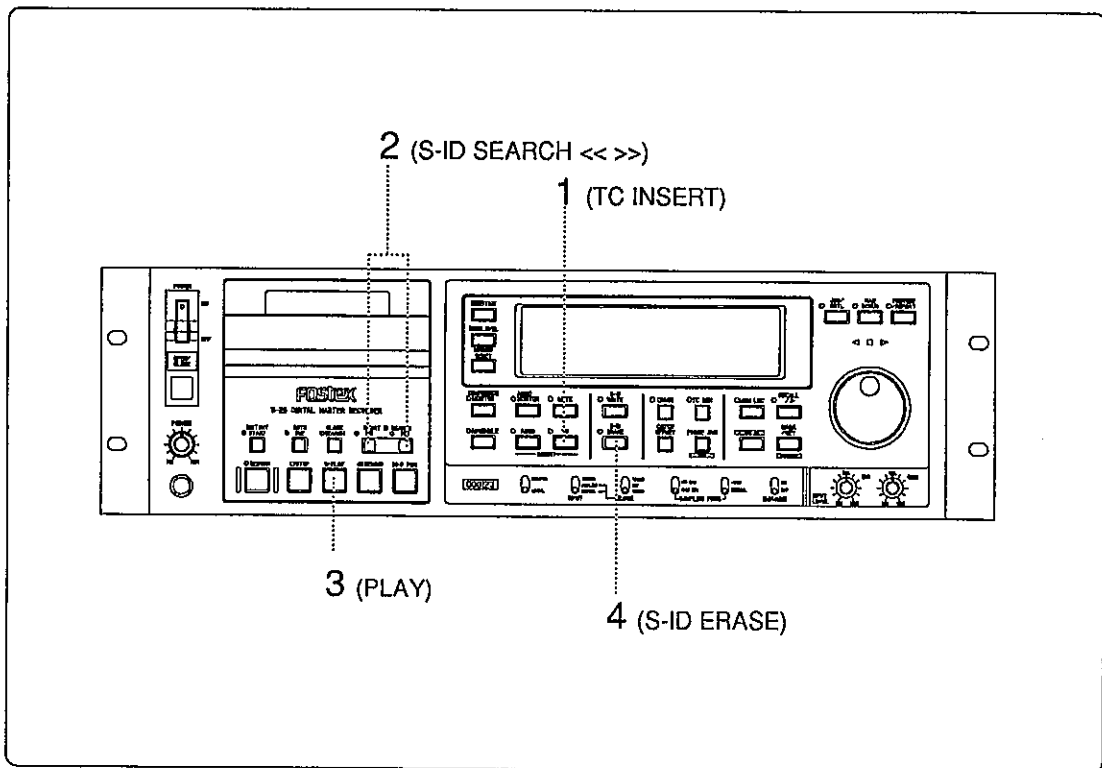

Operating Procedure

1. Press the TC INSERT key to turn on the TC insert mode.
2. Press the S-ID SEARCH(<<, >>) key to retrieve the S-ID you want to erase.
After completing the S-ID search, the [S-ID] segment of the display will light.
3. If [S-ID] is dark, press the PLAY button to run the tape until the point where [S-ID] lights.

4. Press the S-ID ERASE key.

When pressed, any S-ID/P-NO existing within two seconds prior to the point where the key is pressed will be erased with the audio signal being played back.

After erasure is completed, the D-25 will pause at the beginning of the area where the S-ID existed.

Erasure under way	
S-ID ERASE key LED	on
[S-ID]	light → dark
RECORD/PLAY button	lighting
Erasure finished	
S-ID ERASE key LED	off
[S-ID]	dark
RECORD button	dark

MEMO

A series of horizontal dotted lines for writing, spanning the width of the page.



Chapter 6

Time Code Recording

This chapter will explain the various methods of recording time code, an important component in audio editing.

Chapter 6 Table of Contents

6-1. Recording Time Code Generated by the INT Generator.....	6-2
6-1-1. Simultaneous Time Code Recording with Audio Signals.....	6-2
6-1-2. Time Code Recording on the Recorded with Audio Signals.....	6-4
6-1-3. Recording of Continuous Time Code Starting Halfway.....	6-6
6-2. Recording of Externally Supplied Time Code.....	6-7
6-2-1. Connections.....	6-7
6-2-2. Time Code Recording Operation.....	6-8

The D-25 uses SMPTE/EBU time code. SMPTE time code is applicable to the NTSC system, and EBU time code to the PAL and SECAM system.

There are two recording modes available for time code recording.

- * **Recording on blank tape:**
In the assemble mode, time code will be recorded simultaneously with audio signals.
- * **Recording on recorded tape:**
In the Insert mode, time code alone will be recorded.

Time code can be either the one generated by the internal generator built in the D-25 or one externally supplied.

6-1. Recording Time Code Generated by The INT Generator

This function records time code using the D-25's internal generator.

6-1-1. Simultaneous Time Code Recording with Audio Signals

Time code is recorded at the same time as audio signal in the assemble mode.

For connections to other equipment and operation, please refer to "Basic Audio Signal Recording".

* Time code recording can be done in ANALOG IN or DIGITAL IN.

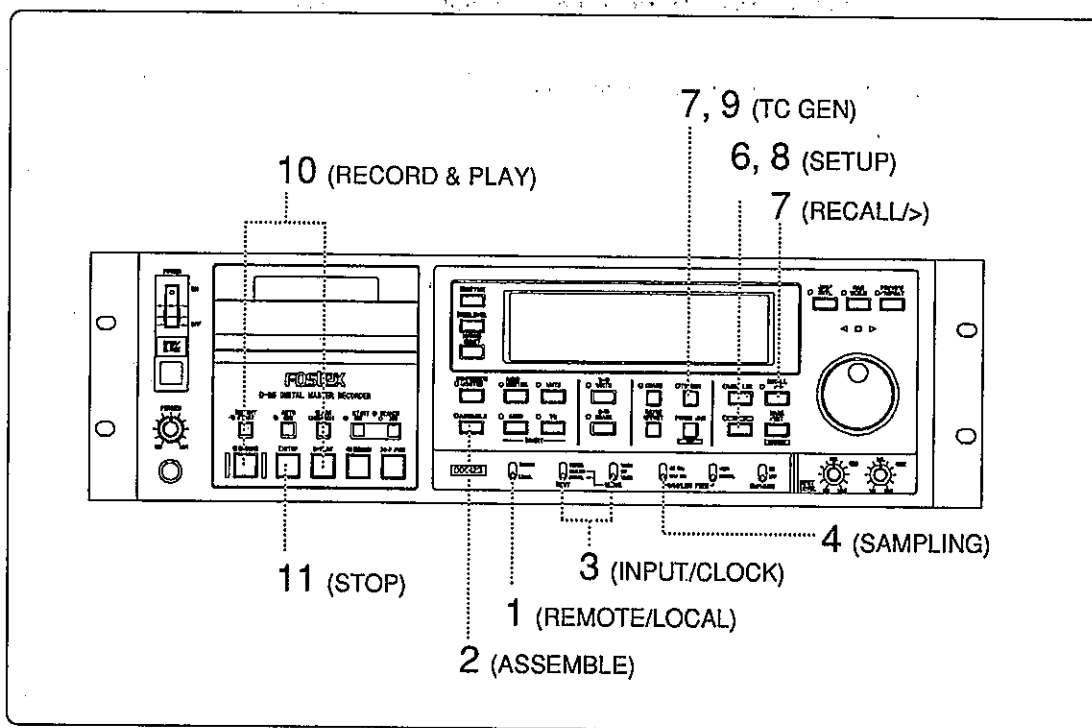

Operating Procedure

1. Set the REMOTE switch to the "LOCAL" position.
2. Press the ASSEMBLE key to turn the assemble mode on.
3. Set the INPUT selection switch to "ANALOG" position and the CLOCK switch to the "INT" position.
4. Set the SAMPLING switch to the desired frequency.
5. Set the EMPHASIS switch as needed.
6. Set RUN MODE of the INT generator to "FREE RUN".
Select "410- 000" (FREE RUN) in SETUP mode 410- ***.

* Refer to chapter 9 SETUP MODE, for details of the SETUP mode.

7. Preset GENERATOR TIME to [00H:00M:00S:00F].
Edit GENERATOR TIME in the data edit mode.

* Refer to chapter 7 DATA EDIT MODE, for details of the SETUP mode.

8. Set the frame rate of the time code to be recorded.

Select the desired frame rate in SETUP mode "402- ***".

* Refer to chapter 9 SETUP MODE, for details of the SETUP mode.

9. Press the TC GEN key to start the INT generator.

10. Hold the RECORD button and press the PLAY button to start sound recording.

11. After completion of sound recording (data recording), press the STOP button to stop the tape.

At the same time, press the TC GEN key to turn it off and stop the internal time generator.

6-1-2. Time Code Recording on Tape Recorded with Audio Signals

Using the following procedure, time code can be additionally recorded in the insert mode on tape that only carries audio signals.

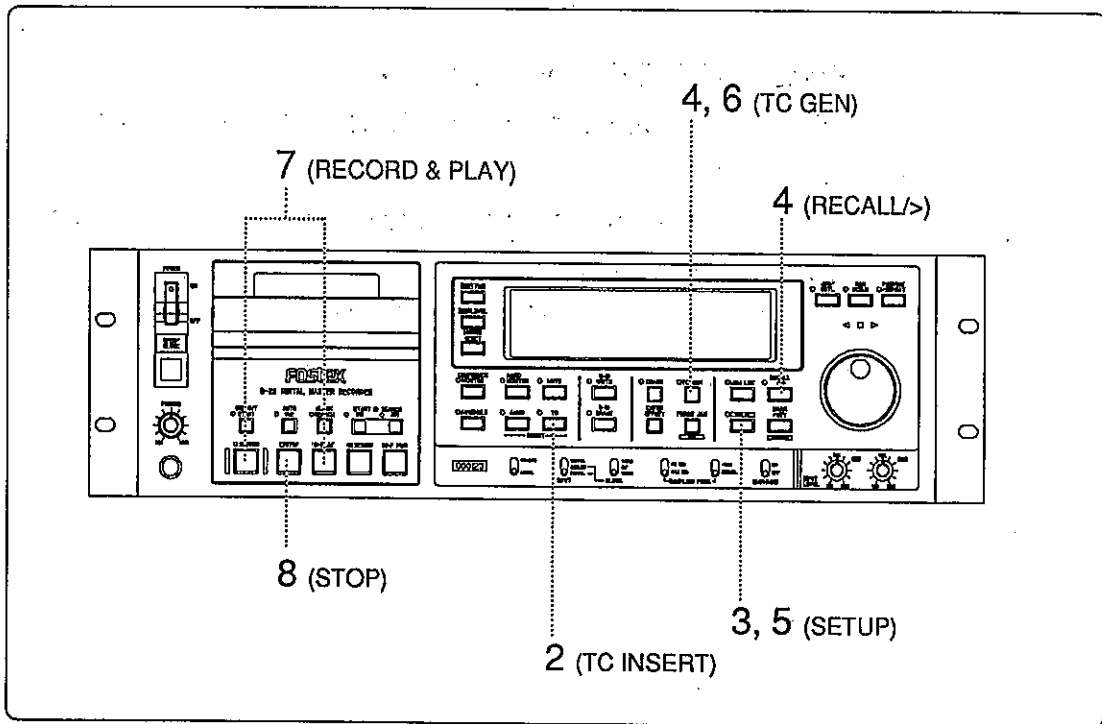

Operating Procedure

1. Place the sound recorded tape in the cassette tray and rewind it to the beginning.
2. Turn the TC INSERT key on to set only the time code track to the insert mode.
3. Switch the RUN MODE of the INT generator to "FREE RUN" position. Select "410- 000" (FREE RUN) in SETUP mode "410- ***".

* Refer to chapter 9 SETUP MODE, for details of the SETUP mode.

4. Preset GENERATOR TIME to [00H:00M:00S:00F]. Edit GENERATOR TIME in the data edit mode.

* Refer to chapter 7 DATA EDIT MODE, for details of the SETUP mode.

5. Set the frame rate of the time code to be recorded. Select the desired frame rate in SETUP mode "402- ***".

* Refer to chapter 9 SETUP MODE, for details of the SETUP mode.

6. Turn the TC GEN key on to start the INT generator.

7. Hold the RECORD button and press the PLAY button to start sound recording.

<NOTE>

Try to avoid breaking up recorded timecode.

If time code recording is halted halfway and continuous time code recording is desired starting from the middle of the tape, refer to the next paragraph 6-1-3.

8. After completion of time code recording, press the STOP button to stop tape.

At the same time, press the TC GEN key to turn off the internal time code generator.

6-1-3. Recording of Continuous Time Code Starting Halfway

Continuous time code recording can start in the insert mode from previous time code recording that was stopped halfway.

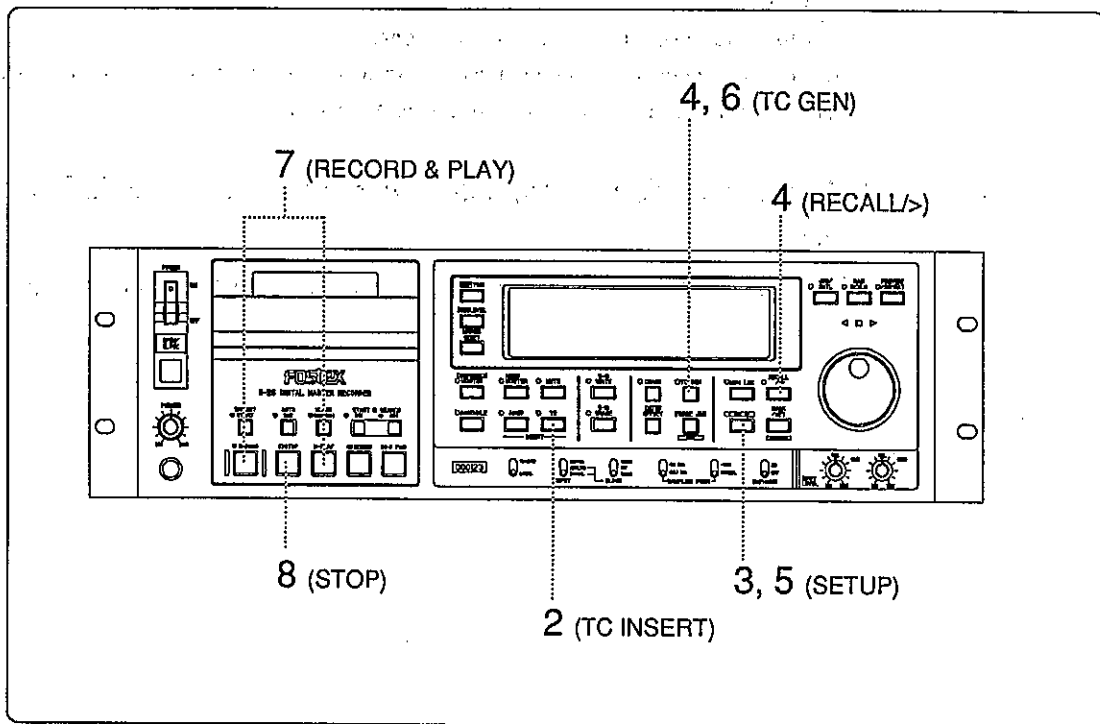

Operating Procedure

1. Locate the end of the time code recorded portion. Rewind the tape a little past the end.
 2. Turn "ON" the TC INSERT key alone to set only the time code track to the insert mode.
 3. Switch RUN MODE of the INT generator to "REC RUN".
Set "410-001" (REC RUN) in SETUP mode "410-***".
- * Refer to chapter 9 SETUP MODE, for details of the SETUP mode.
4. Set the frame rate of the time code to be recorded to that recorded on the tape.
Select the desired frame rate in SETUP mode "402-***".
- * Refer to Chapter 9 SETUP MODE, for details on the SETUP mode.
5. Turn the TC GEN key on.
 6. Hold the RECORD button and press the PLAY button to start sound recording.
The internal generator will be jammed into the tape recorded time code and record continuing time code.
 7. After sound recording is completed, press the STOP button to stop tape.

6-2. Recording of Externally Supplied Time Code

This procedure is for recording time code alone or together with audio signals, in synchronization with the time code supplied from an external time code generator connected to the D-25 or one recorded on VCR.

6-2-1. Connections

To record external time code, external TC generators or the VCR must be connected as depicted below:

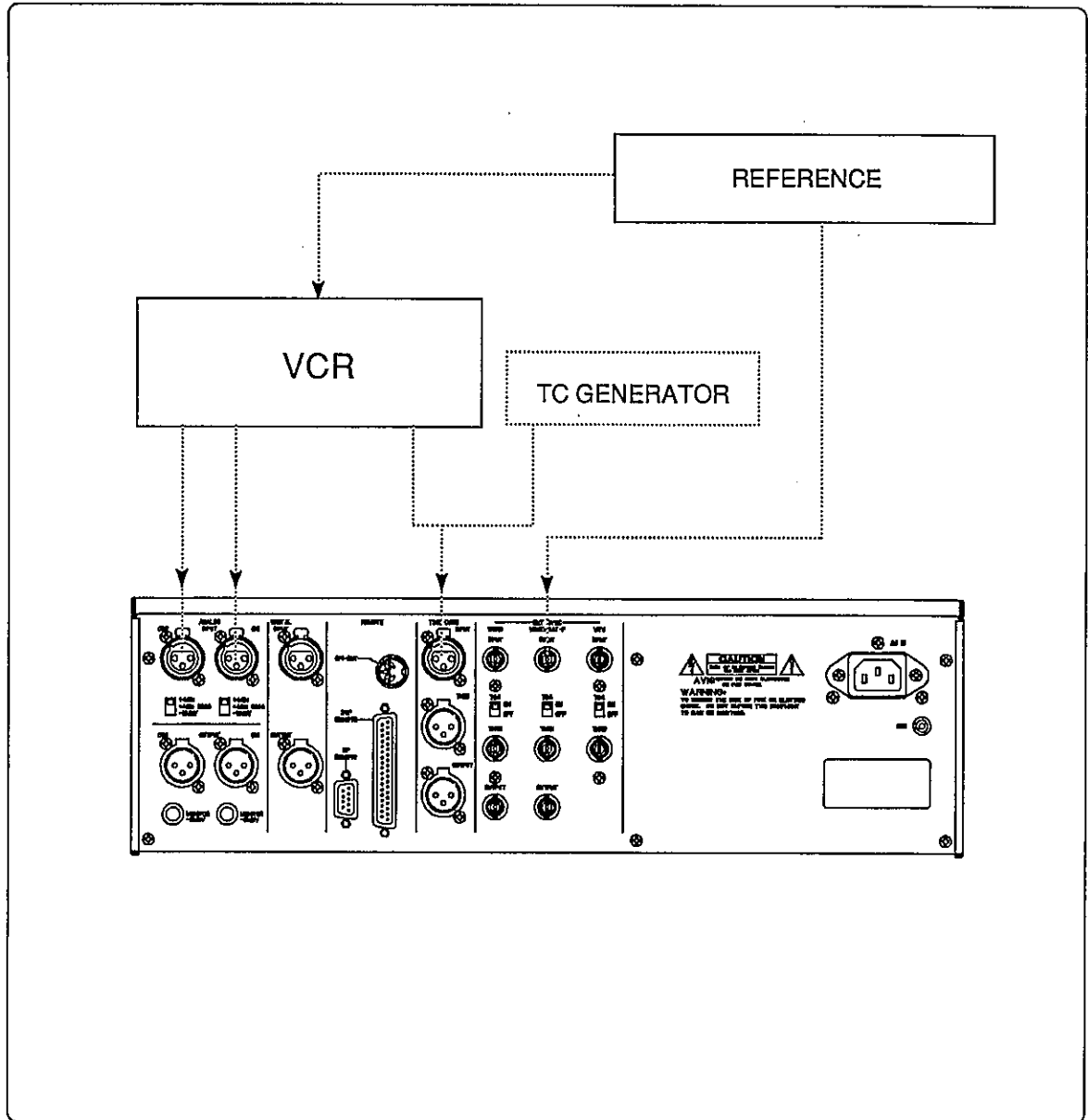

6-2-2. Time Code Recording Operation

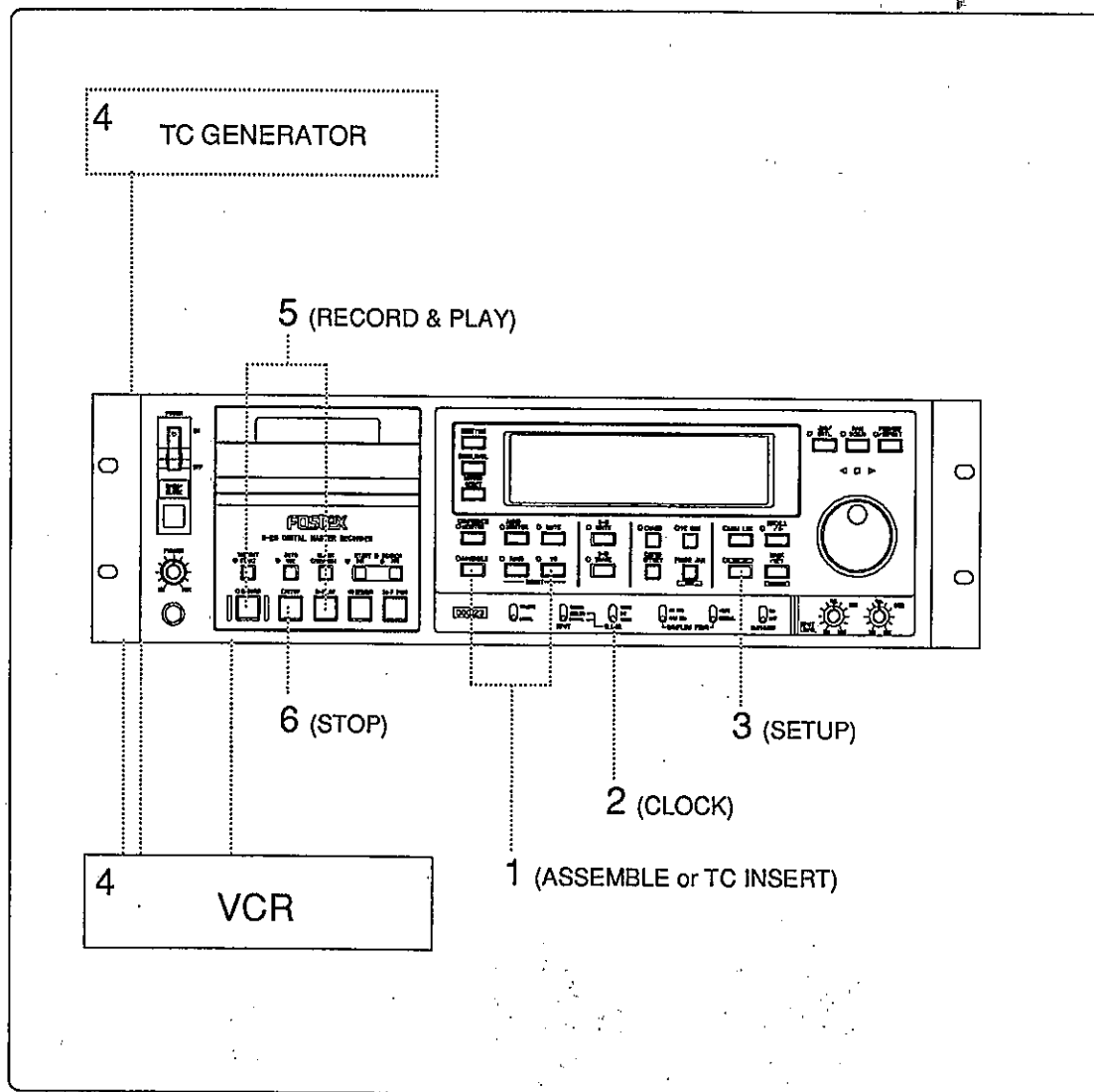

Operating Procedure

1. Select the sound recording mode.
Turn on the ASSEMBLE key for assemble recording, or the INSERT key alone for insert recording.
 2. Set the CLOCK switch to the "VIDEO" position when VIDEO REFERENCE input is available.
 3. Set the frame rate in agreement with the time code input.
Select the desired frame rate in SETUP mode "402- ***".
- * Refer to chapter 9 SETUP MODE, for details of the SETUP mode.
4. Start the external TC generator or VCR.
 5. Hold the RECORD button and press the PLAY button to start sound recording.
 6. After completion of recording, press the STOP button to stop the tape.

Chapter 7

Data Edit Mode

Given here are details of the data edit mode available with this machine.

In the data edit mode, editing of memory locate data, GENERATOR TIME data of the internal generator and CHASE OFFSET data editing, and input of NEXT P-NO can be performed.

Chapter 7 Table of Contents

7-1. Data Edit Mode Operation.....	7-1
7-1-1. Editing of Memory Locate Time data (RECALL/> → MEM LOC).....	7-2
7-1-2. Editing of GENERATE TIME Supplied by the INT Generator (RECALL/> → TC GEN).....	7-4
7-1-3. CHASE OFFSET Edit (RECALL/> → CHASE).....	7-6
7-1-4. NEXT P-NO Input (RECALL/> → S-ID WRITE).....	7-8

7-1. Data Edit Mode Operation

To enter the data edit mode, turn on the RECALL/> key. Then, press the appropriate keys in the following menu.

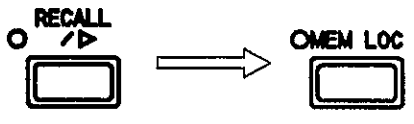
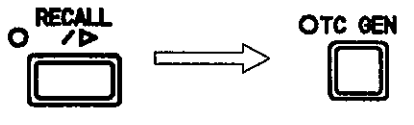
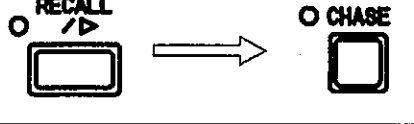
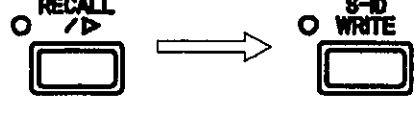
	To edit memory locate time data.
	To edit GENERATE TIME of the internal generator.
	To edit CHASE OFFSET data required for chased synchronization.
	To enter NEXT P-NO required for S-ID recording.

Edited data can be registered as new data when the MARK/SET key is pressed.

7-1-1.Editing of Memory Locate Time Data (RECALL/>→MEM LOC)

This machine is capable of memorizing any time point of A-TIME or time code recorded on the tape. The D-25 can memorize only one piece of time data at a time.

In the data edit mode, memory locating can be done after input of new time data into the memory or with time data previously in memory, and after input of the desired location time.

<NOTE>

This mode can be entered at any time except when in SETUP mode.

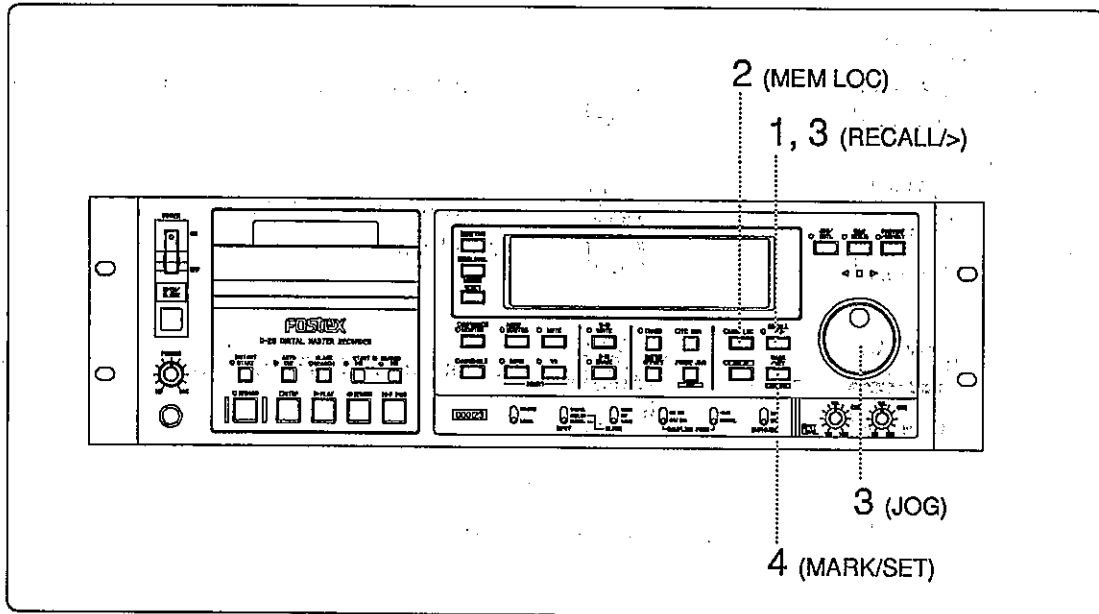

Operating Procedure

1. Turn the RECALL/> key on.
The RECALL/> key LED will light.
2. Press the MEM LOC key.
The RECALL/> key LED will go off.
The display will show currently stored time data, which can now be edited.

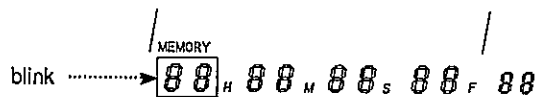

A-TIME data or TC data will be displayed if that is the data in the memory. If the memory is empty, [00H:00M:00S:00F] will appear on the display.

* To confirm time data or quit work, press the QUIT or DISP TIME key after Step 2. You can exit from the data edit mode.

3. Enter the desired time data.
The entry will be accepted at the blinking edit point. To shift the edit point, press the RECALL/> key. Entry of numbers can be made with the JOG dial at the blinking point.

Clockwise	The figure will increase, and time will be counted up.
Counter-clockwise	The figure will decrease, and time will be counted down.

4. After entry of new time data, press the MARK/SET key.

At the same time as registration of the input data as memory locate data, the data edit mode will be released. The screen will return to the display prior to entry to the edit mode.

- * If the MEM LOC key is pressed without pressing the MARK/SET key after Step 3 above, a locating action to the new time data will commence, with data registration held as pending.

7-1-2. Editing of GENERATE TIME Supplied by the INT Generator (RECALL/> → TC GEN)

This machine is equipped with an internal time generator. Time code generated by it can be recorded internally or externally output.

Using the procedure described here, GENERATE TIME from the internal generator can be edited for so that the GENERATOR will start from the desired time.

<NOTE>

This mode can be entered at any time except when in the SETUP mode.

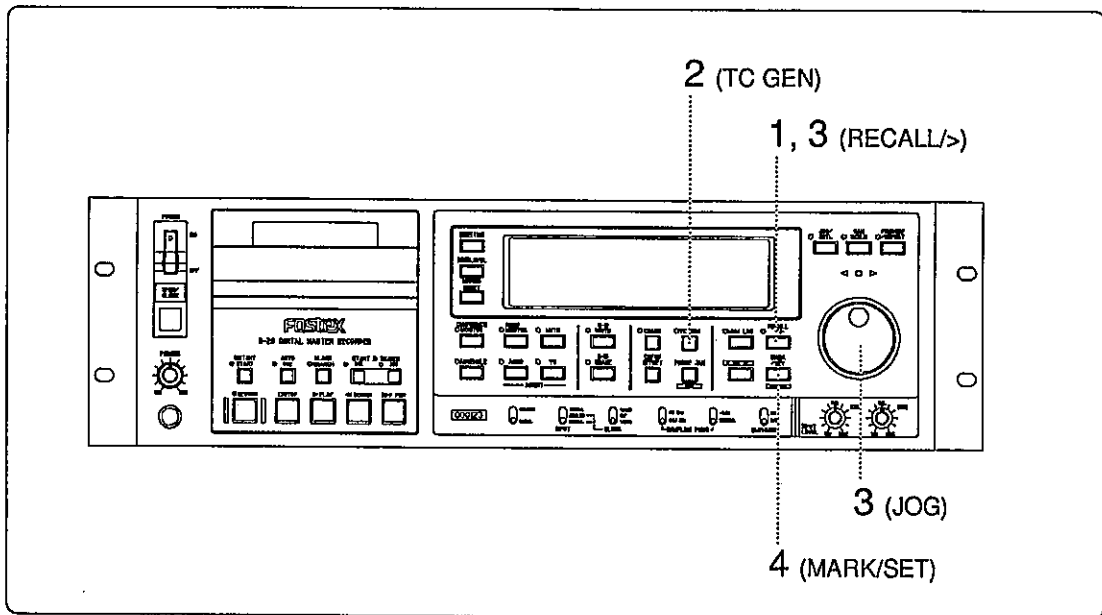

Operating Procedure

1. Turn the RECALL/> key on.
RECALL/> key LED will light.
2. Press the TC GEN key.
RECALL/> key LED will go off.
With the appearance of time data of the internal generator in the display, time data editing is possible.

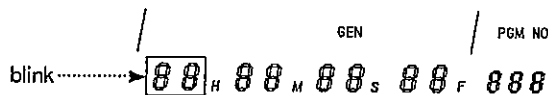

* To confirm time data or quit work, press the QUIT or DISP TIME key after Step 2. You can exit from the data edit mode.

3. Enter the desired time data.
Entry will be accepted at the blinking edit point. To shift the edit point, press the RECALL/> key.
Entry of numbers can be made manipulating the JOG dial at the blinking point.

Clockwise	The figure will increase, and time will be counted up.
Counter-clockwise	The figure will decrease, and time will be counted down.

4. After entry of new time data, press the MARK/SET key.

With the registration of the data entered as the starting time of the internal generator, the data edit mode will release. The screen will return to the display prior to entry to the edit mode.

7-1-3. CHASE OFFSET edit (RECALL/> → CHASE)

Press the CATCH OFFSET key to set the OFFSET value of the time code to be input and that on tape as CHASE OFFSET.

This procedure makes it possible to edit CHASE OFFSET to any value in order to run this machine in synchronization to external equipment.

"Offset editing" is the fixed time difference (CHASE OFFSET TIME) between two time codes functioning in synchronization to each other, and this can be set.

Using this setting, a slave machine will start chase action in synchronization to external time code and retain an interval of a length equal to the CHASE OFFSET time.

<NOTE>

This mode can be entered at any time except when in the SETUP mode.

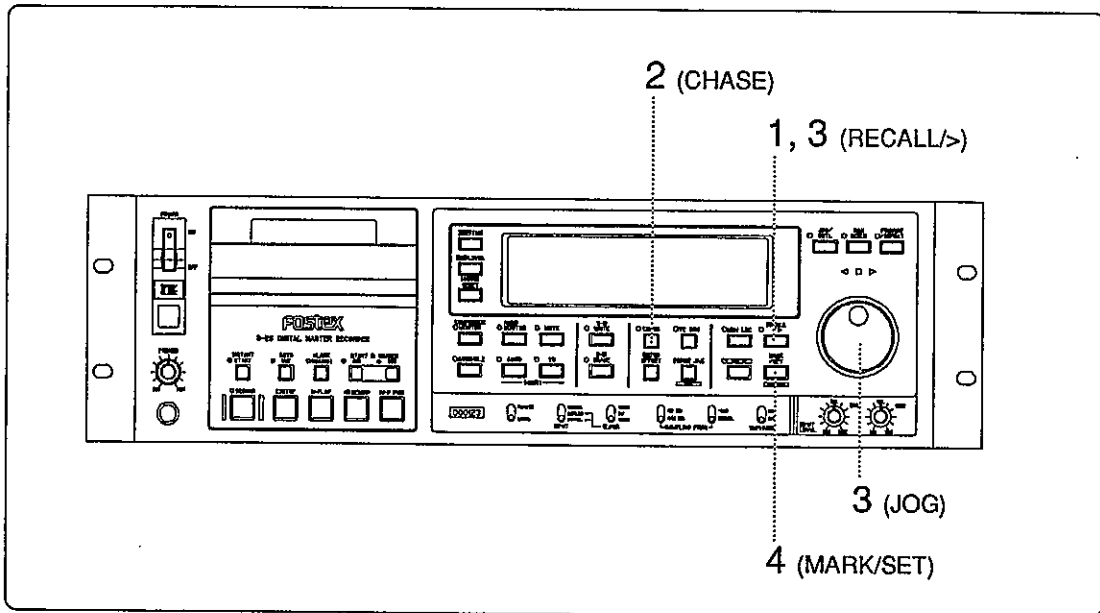

Operating Procedure

1. Turn the RECALL key on.
The RECALL/> key LED will light.
2. Press the CHASE key.
The RECALL/> key LED will go off.
The display will change to the CHASE OFFSET edit mode.

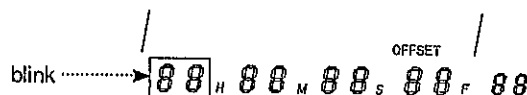

* To confirm time data or quit work, press the QUIT or DISP TIME key after Step 2. You can exit from the data edit mode.

3. Enter the desired time data.

Entry can be accepted at the blinking edit point. To shift the edit point, press the RECALL/> key. Numbers can be entered with the JOG dial at the blinking point.

Clockwise	The figure will increase, and time will be counted up.
Counter-clockwise	The figure will decrease, and time will be counted down.

4. After entry of new time data, press the MARK/SET key.

The data just entered will be established as the CHASE OFFSET value. The data edit mode will be released, and the display will return to the screen appearing prior to the edit mode.

Functions available will be either one of the followings depending upon the setting of CHASE OFFSET:

- * A slave machine will synchronize ahead of the time code of the master machine by as much as the CHASE OFFSET value if CHASE OFFSET is set to (+) time.
- * A slave machine will synchronize behind the time code of the master machine by as much as the CHASE OFFSET value if CHASE OFFSET is set to (-) time.
- * A slave machine will catch up with the master machine and synchronize to the same time as time code if CHASE OFFSET is set to (00:00:00:00) time.

7-1-4. NEXT P-NO Input (RECALL/> → S-ID WRITE)

NEXT P-NO can be entered for entry of an S-ID.

<NOTES>

- * This mode can be entered any time except when in the SETUP mode.
- * Pressing the RECALL/> key will not enter this mode if the erase protect hole of the tape cassettes is open.

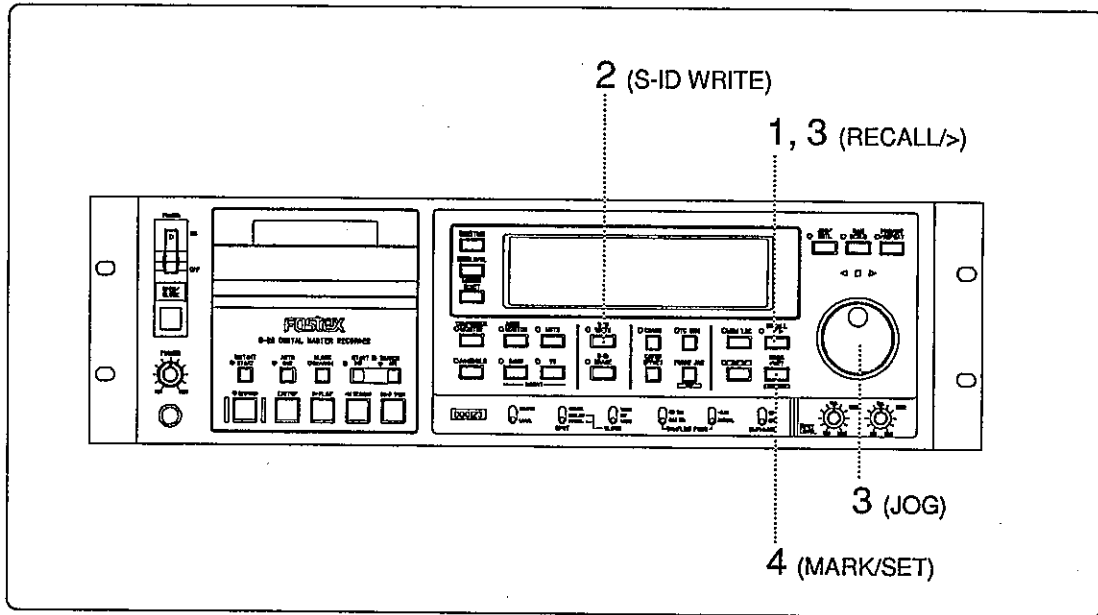

Operating Procedure

1. Turn the RECALL/> key "ON".
The RECALL/> key LED will light.
2. Press successively the S-ID WRITE key.
The RECALL/> key LED will go off.
The [NEXT] segment of the display will blink, and NEXT P-NO can be entered.

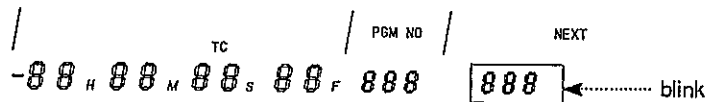

- * To quit operation, press the QUIT or DISP TIME key. You can exit from the data edit mode.

3. Enter the desired P-NO
Numbers can be entered with the JOG dial.
A clockwise turn of the dial will increase the figure, and a counter-clockwise turn will decrease the figure. A range of figures from 001 through 799 can be entered.
4. After entry of NEXT P-NO, press the MARK/SET key.
The edit mode will be released when the MARK/SET key is pressed.
5. Press the S-ID WRITE key.
A P-NO entered on NEXT P-NO will be recorded along with an S-ID at the point of pressing.

Chapter 8

Applications

Various applications of the D-25 are explained here.

Because of its editing capacity, our D-25 can be used best when it is synchronized to other equipment (chase sync function), or connected to a Fostex D-30 which plays as a recording and the D-25 as an editing machine with a player function.

Chapter 8 Table of Contents

8-1. Chase Synchronization Function.....	8-1
8-1-1. Connections.....	8-1
8-1-2. Operation.....	8-2
8-2. Audio Editing with the D-25 Connected to the D-30.....	8-3
8-2-1. Connections.....	8-3
8-2-2. Operation.....	8-4
8-3. Control with an Editor.....	8-5
8-3-1. Connections.....	8-5
8-3-2. Operation.....	8-6

8-1. Chase Synchronization Function

Chase Sync makes it possible for the D-25 to play back tape in synchronization with the time code being input from an external source provided the time code from the external source is supplied to the D-25 TIME CODE IN connector and the CHASE mode of the D-25 is turned on (turning the CHASE key on).

8-1-1. Connections

An example of the D-25 as slave and a VCR as master machine is shown below. In this instance, audio signals are played back by having the D-25 chase the time code input to the D-25 from the VCR.

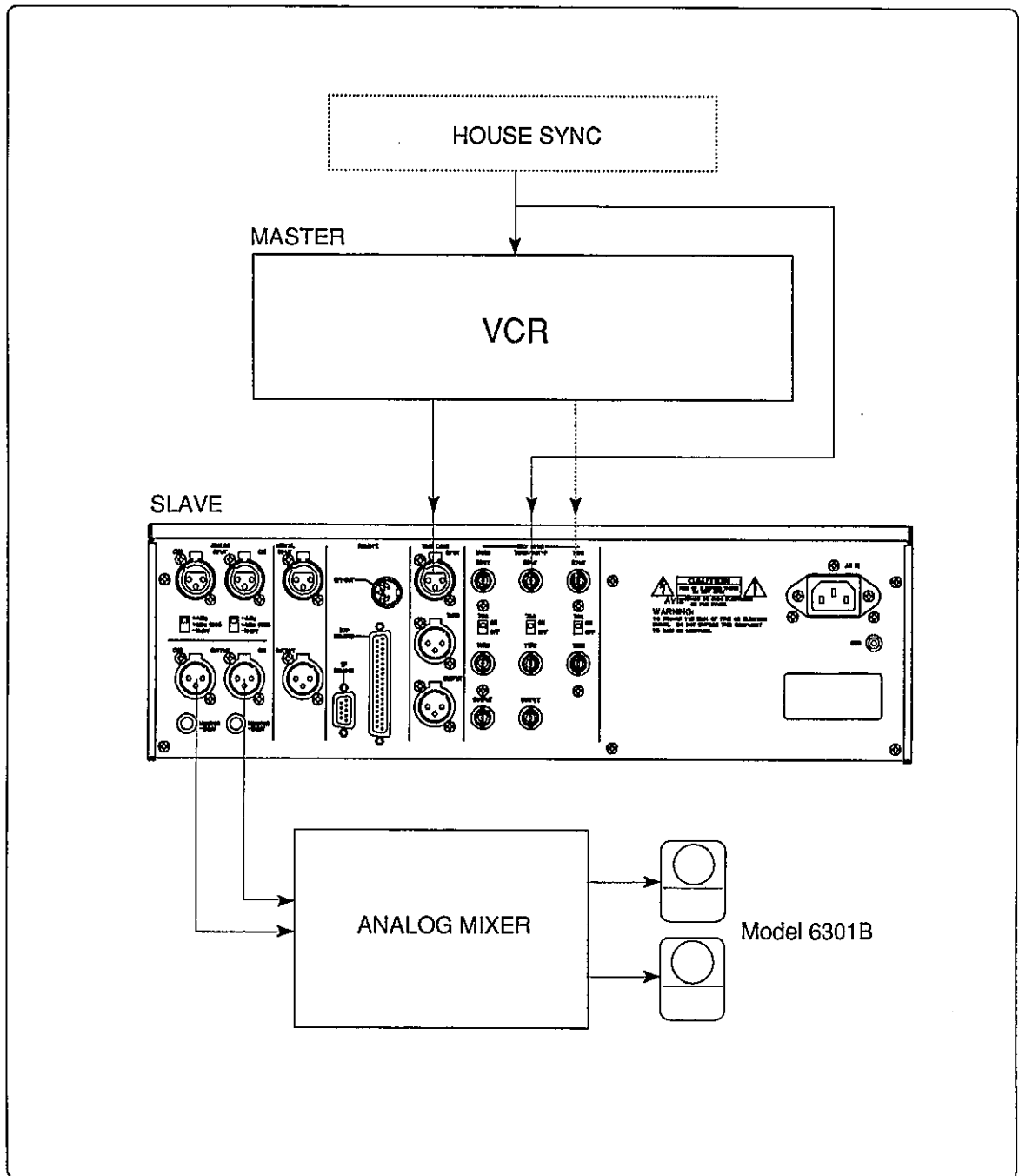

8-1-2. Operation

Setting Before Operation

Before execution of CHASE, make the appropriate settings as follows:

1. Set up the CHASE mode.

Select a CHASE mode from [1 time], [Continue] and [F-Sync] in SETUP mode "501- ***".

* Refer to chapter 9, SETUP MODE, for setting SETUP mode "501- ***" (CHASE mode).

2. Set the LOCK WINDOW.

In SETUP mode "502- ***", set the reference frame which determines unlocking after CHASE LOCK.

* Refer to chapter 9, SETUP MODE, for setting SETUP mode "502- ***" (LOCK WINDOW).

3. Set the CHASE OFFSET value.

Normally, pressing the CATCH OFFSET key sets the offset value between REFTC and REP TC as the chase offset value.

The D-25 will maintain the chasing function time interval (CHASE OFFSET) value of your choice.

The CHASE OFF value can be optionally set in the data edit mode by turning on RECALL/ > key followed by pressing the CHASE key to turn it on.

* Refer to chapter 7, DATA EDIT MODE, for CHASE OFFSET setting.

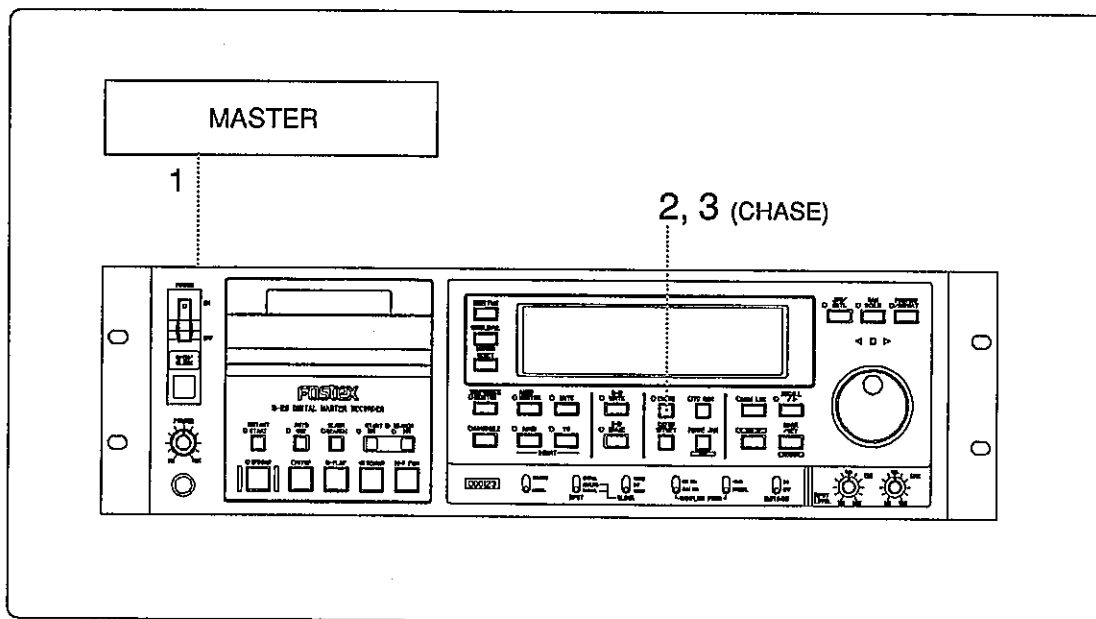

Operating Procedure

1. Start playback on the master machine (VCR).
2. Press the CHASE key to turn the CHASE mode on.
 The CHASE key LED will start blinking.
 Playback will commence with the playback time code of the D-25 as a slave chase-locking to the time code from the master machine.
 When chase-locked, the [CHASE LOCK] segment of the display and the CHASE LOCK key LED will light.
3. To stop the chase action, press the CHASE key again to the CHASE mode will turn off. (The CHASE key LED will go off.)

8-2. Audio Editing With the D-25 Connected to the D-30

Please use the information below when making an audio editing system using the D-30 as the "RECORDER" and the D-25 as the "PLAYER", connected through the RS422 (D-sub 9 pin).

<NOTE>

Refer to the D-30 Owner's Manual for operation of the D-30 here as a RECORDER.

8-2-1. Connections

1. Connect the D-30 RS-422B connector to the D-25 9 pin REMOTE connector.
2. Connect the D-25 DIGITAL OUT connector to the D-30 DIGITAL IN connector.
3. Connect the D-25 TIME CODE OUT connector to the D-30 TIME CODE IN connector.

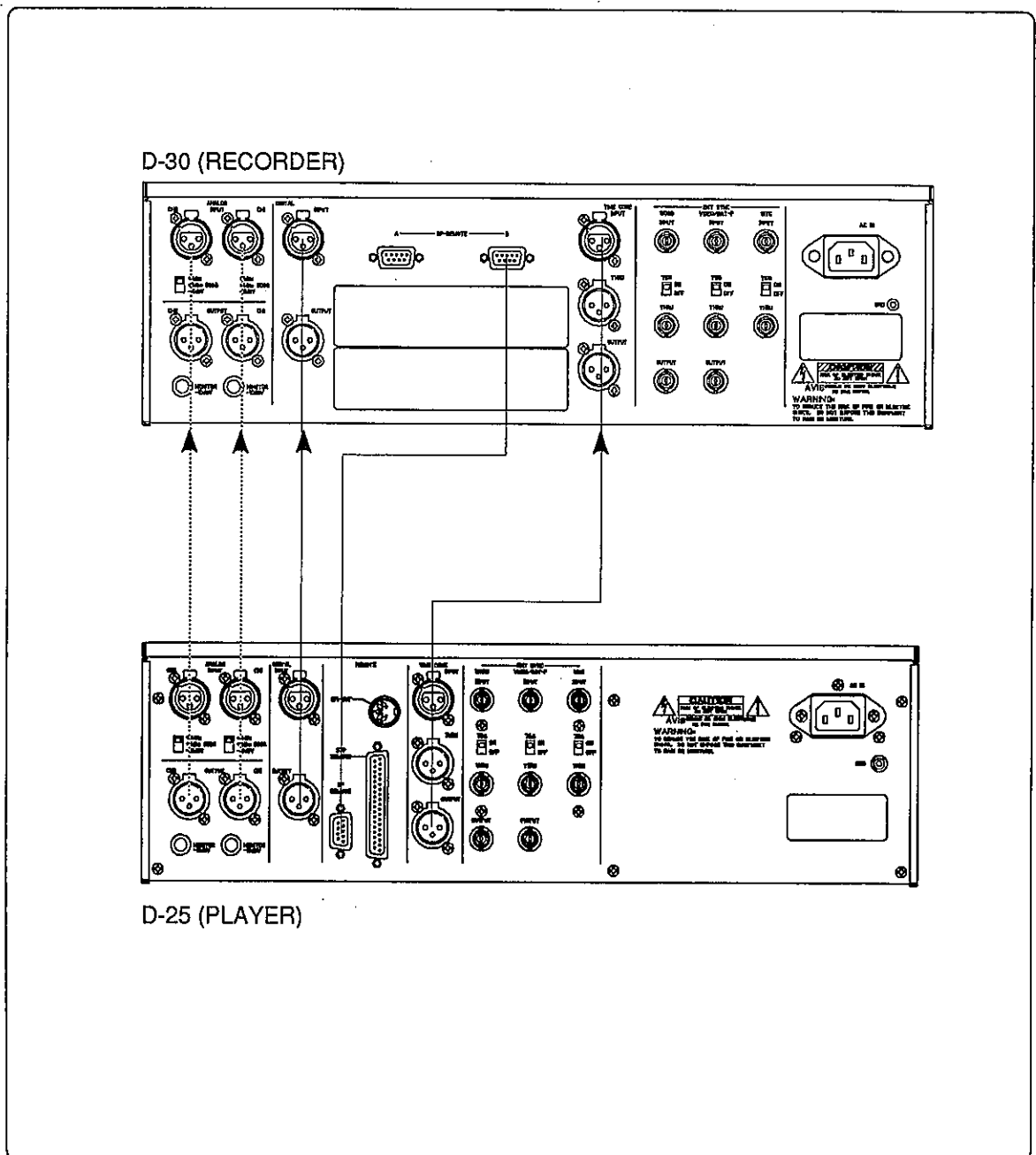

8-2-2. Operation

Setting Before Start of Operation

1. Load recording tape in the D-30 (RECORDER) and recorded tape in the D-25 (PLAYER).
2. Turn the REMOTE switch of the D-25 (PLAYER) to the "REMOTE" position.

* Please refer to the D-30 manual for operating procedures of the D-30 recorder.

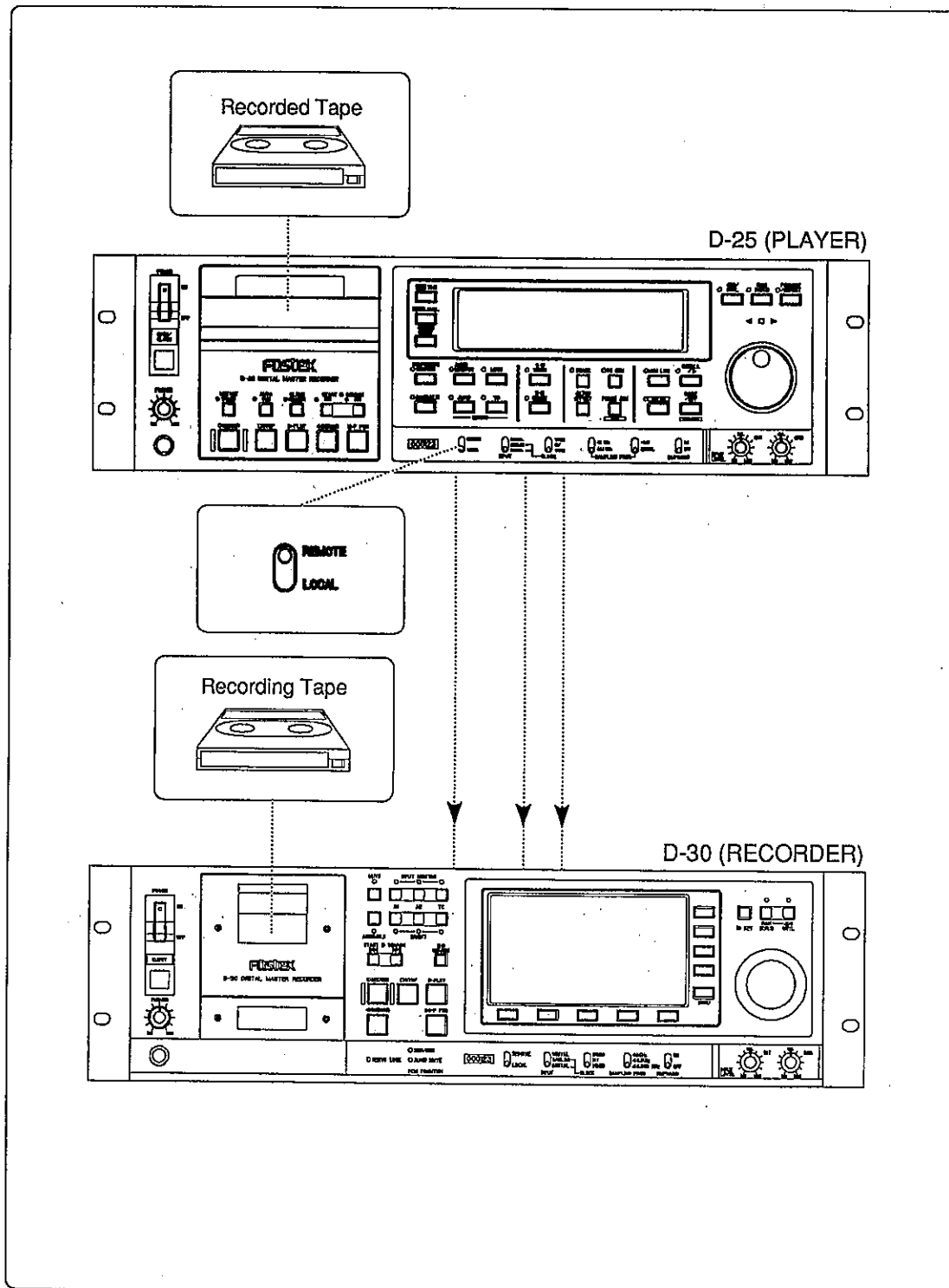

8-3. Control With an Editor

The D-25 can be controlled with an external editor connected to the D-25 9PIN REMOTE connector of the D-25. The following items can be controlled from an external editor connected with a 9PIN REMOTE.

Editing of SKIP-ID and END-ID.

Direct locating to P-No. or S-ID

Recording on the left channel or right channel of audio signals independently

Vari-speed is variable up to $\pm 12.5\%$ (0.1% step)

Various setting options are available to suit the editor for the best operation of the D-25. Setting options available for now include those for the SONY PCM-7050, SONY BVE series, CMX and LYNX. Selection can be completed through the use of SETUP mode "308-****".

* Refer to chapter 9 SETUP MODE, for details of the SETUP mode.

8-3-1. Connections

In the example here, two editor controlled D-25s are used with one as a RECORDER and the other as a PLAYER. The editor and the D-25s should be connected as illustrated below.

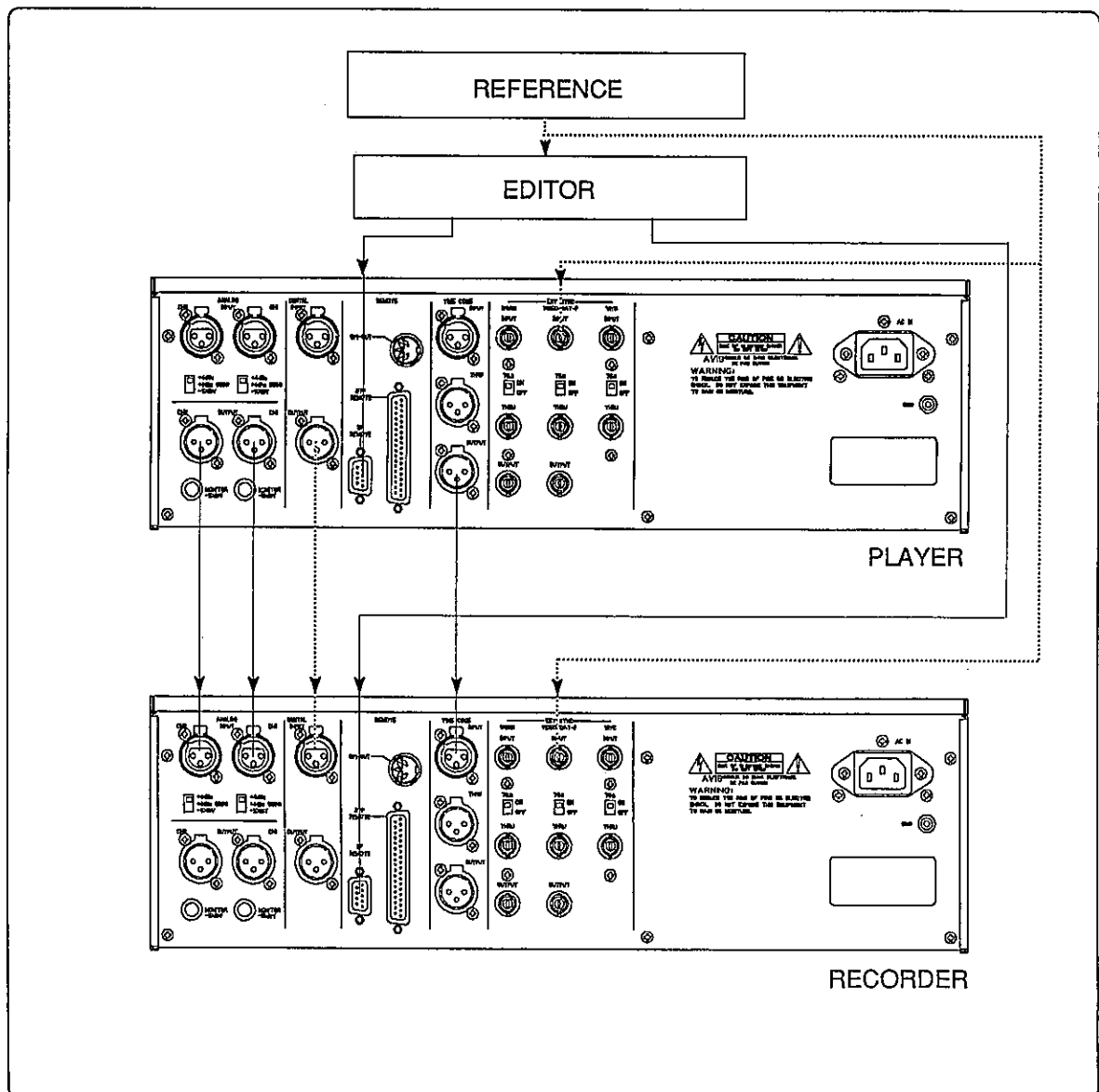

8-3-2. Operation

Setting Before Start of Operation

1. Press the SETUP key of both D-25s to set the SETUP mode to match the editor.
* Refer to Chapter 9 SETUP MODE, for details of the SETUP mode.
2. After setting the SETUP mode, press the QUIT or DISP TIME key to return to the normal display.
3. Set the REMOTE switch of both the D-25s to the "REMOTE" position.
Both the D-25s will be panel-locked and become editor controlled.
* Refer to the owner's manual of the editor for editor operation.

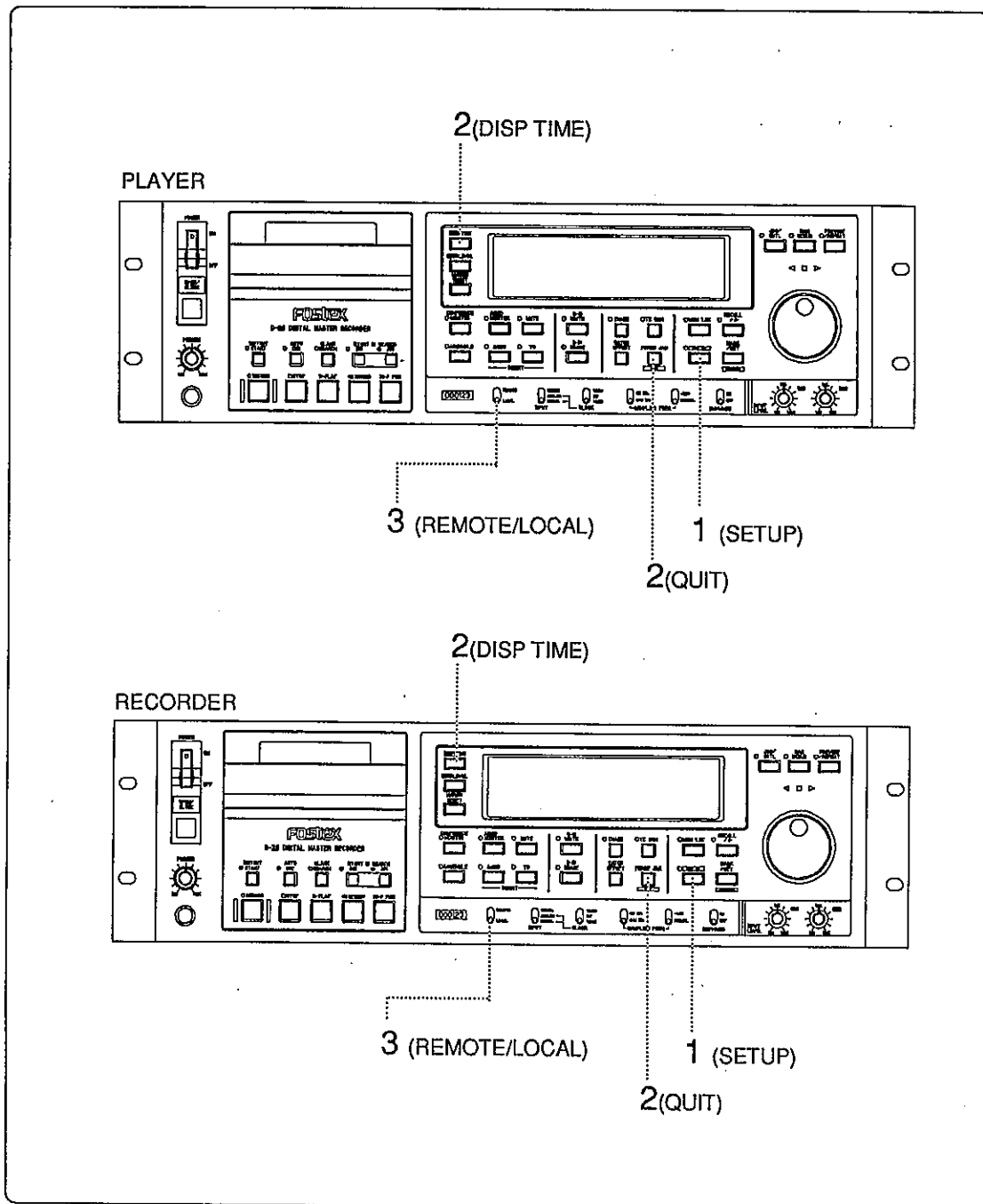

Chapter 9

Setup Mode

This chapter describes the SETUP modes available on the D-25.
Use the SETUP mode to confirm already established settings or for changing settings.

Chapter 9 Table of Contents

9-1. SETUP Mode.....	9-1
9-2. Display.....	9-2
9-3. Execution of Each Menu.....	9-4
9-4. Details of the SETUP Menus.....	9-5
Confirmation of the ROM version.....	9-5
Setting of the REFERENCE LEVEL.....	9-5
Setting of PAUSE OFF TIME.....	9-5
Setting of the DIGITAL OUT format.....	9-6
Setting of ON/OFF of the AUTO ID mode.....	9-6
Setting of the AUTO AUDIO EE mode.....	9-6
Setting of the AUTO TC EE mode.....	9-6
Setting of PANEL LOCK for remote controlling.....	9-7
Setting of the AUTO CUE/AUTO ID detection level.....	9-7
Setting of the AUTO CUE/AUTO ID detection time.....	9-7
Setting of ON/OFF of cuing action in response to SHUTTLE command.....	9-8
Setting of VCR emulation.....	9-8
Setting of the playback time code.....	9-9
Setting of the TC frame rate.....	9-9
Setting of ON/OFF of TC output during PAUSE.....	9-10
Setting on or off of time code output during FAST FORWARD.....	9-10
Setting on or off of time code output during REWIND.....	9-10
Setting of time code to be output.....	9-11
Setting of frame pulse output.....	9-11
Setting of the INT generator function mode.....	9-11
Setting of the CHASE function mode.....	9-12
Setting of LOCK WINDOW.....	9-12
Execution of the renumbering function.....	9-12
Execution of user memory ALL RESET.....	9-13

9-1. SETUP Mode

The following items can be confirmed or set in this SETUP mode:

1. Confirmation of the ROM version
2. Setting of the reference level
3. Setting of PAUSE OFF TIME
4. Setting of the DIGITAL OUT format
5. Setting of ON/OFF of the AUTO ID mode
6. Setting of the AUTO AUDIO EE mode
7. Setting of the AUTO TC EE mode
8. Setting of panel lock for remote controlling
9. Setting of the AUTO CUE/AUTO ID detection level
10. Setting of the AUTO CUE/AUTO ID detection time
11. Setting of ON/OFF of cuing action in response to SHUTTLE command
12. Setting of VCR emulation
13. Setting of the playback time code
14. Setting of the TC frame rate
15. Setting of ON/OFF of TC output during PAUSE
16. Setting of ON/OFF of TC output during F FWD
17. Setting of ON/OFF of TC output during REWIND
18. Setting of TC to be output
19. Setting of the frame pulse output
20. Setting of the INT generator function mode
21. Setting of the CHASE function mode
22. Setting of LOCK WINDOW
23. Execution of the renumbering function
24. Execution of user memory ALL RESET

9-2. Display

Press the SETUP key to enter the SETUP mode.

After entering into the SETUP mode, either one of the above menus will appear on the display.

The screen shown when the power was turned off will appear.

The displays of setting menus may be categorized as follows. Displays will be alphanumeric and comprising 7 LED segments. (* Refer to the next chart for the alphanumeric representation.)

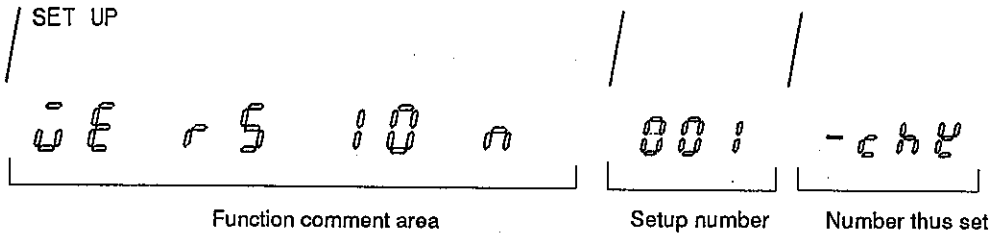

0	0	A	A	.	i	r	r
:	1	b	b	J	J	S	S
2	2	C	C	K	K	s	s
3	3	c	c	L	L	T	T
4	4	d	d	l	l	t	t
5	5	E	E	M	M	u	u
6	6	F	F	n	n	V	V
7	7	G	G	O	O	W	W
8	8	g	g	P	P	X	X
9	9	H	H	q	q	y	y

An initial menu can be selected by pressing the SETUP key or by manipulating the JOG dial. The selection can be made in the forward direction with the SETUP key, and in both forward and reverse directions with the JOG dial.

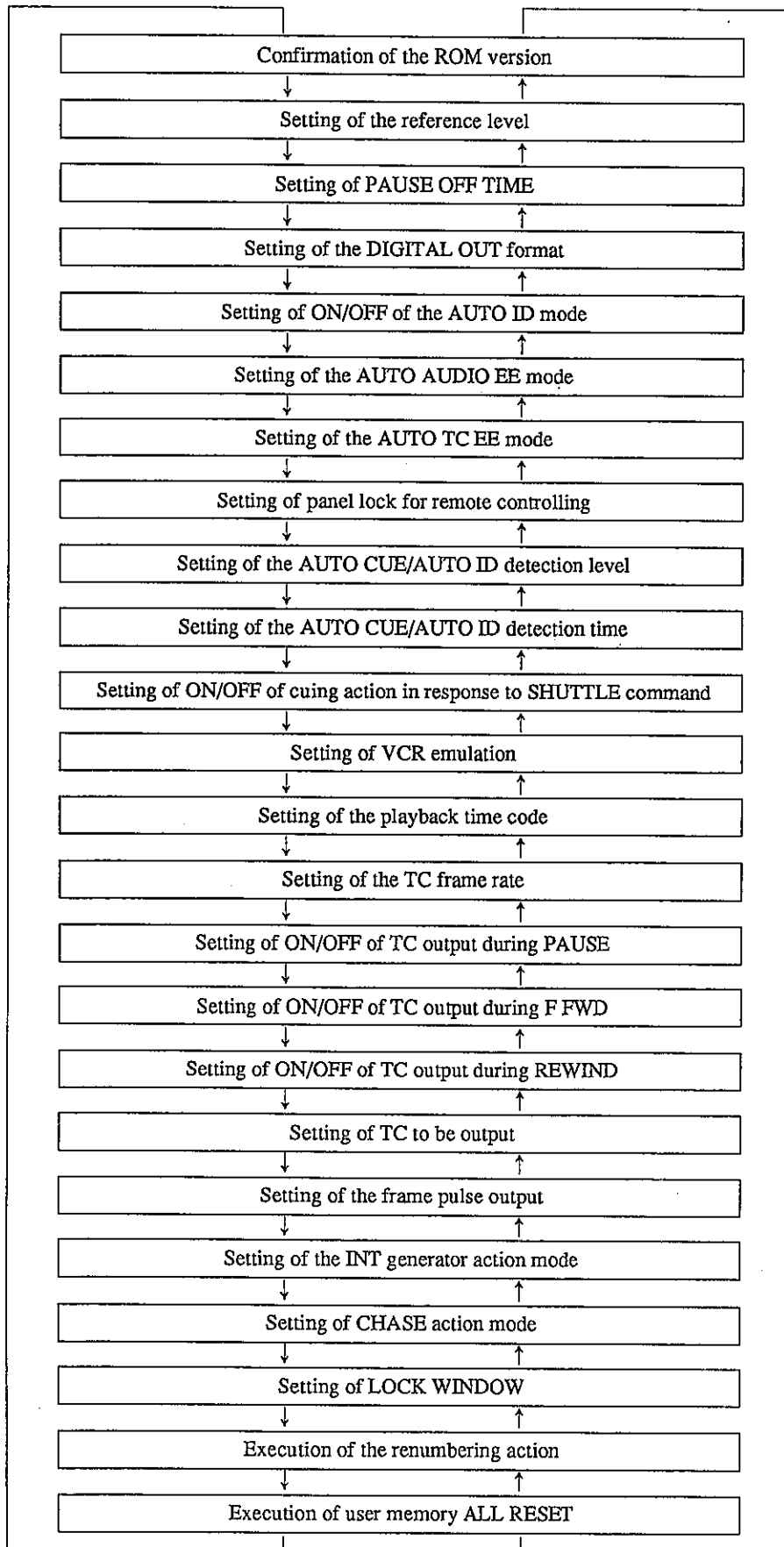

9-3. Execution of each menu

The operating procedure below must be followed for execution of each menu of the SETUP mode.

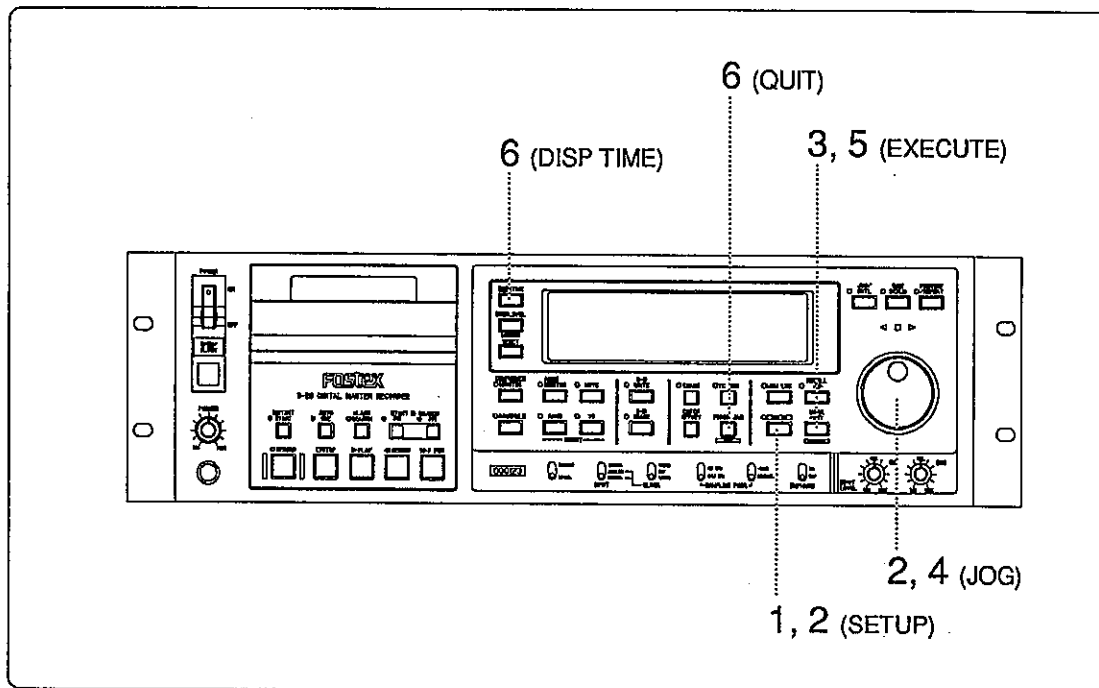

Operating Procedure

1. Press the SETUP key to enter the SETUP mode.
The menu present when the power was turned off will appear.
2. Select the desired initial menu by pressing of the SETUP key or by manipulating the JOG dial.
3. When the desired menu is reached, press the EXECUTE key.
Pressing the key will display the current setting condition with the selected "setting number" blinking.

<NOTES>

- SETUP "001- CHK", "002- CHK", "601- EXC" and "801- EXC" are excluded.
- The version will be displayed for "001- CHK" and "002- CHK".
- "EXC" will blink on each of "601- EXC" and "801- EXC" menus. A successive press of the EXECUTE key will put the menu in the ready-to-work condition.

A blinking number indicates that it can be changed. If no change is desired press the EXECUTE key, or, proceed with the following steps when changing. (To escape from the SETUP mode, press the QUIT key.)

4. Turn the JOG dial to select the desired setting number.
Change of the number will be accompanied by a corresponding item description display.
5. When the desired number is located, press the EXECUTE key.
The number light will change from blinking to solid, and the item will be registered.
6. After completion of registration, press the QUIT or DISP TIME key.
Escape from the SETUP mode will be made and the screen will change to the one shown prior to entry into the SETUP mode.
7. For setting corrections, repeat the above steps 2 through 5.

9-4. Details of the SETUP menus (Figures with (*) designate that they are default values.)

■ **Confirmation of the ROM version (SETUP "001- chK" and "002- chK")**

This menu tells the version numbers of MPU1 and MPU2 ROMs loaded in the D-25. The ROM version will be displayed in each initial menu by a press of the EXECUTE key. The initial menu will resume with another press of the key.

Confirmation of MPU1 ROM version

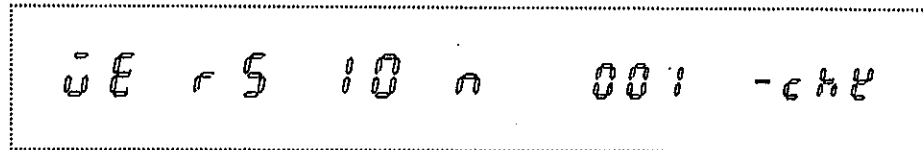

Confirmation of MPU2 ROM version

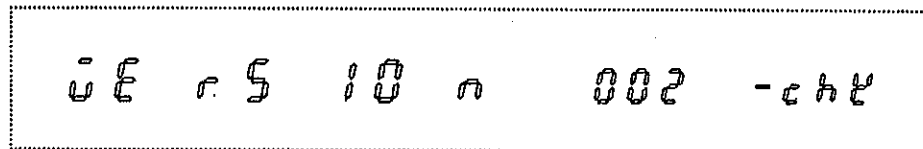

■ **Setting of the reference level (SETUP "102- ***")**

The reference level of the D-25 can be set in this menu. As the level is changed, the indication in the [REF] segment will change accordingly.

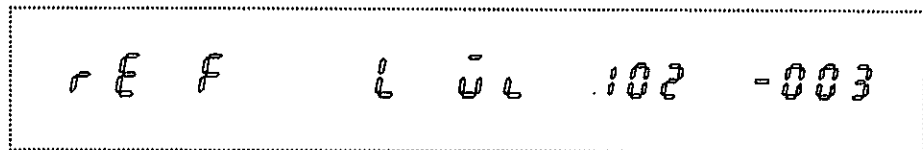

Setting numbers	Description
[001]	-20dB (The reference level will be set to -20dB.)
[002]	-18dB (The reference level will be set to -18dB.)
[003] (*)	-12dB (The reference level will be set to -12dB.)

<NOTE>

Following the reference level change, the headphone output level will also change.

■ **Setting of PAUSE OFF TIME (SETUP "104- ***")**

On the D-25, the pause mode will automatically release to protect the tape or for other purposes. This menu sets the time until execution of release.

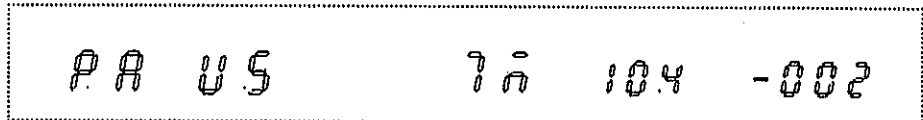

Setting number	Description
[000]	1 min (PAUSE will be released in 1 minute.)
[001]	2 min (PAUSE will be released in 2 minutes.)
[002] (*)	3 min (PAUSE will be released in 3 minutes.)
[003]	5 min (PAUSE will be released in 5 minutes.)
[004]	NON STOP (PAUSE will remain engaged.)

<NOTE>

Use of the [004], NON STOP mode, is strongly discouraged due to possible tape damage and increased error rate.

■ **Setting of the DIGITAL OUT format (SETUP "105- ****")**

This menu sets the digital interface format in conjunction with the DIGITAL OUT connector.

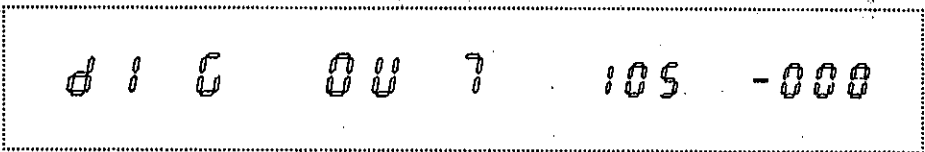

Setting number	Description
[000] (*)	AES EBU (AES/EBU (IEC 958 Broadcasting studio use) will be selected.)
[001]	CONSUMER (IEC 958 Consumer use will be selected.)

■ **Setting of ON/OFF of the AUTO ID mode (SETUP "106- ****")**

This menu sets ON/OFF of the AUTO ID mode for S-ID recording.

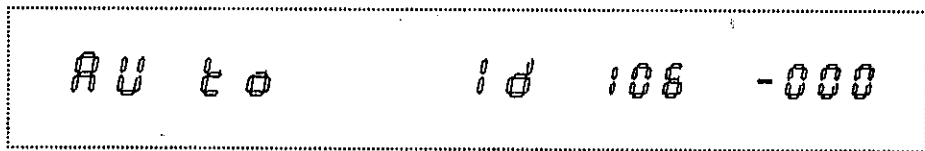

Setting number	Description
[000] (*)	OFF (AUTO ID mode will be turned OFF.)
[001]	ON (AUTO ID mode will be turned ON.)

<NOTE>
The detection level and time for use with AUTO ID ON can be set on "201- ****" and 202- ****.

■ **Setting of the AUTO AUDIO EE mode (SETUP "107- ****")**

This menu determines which to set the AUDIO EE mode to, AUTO or MANUAL.

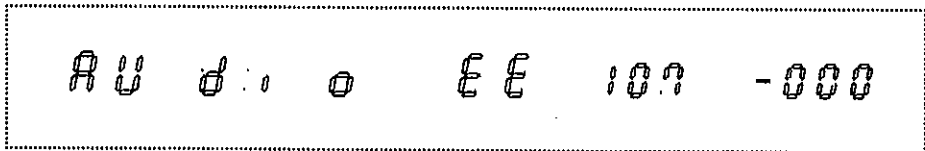

Setting number	Description
[000] (*)	MANUAL (AUDIO INPUT MONITOR will be manually operable.)
[001]	AUTO (AUDIO INPUT MONITOR will be automatically set when in the STOP or PAUSE mode.)

■ **Setting of the AUTO TC EE mode (SETUP "108- ****")**

This menu determines whether to set the time code EE mode to AUTO or MANUAL.

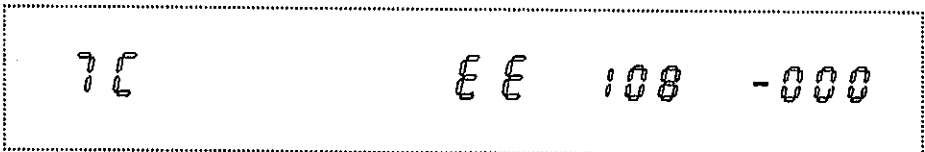

Setting number	Description
[000] (*)	MANUAL (TC INPUT MONITOR will be manually operable.)
[001]	AUTO (TC INPUT MONITOR will be automatically set when in STOP or PAUSE mode.)

■ **Setting of panel lock for remote controlling (SETUP "109- ***")**

This menu sets panel lock ON/OFF when the D-25 is used in the REMOTE mode.

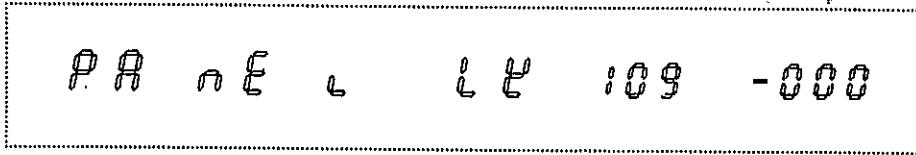

Setting number	Description
[000] (*)	OFF (Under the REMOTE mode, control is possible only externally. Controls on the front panel of this machine will be frozen.)
[001]	ON (Under the REMOTE mode, control is possible both externally and with buttons and keys on the front panel of the D-25.)

■ **Setting of the AUTO CUE/AUTO ID detection level (SETUP "201- ***")**

This menu sets the threshold sound level to determine the turning sound level from a no-sound section to a sound section.

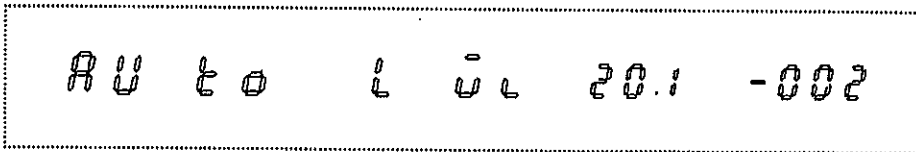

Setting number	Description
[000]	-20dB (Threshold level will be set at -20dB.)
[001]	-30dB (Threshold level will be set at -30dB.)
[002] (*)	-40dB (Threshold level will be set at -40dB.)
[003]	-55dB (Threshold level will be set at -55dB.)

■ **Setting of the AUTO CUE/AUTO ID detection time (SETUP "202- ****")**

This menu sets the length of no-sound time for execution of the AUTO CUE or AUTO ID mode.

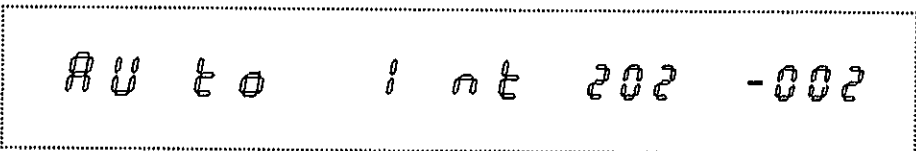

Setting number	Description
[000]	300ms (No-sound time will be set at 300m seconds.)
[001]	600ms (No-sound time will be set at 600m seconds.)
[002] (*)	900ms (No-sound time will be set at 900m seconds.)
[003]	1200ms (No-sound time will be set at 1200m seconds.)
[004]	1500ms (No-sound time will be set at 1500m seconds.)

■ **Setting of ON/OFF of cuing action in response to SHUTTLE command (SETUP "307- ****")**

This menu sets the cuing monitor function by means of JOG/SHTL with signals from RS-422.

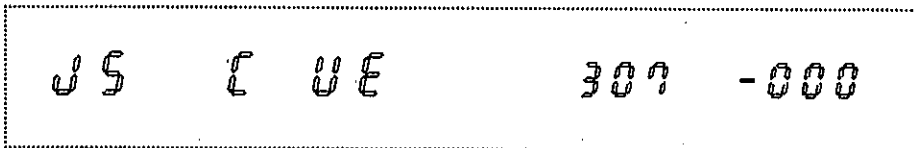

Setting number	Description
[000] (*)	OFF (Cuing monitor is possible only at 1X PLAY speed. Not at any other speeds.)
[001]	ON (Cuing monitor is possible at all speeds except F FWD/REWIND at a higher speed.)

■ **Setting of VCR emulation (SETUP "308- ****")**

This menu sets PRESET DATA so that the D-25 can operate under an optimum condition in accord with the connected editor.

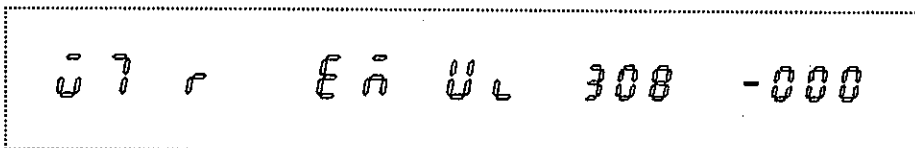

Setting number	Description
[000] (*)	NATIVE (Provided for NTSC standards)
[001]	PCM-7050 (Provided for SONY PCM-7050)
[002]	BVE1 (Provided for the latest BVE series)
[003]	BVE2 (Provided for BVE series of old versions)
[004]	CMX (Provided for CMX)
[005]	LYNX (Provided for LYNX synchronizer)

■ Setting of the playback time code (SETUP "401- ****")

This menu sets the playback time code format.

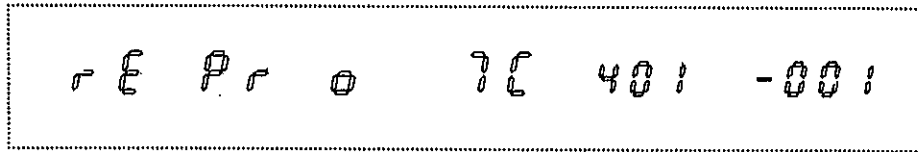

Setting number	Description
[001] (*)	IEC (AUTO) (IEC format is given precedence. FOSTEX format will be output when FOSTEX format is available and the IEC format is not. The conversion frame is AUTO in this occasion.)
[002]	FOSTEX (FOSTEX format will be given precedence. IEC format will be output when IEC format is available and FOSTEX format is not. The conversion frame is AUTO in this occasion.)
[003]	A-TIME (The TC conversion frame from A-TIME will be identical to that of the INT generator.)
[004]	IEC (MANUAL) (The IEC format conversion frame will be identical to that of the INT generator.)
[005]	NON (No TC will be output.)

<NOTES>

- * The FOSTEX format can only output LTC. Indication on the display and locate action will not be done.
- * We suggest the tape recorded with the FOSTEX format be converted to IEC format by digital-copying audio and time code.

■ Setting of the TC frame rate (SETUP "402- ****")

This menu sets TC TIME FRAME for the internal generator and synchronization to external video.



Setting number	Description
[000]	24 FRAME (American motion picture)
[001] (*)	25 FRAME (European film/PAL-SECAM video EBU)
[002]	29.97 DF (NTSC color with real time adjust)
[003]	29.97 NDF (NTSC color)
[004]	30 NDF (NTSC video/film)
[005]	30 DF (NTSC video/film)

■ **Setting of ON/OFF of TC output during PAUSE (SETUP "403- ****")**

This menu determines whether the same TC be output in the PAUSE mode. f

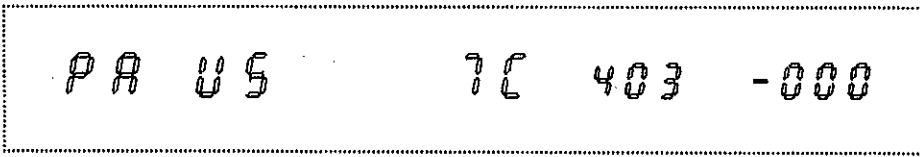

Setting number	Description
[000] (*)	OFF (No TC will be output on PAUSE.)
[001]	ON (Read out TC will be repeatedly output in a unit consisting of hour, minute, second and frame.)

■ **Setting on or off of time code output during fast forward (SETUP "404- ****")**

This menu sets the time code output system in fast forward and rewind modes.

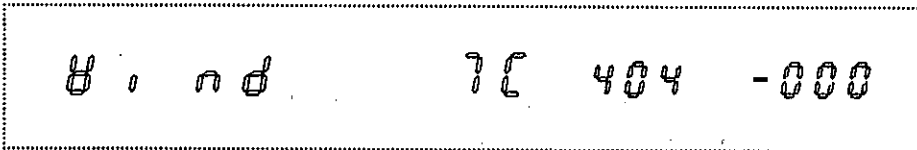

Setting number	Description
[000] (*)	1 FrAm (One unit of the read time code of hour, minute, second and frame will be output.)
[001]	5 FrAm (A total of 5 units, comprising one unit of the read time code of hour, minute, second and frame, with 4 units added in a quasi manner will be output after conversion into continuous time frames in the forward direction.)
[002]	StoP (No time code will be output except in the PLAY or STOP mode.)

■ **Setting on or off of time code output during REWIND (SETUP "407- ****")**

This menu sets the frame data format by the time code output in reverse running (REW mode).

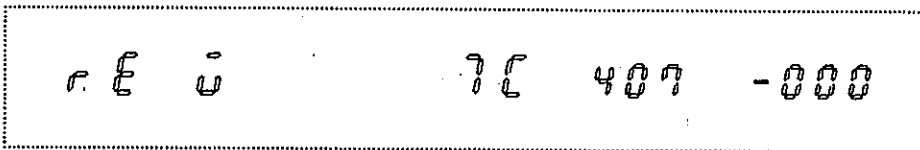

Setting number	Description
[000] (*)	FORWARD (TC output will be generated in the form of a bit train arranged in the forward direction, even when in the reverse mode. This mode is useful for time code readers which can read TC only in the forward direction such as FOSTEX model 4030.)
[001]	REVERSE (A TC bit train will be generated in the reverse direction in the reverse mode.)

■ **Setting of time code to be output (SETUP "408- ***)**

This menu sets the type of the time code to be output from the TIME CODE OUTPUT connector.

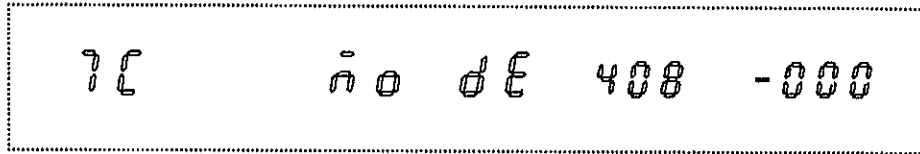

Setting number	Description
[000] (*)	REPRO (The time code for tape playback will be output.)
[001]	GEN TC (The time code of the INT generator will be output.)

■ <NOTE>

The default setting (REPRO) will be in effect whenever power is turned on.

■ **Setting of frame pulse output (SETUP "409- ****)**

This menu sets the frame pulse to be output from the EXT SYNC OUTPUT connector.

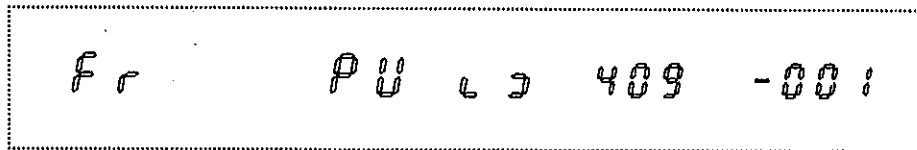

Setting number	Description
[001] (*)	F-SYNC (The frame sync signal of DAT Frame Sync will be output.)
[002]	TC FRAME (The frame pulse signal of the INT generator will be output.)

■ **Setting of the INT generator function mode (SETUP "410- ****)**

This menu sets REC MODE for the case of time code recording with INTERNAL GENERATOR.

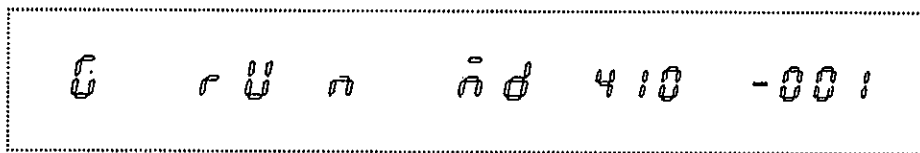

Setting number	Description
[001] (*)	FREE RUN (Time-up will be performed in synchronization to SYNC REFERENCE of the input when the generator is turned ON. This mode is intended for use when recording time code before insert editing.)
[002]	REC RUN (When playing back, JAM will be always performed at the time code recorded on tape. The generator will remain at rest in any other modes than recording. What is meant here is that when starting time code recording, time code will be generated without interruption from the already recorded code. This function will work on PLAY/RECORD mode, but not on STOP, FORWARD and REWIND modes. This mode is for use when recording time code continuously on tape, and often used for assemble editing.)

■ **Setting of the CHASE function mode (SETUP "501- ****")**

This menu sets the mode in which locking (chase lock) is made to external time code.

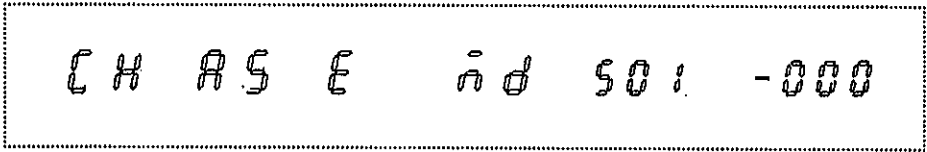

Setting number	Description
[000] (*)	1 time (Completion of 1 locking to REFERENCE TC after CHASE ON will release chase action, and this machine will start running on its own. No re-chase will be made if disengaged from lock.)
[001]	Continue (The D-25 will run on its own once locked to REFERENCE TC after CHASE ON. Going out of lock will result automatically in re-chasing.)
[002]	F-Sync. (Frame sync playback will be carried on with locking retained at a speed varying within a range where changes can not be sensed audibly. When an out-of-lock condition takes place, re-chase will begin automatically. Use of this mode is suggested when the sample clock of audio signals and time code clock are not in agreement and disengagement of locking results after running for an extended period of time.

■ **Setting of LOCK WINDOW (SETUP "502- ****")**

This menu sets the reference frame with which the unlocking condition can be set after CHASE lock.

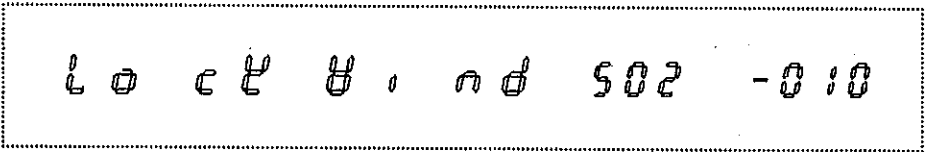

Setting number	Description
[001] ⋮ [020]	The reference frame can be set within a range of 1 to 20 frames in a unit of 1. (*010)

■ **Execution of the renumbering function (SETUP "601- EXC")**

This menu rewrites discontinuous P-No. to run continuously from the beginning.

To execute renumbering, press the EXECUTE key twice while this menu is on the display.

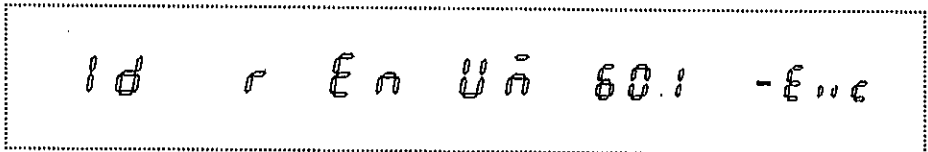

■ Execution of user memory ALL RESET (SETUP "801- EXC")

This menu resets (initializes) all time data and SETUP data memorized on the D-25.

To execute resetting, press the EXECUTE key twice while this menu is on the display.

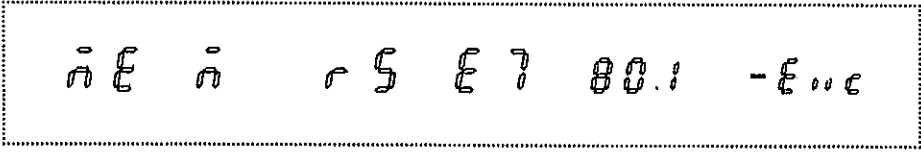

ãÉ ã r S E ? 80.1 -Exc

■ Service menu (SETUP "900- ***")

This menu is intended for service check use and will be shown on the display. Pressing the EXECUTE key with this menu on the display will get no response.



SE r ũ ic E 900 -Exc

Chapter 10
Specifications



Specifications

General

Recording Format	: IEC DIS DAT Standard Part 5
Recording Tape	: Digital Audio Tape
Number of Channels	: Audio x 2, Time Code x 1
Recording Time	: 120 minutes (for T-120 tape)
Head Composition	: Rotating 4 head
Error Correction	: Double Encoded Reed Solomon Code
Track Pitch	: 13.6 μ m
Sampling Frequency	: 48kHz, 44.1kHz
Modulation Type	: 8-10 Conversion
Transmission Rate	: 2.4Mbit/sec
Quantization	: 16 bit Linear
Emphasis	: 50 μ sec./15 μ sec.
Copy Guard	: Not Provided
Power Supply	: 120VAC 60Hz (AC inlet type) : 230V ~ 50/60Hz (AC inlet type) : 230V ~ 50Hz (AC inlet type)
Power Consumption	: 50W
Physical Dimensions	: 482 (W) x 142 (H) x 478 (D) mm
Weight	: Approx. 14kg

Mechanical

Motor Construction	: 2DD 4 Motors
Tape Speed	: 8.15 mm/sec
Fast Wind Time	: Approx. 80 seconds (for T-120 tape)
Search Speed/Fastwind Speed	: Max. 100 times
Loading System	: Front Loading Type,
Search Speed	: 1/2, 1, 2, 3, 5, 9, 16, 100 times
Vari Pitch Control	: -12.5% ~ +12.5% (Up to +5% at recording) * Vari pitch can be controlled by RS422 communication.

Memory Reproducing

Tape RAM	: 16M bit 10sec. (48kHz MAX.)
RAM Search Speed	: 0~1 times

External Sync

Sync Signal	: Composite, Frame Pulse, Field Pulse, WORD Sync
Frame Rate	: 24, 25, 29.97, 30, 48, 50, 59.94, 60 Hz (± 100 ppm), WORD Sync $\pm 12.5\%$

Electrical Characteristics

R/P Frequency Response	: 20Hz ~ 20kHz, ± 0.5 dB
S/N Ratio	: More than 90dB (Emphasis OFF)
Dynamic Range	: More than 90dB (Emphasis OFF)
Total Harmonic Distortion	: Less than 0.05% (1kHz, +4dBu)
Channel Separation	: More than 80dB (1kHz)
Wow and Flutter	: Less than $\pm 0.002\%$ WTD/peak
Standard Recording Level	: -20dB, -18dB, -12dB (Switchable) (0dB=16bit full scale level) (Default: -12dB)
Crossfade Time	: 0ms ~ 300 msec. (Default: 10msec.)
Meter Display	: FL, 28 segments (level) 7 seg. x 14 lines

Input and Output Connectors

Analog Audio Inputs

XLR-3-31 Type (3 points, switchable/Pin 2: HOT)	
Reference Input Level	: +4dBu/10k Ω (balanced) : +4dBm/600 Ω (balanced) : -10dBV/10k Ω (unbalanced, between HOT and GND)

Analog Audio Outputs

XLR-3-32 Type (Pin 2: HOT)	
Reference Output Level	: +4dBu/More than 600 Ω (balanced)

Monitor Outputs

ϕ 6 Standard Phone Jack	
Reference Output Level	: -10dBV/10k Ω (unbalanced)

Headphone Output

ϕ 6 Stereo Phone Jack	
Max. Output Level	: 100mW (at 32 Ω)
Output Load Impedance	: 8 Ω or more

Digital Input

XLR-3-31 Type	
Input Format	: Comply to AES/EBU specifications

Digital output

XLR-3-32 Type

Output Format : Comply to AES/EBU specifications

C-BIT : AES/EBU, IEC Consumer Switchable

Time Code Input

XLR-3-31 Type

Input Format : Comply to AES/EBU specifications

Reference Input Level : 2V p-p

Min. Input Level : 0.25V p-p

Input Impedance : More than 20k Ω

Reader Speed : 1/30 ~ 100 times (Forward/Reverse)

Time Code Output

XLR-3-32 Type

Output Format : Comply to AES/EBU specifications

Reference Output Level : 2V p-p

Output Impedance : More than 50 Ω **Time Code Thru**

XLR-3-32 Type

Reference Output Level : Direct output of TIME CODE Input.

VITC Input

BNC

Reference Input level : 1V p-p

Input Impedance : 75 Ω (ON-OFF switchable)**VITC Thru**

BNC

Reference Output : Direct output of VITC Input.

External Sync Input and Output Connector**WORD Input**

BNC

Reference Input Level : TTL Level

Input Impedance : 75 Ω (ON-OFF switchable)**WORD Thru**

BNC

Reference Output : Direct output of WORD Input.

WORD Output

BNC

Reference Output Level : TTL Level

Output Load Impedance : 75 Ω

VIDEO Input

BNC

Reference Input Level : TTL Level

Input Impedance : 75 Ω (ON-OFF switchable)

VIDEO Thru

BNC

Reference Output Level : Direct output of VIDEO Input.

DAT-Frame Input

BNC

Reference Input Level : TTL Level

Input Impedance : 75 Ω (ON-OFF switchable)

DAT-Frame Output

BNC

Reference Output Level : TTL Level

Output Load Impedance : 75 Ω

External Control Connectors

RS422 x 1

D-SUB 9PIN PROTOCOL : Comply to RS422 specifications

PROTOCOL : Comply to SONY 9 PIN PROTOCOL

Device Mode : Controlled

37 PIN REMOTE x 1

Input : Parallel Input

(+5V, 10k Ω , Pull up)

Output : Parallel Output

(Open collector, +5V, 10k Ω , Pull up)

GPI Output x 1

DIN 5PIN type : Open collector, +5V, 10k Ω , Pull up

* Specifications and physical appearance of this equipment is subject to change or improvement without advance notice.



Fostex

FOSTEX CO.

3-2-35, Musashino, Akishima-shi, Tokyo, Japan, 196-0021

FOSTEX AMERICA

13701 Cimarron Avenue, Gardena, CA 90249 U.S.A.