

Model 8360 Owner's Manual

(Ether card for the Model D2424 / D2424LV)

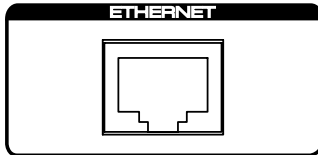

Table of Contents

Introduction	2
Installing the ether card	2
FTP client application	2
Connecting to a personal computer	3
One to one connection	3
Connection to an existing LAN	4
TCP/IP setting (recorder's initial setting)	5
IP address setting	6
Subnet mask setting	6
Anonymous setting	7
Login name (password) setting	7
Ether mode setting	8
Personal computer setting	9
TCP/IP setting	9
Setting for connection	9
Transferring files	10
Getting files from the recorder	10
Putting files to the recorder	11
Notes on transferring files	11

Fostex[®]

Introduction

Thank you very much for purchasing the Fostex product.

The Model 8360 is an ether card dedicated for the D2424/D2424LV digital multitrack recorder.

By installing the 8360 to the recorder, it can be used as an "FTP (File Transfer Protocol) server".

If you connect the recorder which is equipped with the ether card to a personal computer using a LAN cable, you can transfer audio files between the recorder and personal computer over the TCP/IP.

To transfer file data, an appropriate FTP client application must be used.

Installing the ether card

The ether card should be installed into the recorder at a Fostex service station. Do not try to install the card by yourself. Ask your local Fostex dealer for the installation after purchasing the Model 8360.

<Note>

By installing the ether card to the D2424/D2424LV, the "TCP/IP setting" menu is added to the setup mode on the recorder.

<Note>

There is the possibility of damaging the hard disk when transporting the recorder. Before transporting the recorder to our service department for the installation of the Ether Card, remove the hard disk from the recorder. Be sure to keep the removed hard disk carefully.

FTP client applications

Currently we confirm that the following FTP client applications can be used with the Model 8360.

- for Windows: **WS-FTP (shareware)**
- for Macintosh: **Fetch (shareware)**

<Note>

We confirm that the Windows FTP Explorer cannot be used with the Model 8360.

Connecting to a personal computer

There are two types for connecting the recorder to a personal computer using the LAN cable; one to one connection and LAN connection. The following describes how to make connection for each type.

One to one connection

To connect the recorder to a personal computer on a "one to one" basis, use a "cross cable of category 5 or higher" for connection between the recorder and a personal computer, as shown below.

To use the ether card as an FTP server, see "TCP/IP setting (recorder's initial setting)" and "Personal computer setting" described later.

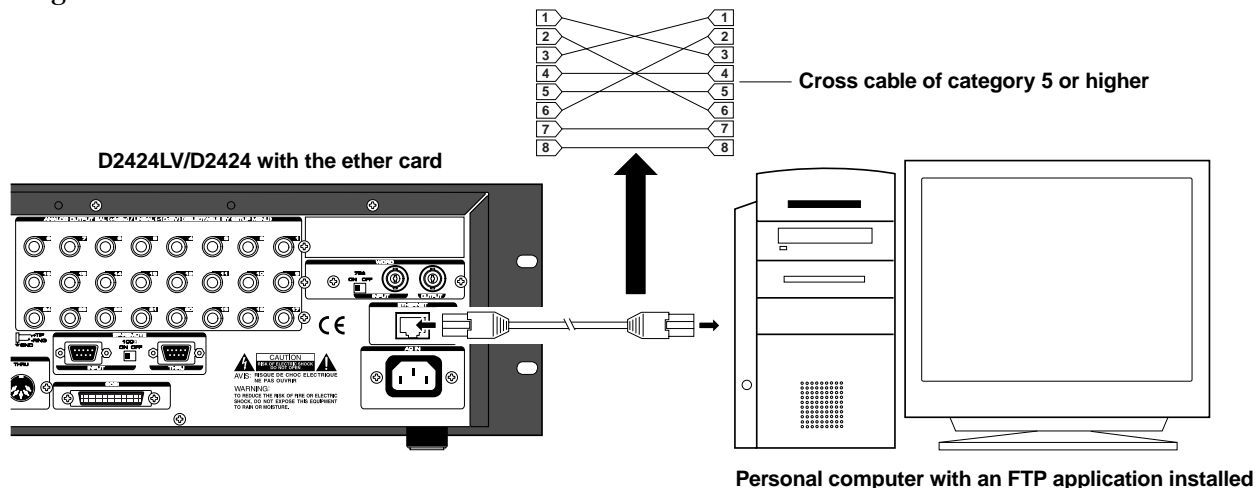

<Note>

A personal computer must be equipped with a LAN card which works correctly.

Connection to an existing LAN

To connect the recorder to an existing LAN, use a "straight cable of category 5 or higher" for connection between the recorder and a hub, as shown below.

<Note>

When connecting the recorder to an existing LAN, set the IP address and subnet mask correctly. Otherwise, whole LAN system may have a trouble. Before setting the IP address and subnet mask, consult the network administrator. To use the ether card as an FTP server, see "TCP/IP setting (recorder's initial setting)" and "Personal computer setting" described later.

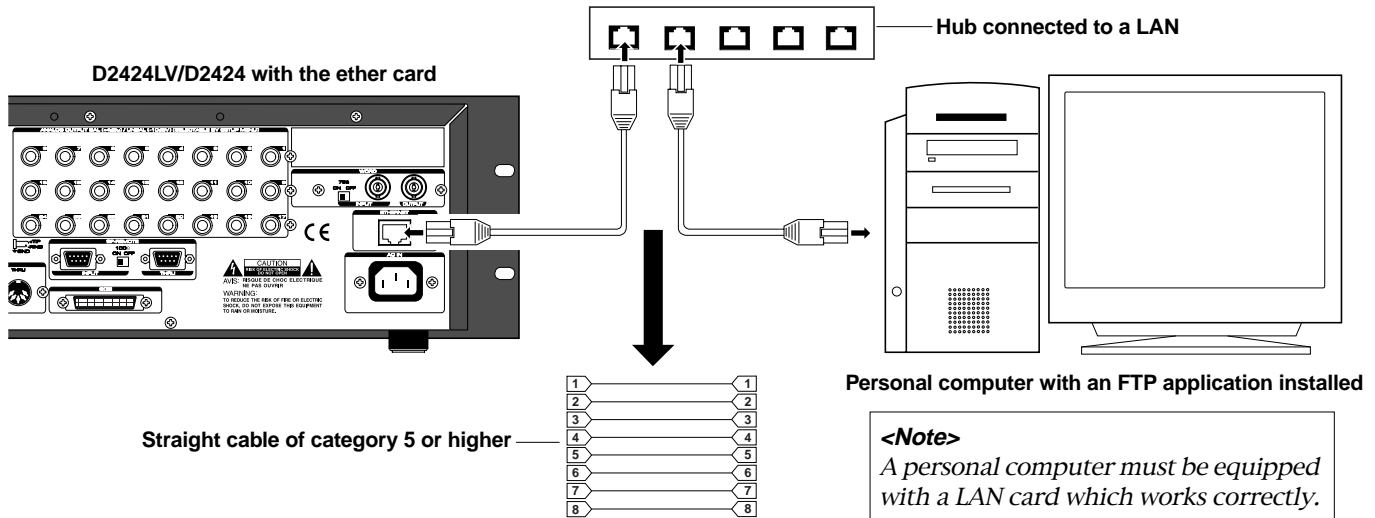

<Note>
A personal computer must be equipped with a LAN card which works correctly.

TCP/IP setting (recorder's initial setting)

Make the settings in the "TCP/IP Setup?" menu which is added to the setup mode of the recorder so that the Model 8360 can be used as an FTP server.

1. Turn on the recorder's power.
2. Press the [SETUP] key to enter the setup mode.
3. Use the JOG dial to bring up the "TCP/IP Setup?" menu and press the [EXECUTE/YES] key.

The first time you enter the TCP/IP setup mode, the display shows the screen for selecting the ether mode on or off.

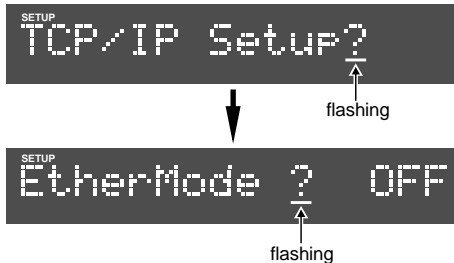

4. Use the JOG dial to select the screen from among those required for the TCP/IP setting.

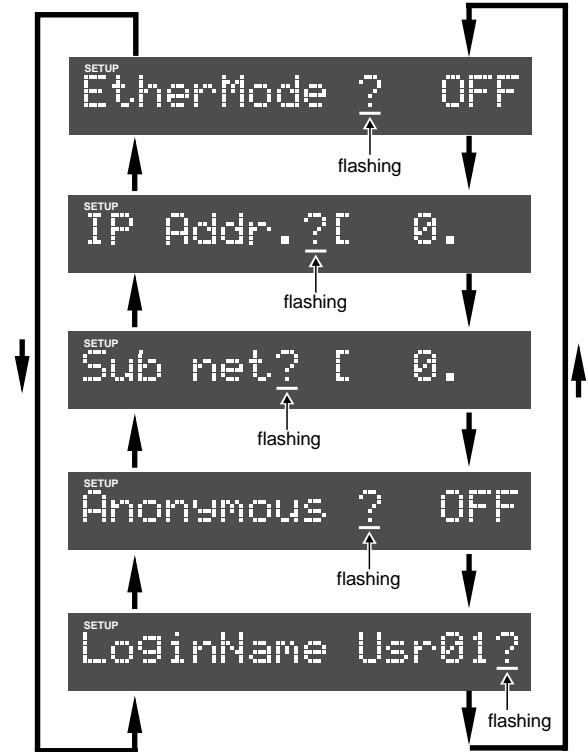

IP address setting

You must set the IP address for the recorder.

1. Use the JOG dial to bring up "IP Addr.?" and press the [EXECUTE/YES] key.

The display shows the screen for entering the IP address. By default, it is set to "0. 0. 0. 0" and the leftmost 0 flashes.

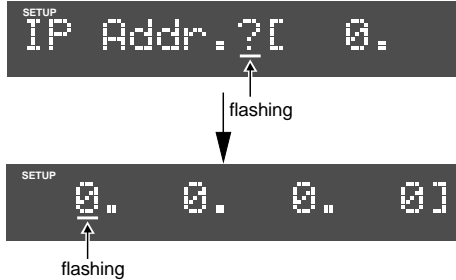

2. Use the shuttle to select the flashing digit and use the JOG dial to select the value.

When connecting the recorder to a personal computer on a "one to one" basis, set the IP address to "192. 168. 0. ***" (*** is any desired number between 1 and 254).

When connecting the recorder to an existing LAN, ask the administrator for the IP address.

3. After entering the IP address, press the [EXECUTE/YES] key.

The entered value is confirmed and the display shows "IP Addr.?".

Subnet mask setting

You must set the subnet mask value for the recorder.

1. Use the JOG dial to bring up "Sub net.?" and press the [EXECUTE/YES] key.

The display shows the screen for entering the subnet mask. By default, it is set to "0. 0. 0. 0" and the leftmost 0 flashes.

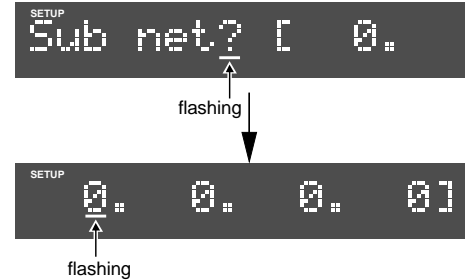

2. Use the shuttle to move the flashing digit and use the JOG dial to select a value.

When connecting the recorder to a personal computer on a "one to one" basis, set the IP address to "255. 255. 255. 0".

When connecting the recorder to an existing LAN, ask the administrator for the IP address.

3. After entering the subnet mask value, press the [EXECUTE/YES] key.

The entered value is confirmed and the display shows "Sub net ?".

Anonymous setting

This setting selects whether the 8360 checks the user name and password or not when logging in. If it is set to "ON", the 8360 does not check the user name and password, so you can access (log in) to the recorder with any user name and password (including no name/password).

1. Use the JOG dial to bring up "Anonymous?" and press the [EXECUTE/YES] key.

The current setting (ON or OFF) flashes (the default is "OFF").

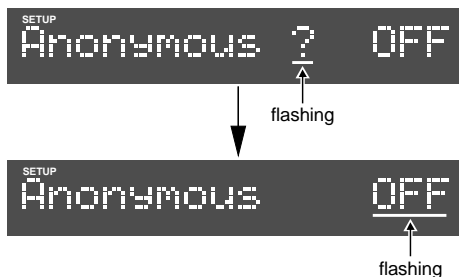

2. Use the JOG dial to select "ON" and press the [EXECUTE/YES] key.

The anonymous setting is completed and the display shows "Anonymous?".

Login name (password) setting

The login name and password are used when accessing (logging in) to the recorder from a personal computer. The 8360 allows to set a set of the login name and password.

<Note>

When the anonymous setting is set to "ON", you do not have to enter the login name and password.

1. Use the JOG dial to bring up "LoginName Usr 01?" and press the [EXECUTE/YES] key.

The display shows the screen for entering a login name, where the leftmost digit flashes initially.

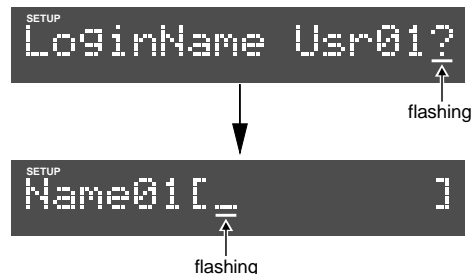

2. Use the shuttle to move the flashing digit and use the JOG dial to select a character.

You can enter up to eight characters for a login name.

3. **After entering the login name, press the [EXECUTE/YES] key.**

The display now shows the screen for entering a password, where the leftmost digit flashes initially.

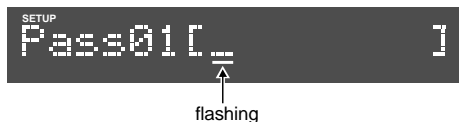

4. **Enter a password in the same manner as entering a password.**

You can enter up to eight characters for a password.

5. **After entering the password, press the [EXECUTE/YES] key.**

The display now shows "LoginName01 ?".

Ether mode setting

To activate the communication function of the Model 8360, you must set the ether mode to "ON".

<Note>

The settings previously described become effective when the ether mode is set to "ON".

1. **Use the JOG dial to bring up "EtherMode?" and press the [EXECUTE/YES] key.**

The current setting (ON or OFF) flashes (the default is "OFF").

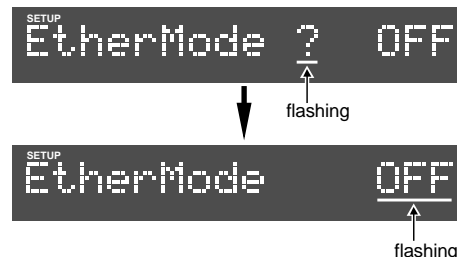

2. **Use the JOG dial to select "ON" and press the [EXECUTE/YES] key.**

The display returns to show "EtherMode?".

Personal computer setting

After completing the "TCP/IP Setup?" setting for the recorder, set the TCP/IP and connection settings for the personal computer.

TCP/IP setting

Set the IP address and subnet mask of the personal computer using the TCP/IP setting window of the personal computer.

- **IP address:** [192. 168. 0. ***]

*** is any of numbers between 1 and 254.

<Note>

You cannot set the same IP address for both the recorder and the personal computer.

- **Subnet mask value:** [255. 255. 255. 0]
- **Default gateway:** You do not have to set this.

Setting for connection

Activate the FTP application and make setting for connection as described below according to the application.

[for WS-FTP]

- **Profile Name:** Enter a desired name.
- **HostName/Address:** [192. 168. 0. ***]
*** must be the same number as set for the recorder.
- **HostType:** Automatic detect
- **Anonymous:** Enable
- **UserID, Password:** You do not have to set them.

[for Fetch]

Follow the procedure below.

- **From the "Custom" menu bar, select "new shortcut".**
- **Enter a desired name to the "Name" field.**
- **Set "Type" to "Folder".**
- **Enter the IP address for the recorder (192. 168. 0. ***) to the "Server name" field.**
- **You do not have to enter the "User name" and "Password" fields.**
- **Enter "/" (slash) to the "Directory" field.**

Transferring files

After making all necessary settings described earlier, make the following setting for the FTP application you use before opening the connection to transfer files.

[If you use WS-FTP]

From "ASCII", "Binary" and "Auto" shown in the center of the window, select "Binary" or "Auto".

[If you use Fetch]

Set "Mode" to "Auto" and "Type" to "Auto".

When you store a file to the D2424/D2424LV, set the "PutFile" dialog to "RawData".

Getting a file from the recorder

1. Log in to the D2424/D2424LV from the personal computer via the network.
2. Select the program folder in which the file to be acquired belongs to.
3. Set the transfer mode of the FTP application to "Binary" (or "Auto", if available).

Note: Do not select "ASCII" or "EBCDIC" for the transfer mode.

4. Get the desired track file(s).
5. Log out from the D2424/D2424LV.

<Files shown on the personal computer monitor>

On the personal computer monitor, you can see the file configuration of the recorder in the FTP application window. In the following example, programs 1 and 2 are recorded onto the recorder. (Note that, depending on the FTP application, the appearance is different.)

[program 1 contents]

Program name: AAA
Data is recorded on tracks 1 through 4.

[program 2 contents]

Program name: BBB
Data is recorded on tracks 1 through 16.

- "/" is shown on the icon of the uppermost directory.
- Each program corresponds to each folder. The folder name is shown as "(program name)_(program number)".
- Each track in the program is shown as "tr (track number).wav".
- The permission of an existing file or folder is set to "read-only".

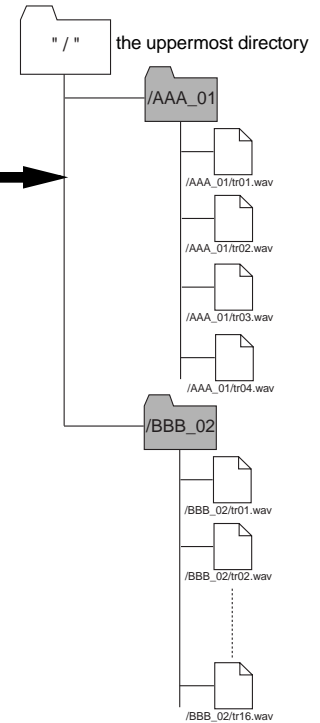

Putting files to the recorder

1. Log in to the D2424/D2424LV from the personal computer via the network.
2. Select the program folder to which you are going to put the file.

If you want to put the file to a new program, create a new folder. Specify only a program name as the folder name. You do not need to specify a program number. When you create a folder to which only the program name is specified, the recorder automatically adds the program number to the name (you cannot specify a desired program number).

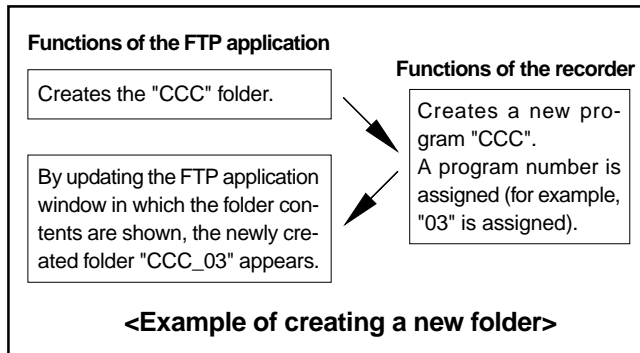

3. Set the transfer mode of the FTP application to "Binary" (or "Auto").
4. Put the desired track file(s) to the recorder.
5. Log out from the D2424/D2424LV.

Notes on transferring files

1. A file name must be "tr (track number).wav". Other file names cannot be accepted.
2. Only a mono-track, 16/24-bit, 96/88.2/48/44.1-kHz WAV file can be transferred (for both direction).
3. If a track WAV file, which has the different quantization bit size from the recorder's hard disk format, is sent to the recorder from a personal computer using FTP, it is not accepted. For example, you cannot store 24-bit file data to a 16-bit formatted hard disk on the recorder using FTP.
4. If a track WAV file, whose Fs is different from the track data already stored on the recorder's hard disk, is sent to the recorder from a personal computer using FTP, the file is stored with the original Fs. Therefore, when the program is played back, only the associated track is played back as if it is pitch-controlled. For example, if you store 48-kHz data for track 16 ("tr16.wav") to an existing program with 44.1-kHz track data, track 16 is stored with 48-kHz data.
5. If the combination of the program name which is set as the folder name and program number does not match the data stored in the recorder, you cannot store the file. In such a case, update the personal computer monitor window which shows the folder contents of the FTP application, then carry out the store operation again.
6. Because the permission of existing track files on the recorder is read-only, you cannot overwrite the file. Each track data in a program is stored as an individual WAV file, therefore, you can store only a WAV file of the track whose WAV file does not exist on the recorder. For example, if WAV files for tracks 1 through 10 on the program are stored, you can store the track 11 WAV file ("tr11.wav").

Declaration of EC Directive

This equipment is compatible with the EMC Directive (89/336/EEC) - Directive on approximation of member nation's ordinance concerning the electromagnetic compatibility. This equipment is compatible only when connected to fostex specified product.

The Affect of Immunity on This Equipment

The affect of the European Specification EN50082-1 (coexistence of electromagnetic waves - common immunity specification) on this equipment are as shown below.

In the electrical fast transient/burst requirements, surge, conducted disturbances by radio-frequency fields, power frequency magnetic field, radiate electromagnetic field requirements and static electricity discharging environment, this could be affected by generation of noise.

FOSTEX DISTRIBUTORS LIST IN EUROPE * Including non-EU countries. (As of August, 2002)

<AUSTRIA>

NAME: ATEC Audio-u. Videogeraete VertriebsgesmbH.
ADD: Im Winkel 5, A-2325 Velm, Austria
TEL: (+43) 2234-74004, FAX: (+43) 2234-74074

<BELGIUM>

NAME: EML Sound Industries NV
ADD: Bijvenestraat 1A, B3500 Hasselt, Belgium
TEL: (+32) 11-232355, FAX: (+32) 11-232172

<DENMARK>

NAME: SC Sound ApS
ADD: Malervej 2, DK-2630 Taastrup, Denmark
TEL: (+45) 4399-8877, FAX: (+45) 4399-8077

<FINLAND>

NAME: Noretron Oy Audio
ADD: P. O. Box 22, FIN-02631 Espoo, Finland
TEL: (+358) 9-5259330, FAX: (+358) 9-52593352

<FRANCE>

NAME: Guillard Musiques
ADD: ZAC de Follieuses, B. P. 609, Les Echets, 01706 Miribel France
TEL: (+33) 472 26 27 00, FAX: (+33) 472 26 27 01

<GERMANY>

NAME: Studiosound & Music GmbH
ADD: Industriestrasse 20, D-35041 Marburg, F. R. Germany
TEL: (+49) 6421-92510, FAX: (+49) 6421-925119

<GREECE>

NAME: Bon Studio S. A.
ADD: 6 Zaimi Street, Exarchia, 106.83 Athens, Greece
TEL: (+30) 1-3809605-8, 3302059
FAX: (+30) 1-3845755

<ICELAND>

NAME: I. D. elrf. electronic Ltd.
ADD: ARMULA 38 108 REYKJAVIK, ICELAND
TEL: (+354) 588 5010, FAX: (+354) 588 5011

<ITALY>

NAME: Proel S.p.A.
ADD: Zona Via Alla Ruenia, 37/43 64027 - Sant'Omero (Teramo), Italy
TEL: (+39) 0861-81241, FAX: (+39) 0861-887862

<THE NETHERLANDS>

NAME: IEMKE ROOS AUDIO B. V.
ADD: Kuiperbergweg 20, 1101 AG Amsterdam, The Netherlands
TEL: (+31) 20-697-2121, FAX: (+31) 20-697-4201

<NORWAY>

NAME: Siv. Ing. Benum A/S
ADD: P. O. Box 145 Vinderen, 0319 Oslo 3, Norway
TEL: (+47) 22-139900, FAX: (+47) 22-148259

<PORTUGAL>

NAME: Caius - Tecnologias Audio e Musica, Lda.
ADD: Rua de Santa Catarina, 131 4000 Porto, Portugal
TEL: (+351) 2-2086009/2001394,
FAX: (+351) 2-2054760/2087488

<SPAIN>

NAME: Multitracker, S. A.
ADD: C/Garcilaso No.9, Madrid 28010, Spain
TEL: (+34) 91-4470700, 91-4470898
FAX: (+34) 91-5930716

<SWEDEN>

NAME: TTS Scandinavia AB
ADD: Kavallerivagen 24, 172 48 Sundbyberg, Sweden
TEL: (+46) 8-59798000, FAX: (+46) 8-59798001

<SWITZERLAND>

NAME: Audio Bauer Pro AG
ADD: Bernerstrasse-Nord 182, CH-8064 Zurich, Switzerland
TEL: (+41) 1-4323230, FAX: (+41) 1-4326558

<UK>

NAME: SCV London
ADD: 40 Chigwell Lane, Oakwood Hill Industrial Estate, Loughton, Essex IG10 3NY U.K.
TEL: (+44) 020-8418-0778, FAX: (+44) 020-8418-0624