

# Owner's Manual

Model

# 454

Recording Mixer

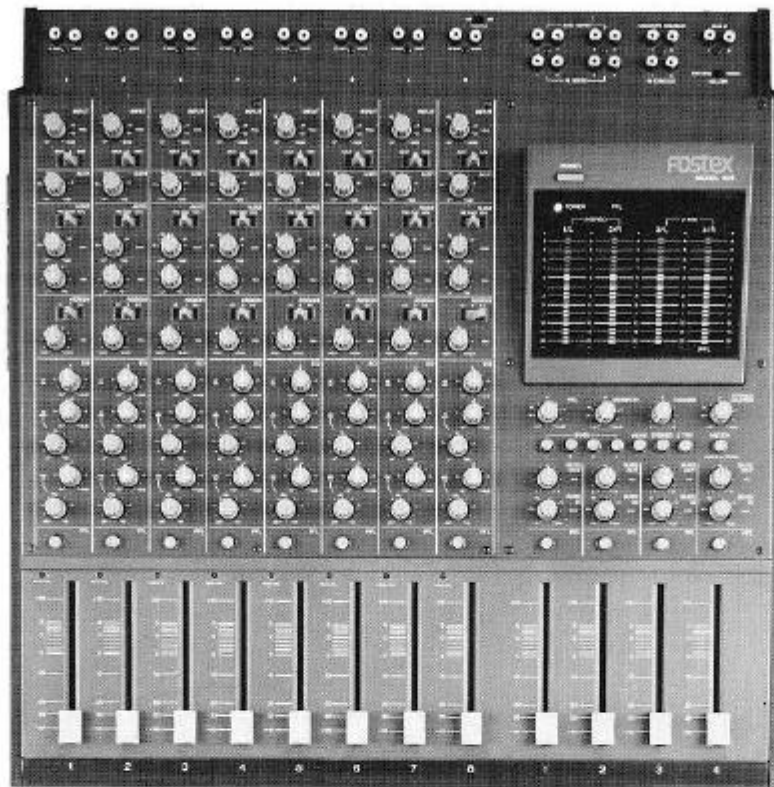

# Fostex



**CAUTION**  
RISK OF ELECTRIC SHOCK  
DO NOT OPEN



**CAUTION: TO REDUCE THE RISK OF ELECTRIC SHOCK,  
DO NOT REMOVE COVER (OR BACK).  
NO USER-SERVICEABLE PARTS INSIDE.  
REFER SERVICING TO QUALIFIED SERVICE PERSONNEL.**



The lightning flash with arrowhead symbol, within an equilateral triangle, is intended to alert the user to the presence of uninsulated "dangerous voltage" within the product's enclosure that may be of sufficient magnitude to constitute a risk of electric shock to persons.



The exclamation point within an equilateral triangle is intended to alert the user to the presence of important operating and maintenance (servicing) instructions in the literature accompanying the appliance.

### **"WARNING"**

"TO REDUCE THE RISK OF FIRE OR ELECTRIC SHOCK,  
DO NOT EXPOSE THIS APPLIANCE TO RAIN OR MOISTURE."

## **SAFETY INSTRUCTIONS**

1. **Read Instructions** – All the safety and operating instructions should be read before the appliance is operated.
2. **Retain Instructions** – The safety and operating instructions should be retained for future reference.
3. **Heed Warnings** – All warnings on the appliance and in the operating instructions should be adhered to.
4. **Follow Instructions** – All operating and use instructions should be followed.
5. **Water and Moisture** – The appliance should not be used near water – for example, near a bathtub, washbowl, kitchen sink, laundry tub, in a wet basement, or near a swimming pool, and the like.
6. **Carts and Stands** – The appliance should be used only with a cart or stand that is recommended by the manufacturer.
7. **Wall or Ceiling Mounting** – The appliance should be mounted to a wall or ceiling only as recommended by the manufacturer.
8. **Ventilation** – The appliance should be situated so that its location or position does not interfere with its proper ventilation. For example, the appliance should not be situated on a bed, sofa, rug, or similar surface that may block the ventilation openings; or, placed in a built-in installation, such as a bookcase or cabinet that may impede the flow of air through the ventilation openings.
9. **Heat** – The appliance should be situated away from heat sources such as radiators, heat registers, stoves, or other appliances (including amplifiers) that produce heat.
10. **Power Sources** – The appliance should be connected to a power supply only of the type described in the operating instructions or as marked on the appliance.
11. **Grounding or Polarization** – The precautions that should be taken so that the grounding or polarization means of an appliance is not defeated.
12. **Power Cord Protection** – Power supply cords should be routed so that they are not likely to be walked on or pinched by items placed upon or against them, paying particular attention to cords at plugs, convenience receptacles, and the point where they exit from the appliance.
13. **Cleaning** – The appliance should be cleaned only as recommended by the manufacturer.
14. **Nonuse Periods** – The power cord of the appliance should be unplugged from the outlet when left unused for a long period of time.
15. **Object and Liquid Entry** – Care should be taken so that objects do not fall and liquids are not spilled into the enclosure through openings.
16. **Damage Requiring Service** – The appliance should be serviced by qualified service personnel when:
  - A. The power supply cord or the plug has been damaged; or
  - B. Objects have fallen, or liquid has been spilled into the appliance; or
  - C. The appliance has been exposed to rain; or
  - D. The appliance does not appear to operate normally or exhibits a marked change in performance; or
  - E. The appliance has been dropped, or the enclosure damaged.
17. **Servicing** – The user should not attempt to service the appliance beyond that described in the operating instructions. All other servicing should be referred to qualified service personnel.

## Introduction

Thank you for purchasing the Fostex Recording Mixer, Model 454. Model 454 is an 8-input type sophisticated recording mixer complete with various functions such as over dubbing, ping pong recording, and mix down which are necessary for multi-track recording. It can also be used in a variety of fields other than recording. By using a phantom power XLR connector, the solid specs of this model such as, the stereo/monitor with various output functions, the PFL (Pre-Feeder Listen) functions, and the 2-channel AUX OUT, etc., definitely supports the needs necessary for various production steps.

Furthermore, you can choose from two types of LED bar graph meters (normal display, peak hold display) and through use of the meter selector and PFL button, it becomes compatible with various output or PFL level displays.

Please thoroughly read this manual before using the machine to fully understand the operation procedures. Furthermore, we hope that you will take care of this machine, and that you will enjoy it to its maximum potential.

## SPECIFICATIONS

### INPUT (X8)

Microphone impedance	: less than 10k $\Omega$
Input impedance	: 7k $\Omega$ balanced type XLR connector and 16k $\Omega$ unbalanced type phone jack
Nominal input level	: Microphone: -60dBV (1mV) Line: -10dBV (0.3V) Variable
Minimum input level	: -70dBV (0.3mV)
Maximum input level	: +15dBV (5.6V)

### TAPE INPUT (X 8)

Input impedance	: 20k $\Omega$
Nominal input level	: -10dBV (0.3V)
Minimum input level	: -20dBV (0.1V)
Maximum input level	: +25dBV (17.8V)

### 4 CHANNEL BUSS INPUT (X 4)

Input impedance	: 10k $\Omega$
Nominal input level	: -10dBV (0.3V)
Maximum input level	: +25dBV (17.8V)

### STEREO INPUT (X 2)

Input impedance	: 20k $\Omega$
Nominal input level	: -10dBV (0.3V)
Maximum input level	: +15dBV (5.6V)

### INSERT INPUT (RECEIVE X 8)

Input impedance	: 20k $\Omega$
Nominal input level	: -10dBV (0.3V)

### INSERT OUTPUT (SEND X 8)

Output load impedance	: more than 10k $\Omega$
Nominal output level	: -10dBV (0.3V)
Maximum output level	: +15dBV (5.6V)

### MONITOR OUTPUT (X 2)

Output load impedance	: more than 10k $\Omega$
Nominal output level	: -10dBV (0.3V)
Maximum output level	: +10dBV (3V)

### HEADPHONES OUTPUT (Stereo)

Output load impedance	: 8 $\Omega$ ~ 40 $\Omega$
Maximum output	: 100mW (8 $\Omega$ ~ 40 $\Omega$ )

## Contents

Specifications	2
Block Diagram	3
Description and Function of Various Parts/Operation Procedures	4
Connections to External Equipment	9
Connection to Various Effectors	9
About the Parametric Equalizer	11
Other Uses	12
Multitrack Recording	13
I. Basic Track Recording	15
II. Overdubbing	18
III. Ping Pong Recording	19
IV. Mixdown	20
Trouble Shooting (before thinking, "is it broken?")	22

### FREQUENCY RESPONSE

Microphone input	: 20Hz ~ 20kHz $\pm$ 2dB
Line input	: 20Hz ~ 20kHz +1/-2dB
Headphones output	: 30Hz ~ 20kHz +1/-2dB

### 2 TRACK INPUT (X 2)

Input impedance	: 20k $\Omega$
Nominal input level	: -10dBV (0.3V)

### 4 CHANNEL BUSS OUTPUT/STEREO OUTPUT/DIRECT OUTPUT

Output load impedance	: more than 10k $\Omega$
Nominal output level	: -10dBV (0.3V)
Maximum output level	: +15dBV (5.6V)

### AUX 1, AUX 2 (X 2) BUSS OUTPUT

Output load impedance	: more than 10k $\Omega$
Nominal output level	: -10dBV (0.3V)
Maximum output level	: +15dBV (5.6V)

### SIGNAL TO NOISE RATIO

Equivalent input noise	: -126dB weighted -124dB unweighted (20Hz ~ 20kHz)
1 mic input	: 68dB weighted 67dB unweighted
8 mic inputs	: 58dB weighted 56dB unweighted
1 line input	: 86dB weighted 85dB unweighted
8 line inputs	: 76dB weighted 74dB unweighted

T.H.D. (overall)	: 0.05% (1kHz, nominal level) 0.1% (headphones: 1kHz, 100mW/40 $\Omega$ )
------------------	--

PARAMETRIC EQUALIZER	: 60 ~ 1kHz $\pm$ 15dB 400 ~ 6kHz $\pm$ 15dB 10kHz $\pm$ 15dB
----------------------	---

CROSSTALK	: 60dB (1kHz)
FADER ATTENUATION	: more than 70dB (1kHz)

POWER REQUIREMENTS	: 120V AC, 60Hz, 20W
DIMENSIONS	: 220V AC, 50Hz, 20W 240V AC, 50Hz, 20W

(H X W X D)	: 117 X 550 X 546 (mm)
WEIGHT	: 12kg

PHANTOM POWER SUPPLY	: DC24V
----------------------	---------

# Block Diagram

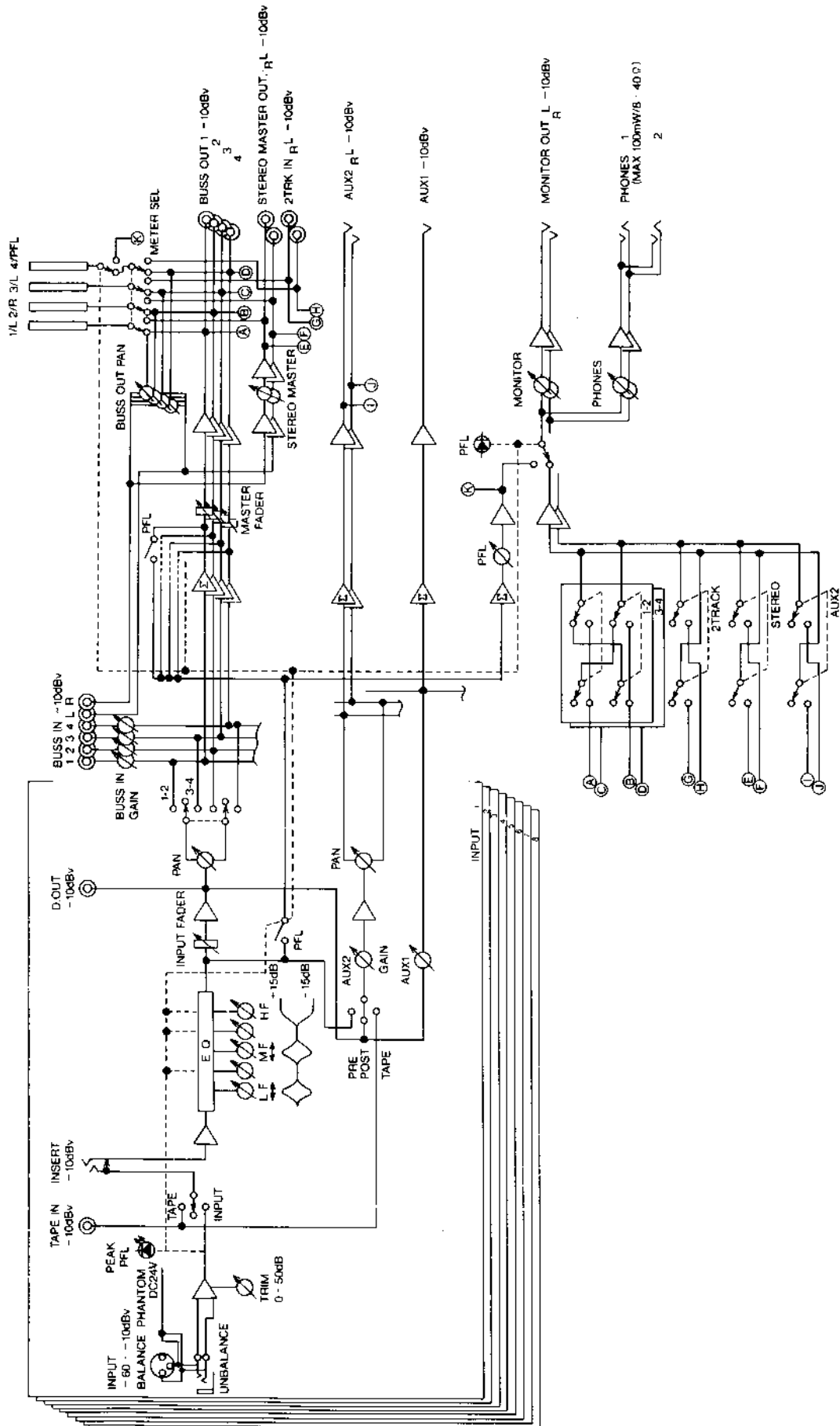

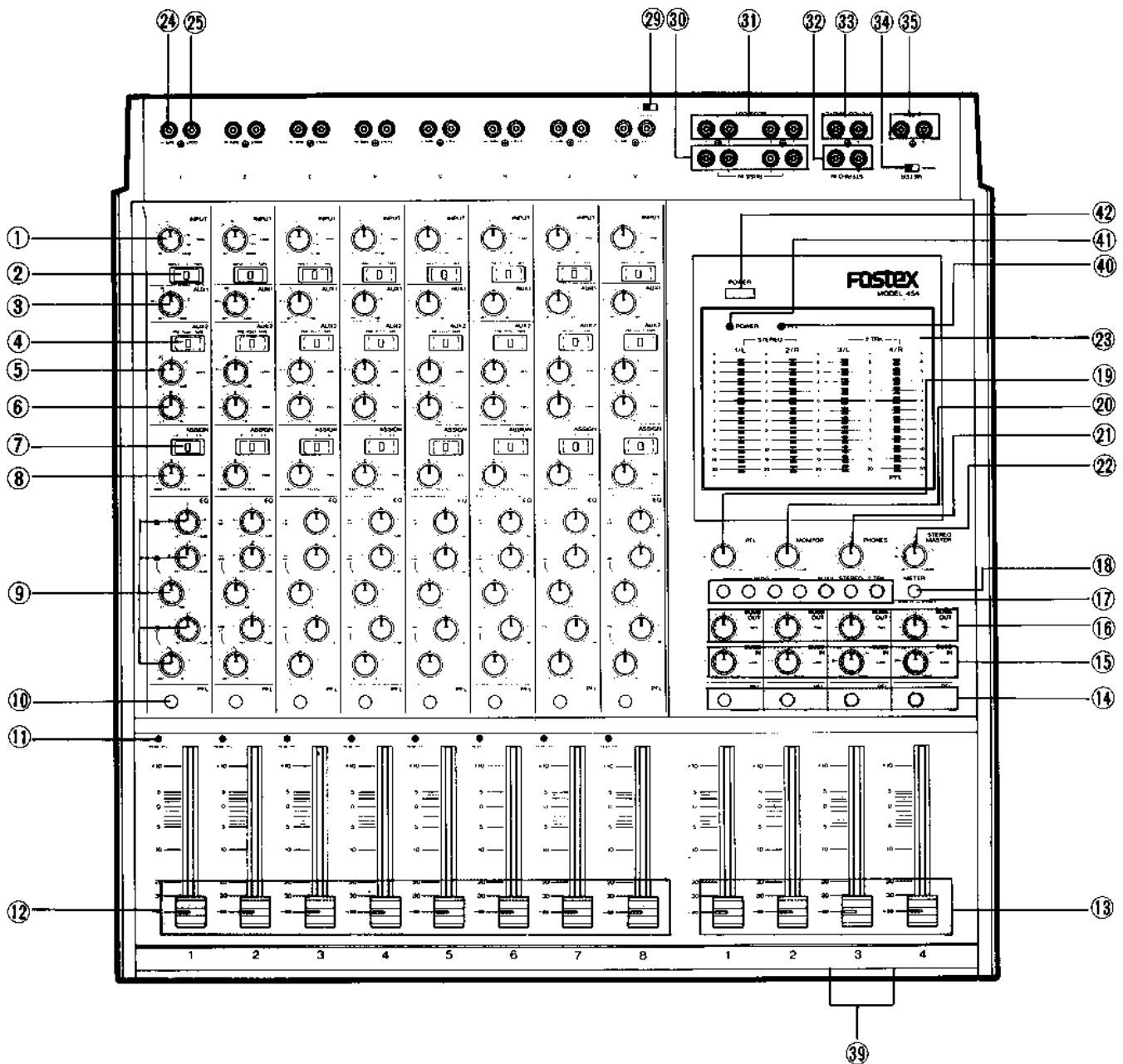
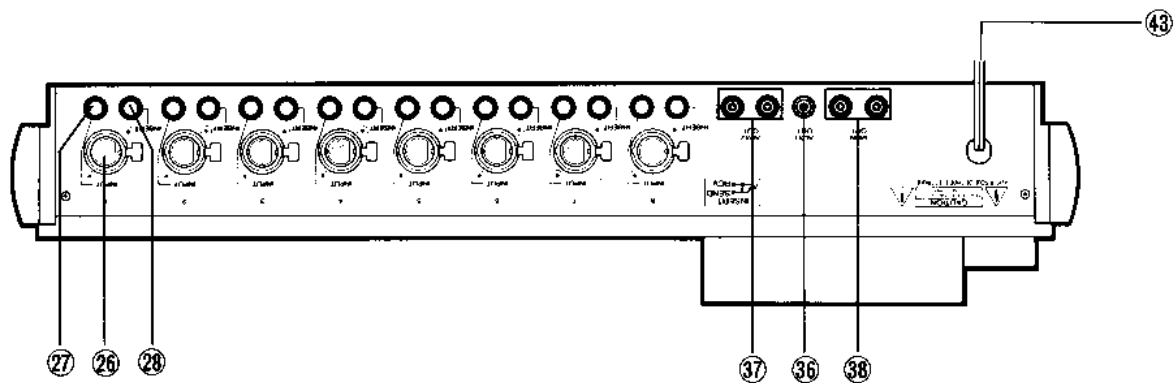

## Description and Function of Various Parts/Operation Procedures

The ( ), indicates the actual name on the panel to make the procedures easier to follow. This manual prioritizes the use of the actual panel description. (Example: EQ ⑨ or PHONES ⑳).

### 1. Input Trim (TRIM)

This is used to make fine gain adjustments on the pre amplifier, to allow the input signal from the *INPUT jacks* ②⑥ or ②⑦ to be set at its optimum level. It complies with a broad range of inputs from the mic level (−60 dBV) to the line level (−10 dBV). Furthermore, it doesn't effect the input levels of the *TAPE IN jack* ②④.

### 2. Input Selector (INPUT, ●, TAPE)

This switch converts the input signal.

**INPUT:** The input signals of the *XLR INPUT jack* ②⑥ or *INPUT jack* ②⑦ are connected.

●: Signal OFF.

**TAPE:** The input signal from the *TAPE IN jack* ②④ is connected.

### 3. AUX 1 Level Knob (AUX 1)

This knob adjusts the mixed signal which is sent to the *AUX buss 1* after passing (post equalizer, post fader) the *EQ* ⑨ and *INPUT fader* ⑫ of each channel. The signal sent to the *AUX buss 1* is output from the *AUX out jack 1*.

### 4. AUX 2 Input Selector (AUX 2)

This switch converts the input signal sent to the *AUX buss 2*. Use this function for monitoring tape signals when overdubbing or sending those signals to effectors when mixing down.

**PRE:** The signal after passing the *EQ* ⑨, but not passing the *INPUT fader* ⑫ is connected.

**POST:** The signal after passing both the *EQ* ⑨ and the *Input fader* ⑫ is connected.

**TAPE:** The input signal from the *TAPE IN jack* ②④ is connected. Use as a tape monitor during over dubbing.

### 5. AUX 2 Level Knob (GAIN)

This knob adjusts the level of the signal chosen at ④.

### 6. AUX Pan Pot (PAN)

Sets the position of the left/right signal level chosen at the *AUX 2 input selector* ④ and set at *AUX 2 level knob* ⑤, when sending to the *AUX buss 2*.

### 7. Assign Switch (ASSIGN)

In connection with the *PAN pot* ⑤, this switch selects the output to the 4 busses, 1, 2, 3, and 4. It is a 3-mode switching, 1-2, OFF and 3-4.

### 8. 4-Channel Buss Pan Pot (PAN)

In correlation to the *ASSIGN switch* ⑦, this switch functions as shown in the following figure.

Example: When choosing 1-2 with the assign switch ⑦.

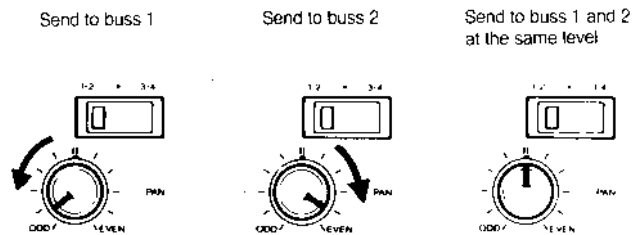

As shown, the sound can be freely positioned by using the *Pan pot* ⑤.

### 9. Parametric Equalizer (EQ)

Adjusts the tone of the signals sent to the *INPUT fader* of each channel. For more information, refer to page. 11 "About the Parametric Equalizer".

### 10. Input Pre-Fader Listen Button

When this button is pressed, only the input signal of the pre-fader (post equalizer) of the channel can be monitored at the center. Furthermore, if any of these buttons are selected, the *PFL* portion of the *meter* ⑲, automatically displays the mixed signal of the *PFL buss*, so it is convenient when verifying the pre-fader level of each channel. This function works only with monitor-channels (*Monitor Out jack* ⑳, *PHONES jack 1, 2* ㉑, *meter* ⑲) and doesn't affect other outputs.

### 11. Peak/Pre-Fader Listen LED (PEAK/PFL)

When the signals from the *INPUT jack* ②⑥ and ②⑦ are overloading, this LED will light up (when the signals overloading not only in the pre-amplifier portion, but also in the *EQ* ⑨). Or it will also light indicating the condition of *PFL* signals when the *PFL Button* ⑩ or ⑬ pressed down.

## 12. Input Fader

The signal volume selected by *INPUT selector* ② is adjusted. The range between  $0 \pm 5$  (dB) is the position with minimal noise/distortion, so when adjusting the input level, set it within this range, then set *TRIM* ①.

## 13. 4-Channel Buss Master Fader

This is the master fader for each 4-channel buss. It adjusts the output level of the *BUSS OUT jacks 1 to 4* ⑩.

## 14. 4-Channel Buss Pre-Fader Listen Button (PFL)

When this button is pressed, only the output signal of the selected 4-channel buss which is not passing the master fader is monitored. Furthermore, Even if one of these buttons is selected, the *meter* ⑭ on the PFL portion will automatically display the level of the mixed signal of the PFL buss. As with the functions of the *PFL button* ⑩, this only applies to the monitor-channels.

## 15. 4-Channel Buss-In-Gain Knob (BUSS IN GAIN)

This knob adjusts the level of the input signals from the *BUSS IN jacks 1 to 4* ⑪. It is used to set the signal levels from effectors or other mixers.

## 16. 4-Channel Buss-Out-Pan Pot (BUSS OUT PAN)

Sets the position of each buss signal when mixing the output signals of the 4-channel buss (the signal passing the *4CHAN BUSS master fader* ⑬) to the *STEREO MASTER OUT jack* ⑳ and sending them out.

## 17. Monitor Selector

Chooses the signal to be sent to the *MONITOR OUT jack* ⑳ and *PHONES jack 1 to 2*. These switches are categorized into 5 groups, and depending on your selection, it will be output as shown below.

**BUSS 1 and 2, BUSS 3 and 4:** You can monitor the signals output from *BUSS OUT jack 1 and 2, 3 and 4* ⑩. When two of these switches are simultaneously pressed, the sound position for 1, 3 will be from the left and 2,4 will be from the right. If only one is selected then it will be output from the center position.

**Example:**

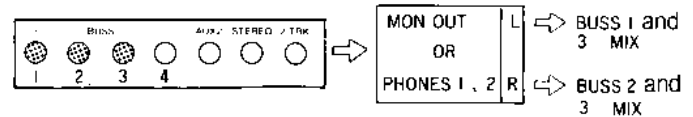
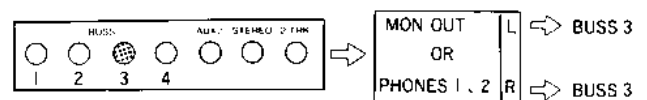
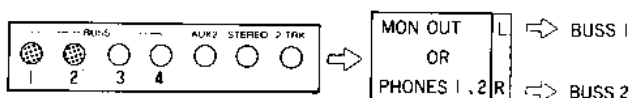

**AUX 2:** The signals output from the *AUX 2 OUT jack* ⑳ can be monitored at its present position.

**STEREO:** The signal output from the *STEREO MASTER OUT jack* ⑳ can be monitored at its present position.

**2 TRACK:** The signal input from the *2 TRACK IN jack* ㉑ can be monitored at its present position.

If several switches of these 5 groups are simultaneously pressed, it will be mixed according to the above mentioned conditions, then it will be sent to the *MON OUT jack* and *PHONES OUT jack*.

## 18. Meter Selector (METER)

The display of *meter* ⑭ can be selected.

**BUSS:** Displays the output level of the *BUSS OUT jack 1 to 4* ⑩.

**STEREO:** Orderly from the left of the meter, it displays the L/R output level of the *STEREO MASTER OUT jack* ⑳ and the L/R input level of the *2 TRK IN jack* ㉑.

## 19. Pre-Fader Listen Level Knob (PFL)

Adjusts the master level of the PFL buss. The overall volume can be set when the *PFL button* ⑩ and ⑬ is selected to monitor the PFL. Usually, the *MONITOR level knob* ⑳ and *PHONES level knob* ㉑ is set before adjusting this *PFL level knob*.

## 20. Monitor Level Knob (MONITOR)

Adjusts the output level of the signal output from the *MONITOR OUT jack* ⑳.

## 21. Headphones Level Knob (PHONES)

Adjusts the volume of the headphones connected to the *PHONES jack* ㉑.

## 22. Stereo Master Level Knob (STEREO MASTER)

Adjusts the output level of the signal output from the *STEREO MASTER OUT jack* ⑳.

### 23. LED Bar Graph Meter

Displays the output level selected by *Meter selector* ⑮. Furthermore, if even one *PFL button* ⑩ or ⑭ is selected, the PFL portion of the meter will display the mix signal level of the PFL buss.

### 24. Tape In Jack (TAPE IN)

The output (unbalanced) of the multitrack recorder is usually connected.

### 25. Direct Out Jack (D.OUT)

This is the output jack for the post fader (post equalizer) signals of each channel. It can be used to send the input signal to the effector etc.

### 26. XLR Input Jack (INPUT)

This is a XLR-type balanced (3rd pin: hot) input jack which is compatible with levels from mic levels to line levels. It is also capable of processing unbalanced input signals but in such case, the first and second pin will act as the GND, and the *PHANTOM POWER switch* ⑲ should always be OFF. Furthermore, When the plug is connected to the *phones INPUT jack* ⑳, priority is given to this process, and the input signals of this jack will not lead way to the other.

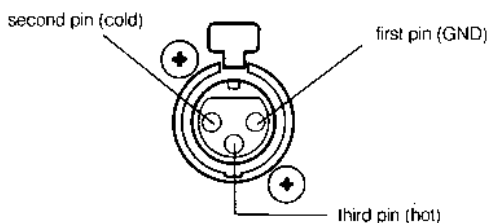

### 27. Phones Input Jack (INPUT)

This is a phone-type unbalanced input jack which is compatible with levels from mic levels to line levels. It also complies with balanced-type input signals, but in such case, the TIP is connected to the hot and the RING is connected to the cold.

### 28. Insert Jack (INSERT)

This stereo phone jack allows connection to such effectors as the compressor/limiter or the noise gate that process sound sources directly. When nothing is connected here, the signal will go thru the send and receive stage.

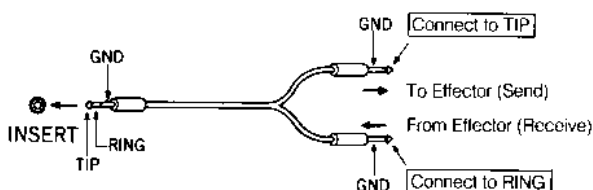

### 29. Phantom Power Switch (PHANTOM)

Supplies DC 24V of Phantom power to the microphone. Always turn it OFF when connecting dynamic microphones, etc. that don't require this power supply. When it is ON use the first pin as 0V and the DC 24V will be supplied to the second and third pin.

### 30. 4-Channel Buss In Jack (BUSS IN 1, 2, 3, 4)

This is the input jack for the 4CHAN buss 1 to 4. It is usually used to connect the effector output, and other mixer outputs, and the object for use is to mix to the 4CHAN buss.

### 31. 4-Channel Buss Out Jack (BUSS OUT 1, 2, 3, 4)

These are output jacks for the 4CHAN buss 1 to 4, used to send to the multitrack recorder.

### 32. Stereo In Jack (STEREO IN)

These inputs are used to mix the input signals from other mixers or effectors with the signals to the STEREO MASTER OUT jacks. Furthermore, the input signals from this STEREO IN jack is mixed in way to the STEREO MASTER level knob.

### 33. Stereo Master Out Jack (STEREO MASTER)

These are the output jacks for the signals of the 4CHAN buss mixed in the stereo. It is usually used to send signals to the master recorder.

### 34. Meter Mode Selector (METER)

**PEAK HOLD:** the display of the peak indication of the LED Bar Graph Meter is held for approximately 1.4 seconds.

**NORMAL:** Displays as a usual peak meter.

### 35. 2-Track In Jack (2 TRK IN)

The master recorder outputs are usually connected here. Choose from the *MONITOR selector* ⑰ and *Meter selector* ⑱, then the mixed-down master tape can easily be monitored.

### 36. AUX 1 Out Jack (AUX 1 OUT)

This is the monaural output jack for AUX buss 1. This jack is used to send AUX buss 1 mixed signals to echo-type effectors, etc.

### 37. AUX 2 Out Jack (AUX 2 OUT)

These are the stereo output jacks for the AUX buss 2. This jack is used to send AUX buss 2 mixed signals to monitor amplifiers or effectors, etc.



### **38. Monitor Out Jack (MON OUT)**

The signals selected by the *MONITOR selector* (17) is output after passing through the *MONITOR level knob* (20). Furthermore, if even one *PFL button* (10) or (14) is pressed, the PFL buss output signal (the signal coming from the *PFL level knob* (19)) is output after passing through the *MONITOR level knob* (20).

### **39. Headphones Jack (PHONES)**

Both jacks output the same source as the *MONITOR OUT jack* (38).

### **40. Pre-Fader Listen Display LED (PFL)**

It will illuminate if any of *PFL button* (10) or (14) is pressed. When this LED is illuminating, the PFL buss output signal is automatically sent to the *MONITOR OUT jack* (38) and *PHONES jack* (39), and the PFL buss mixed signal level is displayed in the PFL portion of the *meter* (29).

### **41. Power LED (POWER)**

### **42. Power Switch (POWER)**

### **43. Electrical Cord**

## Connections to External Equipment

### 1. Impedance

When making connections to other equipment, be careful about the input/output impedance capability. Impedance is the resisting factor against the audio signals, and it is indicated by the  $\Omega$  (ohm) unit. If the output impedance and input impedance don't comply, it can cause distortion or even damage the equipment. Generally, the output impedance is low and the input impedance is high (low out, high in). Refer to page 8 "Specifications" for the input/output impedance of this machine.

**Note:** Always use the direct box when connecting amplifier outputs indicated in *Ws*, or musical instruments requiring high input impedances. Otherwise, the use may damage to this machine and the amplifier circuitry.

## Connection to Various Effectors

The present music production requires effectors with sophisticated functions such as digital reverb and delay, comp/limiter and noise gates. This machine has a

### 2. About the Level Adjustments With the External Equipment

Use the *TRIM* ① to adjust external equipment level, to this machine, connected to *INPUT jacks* ②⑥ and ⑦. Adjust the *PEAK/PFL LED* ⑪ so it won't illuminate during the peak signals. Since the range of  $0 \pm 5$  dB is the optimal range to minimize noise, it is advised that the *INPUT fader* ⑫ is priorly set within this range, then adjust the *TRIM* ①. It is convenient if you select the *PFL button* ⑩ at this time, because you can monitor the pre-fader level and sound pattern. But be careful since the *PEAK/PFL LED* ⑪ simply illuminates to indicate the PFL selection. Furthermore, the *PEAK/PFL LED* ⑪ will illuminate with *EQ* ⑨ overloading so when adjusting the *TRIM* ①, keep the various gains of the *EQ* ⑨ flat. Then after setting the *TRIM* ①, if the *PEAK/PFL LED* ⑪ illuminate at the *EQ* ⑨ portion, during *EQ* ⑨ sound adjusting, it is overloaded, so lower the gains or leave the gain at the present adjustment but readjust the *TRIM* ①.

The inputs and output other than the ones mentioned above are of standard level of  $-10$  dBV with low impedance capability, therefore, it can be connected to all FOSTEX recording equipment or other personal studio equipment. Furthermore, it may be necessary to connect an attenuator or line amplifiers when connecting machines with varying input/output levels (from the standard) or professional use machinery ( $+4$  dBm).

convenient *D.OUT jack* ⑮, *INSERT jack* ⑲, *AUX 1 OUT jack (mono)* ⑳, *AUX 2 OUT jack (stereo)* ㉑, *BUSS IN jack 1 to 4* ㉒ etc. to allow connection of the input/output from/to the effectors. Of that, the *AUX 1 OUT jack* ⑳ is for the post-fader mix, *AUX 2 OUT jack* ㉑ is for the pre-fader, post-fader and tape monitor. This machine complies to a variety of uses. For the effector return, the *BUSS IN jack 1 to 4* ㉒ or *STEREO IN jack* ㉓ is usually used, but if there are more returns, it is convenient if you initially gather them in another mixer (FOSTEX 2016, etc.) then return it to this machine.

The following will indicate the specifics for connection.

# 1. When using an effector for independent input channels

This connection is effective for effectors processing the sound source directly  
 example: delay  
 reverb  
 chorus etc.  
 example: comp/limiter  
 noise gate, etc.

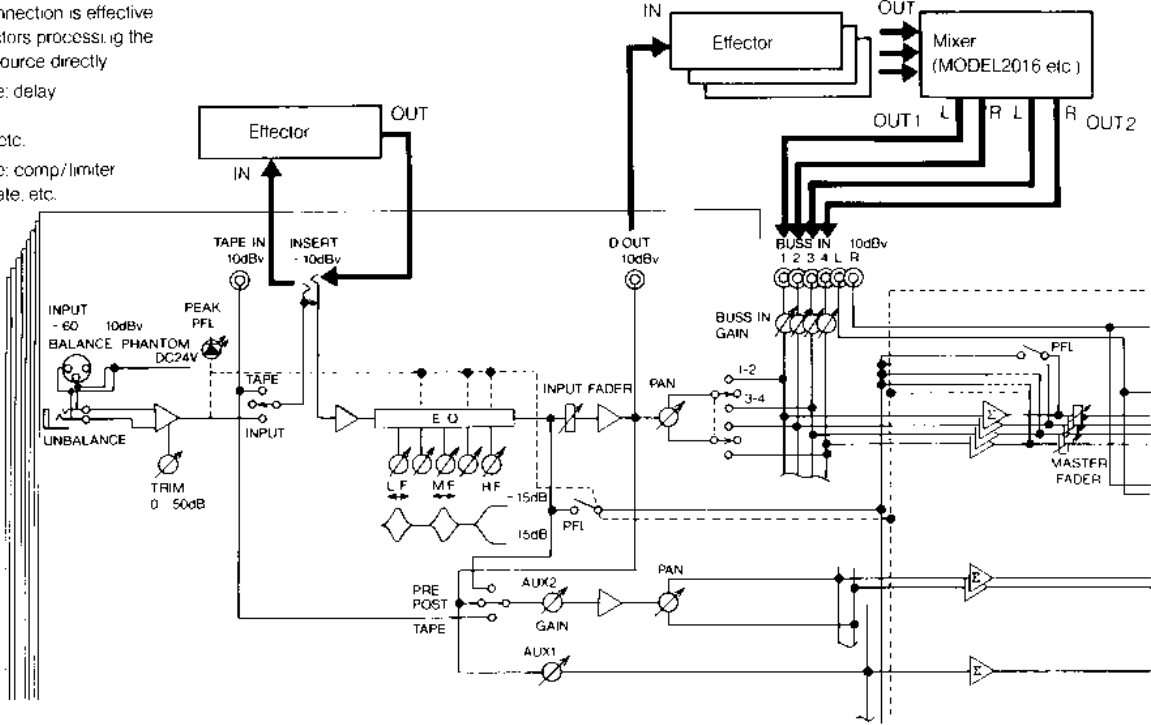

# 2. Each channel of the effectors common to all input channels is independently processed for the positioning degree.

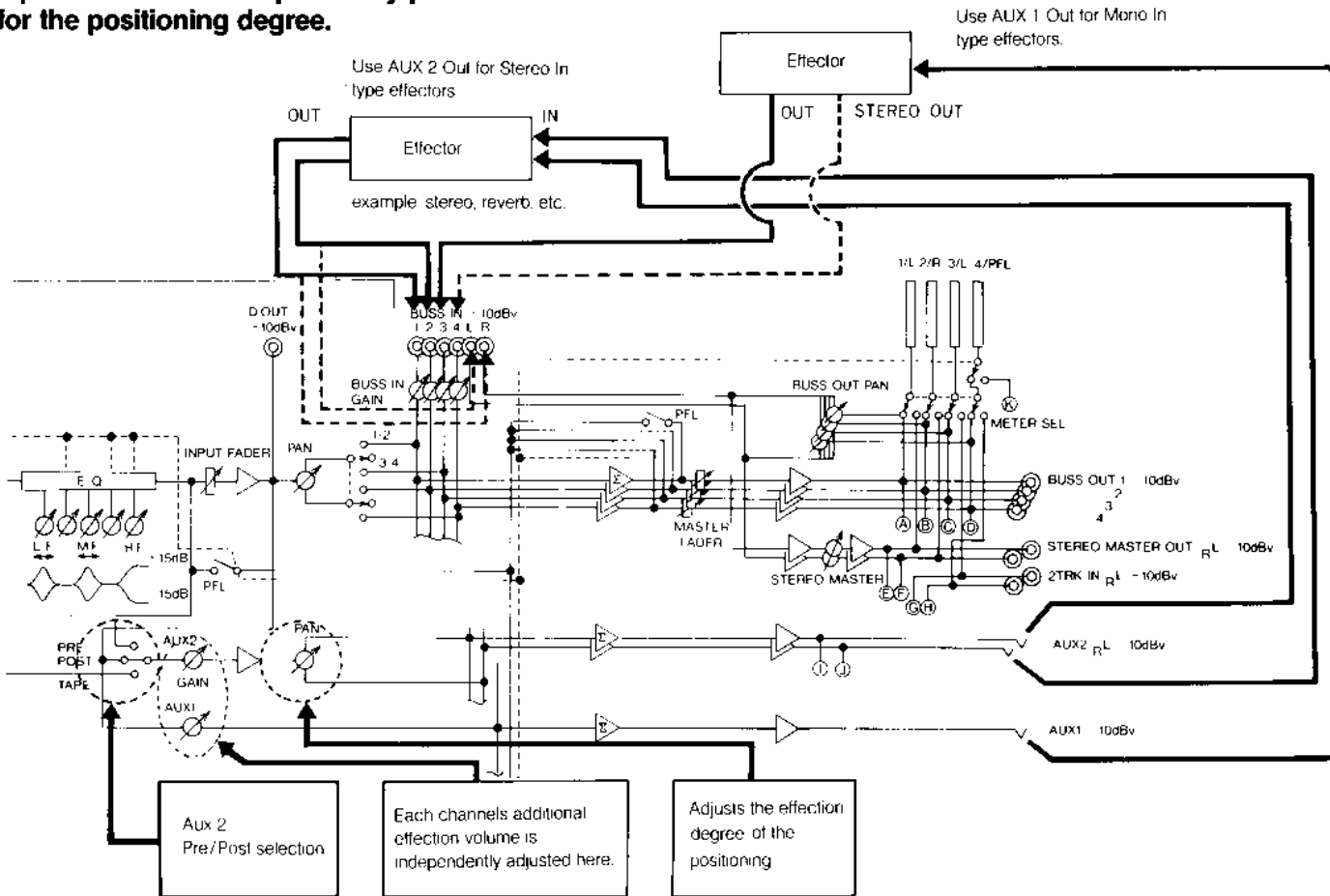

## About the Parametric Equalizer

This machine is equipped with a fixed frequency 10kHz shelving type equalizer and 2-band parametric equalizers which cover different frequencies provided at each input channel. The two parametric equalizers can be set at any

frequency within the ranges of 60 Hz to 1 kHz, and 400 Hz and 6 kHz. Furthermore it is possible to boost or cut in the +15 dB range, and will be highly effective in adding "character" to the sound by controlling the fundamental frequency and harmonic overtones which determine the timbre of musical instruments and the human voice.

**Note:** *Although the parametric equalizer is highly effective in correcting mistakes in the original sound, during microphone recording, it is important to change mic positioning or use another type of mic to obtain the desired timbre before relying on the equalizer.*

### Frequency Range of Various Musical Instruments

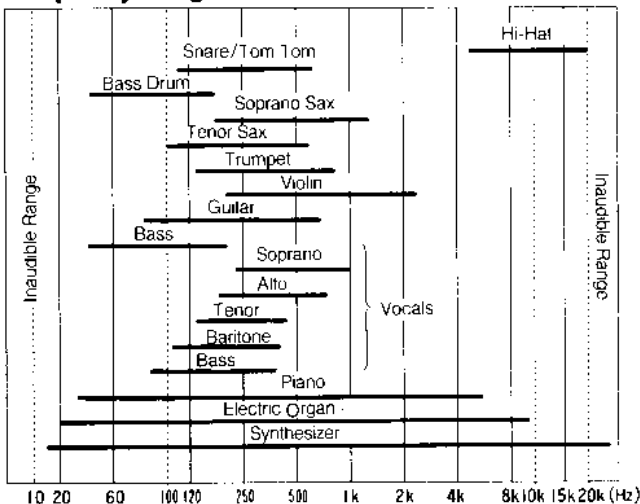

### Sound Source Equalizing Responses

Sound Source	Cut Point	Boost Point
Human Voice	Lip noise at 2 kHz Nasal at 1 kHz Popping p's below 80 Hz	Hot at 8 to 12 kHz Clarity at 3 kHz Body at 200 to 400 Hz
Piano	Tinny at 1 to 2 kHz Boomy bass at 320 Hz	Presence at 5 kHz Bass at 125 Hz
Electric Guitar	Muddy below 80 Hz	Clear at 3.2 kHz Bass at 125 Hz
Electric Bass	Tinny at 1 kHz Boomy bass at 125 Hz	Grunting at 620 Hz Low under 80 Hz
Snare Drum	Excess ringing at 1 kHz	Snappy over 2 kHz Full at 125 Hz Deep at 80 Hz
Bass Drum	Floppy at 620 Hz Excess bass under 80 Hz	Slap at 3.2 to 5 kHz Bass at 80 to 125 Hz

- Sound depth by controlling the frequency around 100 Hz
- Add character by controlling the frequency around 1 kHz
- Voluminous sound between 2 to 4 kHz
- Clarity around 6 kHz
- Brilliant sound over 8 kHz

## Other Uses

This system provides as a mixer of PA system, for small halls or live houses, by controlling a broad range of functions such as speaker sound reproduction, sending

to the stage monitors, and effect processing.

The example below shows: Mixes instruments' outputs with 4CHAN buss 1, 2 and sends them all to the main speakers from *BUSS OUT 1, 2* ⑳. *AUX 1 OUT* ⑲ is used to send to effectors and *AUX 2 OUT* ㉑ used to send to 2-channel stage monitors (*AUX 2 input selector* ④ set to PRE). Since the CD or cassette tape is played as the SE and BGM before a performance, those players are connected to the *TAPE IN* jack ㉒ to send to the main speakers when selecting *TAPE* by *Input selector* ②. Furthermore, we have added the 2016 line mixer to make it compatible as a sophisticated system.

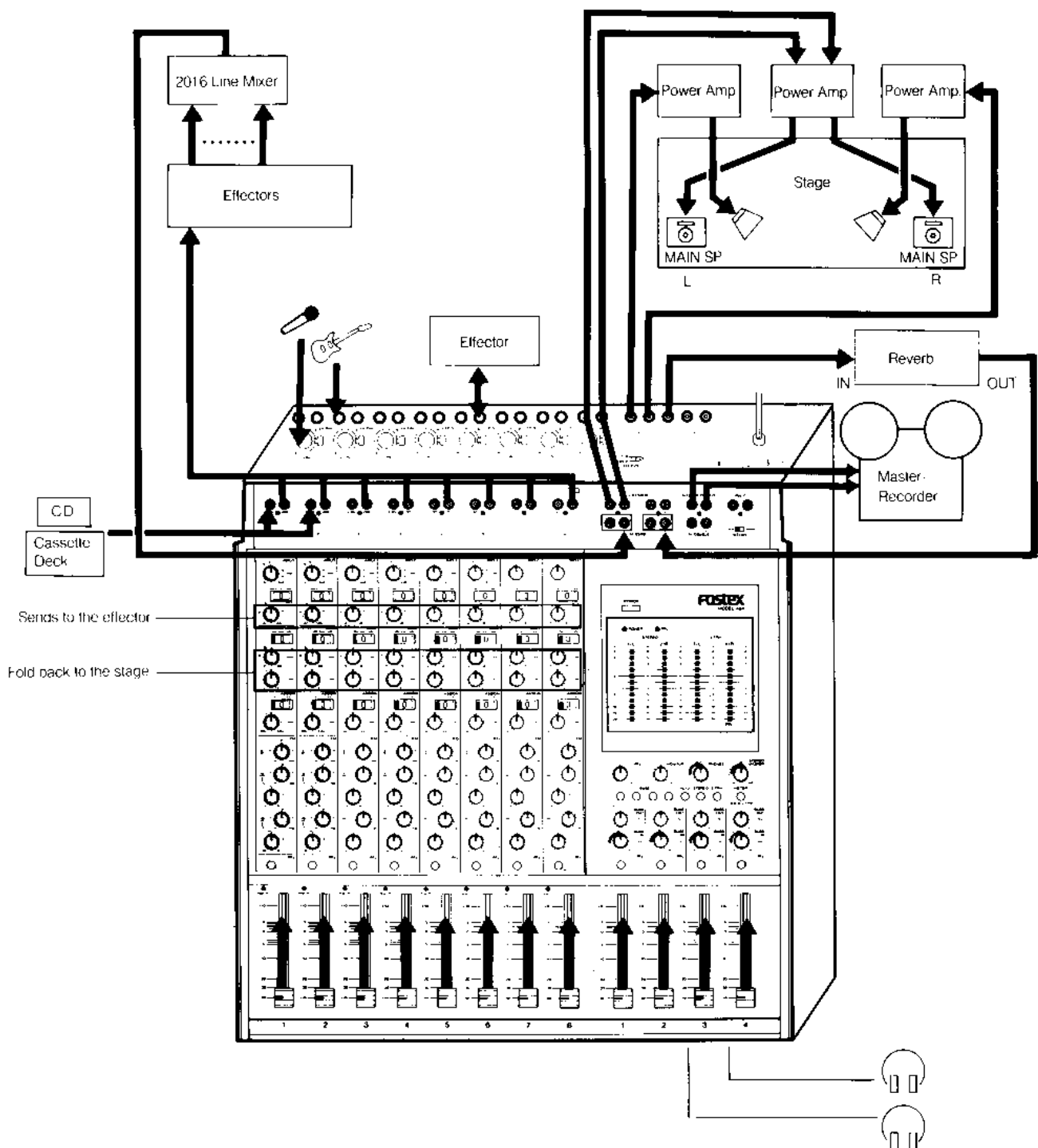

## Multitrack Recording

Model 454, when used in combination with multitrack

recorders such as Model R8, etc., acts as a control center of multitrack recording (the production method that records instrumental performance or SE/MC by part, then performs mix down at the final stage), and completely supports all processing stages (overdubbing, ping pong recording, mixdown, etc.) of multitrack recording.

A representative example of multitrack recording by a combination of the Model 454 and Model R8 is indicated in the following.

### Send to the effector

As shown in the figure, it is convenient to select the send/return to the effectors by preparing the the D. OUT jack ⑫ and AUX 1 to 2 OUT jack ⑬ and ⑭ then patching it in front of the 3010.

### Return from the effector

It is sent to the 4CHAN BUSS IN of the 454 after gathered by the 2016 line mixer.

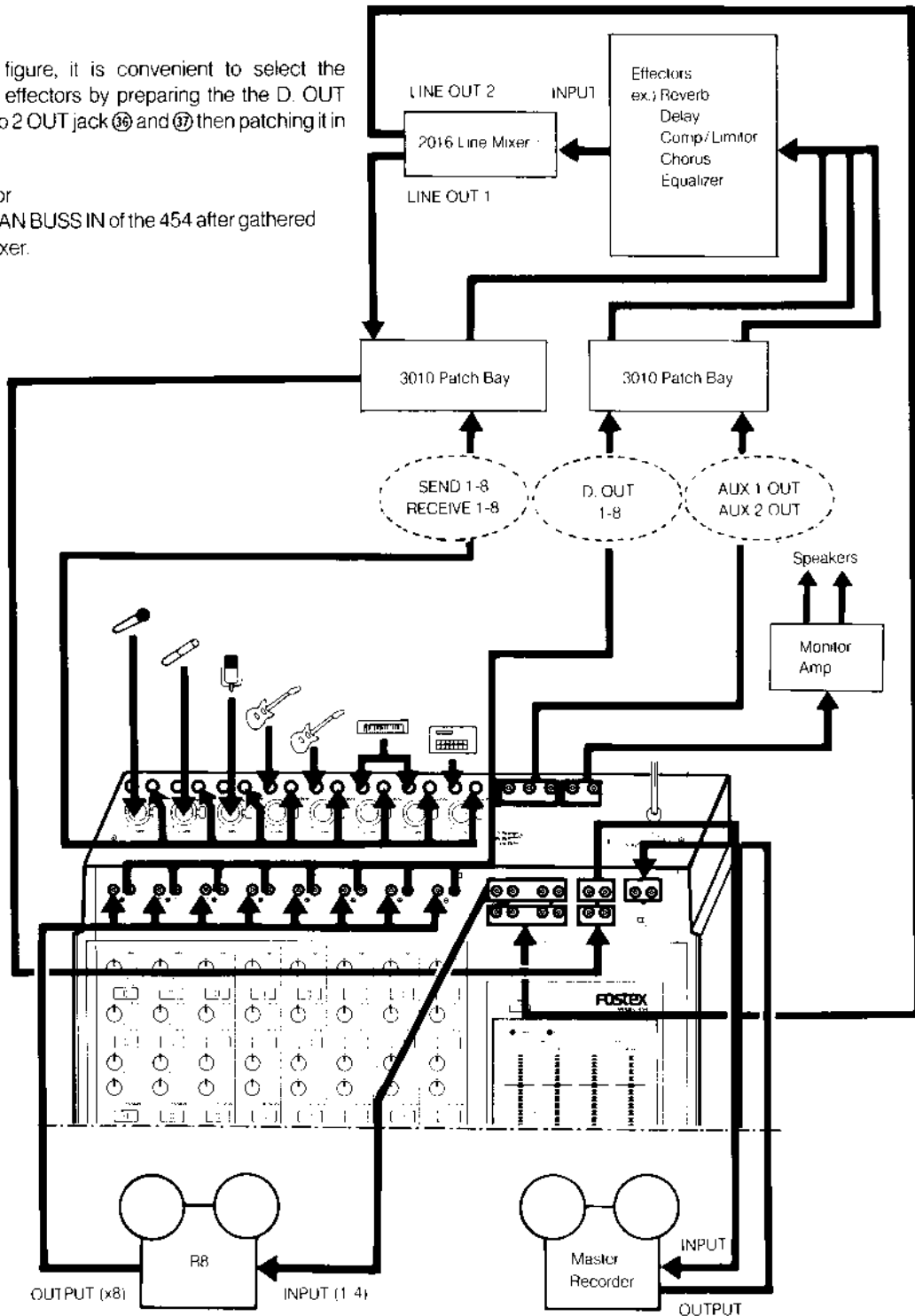

**Note:** The buss output of Model 454 is 4-channel. On the other hand, Model R8 multitrack recorder's input is 8-channel. But each of 4 INPUTs 5 to 8 of Model R8 has a connection switch connected parallel to INPUT 1 to 4. But when nothing is connected to 5 to 8, the same signal is each sent to the INPUTs 1 and 5, 2 and 6, 3 and 7, 4 and 8. Therefore it is possible to record the BUSS OUT

signals of Model 454 by connecting the *BUSS OUT jack 1 to 4* ⑮ directly to Model R8 INPUT 1 to 4 and selecting by the safe/ready button (record track selector).

But when you want to simultaneously record separate signals on more than 5 tracks, it is advisable to use the *D. OUT jack* ⑯.

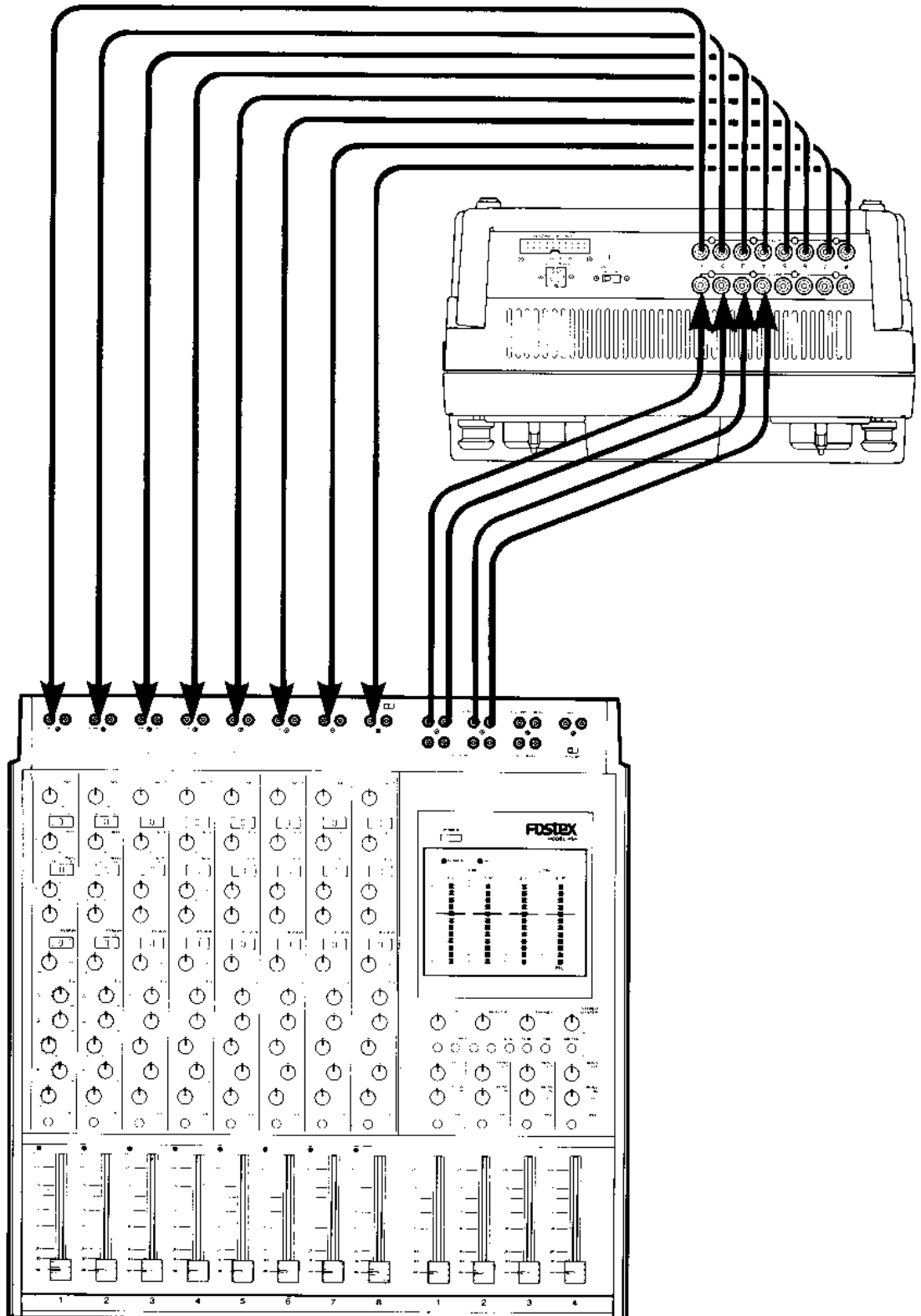

# I. Basic Track Recording

## What is Basic Track Recording?

The multitrack recording performs the "rhythm section" recordings first. The "rhythm section" usually refers to the drums, percussions, bass, side work (coding) guitars, keyboards, etc. and provides the outline part to make a performance. The "basic track recording" mentioned here refers to this "rhythm section" recordings.

Look at figure 1. This example indicates simultaneous separate recordings on 4 separate tracks. The drums, electric bass, and electric guitar recorded with a multi-microphone, is simultaneously recorded on Model R8's tracks 1 to 4. After making the level and sound adjustments for each level (refer to page 9, "2. About the Level Adjustments With the External Equipment" and page 11, "About the Parametric Equalizer"), then make the settings for sending to the Model R8. The track plan is as follows.

### Model R8 Track Chart

TRK	1	2	3	4
SOURCE	L ← → R		EB	EG
	DRUMS		electric	electric
	Kick (bass drum)		bass	guitar
	SD (snare drum)			
	TOM (tom tom)			
	Crash (cymbals)			
	etc.			

### <Explanation 1> How to send various sources to various tracks

**TRK 1 & 2:** Model 454's *BUSS OUT jack 1 & 2* ⑪ signals (the drums sound recorded with 4 microphones then positioned by stereo mixing) are sent to TRK 1 & 2. First of all, the B. D. and S. D. connected to the *INPUT faders* ⑫ of channel 1 & 2 is sent to the 4CHAN Buss 1 & 2 in the center position. (choose *ASSIGN switch* ⑦ to 1 — 2, and *PAN* ⑧ set to ⑥ for both channels). Next, the OVERTOP (TOM and cymbals) connected to *INPUT faders* of channels 3 & 4 is sent to 4CHAN Buss 1 & 2 in the stereo position. (choose *ASSIGN switch* ⑦ to 1 — 2 for both channels, for channel 3 *PAN* ⑧ set to ⑥, and for channel 4 *PAN* ⑧ set to ⑤).

Furthermore, to determine the level of these stereo-positioned 4CHAN BUSS signal 1 & 2 and send to the *BUSS OUT jack 1 and 2* ⑪, the *4CH BUSS MASTER fader 1 and 2* ⑬ must be adjusted (it can be verified with 1 and 2 of *Meter* ⑲).

**TRK 3:** This machine's *BUSS OUT jack 3* ⑪ signal (E. B. Sound) is sent to the TRK 3. The E. B. connected to the channel 5 *INPUT fader* ⑫ is sent to the 4CHAN Buss 3 (choose *ASSIGN switch* ⑦ to 3 — 4, *PAN* ⑧ set to ⑥). Then the *4CH BUSS MASTER fader 3* ⑬ determines the send level (can be verified with the 3 of *Meter* ⑲).

**TRK 4:** This machine's *BUSS OUT jack 4* ⑪ signal (E. G. Sound) is sent to the TRK 4. Follow the procedures in TRK 3 (choose *ASSIGN switch* ⑦ to 3 — 4, *PAN* ⑧ set to ⑤).

As shown in this example, with the combination of the *ASSIGN switch* ⑦ and *PAN* ⑧, you can freely send a maximum of 8 inputs between 1 and 8 (we are using 6 inputs here) to the 4 BUSS OUT jacks. Refer to the Model R8 owner's manual for further information concerning recording track selection and other functions.

### <Explanation 2> How to Monitor

The monitoring method can largely be categorized into 2 methods.

**Method 1: to listen to the sound sent to the recorder.**

**Method 2: to listen to the sound returning from the recorder output.**

The example illustrated in figure 1 is sending to the monitor by method 2, but let's start with the explanation for method 1.

**[Method 1]** It is performed by selecting BUSS 1, 2, 3, or 4 of the *Monitor selector* ⑰. The BUSS 1, 3 is positioned to MONITOR OUT L and the BUSS 2, 4 is positioned to the R. (For more information refer to P. 6 of the "Monitor Selector" ⑰).

What's more, by selecting the *PFL button* ⑩ or ⑪, the signals not passing the *INPUT fader* ⑫ of various channels or the various *4CH BUSS MASTER fader* ⑬ can be monitored with center positioning (but by setting the *INPUT fader* ⑫ and *4CH BUSS MASTER fader* ⑬, the balance among various sources and the balance sent to the actual recording may be different).

Furthermore, by selecting the STEREO of *Monitor selector* ⑰ the output signals of the 4CHAN Buss 1 to 4 can be monitored as a 2 channel (STEREO L/R) signal. In such case, by adjusting the *BUSS OUT PAN pot* ⑯ and *STEREO MASTER level knob* ⑳ etc., the assumed positioning and volume can be monitored during mix down. For this example, it is advisable to adjust the positioning for the E. B. and E. G. (also in this case the various sources' volume balance and the actual balance sent to the recorder may be different, so be careful).

**[Method 2]** To monitor the recorder output, use the *AUX 2 section* ④, ⑤ and ⑥. With this method, desirable volume and positioning can be monitored regardless of the recording level of each track. Therefore it is extremely convenient when compared to the previously mentioned method.

The signal input to the track on recording can be



monitored as it will always be output from R8 (= input monitor). What's more by using the record track select function, the selected track can output as an input monitor and the others as a tape monitor (= tape sound SYNC play), regardless of recording or not. In either case, the example figure 1 illustrates TRK 1 to 4 output signal mixed with the *AUX 2* section ④, ⑤, and ⑥ of the 4-channel 1 to 4. First of all, press the *AUX 2* of the *Monitor selector* ⑰ to listen to the sound of the *AUX 2* Buss. Next, since Model R8's TRK 1 to 4 is connected to 1 to 4 of the *TAPE IN* jack ⑳, set the *AUX 2 selector* ④ of the connected track that you want to monitor to the *TAPE* position. By doing this, the *AUX 2 level knob* ⑤ adjusts the volume and the *AUX 2 PAN pot* ⑥ adjusts the left/right position, thus, allowing for monitoring. Similarly it is advisable to make settings by assuming the positioning during mix down (when monitoring the monitor speaker,

turn up the *MONITOR level knob* ㉔ and when monitoring the headphones, turn up the *PHONES level knob* ㉕).

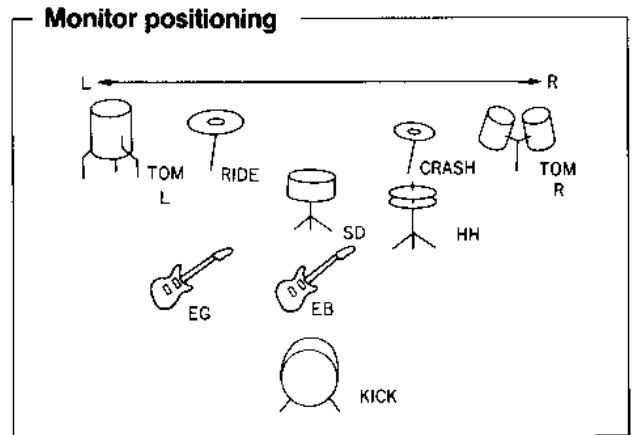

**Figure 1 Basic Track Recording**

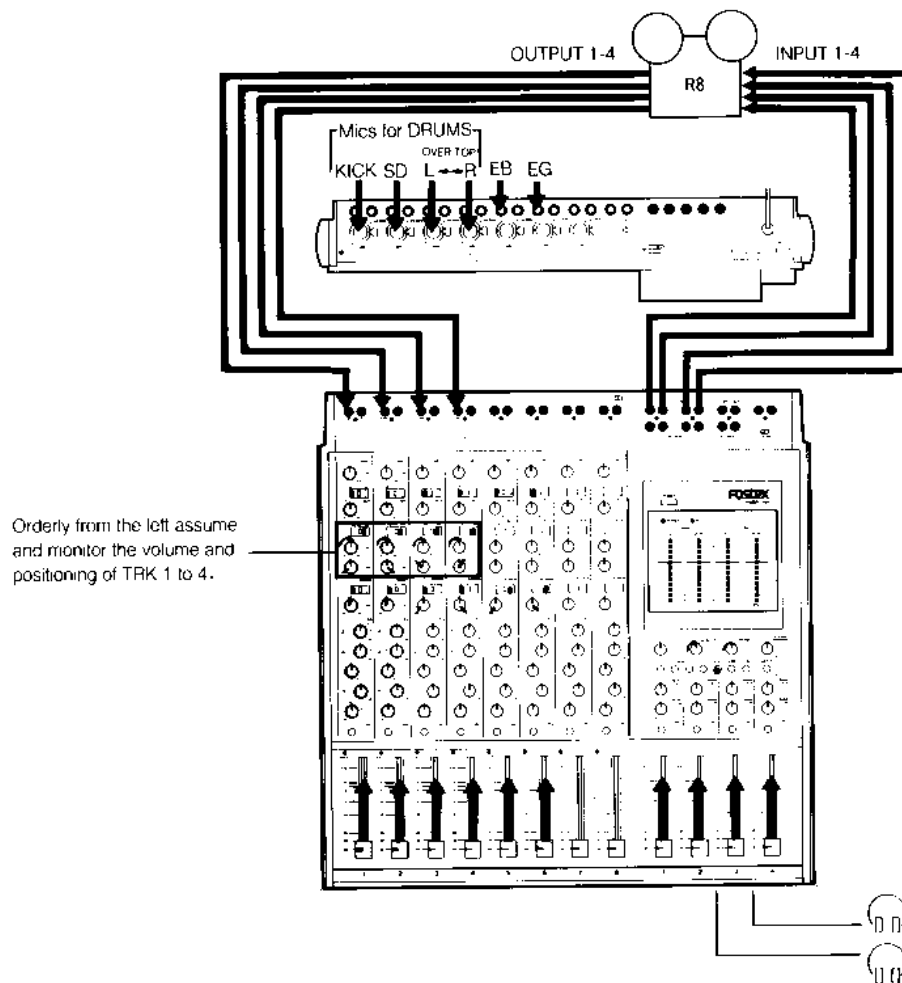

**When wanting to record by assuming the sound processing**

The example in figure 1 indicates the dry sound (the raw sound without the effected sound), but there are times when you may want to record by assuming the effect processing during mix down (send the effected sound solely to the monitor channel and not to the tape). For example, when you want to monitor the SD, etc. with reverb, observe the following (refer to figure 2).

**1. The monitor output from the AUX 2 OUT is sent to**

the reverb machine (the level and the left/right positioning of the signal to the reverb machine can be adjusted with the **AUX 2 level knob** ⑤ and the **AUX 2 PAN** ⑥).

**2. The reverb output is returned to the STEREO IN jack** ⑫ (the left/right positioning can be adjusted with the **BUSS OUT PAN** ⑮ when the 4CHAN Buss signal <dry sound> is mixed). The total volume of the monitor (dry + effected sound) is adjusted with the **STEREO MASTER level knob** ⑳ and is monitored by selecting the **Monitor selector** ㉑.

**Figure 2 Assuming Sound Processing**

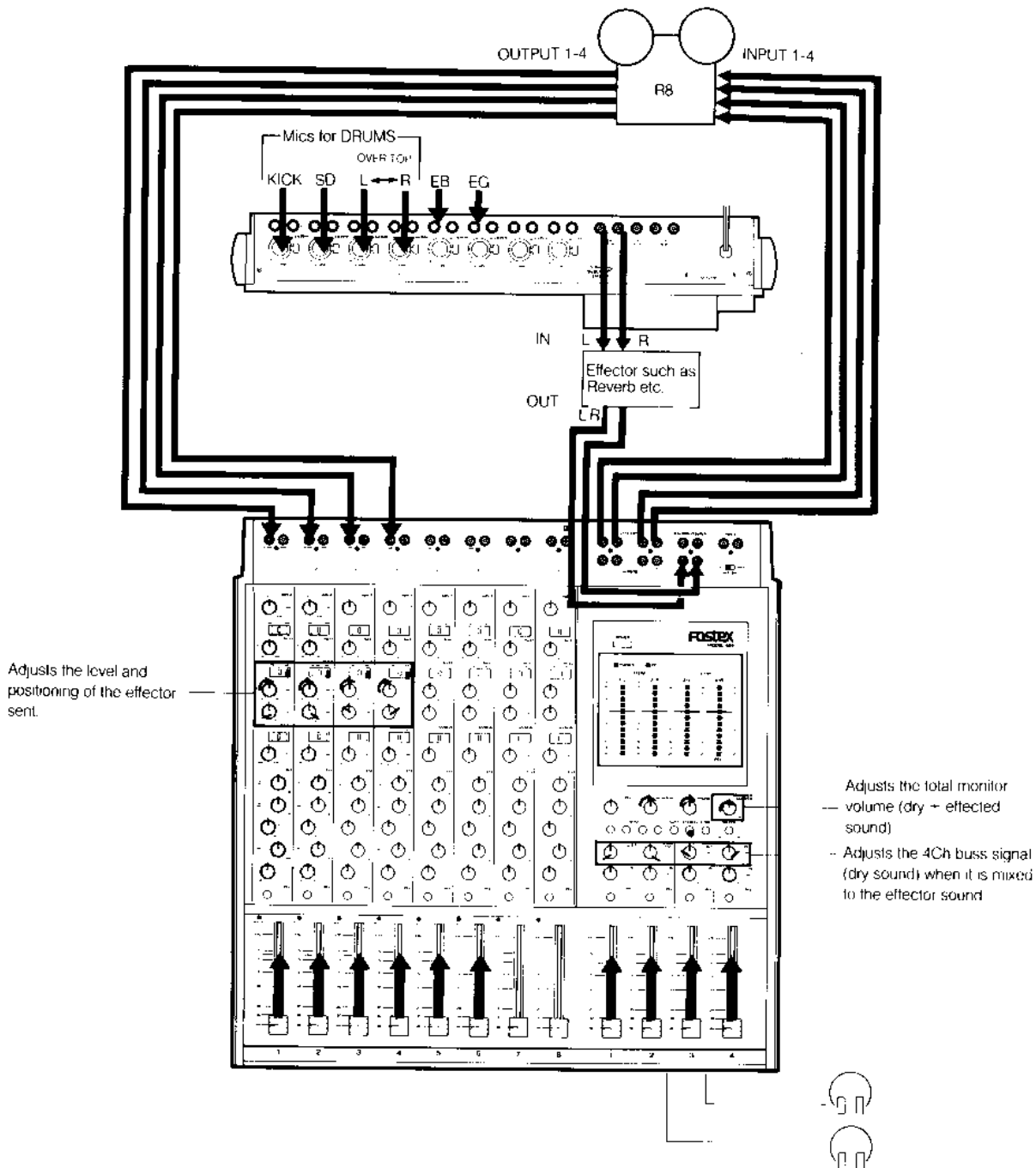

## II. Overdubbing

What is Overdubbing?

Overdubbing is to monitor the recorded track with the sync. play (played with the recording head) and record on a different track with other sources (synthesizer, vocal, etc.).

Look at figure 3. This example indicates the sync play monitoring of the recorded TRK 1 to 4, then overdubbing TRK 5 to synthesizer 1 (SYN 1), and TRK 6 to synthesizer 2 (SYN 2). (refer to the owner's manual for the functions such as the record track selection, etc.).

First of all, connect the new recording source to *INPUT jack* ⑫ and ⑬ (this example is for 5, 6 channel), then set the *INPUT selector* ② to the INPUT. Then, by using the *ASSIGN switch* ⑦ and *PAN pot* ⑧, the sources initiated by the *INPUT fader* ⑫ is sent to the buss connected to the recording track. (This example

illustrates: SYN 1 to 4CHAN Buss 1 to TRK 5, and SYN 2 to 4CHAN Buss 2 to TRK 6). Furthermore, the master fader of the corresponding buss (the *4CH BUSS MASTER fader 1 and 2* ⑬ in this case) adjusts the send level to the recorder, and this is verified with *Meter* ⑭.

The sync-played tape sounds and the new source to be recorded can be monitored by the *AUX 2 section* ④, ⑤, and ⑥ with the monitor method [method 2] on P. 15 The volume and positioning of each track can freely be adjusted (the recording level isn't affected). In this example, the *AUX 2 selector* ④ of channel 1 to 6 is set to the TAPE, and the *AUX 2 level knob* ⑤ and *AUX 2 PAN* ⑥ can be adjusted for monitoring (*MONITOR selector* ⑰ to AUX 2).

Furthermore, when you want to directly monitor the output of the new recording source from the BUSS OUT, select the corresponding buss's Monitor selector, then monitor when it is mixed with the tape monitor of the AUX 2 section (in this case, the SYN 1 is positioned in the L and the SYN 2 is positioned in the R).

**Figure 3 Overdubbing**

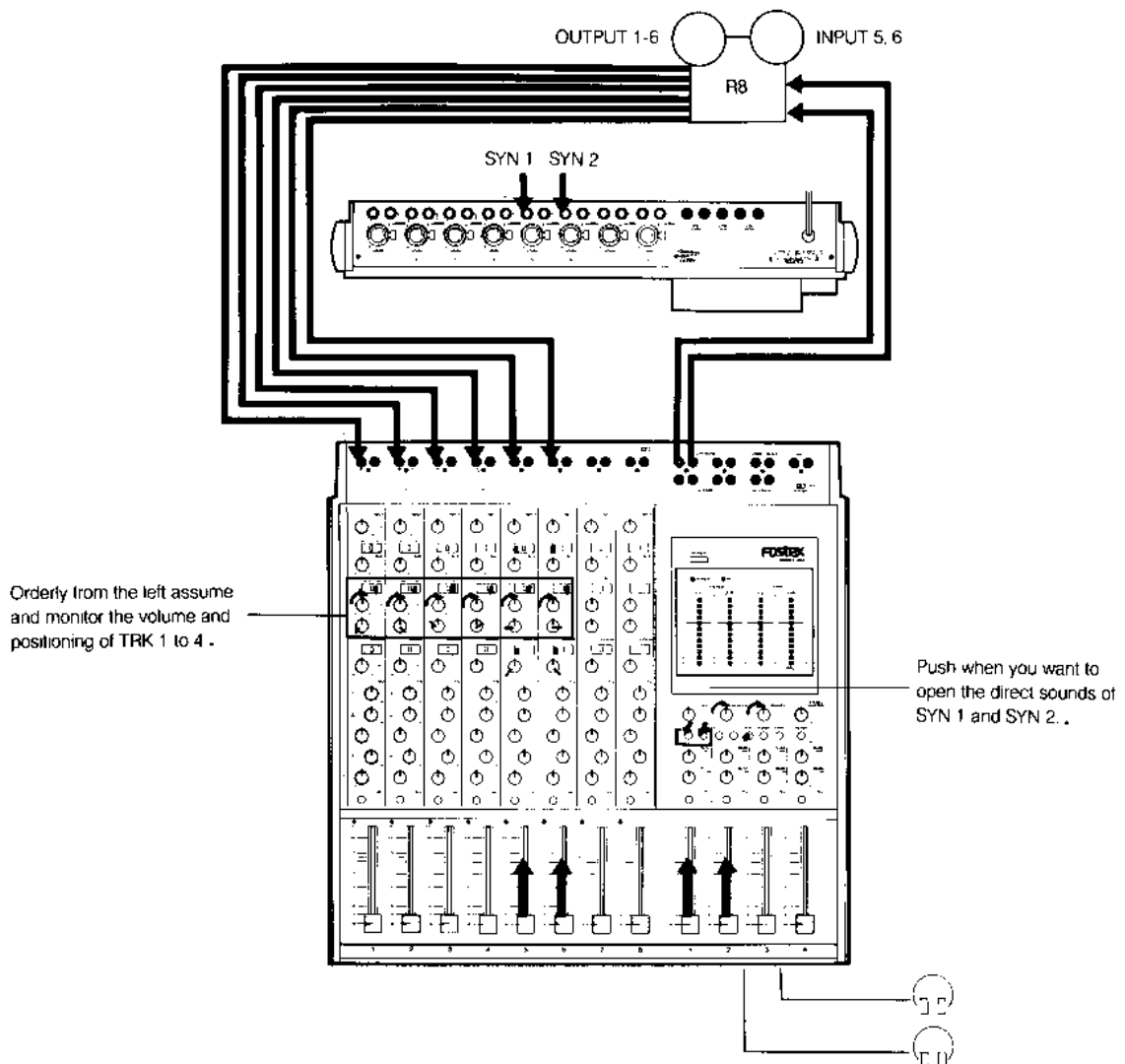

### III. Ping Pong Recording

What is Ping Pong Recording?

Ping pong recording is to gather the sounds on already-recorded tracks in the mixer playing them back and record the mixed signal(s) on different track(s). By performing the ping pong recording, it is possible to overdub a new sound source on the former track, thus, making it convenient when you want to record various sound sources on limited tracks.

Look at figure 4. In this example, Model R8's output signal of TRK 1 to 4 (the previous basic track) is stereo mixed with this machine, then ping pong recorded to TRK 7 and 8. The 4CH BUSS OUT was used (refer to figure 1 and figure 3) up to the overdubbing stage, but this illustrates the method of using the STEREO MASTER OUT. Of course the 4CH BUSS OUT can be used, but since the return signals input to the STEREO IN L, R from effectors can be mixed with the STEREO MASTER OUT, this method is so useful when performing ping pong recording. This is because once it is recorded by ping pong recording, the mixed sources can't be processed separately during mix down. In such case, you cannot but add the same effect to each of the entire sources mixed in TRK 7 and TRK 8. Therefore, it is better to send the

effect sound to the recording track, which are through the necessary effect processes during ping pong recording. This is why it is convenient to use the STEREO MASTER OUT with inputs that can mix more than one return from the effector.

First of all as shown in figure 4, start up the TRK 1 to 4 output signal to channel 1 to 4 of the *INPUT fader* ⑩ (*INPUT selector* ② to TAPE). Then by using the *ASSIGN switch* ⑦ and the *PAN* ⑧, send these signals to the 4CH BUSS 1 to 4, then send it to TRK 7 and 8 from the *STEREO MASTER OUT jack* ⑬ after it passes through the *BUSS OUT PAN* ⑯ and the *STEREO MASTER level knob* ⑳. You can choose to either select the *Monitor selector* ⑰ STEREO the listen to the signal sent to the recorder or send the output signal of TRK 7 and 8 to the 2 *TRK IN jack* ⑳, then select the 2 TRK of the *Monitor selector* ⑰ and listen to the recorder output. Use the *D. OUT jack* ㉑ or the *AUX 2 OUT jack* ㉒ to process the effects. Figure 4 illustrates the connection of the effector return to the *BUSS IN jack 1 to 4* ㉓ from the *D. OUT jack* ㉑, and the adjustment of the effection volume by the *BUSS IN gain knob 1 to 4* ㉔ then sent to the 4CH BUSS 1 to 4 (in this case each channel is independently processed with a effector). Furthermore, the effector return from the *AUX 2 OUT jack* ㉒ is connected to the *STEREO IN jack* ㉕, then mixed with the signals from the 4CH BUSS and sent to the STEREO MASTER OUT.

Figure 4 Ping Pong Recording

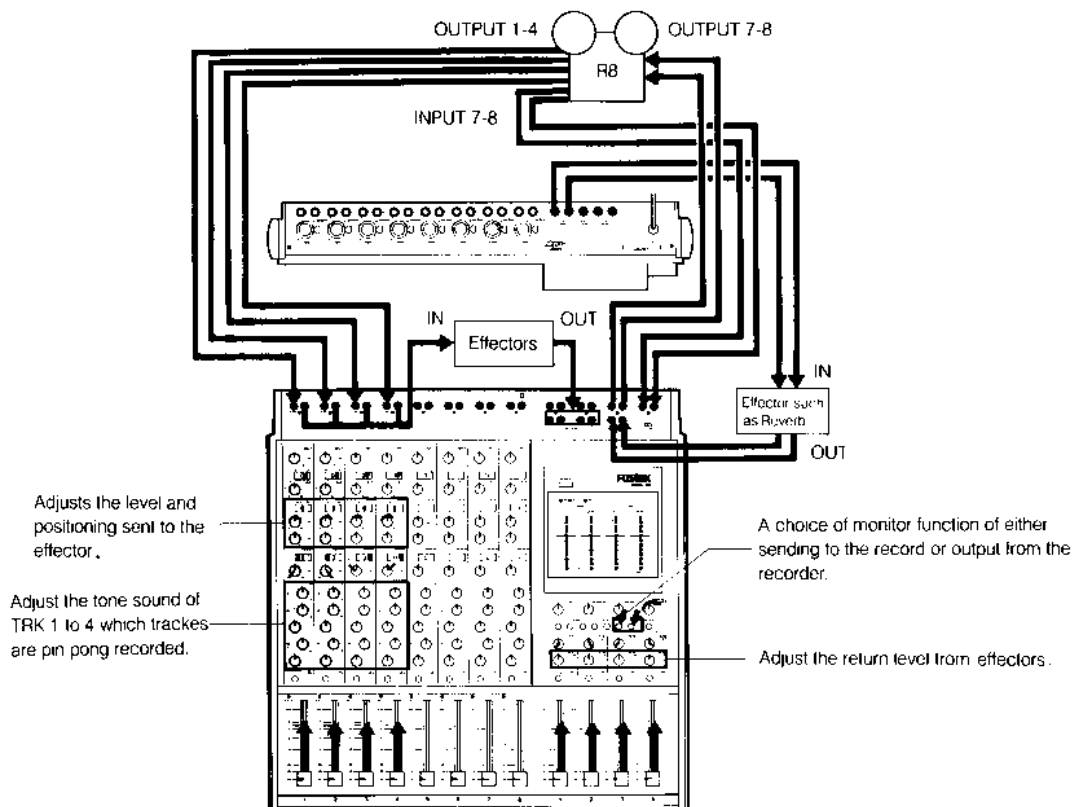

## IV. Mixdown

What is mixdown?

After finishing all recording on the multitrack recorder, then combining the playback sound of all tracks thru the mixer into stereo (or monaural), and copying it onto a master tape is called "mixdown." This is an important operation in which the final touches are made to the multitrack recording, and is carried out in parallel, from equalization to effect processing, for total sound creation.

Refer to figure 5. This is an example of applying various effects on the playback sound from the Model R8's TRK 1 to 8 mixed into stereo, then sending it to the master recorder along with the dry sound to mix down. Each track can be classified into two types according to the sources signals which are combined in the stereo of

each 4CHAN buss 1 & 2, 3 & 4 (is mixed to the 4CHAN buss 1 to 4 by using the *INPUT selector of channel 1 to 8* ② to TAPE, *ASSIGN switch* ⑦, and *PAN* ⑧). Furthermore, the buss 1 & 2, 3 & 4 is output from the *STEREO MASTER OUT jack* ⑬ after passing the *STEREO MASTER level knob* ⑫, by using the *4CH BUSS master fader* ⑬ and *BUSS OUT PAN* ⑯. Press the *PFL button* ⑩ and ⑭ to easily monitor while equalizing each track. It is also possible to monitor the buss 1 & 2, 3 & 4 mix signal by selecting the BUSS of the *Monitor selector* ⑰.

The effect processing method is almost the same as with the ping pong recording in that it uses the *D. OUT jack* ⑳, *AUX 1 OUT jack* ㉑ (monaural), *AUX 2 OUT jack* ㉒ (stereo) etc. to send to the effector, and the *BUSS IN jack 1 to 4* ㉓ and *STEREO IN jack* ㉔ are used to input the effector return. (for more information refer to P. 19 "Ping Pong Recording" and P. 9 "About the Connection with the Effector").

Figure 5 Mixdown

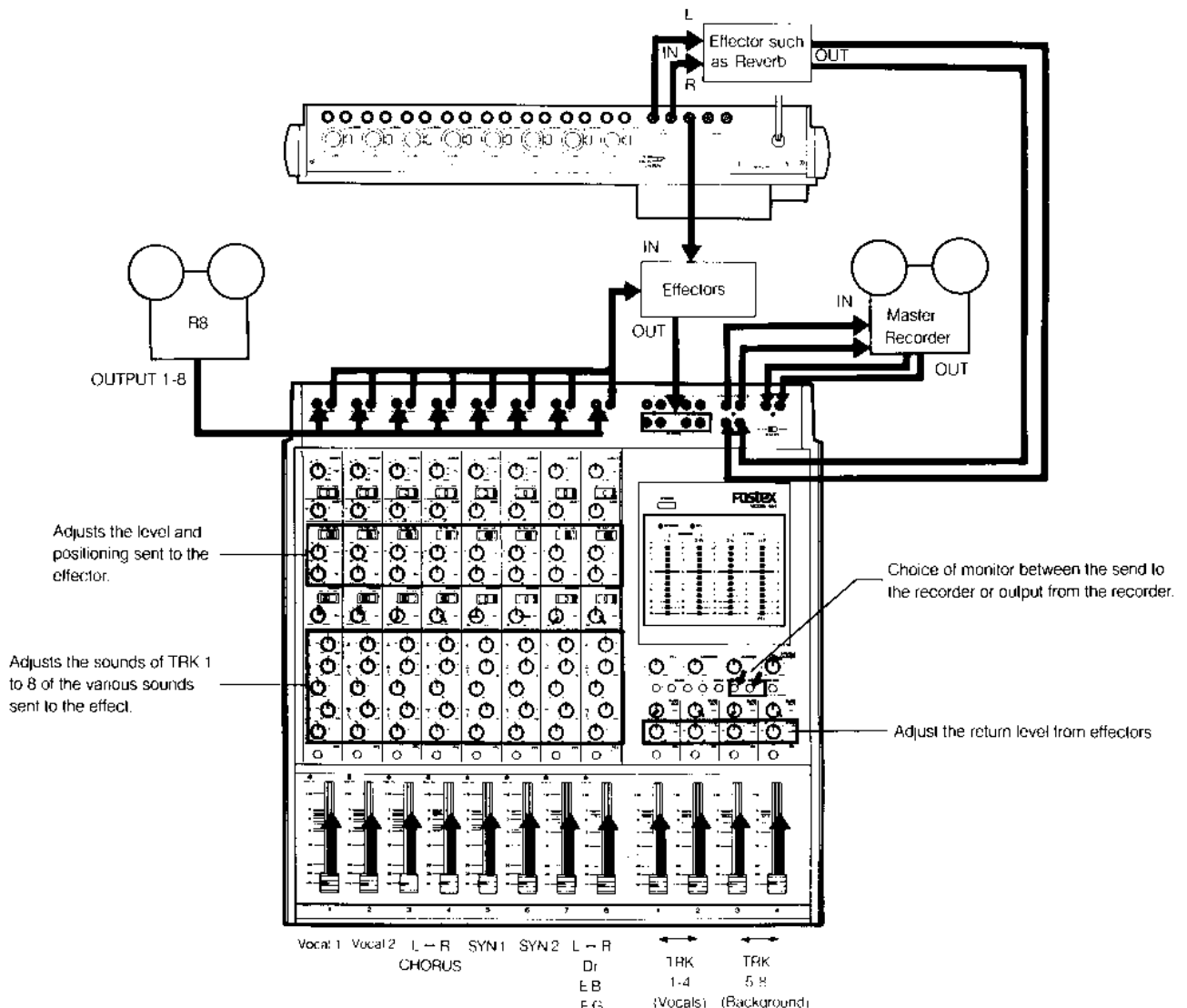

## Synchronized Mixdown with MIDI, etc.

By recording the SMPTE time code or FSK tape sync. signal in the multitrack recorder, the playback signals can be used to simultaneously perform the MIDI sequencer and drum machine.

Since the MIDI sequencer automatically performs simultaneously during live tape performance, the synthesizer and drum machine don't have to be recorded on the tape, thus, allowing to keep the finished track free. This requires multi-channel inputs in the mixer (track output variety + MIDI sound source output variety). To perform such tape sync. mix down by solely using this machine, use the AUX 2 section as a mixer. In such case it is compatible up to a maximum of 16 inputs.

Refer to figure 6. This example illustrates the playback sound of Model R8's TRK 1 to 7 (TRK 8 is used for the sync. signal), and the synchronized MIDI instrument output is sent to 4CHAN Buss, then mixed and output from the STEREO MASTER OUT and sent to the master

recorder.

First of all the TRK 1 to 7 output is connected to the *TAPE IN* jack ⑭ of this machine and output from the *AUX 2 OUT* after passing the *AUX 2* section ④, ⑤ and ⑥ (the sync. signal of TRK 8 is sent to the interface and drum machine). The tape playback signal from the *AUX 2 OUT* jack ⑰ is input from the *BUSS IN* jack 1 & 2 to the 4CHAN buss 1 & 2. Furthermore, the synchronized MIDI instrument outputs are mixed to 4CHAN buss 3 & 4 after passing the *INPUT* jack ⑳, *INPUT* fader ㉑, *ASSIGN* switch ㉒, *PAN* ㉓ of each channel. Buss 1 & 2 (tape playback sound) and buss 3 & 4 (instrument sound) is mixed to the *STEREO L/R* by *4CH BUSS MASTER* fader ㉔ and *BUSS OUT PAN* ㉕, then output from the *STEREO MASTER OUT*. Concerning the monitor and effect processing, follow the procedures on P. 20 "Mixdown." But in this case you must consider the effect processing because the *EQ* ㉖ is effective only with the input signal (instrument sound) from *INPUT* jack ⑳ and doesn't effect the input signal (tape playback sound) from the *TAPE IN* jack ⑭.

Figure 6

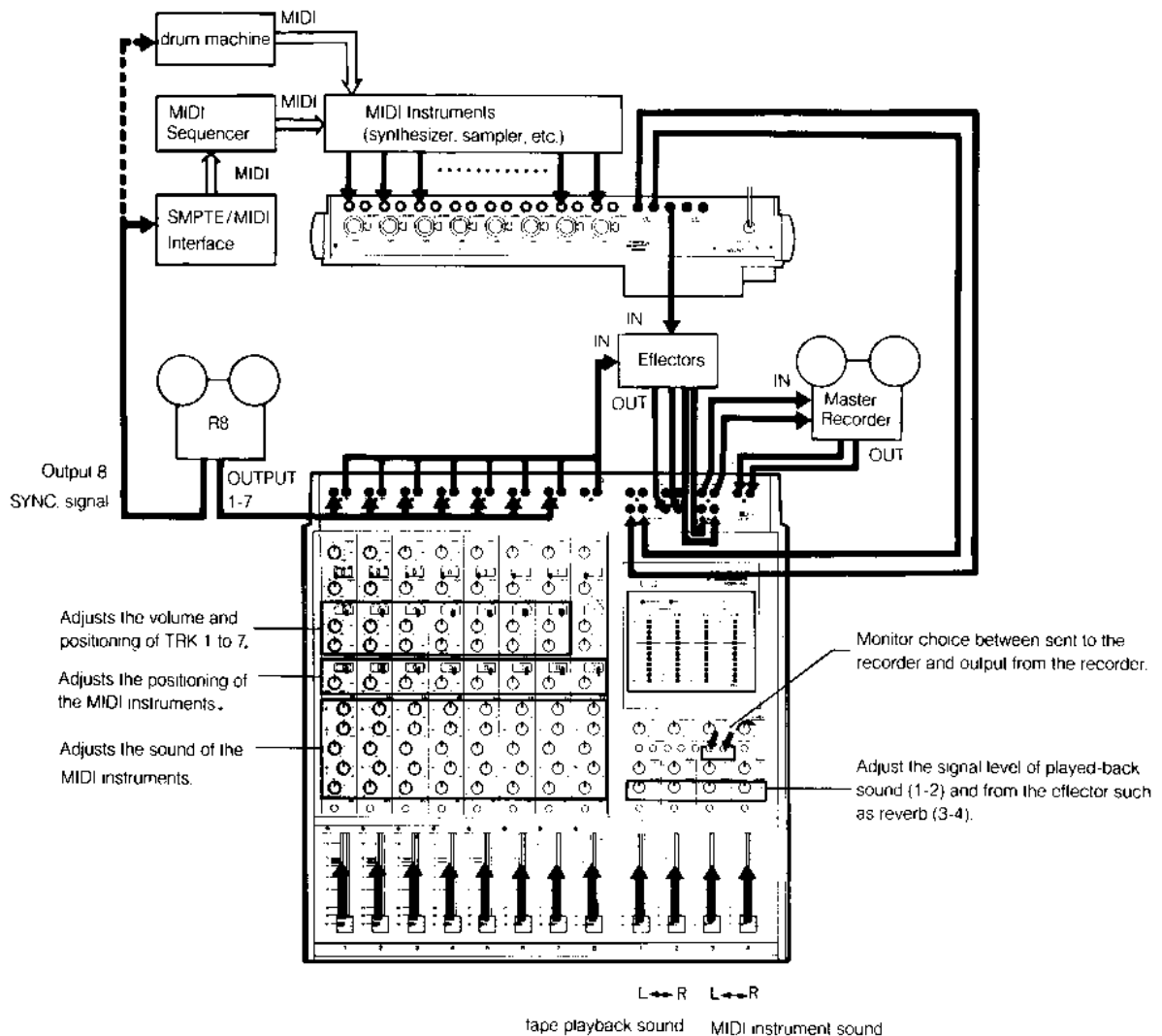

## Trouble Shooting (Before thinking, "is it broken?")

When this machines doesn't operate properly, please verify the following points before thinking it needs to be repaired.

- **The input signal doesn't take effect in *INPUT fader* ⑫.**
  - Check to see that the input selector is properly chosen.
  - Check to see that a monaural phone plug isn't connected to the channel's *INSERT jack* ⑳. If so, signals will be sent to the effector but there will be no return from the effector output.
- **Can't hear the output selected by the *MONITOR selector* ⑰. And the *Meter* ㉓ doesn't display properly.**
  - Check to see if the *PFL button* ⑩ or ⑭ is selected. Please refer to P. 5 "Description and Function of Various Parts/Operation Procedures."
- ***PFL button* ⑩ and ⑭ are selected but can't monitor. And the *Meter* ㉓ doesn't display properly.**
  - Is the *PFL level knob* ⑲ turned up? If the *MONITOR level knob* ㉑ and *PHONES level knob* ㉒ turned up? Please check again.
- **The channel effection isn't erased even after fading out with the *INPUT fader* ⑫.**
  - Check to see if the *AUX 2 section* ④, ⑤ and ⑥ is used to send to the effector and if the *AUX 2 selector* ④ is set at the PRE or TAPE position. When you want to use in combination with the fader, set to the POST position.
- **The level was adjusted to the *TRIM 1* but the *PEAK/PFL LED* ① illuminates.**
  - Did you raise the gain of the *EQ* ⑨ to adjust the sound after settling the level? Refer to P. 9 "About the level adjustments with external equipment" again.
- **Howling occurs when using the track with a recorder as an input monitor.**
  - Is that track output connected to the buss used to send to that track? Check the choice of the *INPUT selector* ② and the *AUX 2 selector* ④.

**Fostex**

**FOSTEX CORPORATION** 3-2-35 Musashino, Akishima-shi, Tokyo, Japan 196

**FOSTEX CORPORATION OF AMERICA** 15431, Blackburn Ave., Norwalk, CA 90650, U.S.A.