

# Owner's Manual

## Model

# 450

## RECORDING MIXER

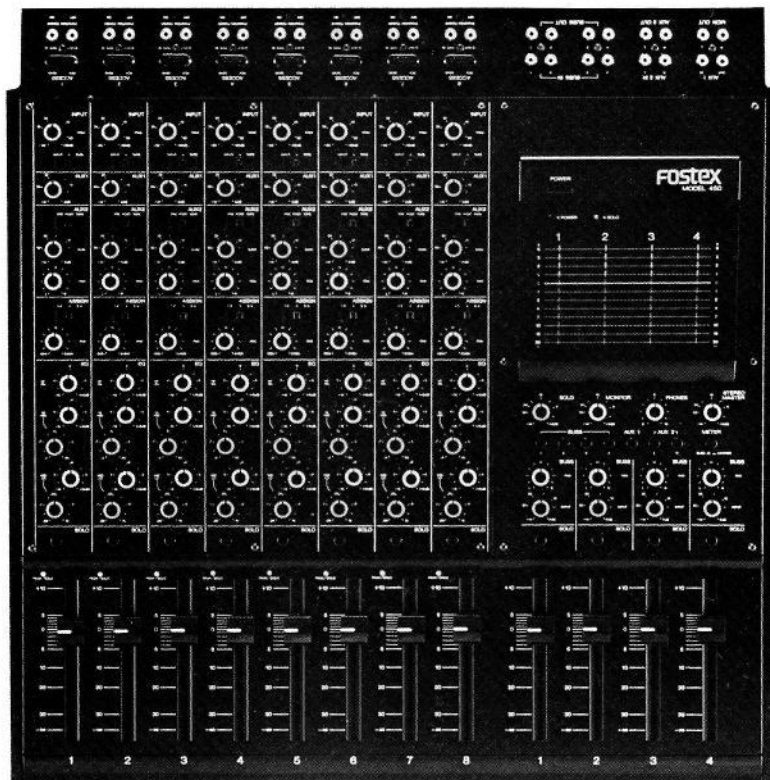

# Fostex®

<b>TABLE OF CONTENTS</b>			<b>PAGE</b>
<b>SECTION 1</b>	Feature Descriptions		2
<b>SECTION 2</b>	Introduction		4
<b>SECTION 3</b>	Interconnections & Installation		4
<b>SECTION 4</b>	External Effects & Processing		5
<b>SECTION 5</b>	Using the Parametric Equalizer		6
<b>SECTION 6</b>	Multitrack Applications		7
<b>SECTION 7</b>	P.A. Applications		10
<b>SECTION 8</b>	Maintenance		12
<b>SECTION 9</b>	Block Diagram		13
<b>SECTION 10</b>	Specifications		14
<b>SECTION 11</b>	Bibliography		14
	Safety Instructions		

**WARNING: To avoid possible electric shock hazard,  
do not expose this appliance to rain or moisture.  
There are no user-serviceable parts inside.  
Refer servicing to qualified service personnel.**

**HOUSEHOLD USE ONLY**

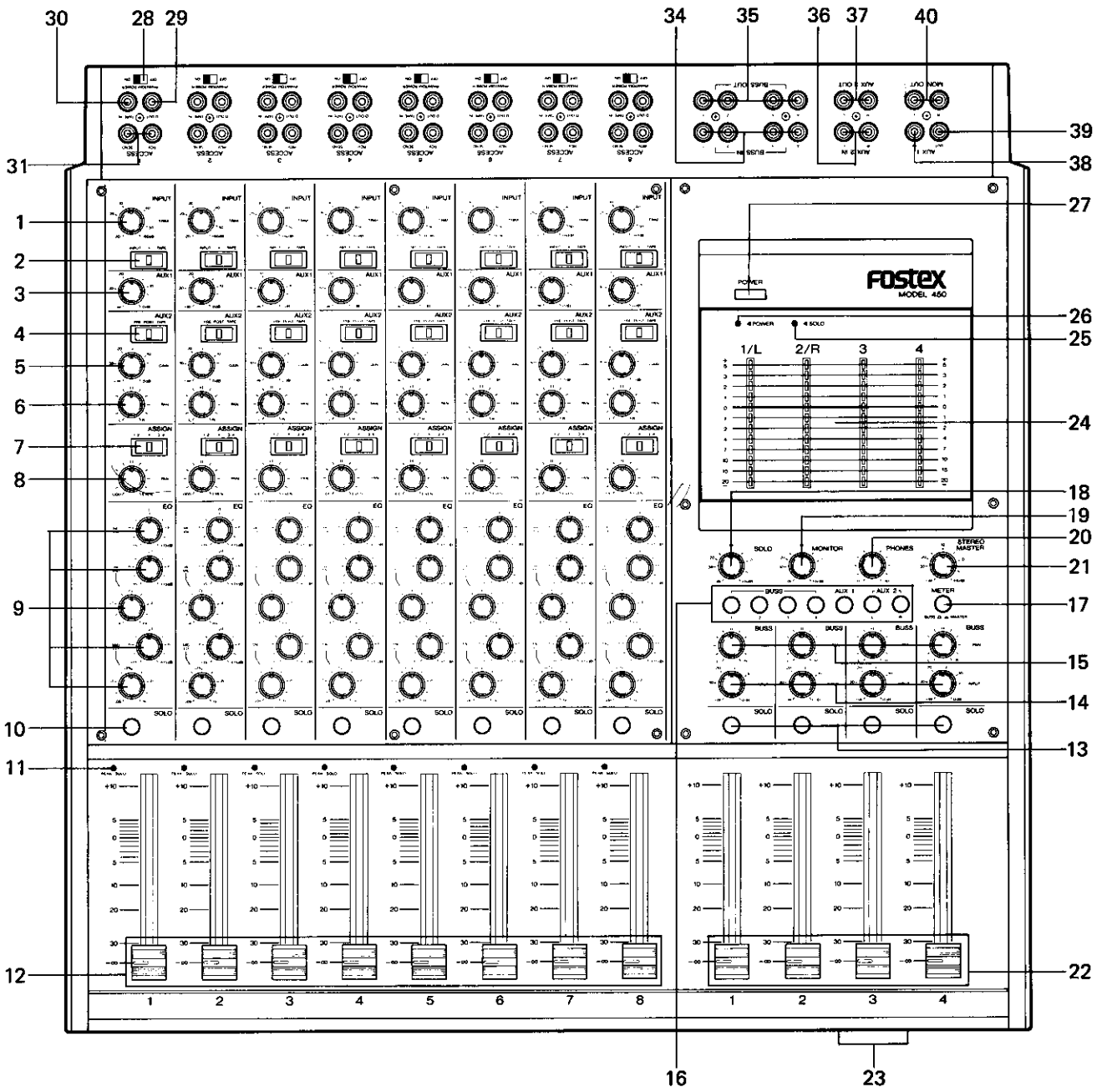
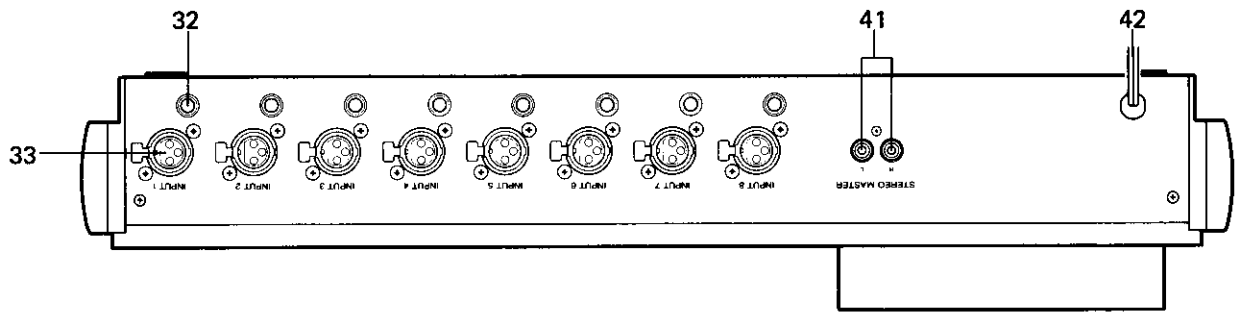

## SECTION 1 FEATURE DESCRIPTIONS

### 1. INPUT LEVEL TRIM CONTROL [TRIM]

When the Input Selector is set to INPUT, the preamplifier gain can be continuously controlled from 10dB through 50dB.

At full CW of the knob, the gain is 50dB which matches a -60dBV (1mV) mic input level at the XLR jack or the phone jack of the rear panel.

At full CCW of the knob, the gain is 10dB which matches a -20dBV (0.1V) level from an electronic musical instrument and signal processor.

When the Input Selector is set to TAPE, tape input signals from the TAPE IN phono jack of the patch panel cannot be controlled by this trim control.

### 2. INPUT SELECTOR [INPUT LINE/MIC, OFF, TAPE]

A 3-position switch for selecting signals applied to the input jacks of each channel. The center, OFF position, in a convenient way to mute the input signal.

\*LINE/MIC: In this position, signals from mic level through line level applied to the rear panel INPUT XLR or phone jack feed the preamplifier and are applied to the input fader.

\*OFF: Signals to the input fader are bypassed in this position.

\*TAPE: The recorder/reproducer output bypasses the preamplifier and is applied to the input fader in this position of the switch. Not only can this input position be used to mixdown a multitrack recorder output, but it can also be used to receive the output from an external signal processor.

### 3. AUX 1 INPUT LEVEL CONTROL [AUX 1]

This control feeds the input channels' post-fader post-equalizer signals to a summing amplifier that mixes the AUX 1 signals of all eight input channels for the AUX 1 jack. This mono mix may be used to feed external signal processing equipment.

### 4. INPUT SELECTOR FOR AUX 2 OUTPUT [AUX 2]

Input signals to be sent to the AUX 2 buss out are selected by this 3 position switch.

\*PRE: In this position, the input signal is pre-fader and pre-equalizer.

\*POST: In this position, the input signal is post fader and post-equalizer.

\*TAPE: The output of the recorder is the input signal at this position.

### 5. GAIN POT FOR AUX 2 BUSS OUT [GAIN]

Gain pot for adjusting the level of the signal selected by switch 4), above.

### 6. PAN POT FOR AUX 2 BUSS OUT [PAN]

A 2-channel PAN pot. With the 12 o'clock knob position as center, CCW rotation will increase the left channel level of the 2-channel buss out and decrease the right channel level at the same time (vice-versa for CW rotation).

### 7. 4-CHANNEL BUSS OUT SELECTOR [ASSIGN]

In combination with the PAN pot located directly under this selector, it assigns the input signal to the 4-channel buss out.

\*1-2: In this selector position, the PAN pot can control only the signals between CHAN 1 and CHAN 2 of the 4-channel buss out.

\*OFF: In this position, signals from the input section to the 4-channel buss out are switched off.

For example, if you were mixing the 4-channel buss out with the output of an echo or reverberation unit by using the 4-channel buss input, and you wanted to monitor echo or reverberation return only, turn this switch OFF.

\*3-4: In this selector position, the PAN pot can control only the signals between CHAN 3 and CHAN 4 of the 4-channel buss out.

### 8. PAN POT FOR 4-CHANNEL BUSS OUT [PAN]

The signals selected by the 4-channel buss out selector of 7), above, can be pan controlled by this pot for CHAN 1 only, CHAN 1 and 2, or CHAN 2 only (CHAN 3 only, CHAN 3 and 4, or CHAN 4 only).

The 12 o'clock position of the PAN pot is center. If it is rotated CCW, the signal applied to CHAN 1 (or CHAN 3) increases and that to CHAN 2 (or CHAN 4) decreases (vice-versa for CW rotation).

### 9. PARAMETRIC EQUALIZER [EQ]

A 2-band parametric equalizer for 60Hz ~ 1kHz and 400Hz ~ 6kHz, and a shelving type equalizer for 10kHz. Boost and cut levels are  $\pm 15$ dB (max).

### 10. INPUT SOLO BUTTON [SOLO]

When the SOLO button of any channel is depressed, the headphone output and monitor output normally present changes to post fader and equalizer input.

The SOLO buttons are lock type switches.

The SOLO functions are for MON OUT and PHONE OUT and do not affect the 4-channel buss out.

### 11. OVERLOAD/SOLO INDICATOR

Indicates the input solo mode when the SOLO button is depressed or when this button is released, overload at the preamplifier output.

### 12. INPUT FADER

The optimum level, relative to noise and distortion, is obtained when the input fader knob is set at 0dB.

Therefore, it is advisable to first set the input fader at this point and then set the overall level by the input trim control.

### 13. 4-CHANNEL BUSS OUT SOLO BUTTON [SOLO]

The 4-channel buss out signals for each channel can be monitored individually via the pre-fader. Using the same logic as input solo, monitor signals at MON OUT and PHONES are changed to 4-channel buss out signals.

### 14. 4-CHANNEL BUSS INPUT LEVEL CONTROL [BUSS INPUT]

For individual level control of each channel. Effects return signals applied to the 4-channel BUSS IN jacks on the patch panel or signals from another mixer are controlled here.

### 15. PAN POT FOR STEREO MASTER OUTPUT [BUSS PAN]

This pan pot has the function of mixing the 4-channel buss out signals with the stereo master output.

### 16. MONITOR SELECT BUTTONS

With these buttons, either channel 1, 2, 3 or 4 of the 4-channel buss out, output of AUX 1, or output of channel L/R of AUX 2 buss out can be selected and applied to PHONES and MONITOR OUT.

Seven push buttons for channels 1, 2, 3, 4 AUX 1 and AUX 2

L/R can be divided into four groups — channels 1 and 2, 3 and 4, AUX 1 and AUX 2 L/R.

By pressing the 1 and 2 buttons together, the signal from channel 1 is applied to the left channel of PHONES and MONITOR OUT, and the signal from channel 2 is applied to the right channel. Press either 1 or 2, and the signal selected can be applied to both the left and right channels.

The 3 and 4 group functions in the same way as group 1 and 2. When the AUX 1 button is depressed, the AUX 1 signal is applied to both PHONES and MONITOR OUT.

The group function of the AUX 2 button is the same as for BUSS 1 and 2 or BUSS 3 and 4.

When the four button groups (BUSS 1 and 2, BUSS 3 and 4, AUX 1, and AUX 2) are simultaneously depressed, these signals will be mixed and applied to PHONES and MONITOR OUT.

#### **17. METER SELECT SWITCH [METER]**

Chooses the four LED bargraph meter display for 4-channel buss out signals or the stereo master outputs.

When set for stereo master out, the two LED bargraph meters at the right side will not function.

#### **18. SOLO LEVEL CONTROL [SOLO]**

This is the knob to control monitor level of the input channel solo and 4-channel buss out solo signal.

As monitor levels are normally set first (see the following items 19) and 20), solo level is generally set second.

#### **19. MONITOR LEVEL CONTROL [MONITOR]**

This pot controls the monitor output level.

#### **20. HEADPHONE LEVEL CONTROL [PHONES]**

#### **21. STEREO MASTER OUTPUT LEVEL CONTROL [STEREO MASTER]**

The master level control of the 4-channel buss output signal mixed down to stereo.

#### **22. 4-CHANNEL BUSS MASTER FADER**

#### **23. HEADPHONE JACK [PHONES]**

These two jacks are wired in parallel.

#### **24. LED BARGRAPH METERS**

These display levels of the 4-channel buss output or stereo master output.

#### **25. SOLO INDICATOR [SOLO]**

This LED is lit when either the input channel solo or 4-channel buss out solo button is depressed.

#### **26. POWER INDICATOR [POWER]**

#### **27. POWER SWITCH [POWER]**

#### **28. PHANTOM POWER SWITCH [PHANTOM]**

Phantom power supply voltage is 48V DC.

#### **29. DIRECT OUT JACK [D. OUT]**

This output stage is immediately after the input fader and parametric equalizer.

#### **30. TAPE IN JACK [TAPE IN]**

Input jacks for receiving (normally) the outputs from a multi-track recorder. In addition, these jacks can be used to connect outputs from reverberation units, compressor/limiters and other line level sources.

#### **31. ACCESSORY SEND/RECEIVE JACK [ACC SEND RCV]**

This is the patch point, between the preamplifier output and the input fader, where a signal processor, such as an equalizer, is plugged in.

#### **32. PHONE JACK INPUTS [INPUT]**

These input jacks are for unbalanced inputs from mic level to line level: from  $-60\text{dBV}$  (1mV) through  $-20\text{dBV}$  (0.1V). Input impedance is about 50K ohms.

#### **33. XLR JACK INPUTS [INPUT]**

These jacks are for balanced mic input signals and will handle levels of  $-60\text{dBV}$  (1mV) through  $-20\text{dBV}$  (0.1V).

Unbalanced signals can also be handled by these XLR jacks: pins #1 and #2 will be GND; PHANTOM must be switched OFF.

#### **34. 4-CHANNEL BUSS IN [4 CHAN BUSS IN]**

Input jacks for mixing the outputs from an external processor into the 4-channel buss line.

#### **35. 4-CHANNEL BUSS OUT [4 CHAN BUSS OUT]**

Normally, these jacks will feed a multitrack recorder.

#### **36. AUX 2 BUSS IN [AUX 2 IN]**

Input jacks for mixing the outputs from an external processor into the AUX 2 buss line.

#### **37. AUX 2 BUSS OUT [AUX 2 OUT]**

The AUX 2 buss output jacks are for a monitor amplifier, master recorder, etc.

#### **38. AUX 1 BUSS IN [AUX 1 IN]**

Input jacks for mixing the outputs from an external processor into the AUX 1 buss line.

#### **39. AUX 1 BUSS OUT [AUX 1 OUT]**

The AUX 1 buss output jacks are for signal processors, slap echo recorders, etc.

#### **40. MONITOR OUTPUT [MON OUT]**

The 4-channel buss out, the AUX 1 buss out or the AUX 2 buss out, as selected by the MONITOR select switch, is active here. These outputs are generally connected to the cue and monitor amplifiers.

#### **41. STEREO MASTER OUTPUT [STEREO MASTER]**

The 4-channel buss out after mixdown to stereo is the output here, and it is generally applied to the 2-channel master recorder.

#### **42. AC POWER CORD**

## SECTION 2 INTRODUCTION

The Fostex Model 450 is one of the most flexible, versatile mixers ever designed for its price category. With a complement of features such as phantom power, in-line monitoring, input solo and multiple send/receive circuits and patch points, this 8x8x4x2 mixer can be used in a wide variety of creative applications. From multitrack recording to complex sound reinforcement, the 450 delivers quality audio, direct or through the summing amplifiers, pre- or post- EQ and fader. Anywhere you need it; however you want it to sound.

Fostex's engineers, who pioneered the development of personal multitrack and mixing equipment, designed the 450 to meet the needs of the serious small studio or production facility as well as stage and P.A. users. It combines ease of operation, reliability and flexibility in an extremely compact package, and is particularly compatible with multitrack equipment such as the Fostex 8-track, 1/4" recorder Model 80. Your 450 should provide years of top audio performance with a minimum of service, using reasonable care.

### HOW TO USE THIS MANUAL

While it may be possible to "get by" without reading this manual, the utmost in creative results can only be obtained when one is thoroughly acquainted with the 450 and its full capabilities. We suggest quickly reading this manual once before using the 450, then re-reading the manual later, after becoming familiar with the basic functions of the mixer.

Section 1 contains brief descriptions of each feature and control. This is handy for quick references, although for a more detailed step-by-step guide to connection and use, consult Section 3. The remainder of the manual will illustrate in more detail, the use of external processing equipment, the equalizers, and examples of mixing for multitrack, production, and P.A. Then, most important, study and refer to the block diagram in Section 10. You will find this to be an important aid when reading the use and applications sections of this manual, as well as providing you with more specific knowledge of the 450 and its remarkable potential.

## SECTION 3 INTERCONNECTIONS AND INSTALLATION

Whatever the application, certain standard procedures should be followed in setting up the mixer for use.

The power cord of the mixer should be connected to an AC supply of the correct voltage.

While the output of the Model 450 incorporate a circuit to prevent an audible power on "thump", it is always advisable to turn the power on to amplifiers or tape recorders connected to the outputs of the mixer AFTER the mixer has been switched on.

### CONNECTING THE INPUTS

The input circuits of the Model 450 are such that they may accommodate an extremely wide range of input signals. You may connect virtually any signal, ranging from microphones to electric musical instruments level, directly to the input jack.

Each balanced XLR mic input has a phantom power switch for use with certain condenser microphones.

**NOTE:** *Never connect any signal output rated in "Watts" to any input of the Model 450. These are often high voltage signals ordinarily intended for loudspeakers. If you need to make such a connection use a "Direct Injection" or "DI" box, or direct box obtainable from your dealer. Failure to do this may result in damage to the circuits of the Model 450, and/or the power amplifier.*

To set the input trim, adjust this control on maximum signal peaks until the LED above the corresponding fader just ceases to flash. This will be the optimum input level. Should the signal level rise, the LED will start to flash again, giving you clear indication that you should reduce the setting of the trim control again. "Tape in" (18) and "buss in" (21), accept a -10dBV (0.3V) level. This is compatible with all Fostex recording equipment and most other musicians' studio equipment. These inputs will also accept a nominal level of 0dBm, which are standards in many professional studios, though the overload headroom will be somewhat lower.

Remember, as long as your input LED is not flashing, you are not overloading any of the input amplifiers. If required you can include a simple input attenuator in line with your input signal. If in doubt consult your dealer.

### CONNECTING THE OUTPUTS

All outputs are at a nominal -10dBV (0.3V) level. This signal level is compatible with all Fostex recording equipment and most other musician's studio equipment.

While you may find that certain recorders, amplifiers or signal processors are specified with a nominal "0dBm" or "0dBV" level, these often have a front panel input control or pre-set which will readily accommodate this -10dBV level.

It is important to set the input level control on equipment connected to the mixer outputs, to an optimum setting to achieve the best minimum noise, and maximum overload performance.

Setting correct levels is a prime factor in attaining the maximum dynamic range performance from any professional audio system. While presetting inputs to external equipment need only be done once, individual input channel levels must be trimmed when mixing various sources via various microphones.

## SECTION 4 EXTERNAL EFFECTS AND PROCESSING

The nearest thing in real life to what is commonly termed echo, is the effect of the repeats which you hear when you shout in the midst of a mountain range. In the studio this can be achieved by feeding the output of the play head of a tape recorder or special tape loop deck back to the record heads. Many electronic devices using digital electronics are available, and these do much the same job. This effect is normally reserved as a special effect only, and should not be confused with reverberation. The sound of reverb is similar to that of a large empty concert hall. Reflections of the original sound are so close and diffuse, that no distinct repeats are heard. This effect is often simulated by devices employing a large metal plate or torsionally driven coiled springs. The effect is normally used to fill out the sound of a vocal or instrument which has been closed-miked, or is otherwise void of natural reverberation. Added judiciously it will provide commercial fullness and body to a recording. Used excessively it can create exaggerated illusions of space and loss of clarity and intelligibility.

The echo or reverb effect is proportionately added to the direct signal passing through the mixer.

The following describes how to connect either an echo or reverb, or in fact any other effect such as a phaser, flanger, doubler, etc., to the Model 450 signal path.

Figure 4-1. A single channel processor is patched to an input channel, pre-fader, pre-EQ.

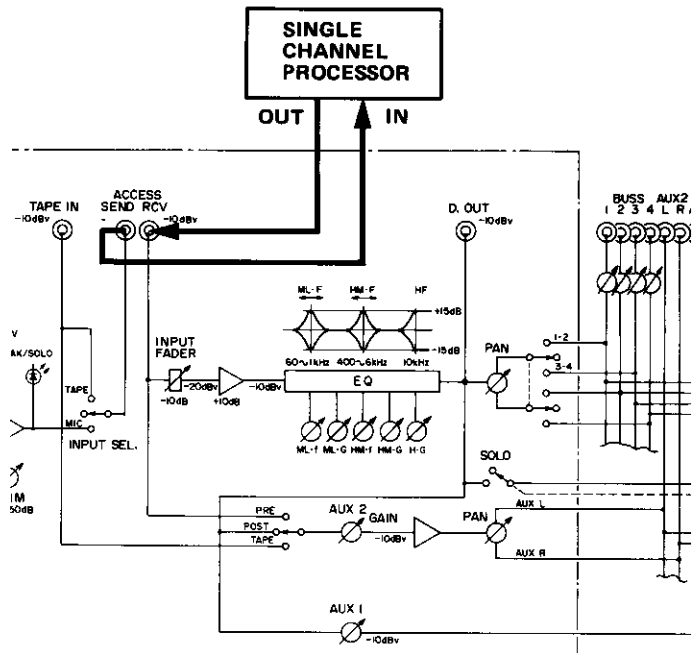

**NOTE:** This method of connecting the effector (Noise gate, limiter/compressor, chorus unit, etc.) is very effective when directly processing the original sound.

Figure 4-2. There are two ways to patch a single channel processor, post-fader, post-EQ. (A) Aux 1 out to processor to Buss in; (B) direct out to processor to buss in

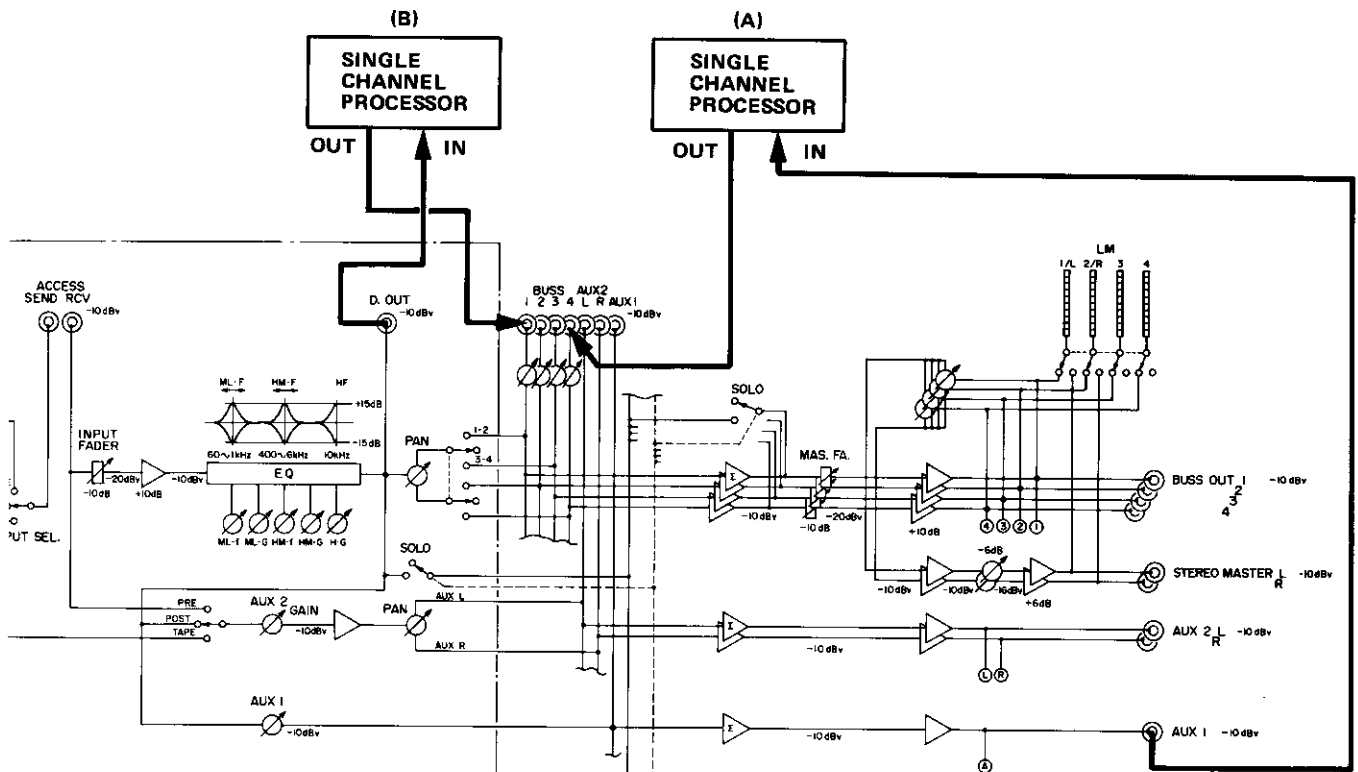

**NOTE:** This method of connecting the effector (Digital delay, reverberation, etc.) is very effective when adding the processed sound to the original sound.

Figure 4-3. A stereo processor is patched to the Aux 2 buss with your choice of pre- or post-EQ and fader

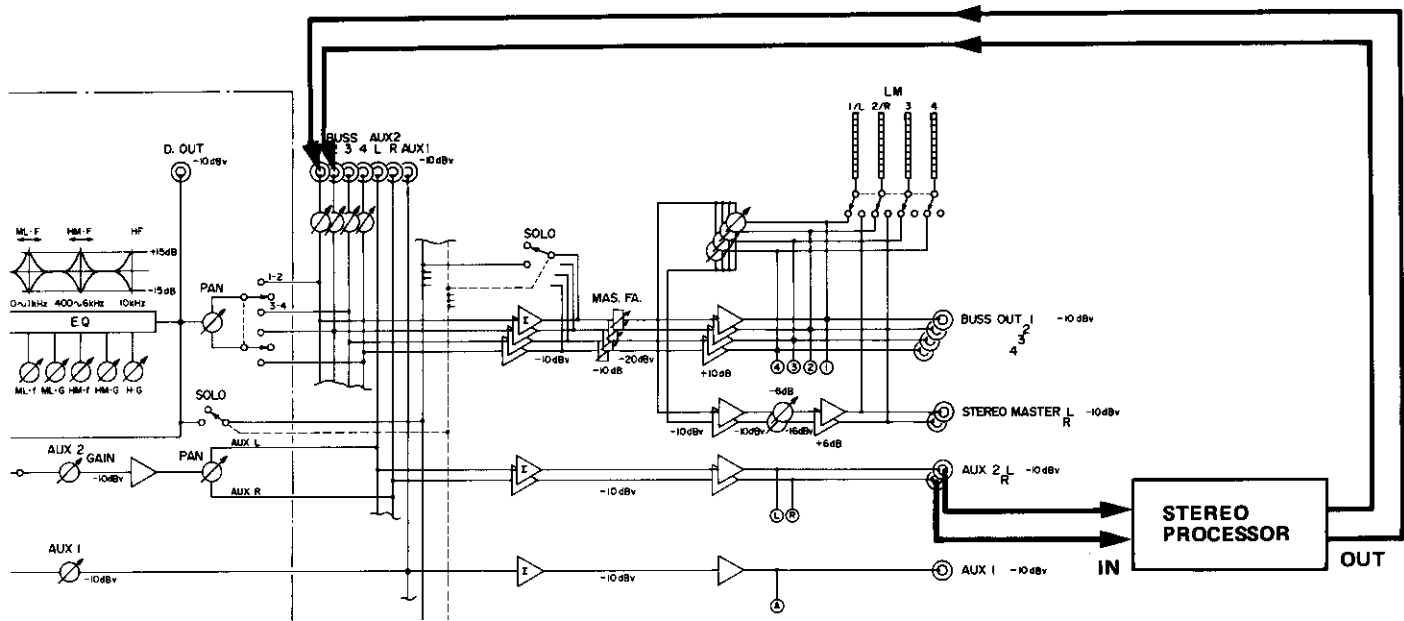

## SECTION 5 USING THE PARAMETRIC EQUALIZER

The Model 450 incorporates one fixed and two band parametric type equalizers which have considerable advantage in fine-tuning.

When equalizing individual instruments it is preferable to emphasize a narrow band around a preselected frequency. While a graphic equalizer or switched frequency may provide a greater selection of frequencies, the parametric design permits you to find the fundamental tonal qualities of instruments of those frequency bands which give you the maximum control over the sound. In PA applications, you will find that you can tune out acoustic feedback or ringing, or correct a gross house resonance.

**IMPORTANT:** Before using any equalizer, always try to achieve the sound that you want by moving the position of the microphone or changing the microphone type. Learn to use good microphone techniques before applying electronic tone correction.

### TYPICAL EQUALIZATION RESPONSE GRAPH

INSTRUMENT	CUTTING	BOOSTING	OTHER COMMENTS
Human Voice	Scratchy at 2kHz Nasal at 1kHz Popping p's below 80Hz.	Hot at 8 or 12kHz Clarity above 3kHz Body at 200-400Hz	Tend towards thin when blending many voices
Piano	Tinny at 1-2kHz Boomy at 320Hz	Presence at 5kHz Bass at 125Hz	Not too much bass when mixing with rhythm section
Electric Guitar	Muddy below 80Hz	Clarity at 3.2kHz Bass at 125Hz	
Acoustic Guitar	Tinny at 2-3.2kHz Boomy at 200Hz	Sparkle above 5kHz Full at 125Hz	
Electric Bass	Tinny at 1kHz Boomy at 125Hz	Growl at 620Hz Bass below 80Hz	Sound varies greatly with strings used
String Bass	Hollow at 620Hz Boomy at 200Hz	Slap at 3.2-5kHz Bass below 200Hz	
Snare Drum	Annoying at 1kHz	Crisp above 2kHz Full at 125Hz Deep at 80Hz	Also try adjusting tightness of snare wires.
Bass Drum	Floppy at 620Hz Boomy below 80Hz	Slap at 3.2-5kHz Bass at 80-125Hz	Usually record with front drum head off Put blanket inside of drum resting against the head.



## SECTION 6 MULTITRACK APPLICATIONS

Multitrack recording is generally considered to be the process of recording a performance in sequence, building tracks one or more at a time, then reviewing, changing, and adding new ideas, until each part is idealized. A single performer can thus create an entity not possible in real time, or individuals in a group may perform as many (or few) "takes" as necessary without imposing on the others. When all tracks have been satisfactorily recorded, one can take whatever time is required to combine them into an artistic composite in the "mixdown" process. Even at this point, flexibilities are available to change the sound or character of the separate tracks by means of electronic effects. Further, a performer not available at the initial recording date may be included hours, days or weeks later. It is this process that the commercial recording companies have come to rely on, both in terms of economics as well as artistic flexibility. The "personal multitrack" concept of Fostex has made this process available to the independent musician. Typically, the procedure begins with a basic rhythm track which provides the "reference" for the sections to come. Unlike ordinary real-time recording in mono or stereo, relative balance of the instruments or ensemble is of no concern during the recording phase (unless they are combined on a given track). Rather, an emphasis is made in getting the maximum undistorted level on each track in the interest of maximizing signal-to-noise ratios. Final balance is achieved during mix-down or re-recording, and the end product is a conventional mono or stereo tape.

While specifically designed to work with the Fostex Model 80 and Model 20 recorders, the mixer will interface satisfactorily with most makes of recorders, provided that levels are matched correctly.

### RECORDING BASIC TRACKS

The recording of signal onto separate tracks is reasonably straight-forward. Once levels have been set, route the inputs by way of the channel buss (7) and pan pot (8) to whichever tracks are selected. For four channel recording, output busses correspond to tracks 1, 2, 3 and 4, for the eight track patch shown below, they are also applied to tracks 5, 6, 7 and 8 respectively.

Figure 6-1, Record rhythm section on tracks 1 and 2.

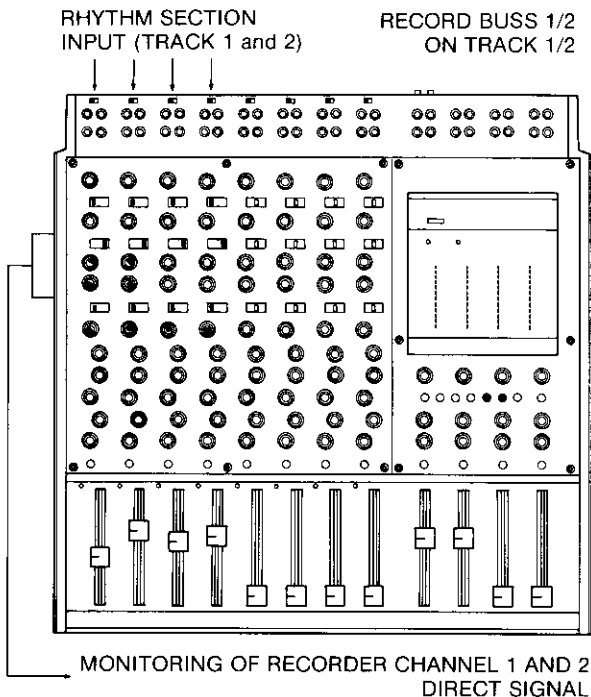

### OVERDUBBING AND MONITORING

During the recording and overdubbing process, monitoring what you are recording as well as what is on tape is the key to a successful session. It's important to become fully acquainted with the multitrack monitoring facilities offered by the Model 450.

Figure 6-2, Overdub lead instruments on tracks 3 and 4.

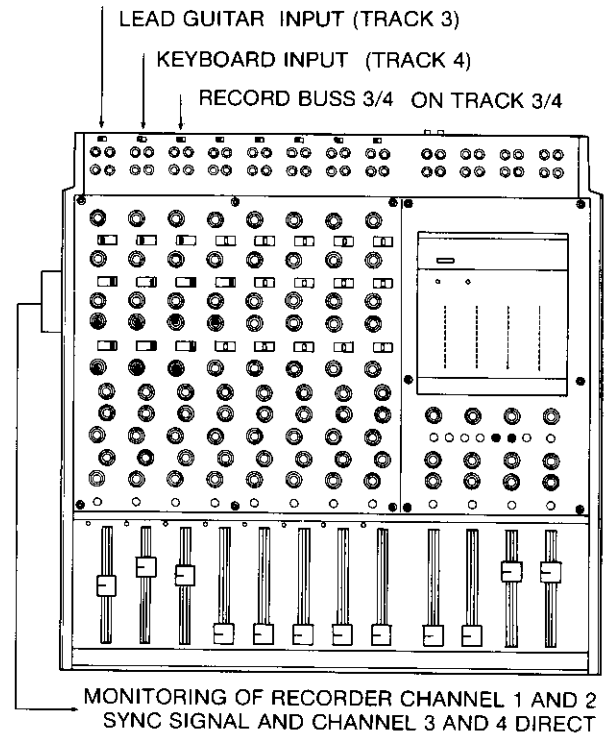
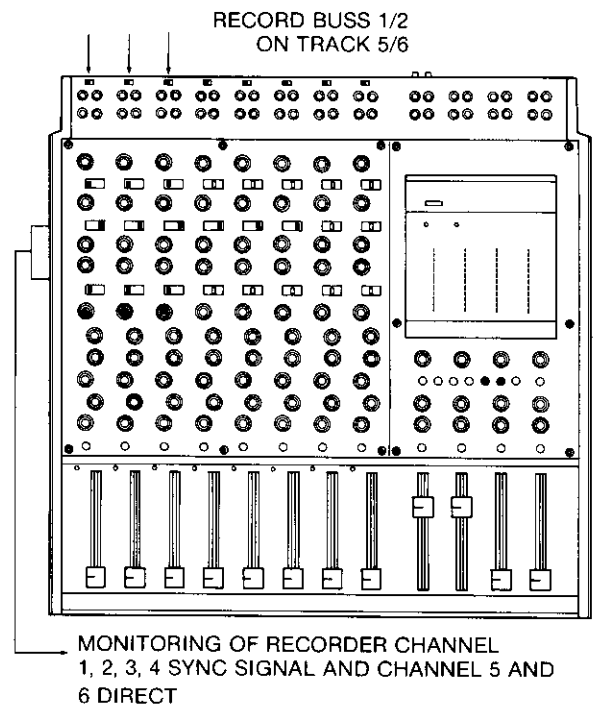

Figure 6-3, Final overdub of vocals on tracks 5 and 6. VOCAL MICROPHONES (TRACK 5 and 6)



The AUX 2 Buss is a natural monitor mix buss for overdubs. You have separate control over pan and gain for each channel; that is, these controls have no effect on the signal(s) being sent to the recorder (see Block Diagram, Pg. 13 ).

The 450 is particularly well-designed for punch-ins. Unlike most other mixing consoles, the 450 has "in-line monitoring." This enables you to use only one input channel to do punch-ins/outs. Most other 8x4x2 boards require you to use one channel for monitoring the old track and another channel for monitoring the punch-in.

To use the 450 for punching-in, first set the input select switch to "input." Second, set the channel assign selector to any desired position (except off). Third, select the same 4 channel buss on the monitor section. This will enable you to monitor your new track. To simultaneously monitor the old track, switch Aux 2 to "tape," and (if you want to monitor in stereo) set the pan control to the center. Then punch up both L and R of AUX 2 on the monitor switch panel. Press "play" on the recorder and then adjust the Aux 2 gain and monitor level to hear the original track. Then adjust the channel "trim" & "fader" controls to get the proper balance between the old and new tracks through the monitor mix. Make sure the gain and input fader controls are also adjusted to give you the correct level on the recorder.

Once the reference levels have been set, you'll be able to punch-in and out (monitoring must be for AUX 2 only), fixing small mistakes, faster and more easily than you ever have.

## MIXDOWN

When all the required tracks have been recorded, they must be finally mixed together, adding effects, to a mono or stereo master tape. The Model 450 offers facilities to do this with no need to repatch the system.

For mixdown, switch the appropriate "input selectors" (2) to the "tape" position. Mixdown the four channel buss out to STEREO MASTER by using PAN pot (15). Tape out signals are then selected and grouped as desired by the four channel buss out selector (7). In this format, the four channel buss master fader (22) will be the GROUP MASTER FADER.

Monitoring of STEREO MASTER is achieved by routing the 2 channel master recorder tape out to AUX 2 BUSS IN and depressing the AUX 2 L and R buttons of the Monitor Select switch. Apply equalization if required and, if you want to use an echo or other effects system, refer to section 4 of this manual.

For information on where to find out more about the art of multitrack recording, look to the list at the back of this manual.

Figure 6-4, Record final mix.

PLAYBACK ALL 6 TRACKS, SET TWO TRACKS TO RECORD, SPARE CHANNELS 7 AND 8 MAY BE USE FOR ECHO RETURN OR USE "BUSS IN" 1 AND 2

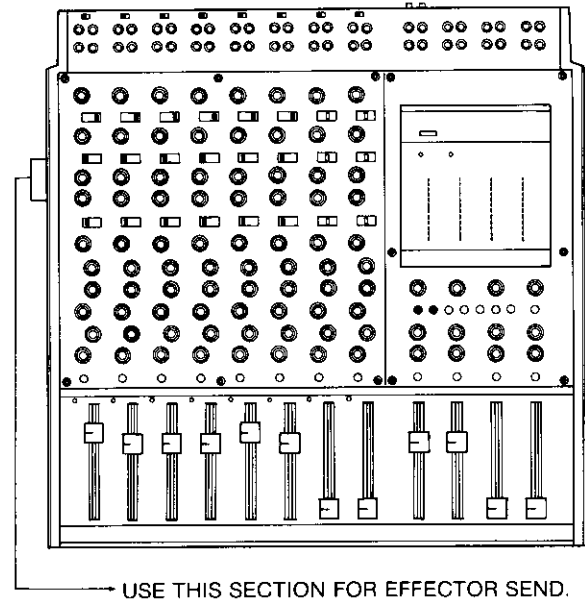

## Connecting the Model 80 to the 450

There are 2 ways to connect the 80 and the 450:

- 1) Using the 4 channel buss outputs.  
Connect these outputs from the 450 to inputs 1-4 on the Model 80, to record on tracks 5-8. You need not repatch as input jacks 5 through 8 are of the normalised type phono jacks paralalled, respectively, with input jack 1 through 4.
- 2) Using the direct outputs.  
Connect the direct outputs from each input channel to each of the 8 inputs of the Model 80 recorder.

There are pros and cons to both methods. 1) makes it possible to sub-group without re-patching, but it's impossible to record on all 8 tracks at once (for live recording). 2) lets you record all 8 tracks at once and frees up the 4 channel buss for use as an extra effects send or monitor mix, but you'll need to repatch for subgroups. 2) also bypasses the 4 channel buss summing amp, giving you a slightly cleaner signal (this is true of all mixers).

Figure 6-5

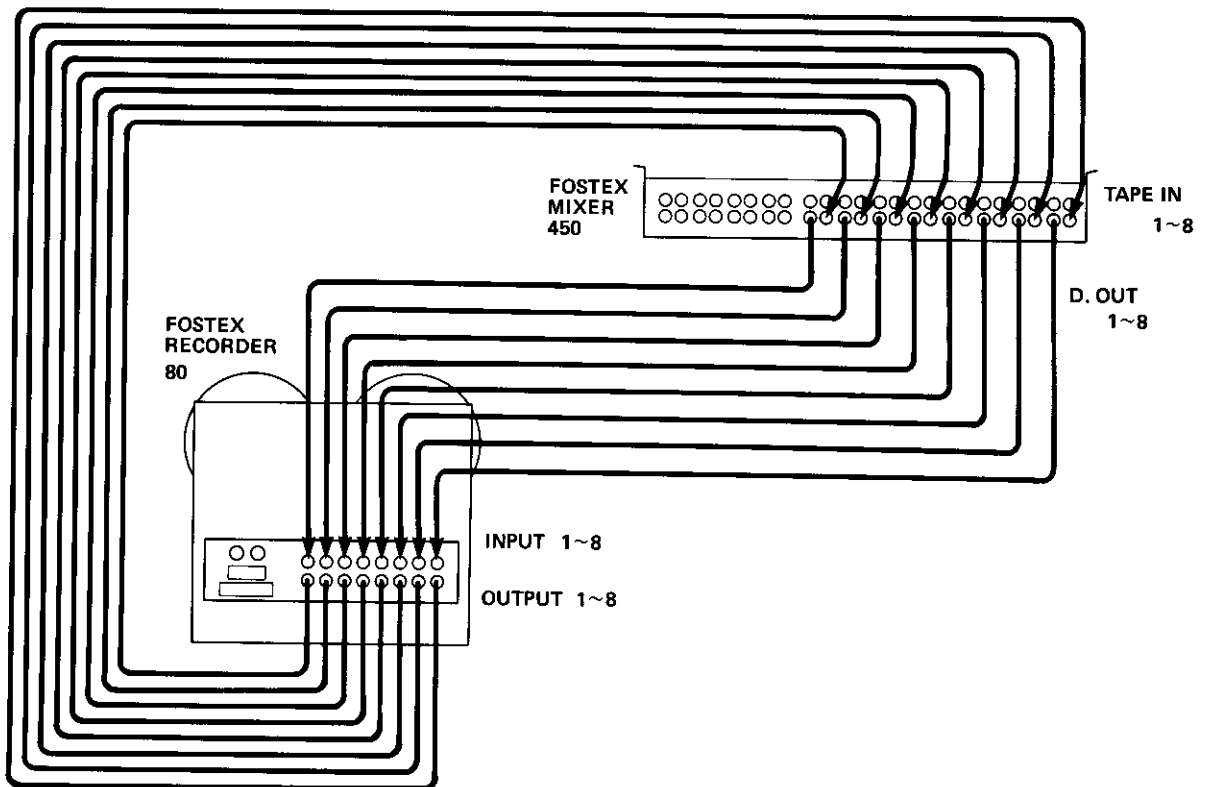
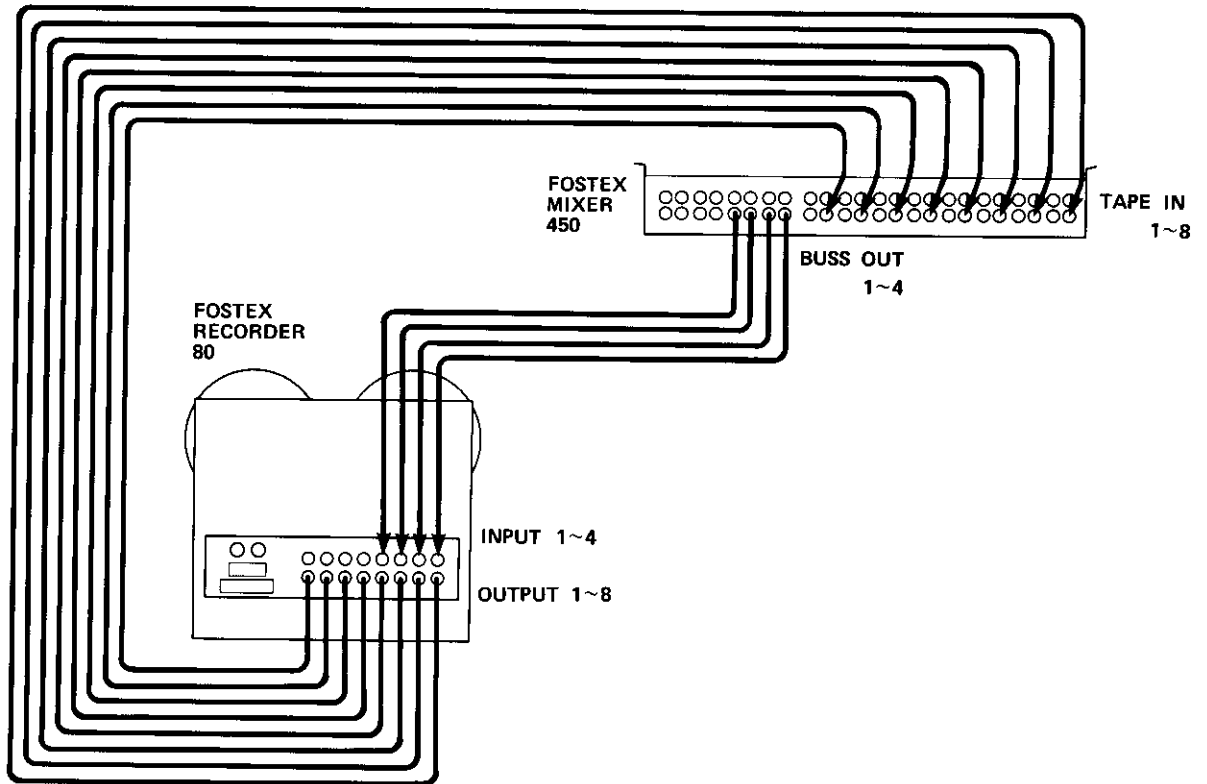

## SECTION 7 P.A. APPLICATIONS

In this PA application, the two stage mixes (AUX 2L for Center Stage — the lead singer; AUX 2R for Stage Left and Stage Right) are all post-eq and fader — which may or may not work, depending on specific feedback problems. The AUX 2 signals

would likely be pre-eq and fader, so that external eq could be used to compensate for room acoustics, speaker placement, etc.

Figure 7-1. Two separate mono mixes for the stage (left, lead vocar and right) with independent stereo house mains (STEREO OUT)

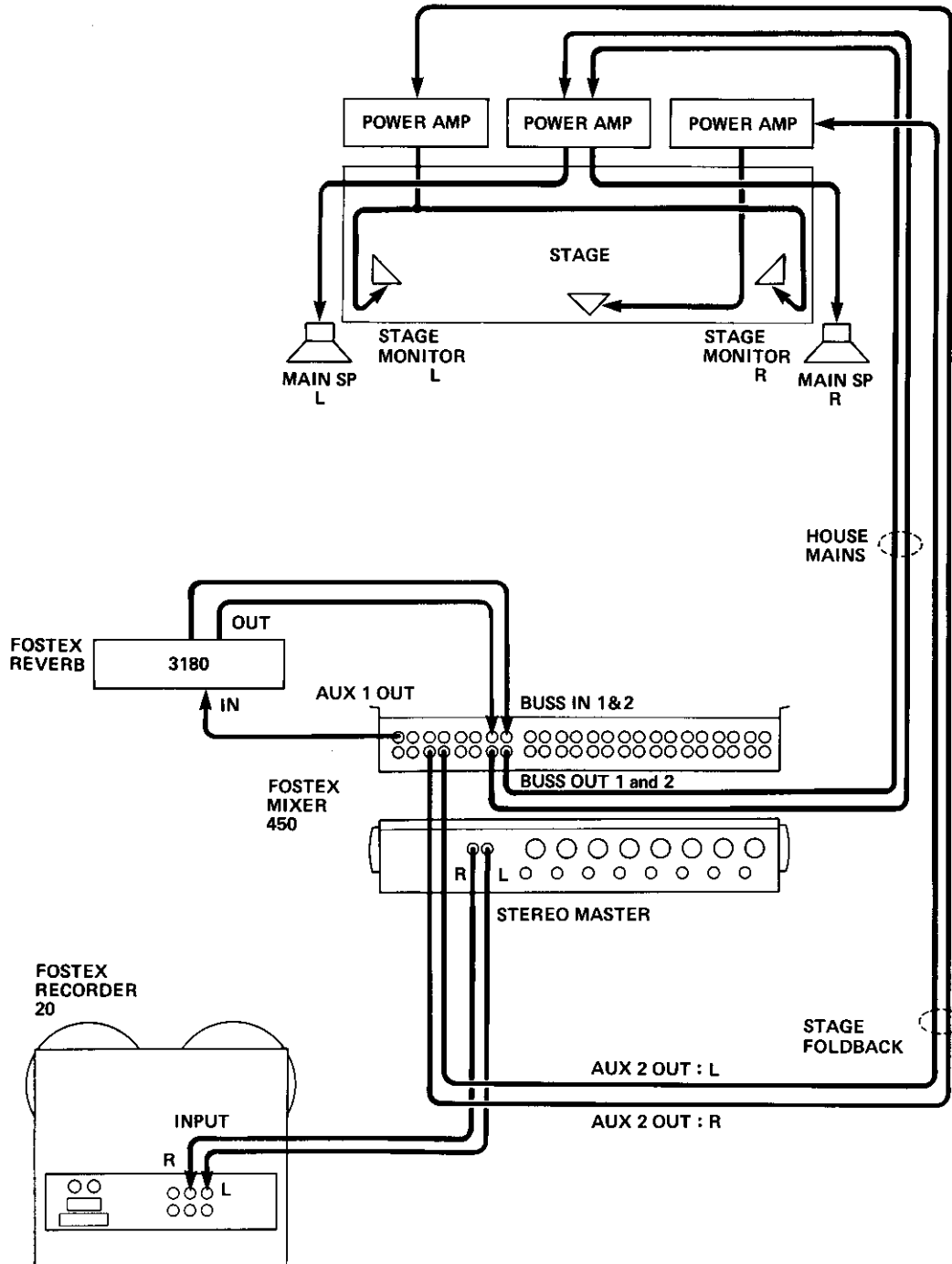

If you need extra monitor, cue, or effects mixes/sends, then you need to add the 2050 line mixer. For an extra monitor/cue mix, just take the "direct out" from each input channel and connect this to "effects" on the rear of the 2050. If you're already using the "direct out" from the 450 to go directly to the

Model 80, then wire the 2050 as in the preceding sentence, and then take the "foldback" outputs from the 2050 to the inputs of the Model 80. For PA use, simply parallel (or "chain") as many 2050s as you need for monitor mixes (the Model 450 offers as many as three monitor mixes already built-in).

Follow the same procedure if you need extra effects sends. For the effects sends, take the cue or buss outputs from the 2050 (see 2050 owner's manual for details) and connect them to the inputs of the signal processor. The outputs of the signal processor then go to any of the "4 Buss Inputs" on the 450,

depending on your needs. An extra line level mixer or two, plus a patch bay will give you fast, easy access to complex signal routing applications. Your 450 already contains the switching, patching and control capabilities to handle such complex routing.

Figure 7-2. With the simple addition of one 2050 8x8x2 line mixers, you can handle complex arrangements as shown here. Two recordings are being made: an 8-track remote and a 2-track mix.

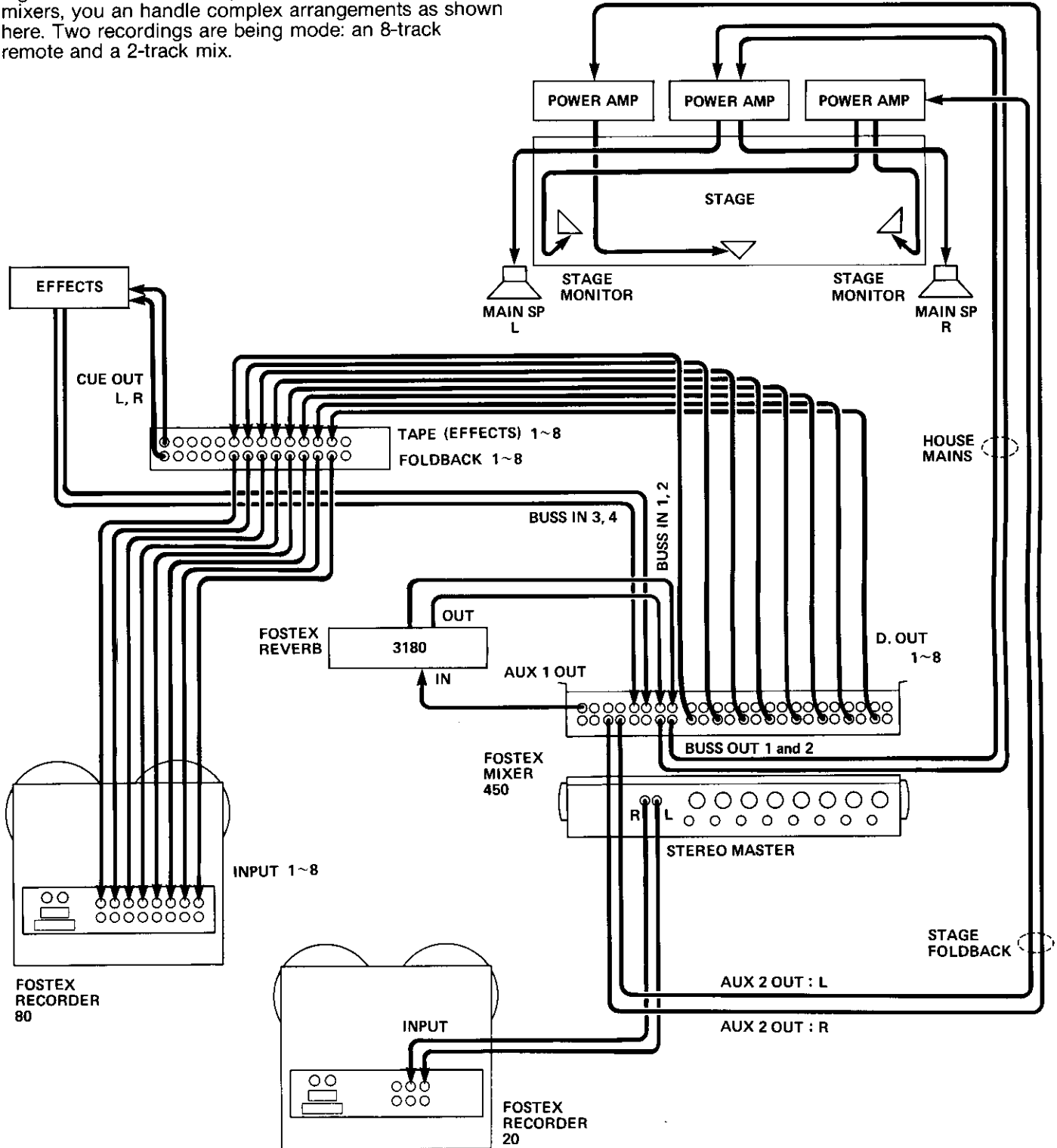

## **SECTION 8 MAINTENANCE**

Servicing should be referred only to qualified service personnel. No user-maintenance procedures are recommended other than occasional cleaning of the external surfaces with a damp soft cloth. Do not moisten cloth such that any liquid may flow into the 450. Avoid any spillage or debris into the fader slots. At Fostex we use the best components and strictly quality control all our products before they leave our factories.

If problems occur, check first that you have made all connections correctly, and you are operating the unit properly. Isolate the mixer from any external processing equipment that can interrupt the signal flow. Then recheck your input and output switching.

If you cannot solve the problem yourself or there is good reason to think that the equipment is at fault, contact your dealer or Fostex Representative.

# SECTION 9 BLOCK DIAGRAM

450

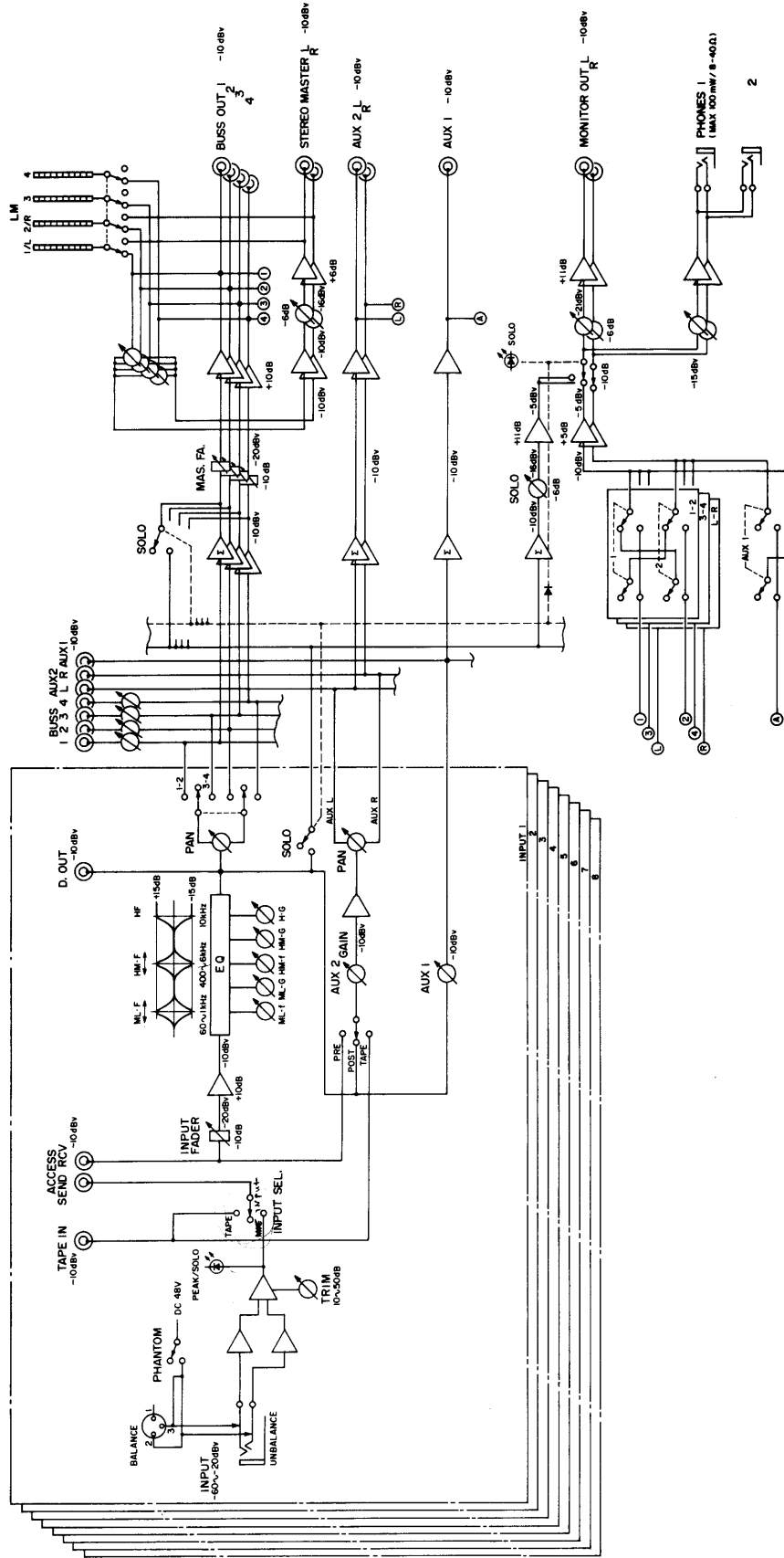

## SECTION 10 SPECIFICATIONS

### INPUT (X8)

<b>Mic impedance</b>	10K $\Omega$ or less
<b>Input impedance</b>	10K $\Omega$ balanced XLR connector and 40K $\Omega$ unbalanced phone jack
<b>Nominal input level</b>	Mic: -60dBV (1mV) Line: -20dBV (0.1V)
<b>Minimum input level</b>	-70dBV (0.3mV)
<b>Maximum input level</b>	+15dBV (5.6V)

### TAPE INPUT (X8)

<b>Input impedance</b>	10K $\Omega$
<b>Nominal input level</b>	-10dBV (0.3V)
<b>Minimum input level</b>	-20dBV (0.1V)
<b>Maximum input level</b>	+25dBV (17.8V)

### 4 CHAN BUSS IN (X4)

<b>Input impedance</b>	10K $\Omega$
<b>Nominal input level</b>	-10dBV (0.3V)
<b>Maximum input level</b>	+25dBV (18V)

### AUX 1 BUSS IN and AUX 2 BUSS IN (X2)

<b>Input impedance</b>	20K $\Omega$
<b>Nominal input level</b>	-10dBV (0.3V)
<b>Maximum input level</b>	+15dBV (5.6V)

### 4 CHAN BUSS OUT (X4)/STEREO OUT

<b>Output load impedance</b>	10K $\Omega$ or higher
<b>Nominal output level</b>	-10dBV (0.3V)
<b>Maximum output level</b>	+15dBV (5.6V)

### AUX 1 and AUX 2 OUT (X2)

<b>Output load impedance</b>	10K $\Omega$ or higher
<b>Nominal output level</b>	-10dBV (0.3V)
<b>Maximum output level</b>	+15dBV (5.6V)

### MONITOR OUT (X2)

<b>Output load impedance</b>	10K $\Omega$ or higher
<b>Nominal output level</b>	-10dBV (0.3V)
<b>Maximum output level</b>	+10dBV (3V)

### HEADPHONE OUTPUT (Stereo)

<b>Load impedance</b>	8 $\Omega$ ~40 $\Omega$
<b>Maximum output</b>	100mW at 8 $\Omega$ ~40 $\Omega$

### FREQUENCY RESPONSE

<b>Mic in</b>	20Hz~20kHz, +1/-2dB
<b>Line in</b>	20Hz~20kHz, $\pm$ 1dB
<b>Headphone</b>	80Hz~20kHz, $\pm$ 2dB

### ACCESS SEND

<b>Output load impedance</b>	10K $\Omega$ or higher
<b>Nominal output level</b>	-10dBV (0.3V)
<b>Maximum output level</b>	+15dBV (5.6V)

### EQUIVALENT INPUT NOISE

-126dB weighted
-124dB unweighted (20Hz~20kHz)

### OVERALL SIGNAL TO NOISE

<b>One mic input</b>	65dB weighted, 63dB unweighted
<b>8 mic inputs</b>	56dB weighted, 54dB unweighted
<b>One line input</b>	85dB weighted, 82dB unweighted
<b>8 line inputs</b>	75dB weighted, 72dB unweighted

### PARAMETRIC EQUALIZER

60Hz~1kHz, $\pm$ 15dB
400Hz~6kHz, $\pm$ 15dB
10kHz $\pm$ 15dB

### CROSSTALK

60dB at 1kHz
--------------

### T.H.D. (overall)

0.05% at 1kHz nominal level
-----------------------------

### FADER ATTENUATION

70dB or more at 1kHz
----------------------

### POWER REQUIREMENTS

120V AC, 60Hz, 20W (U.S.A./Canadian model)
220V AC, 50Hz, 20W (European model)
240V AC, 50Hz, 20W (UK/Australian model)

Fostex reserves the right to change specifications without notice.  
\*220-240V AC, 50Hz available outside U.S.A.

## SECTION 11 BIBLIOGRAPHY

For more information about multitrack recording techniques and creative sound in general, we recommend the following:  
A. Modern Recording Techniques: An authoritative introduction to modern recording studio technique, from the humblest setup right through to 24 track installations. Published by Howard W. Sams & Co., available through the Recording Institute of America Inc. 15 Columbus Circle, New York, New York 10023. U.S.A.

B. Various publications both constructional and theory, including "Setting Up and Using a Multi-channel Studio" #781 from: TAB Books, Blue Ridge Summit, PA 17214. U.S.A.

A Last Few Words.

As you have seen from this manual, the Model 450 is an extremely versatile mixing console. It has been designed to work specifically with other Fostex brand equipment and accessories, and is compatible with most other recording equipment. If you have any doubt about use and application, or compatibility with other equipment, check with your local dealer or Fostex Representative.

At Fostex we are ready to help you with any operational or technical difficulties that you may have, and we welcome any comments or suggestions. If you have found any new creative ways with the Model 450 please let us know.



## SAFETY INSTRUCTIONS

### WARNING

#### “READ BEFORE OPERATING”

1. Read Instructions—All the safety and operating instructions should be read before the appliance is operated.
2. Retain Instructions—The safety and operating instructions should be retained for future reference.
3. Heed Warnings—All warnings on the appliance and in the operating instructions should be adhered to.
4. Follow Instructions—All operating and use instructions should be followed.
5. Water and Moisture—The appliance should not be used near water—for example, near a bathtub, washbowl, kitchen sink, laundry tub, in a wet basement, or near a swimming pool, etc.
6. Ventilation—The appliance should be situated so that its location or position does not interfere with its proper ventilation. For example, the appliance should not be situated on a bed, sofa, rug, or similar surface that may block the ventilation openings; or, placed in a built-in installation, such as a bookcase or cabinet that may impede the flow of air through the ventilation openings.
7. Heat—The appliance should be situated away from heat sources such as radiators, heat registers, stoves, or other appliances (including amplifiers) that produce heat.
8. Power Sources—The appliance should be connected to a power supply only of the type described in the operating instructions or as marked on the appliance.
9. Power-Cord Protection—Power-supply cords should be routed so that they are not likely to be walked on or pinched by items placed upon or against them, paying particular attention to cords at plugs, convenience receptacles, and the point where they exit from the appliance.
10. Cleaning—The appliance should be cleaned only as recommended by the manufacturer.
11. Nonuse Periods—The power cord of the appliance should be unplugged from the outlet when left unused for a long period of time.
12. Object and Liquid Entry—Care should be taken so that objects do not fall and liquids are not spilled into the enclosure through openings.
13. Damage Requiring Service—The appliance should be serviced by qualified service personnel when:
  - A. The power-supply cord or the plug has been damaged; or
  - B. Objects have fallen, or liquid has been spilled into the appliance; or
  - C. The appliance has been exposed to rain; or
  - D. The appliance does not appear to operate normally or exhibits a marked change in performance; or
  - E. The appliance has been dropped, or the enclosure damaged.
14. Servicing—The user should not attempt to service the appliance beyond that described in the operating instructions. All other servicing should be referred to qualified service personnel.

**Fostex**

**FOSTEX CORPORATION** 560-3, Miyazawa-cho, Akishima, Tokyo, Japan

**FOSTEX CORPORATION OF AMERICA** 15431 Blackburn Ave., Norwalk, CA 90650, U.S.A.

©PRINTED IN JAPAN MAY 1985 3288 1080 01