

# Owner's Manual

Model  
1240/1840/2440

RECORDING MIXER

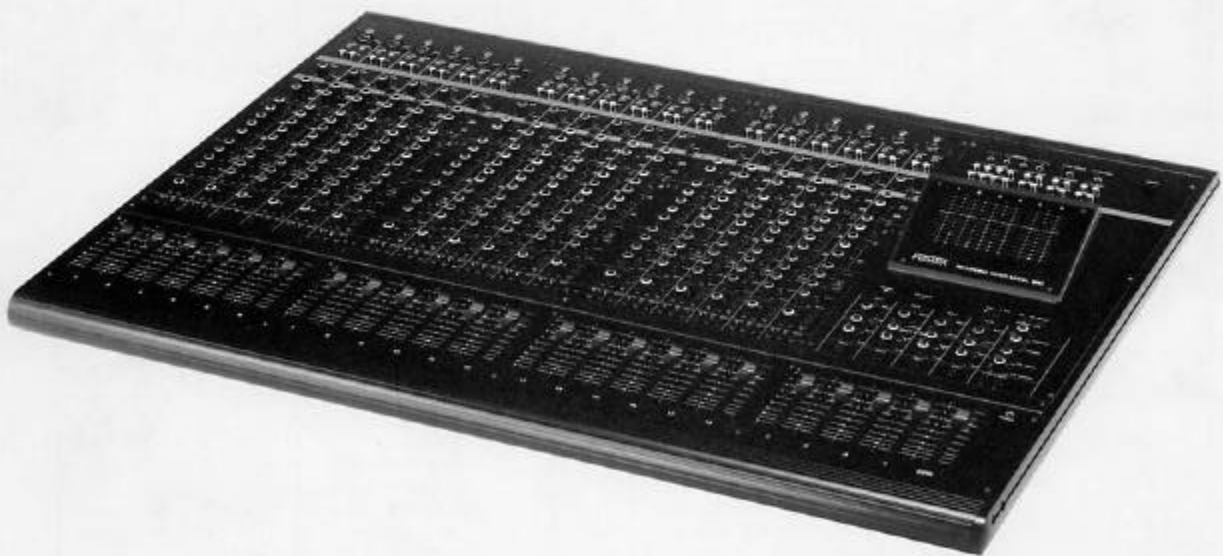

**FOSTEX**<sup>®</sup>

## SAFETY INSTRUCTIONS

1. Read Instructions — All the safety and operating instructions should be read before the appliance is operated.
2. Retain Instructions — The safety and operating instructions should be retained for future reference.
3. Heed Warnings — All warnings on the appliance and in the operating instructions should be adhered to.
4. Follow Instructions — All operating and use instructions should be followed.
5. Water and Moisture — The appliance should not be used near water — for example, near a bathtub, washbowl, kitchen sink, laundry tub, in a wet basement, or near a swimming pool, and the like.
6. Carts and Stands — The appliance should be used only with a cart or stand that is recommended by the manufacturer.
7. Ventilation — The appliance should be situated so that its location or position does not interfere with its proper ventilation. For example, the appliance should not be situated on a bed, sofa, rug, or similar surface that may block the ventilation openings; or, placed in a built-in installation, such as a bookcase or cabinet that may impede the flow of air through the ventilation openings.
8. Heat — The appliance should be situated away from heat sources such as radiators, heat registers, stoves, or other appliances (including amplifiers) that produce heat.
9. Power Sources — The appliance should be connected to a power supply only of the type described in the operating instructions or as marked on the appliance.
10. Grounding or Polarization — The precautions that should be taken so that the grounding or polarization means of an appliance is not defeated.
11. Power Cord Protection — Power supply cords should be routed so that they are not likely to be walked on or pinched by items placed upon or against them, paying particular attention to cords at plugs, convenience receptacles, and the point where they exit from the appliance.
12. Cleaning — The appliance should be cleaned only as recommended by the manufacturer.
13. Nonuse Periods — The power cord of the appliance should be unplugged from the outlet when left unused for a long period of time.
14. Object and Liquid Entry — Care should be taken so that objects do not fall and liquids are not spilled into the enclosure through openings.
15. Damage Requiring Service — The appliance should be serviced by qualified service personnel when:
  - A. The power supply cord or the plug has been damaged; or
  - B. Objects have fallen, or liquid has been spilled into the appliance; or
  - C. The appliance has been exposed to rain; or
  - D. The appliance does not appear to operate normally or exhibits a marked change in performance; or
  - E. The appliance has been dropped, or the enclosure damaged.
16. Servicing — The user should not attempt to service the appliance beyond that described in the operating instructions. All other servicing should be referred to qualified service personnel.

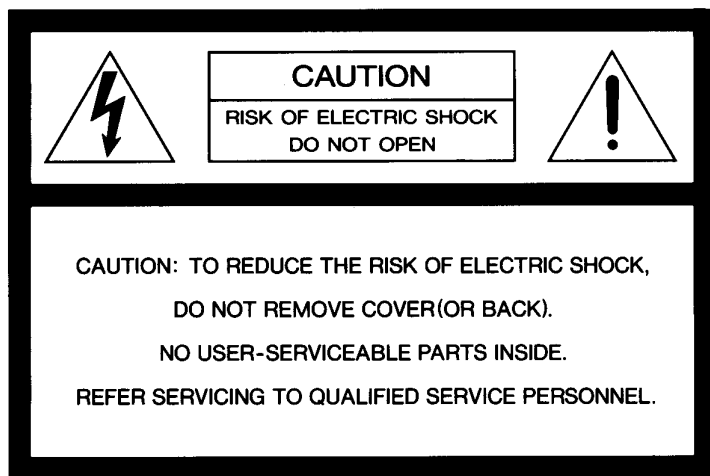

The lightning flash with arrowhead symbol, within an equilateral triangle, is intended to alert the user to the presence of uninsulated "dangerous voltage" within the product's enclosure that may be of sufficient magnitude to constitute a risk of electric shock to persons.



The exclamation point within an equilateral triangle is intended to alert the user to the presence of important operating and maintenance (servicing) instructions in the literature accompanying the appliance.

### "WARNING"

"TO REDUCE THE RISK OF FIRE OR ELECTRIC SHOCK, DO NOT EXPOSE THIS APPLIANCE TO RAIN OR MOISTURE."

# TABLE OF CONTENTS

	PAGE		PAGE
<b>SECTION 1</b> Introduction	2	<b>SECTION 6</b> Multitrack Recording	10
<b>SECTION 2</b> Name and Function/Operation of Controls and Switches	4	<b>SECTION 7</b> Other Methods of Operation	17
<b>SECTION 3</b> Connections with External Equipment	7	<b>SECTION 8</b> Trouble Shooting	18
<b>SECTION 4</b> Parametric Equalizer	8	<b>SECTION 9</b> Notes on After Service	18
<b>SECTION 5</b> Interconnections with Various Processors	9	<b>SECTION 10</b> Specifications	19
		<b>SECTION 11</b> Block Diagram	20

## SECTION 1. INTRODUCTION

Thank you for purchasing a Fostex 40-Series Mixer. Model 1240 has 12 inputs, Model 1840, 18 inputs, and Model 2440, 24 inputs. All other features are common to the series.

These consoles are particularly well-suited for multitrack recording and production/assembly applications, but they are also useful for PA and sound reinforcement.

Features include phantom powering, complete stereo solo monitoring, four channels of AUX SEND for effects processing and switchable line inputs for tape returns/musical instruments. Both signals can be monitored simultaneously without sacrificing double input channels.

A unique feature of these mixers is the fader (patent applied for). Made of a conductive rubber roller assembly, the action is much smoother and more accurate than the conventional brush type fader, plus this new design will last longer and perform more quietly -- 47 $\mu$ V p-p.

In order to use this sophisticated electronic device to its maximum potential, please read this owner's reference manual thoroughly. With proper use and maintenance, you will enjoy many years of satisfied performance.

## SAFETY PRECAUTIONS

When switching on power to this unit, always be sure it is switched on before switching on power to the peripheral equipment to which the output is connected to prevent damage to the speaker by a large noise from the monitor amplifier or to avoid shock to other equipment (recorder, etc.). Also, when plugging or unplugging cables to the input and output jacks, be sure the faders, gain, or trim levels are set to minimum ( $-\infty$ , 0 etc.).

### Connection to the power supply unit

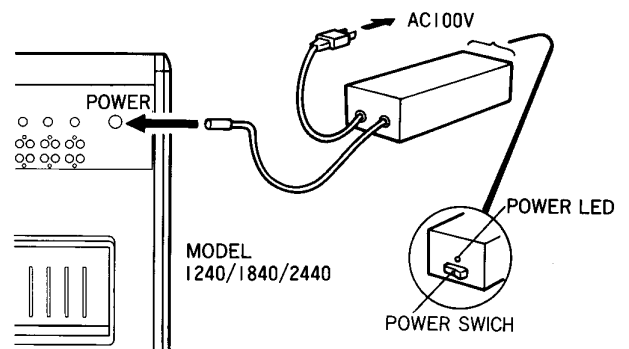

\* When POWER is switched on, the POWER LED is lit and power is applied to the main Unit. (Be sure the cable from the power supply unit is plugged into the main unit before switching on POWER.)

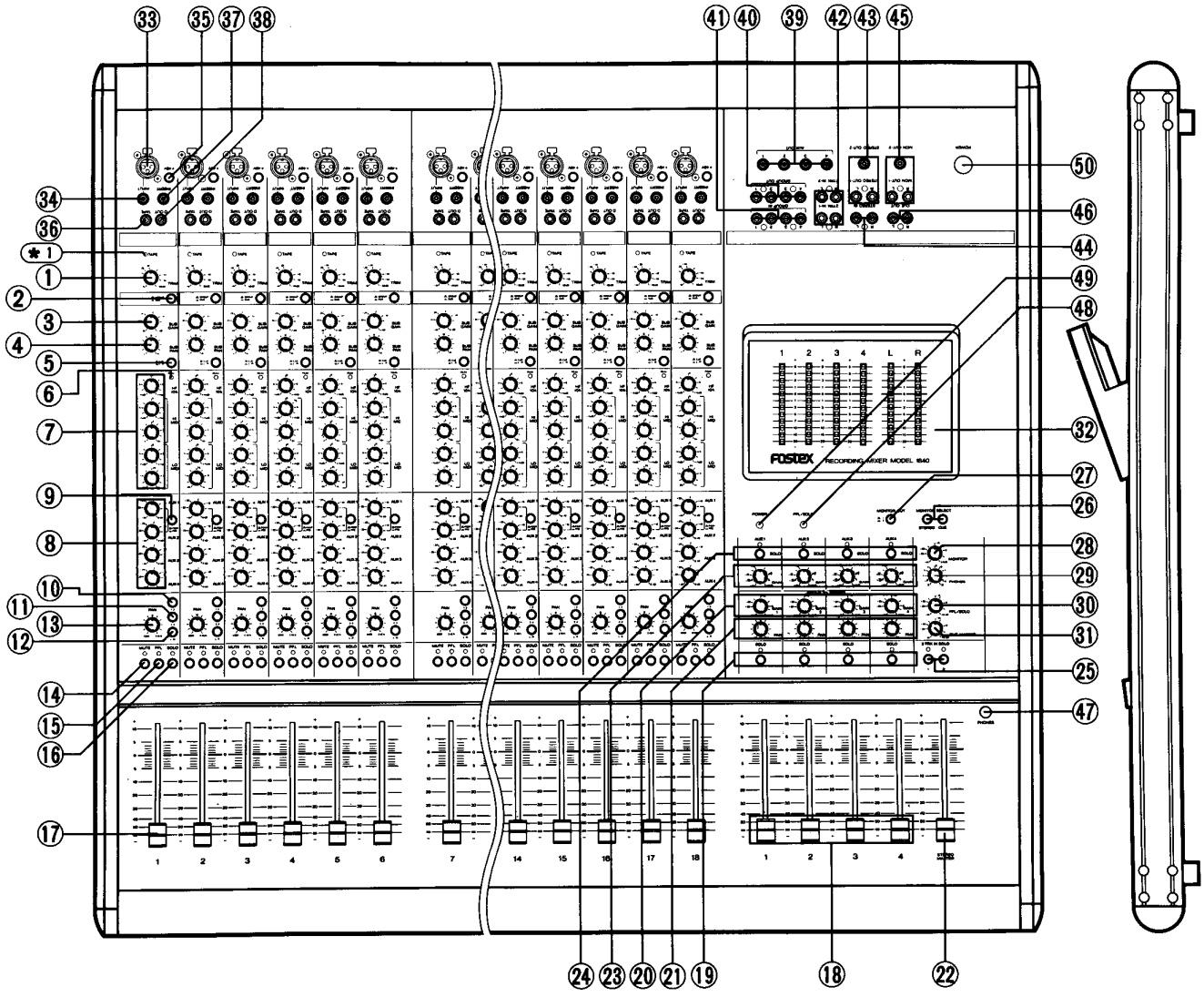

## SECTION 2. NAME AND FUNCTION/OPERATION OF CONTROLS AND SWITCHES

Letters in ( ) are identical to panel letterings. In the explanations, the panel lettering will always precede the control number. (Ex: PAN (13); EQ (7); etc.)

### 1. INPUT TRIM (TRIM)

The knob for trimming the preamplifier gain to the optimum level with regards to the input signal at the INPUT jacks (33) and (34). It can comply to a wide range from mic level (-60dBV) through line level (-10dBV).

Please note, however, that this control has no effect on the input level to the TAPE IN jack (36).

### 2. ALTERNATE SELECT SWITCH (GROUP/SUB)

The input selector switch for selecting the signal to each channel INPUT faders (17) and to the SUB MIX sections (3) and (4).

**GROUP:** Signals from INPUT jacks (33) and (34) will be routed to the INPUT fader (17), and the signal from TAPE IN jack (36) to SUB MIX sections (3) and (4).

**SUB :** The signal from TAPE IN jack (36) will be routed to the INPUT fader (17), and signals from INPUT jacks (33) and (34) to the SUB MIX sections (3) and (4).

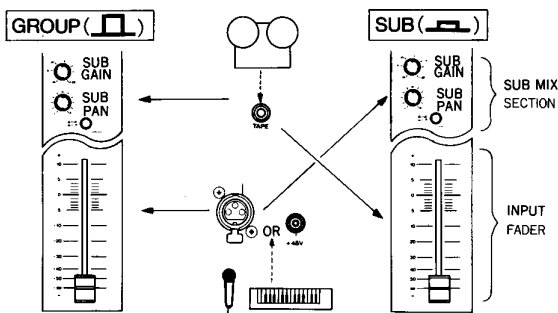

### 3. SUBMIX GAIN KNOB (SUB GAIN)

Trims the sound volume of the signal selected by (2).

### 4. SUBMIX PAN POT (SUB PAN)

Sets the right and left perspective when sending the signal selected by (2) to the buss selected by the CUE/L-R selector (5).

### 5. CUE/STEREO SELECTOR SWITCH (CUE/L-R)

Selects whether the signal, adjusted in sound volume and perspective in the SUB MIX sections (3) and (4), is to be sent to CUE buss (CUE) or the STEREO buss (L-R). When it is sent to the CUE buss, it will be output to the CUE OUT jack (46) via the CUE master level knob (31), and when sent to the STEREO buss, it will be output to STEREO OUT jacks 1~2 (43) via the STEREO master fader (22). Either signal can be monitored with the MONITOR selector (26).

### 6. PEAK LED (PEAK)

These will be lit when signals to INPUT jacks (33) and (34) or TAPE IN jacks (36) are in an overload condition (+25dB) (Not only in the preamplifier but it will also light when the EQ (7) section overloads). If this LED is lit too often, it must be set to the optimum level by TRIM (1) or TAPE trimmer (\* Refer to NOTE 1). For details, refer to "2. Level Matching With External Equipment," page 7.

### 7. PARAMETRIC EQUALIZER

Adjusts tone of the signals fed to each channel INPUT faders (17). For details, refer to "Parametric equalizer", page 8.

### 8. AUX SEND LEVEL KNOB (AUX 1 ~ 4)

The knob for adjusting the level of the four AUX send channels.

**AUX 1, AUX 2:** In relation to the PRE/POST selector (9), the prefader or post-fader (both are post equalizers) signals will be sent to AUX buss 1 and 2.

**AUX 3, AUX 4:** The post fader (post equalizer) signal is sent to AUX busses 3 and 4.

These signals sent to AUX buss 1 ~ 4 are output to AUX OUT jacks 1 ~ 4 (39) via AUX master GAIN 1 ~ 4 (23) and can be used for sends such as to at effect unit.

### 9. AUX 1, 2 INPUT SELECTOR (PRE/POST)

Selects the signal of each channel to be connected to AUX 1 and AUX 2 send (8).

**PRE :** The signal from EQ (7) and immediately before the INPUT fader (17) is connected.

**POST:** The signal passing through EQ (7) and INPUT fader (17) is connected.

### 10. GROUP 1-2 ASSIGN SWITCH (1-2)

This is switched ON (button is pressed) to send the signal input to the INPUT fader (17) to the GROUP 1, 2 buss. The signal can be assigned to 1 and 2 in any condition of balance by the PAN (13) control. The signal will not be sent to buss 1 and 2 when this switch is OFF.

### 11. GROUP 3-4 ASSIGN SWITCH (3-4)

Same as for above (10), this is switched ON (button is pressed) to send the input signal to GROUP buss 3 and 4.

### 12. STEREO L-R ASSIGN SWITCH (L-R)

Same as for above (10), this is switched ON (button is pressed) to send the input signal to the STEREO buss L, R. The signal can be assigned to L and R in any condition of balance by the PAN (13) control.

The relation between the three assign switches (10) ~ (12) and the PAN (13) control is shown below (● = ON, ○ = OFF).

Example: Sending to GROUP buss 1.



Sending to GROUP buss 4.



Sending to GROUP buss 1, 2 at same level.



Sending to GROUP buss 1 ~ 4 and STEREO buss L, R at same level.

Sending to STEREO buss R.



### 13. GROUP AND STEREO BUSS PAN POT (PAN)

In relation with the (10) ~ (12) assign switches, this control functions as shown in above schematics.

### 14. MUTE BUTTON (MUTE)

When this button is pressed, the LED above it will be lit and the signal applied to the INPUT fader (17) for that channel will be muted. As this function is the same as if the INPUT fader is quickly moved down to infinitive, it is convenient when it is desired to momentarily cut off the sound without moving the fader position.

As this mute is effective only on the signal immediately after the INPUT fader (17), it will not affect the PRE signal connected to the AUX 1, 2 send (8) or the sound monitored by pressing the PFL button (15).

### 15. PRE-FADER LISTEN BUTTON (PFL)

When this button is pressed, the LED above it will be lit and the prefader signal (post equalizer) of this channel is sent to the PFL buss (in stereo format) in center perspective. In this operation, MONITOR selector (26) is by passed, and the PFL buss output signal (the signal after passing through the PFL/SOLO level knob (30)) is sent to the MONITOR level knob (28) and the PHONES level knob (29), and therefore, you can monitor in center perspective the pre-fader signal only of the channel whose button is pressed. Please note, however, that as the signals in solo by the SOLO buttons (16), (19), (24) and (25) will also be sent to the PFL buss, these can also be monitored at the same time.

Also, when at least one of these buttons is pressed, the L, R section of the meter (32) will indicate the level of the mixed signal (signal immediately before the PFL/SOLO level knob (30)) on the PFL buss and therefore, may be used to confirm the pre-fader level. This function is effective only on the monitor system (MONITOR OUT jack 1 ~ 2 (45), PHONES jack (47), METER (32)) and has no affect on other outputs.

### 16. INPUT SOLO BUTTON (SOLO)

When this button is pressed, the LED above it will be lit and the post fader signal of this channel whose button is pressed is sent to the PFL buss. For the same reason as above (15), it will be possible to monitor the post fader signal only of the channel whose button is pressed but as the monitored sound can be confirmed in stereo in the perspective set by PAN (13), you can adjust EQ (7) without disturbing the initially planned perspective. Please note, however, that other signals sent to the PFL buss by other SOLO buttons and PFL buttons (15), will also be heard.

Also, when at least one of these buttons is pressed, the L, R section of the meter (32) will indicate the level of the mixed signal on the PFL buss and therefore, the post fader level of each channel can be easily confirmed.

This function is effective only on the monitor system (MONITOR OUT jacks 1 ~ 2 (45), PHONES jack (47), METER (32)) and has no affect on other outputs.

### 17. INPUT FADER

Adjusts the sound volume of the signal selected by

GROUP/SUB selector (2). As noise and distortion is minimum at the scale range of  $0 \pm 5$  (db), it is recommended to initially set the fader within this range, then adjust the input level with TRIM (1).

### 18. GROUP MASTER FADER (1, 2, 3, 4)

These are the individual master faders for the GROUP buss 1 ~ 4. Not only the output levels of GROUP OUT jacks 1 ~ 4 (40) but also the send level to the GROUP TO STEREO sections (20) and (21) are adjusted here.

These are normally used to set the send signal levels to a multitrack recorder.

### 19. GROUP SOLO BUTTON (SOLO)

When this button is pressed, the LED above it is lit and, for the same reason as above (16), the output signal only of the GROUP buss selected can be monitored in the center perspective. It must be noted that signals sent to the PFL buss by the SOLO button and PFL button (15) will also be heard in the monitor. In addition, if one or more SOLO button is pressed, the meter (32) L and R section will indicate the mixed signal on the PFL buss.

This function is effective only on the monitor system as in above (16).

### 20. GROUP TO STEREO GAIN KNOB (GAIN 1 ~ 4)

The knob for adjusting individual levels of the GROUP buss 1 ~ 4 output signals (the signal after passing GROUP master faders 1 ~ 4) sent to the STEREO buss. This is convenient at mixdown when you wish to group the signals by the GROUP master faders 1 ~ 4 (18) before sending them to the STEREO buss.

### 21. GROUP TO STEREO PAN POT (PAN)

This sets the left/right perspective when sending the signal from (20) to the STEREO buss. The signal from (20) and this pan pot is the output from STEREO OUT jacks 1 ~ 2 (43) via the STEREO master fader (22).

### 22. STEREO MASTER FADER (STEREO MASTER)

The master fader for the STEREO buss. Typically the master recorder is connected to STEREO OUT jacks 1 and 2 (43) and the send level can be adjusted here.

### 23. AUX MASTER GAIN KNOB (GAIN)

Adjusts the master level of the AUX buss 1 ~ 4. Levels of the signal output from AUX OUT jacks 1 ~ 4 can be set by these knobs.

### 24. AUX SOLO BUTTON (SOLO)

When this button is pressed, the LED above it is lit, and just as for the GROUP SOLO buttons 1 ~ 4 (19), the AUX buss output signal only of the button pressed can be monitored at the center perspective. It must be noted, however, that the signals sent to the PFL buss by the SOLO buttons and PFL buttons (15) will also be heard in the monitor.

Also, if even one of these buttons is pressed, the meter (32) L, R sections will indicate the mixed signal of the PFL buss and therefore may be used to confirm the output levels at the AUX OUT jacks 1 ~ 4 (39). This function is effective only on the monitor system in the same way as in (19).

## 25. 2 TRACK IN SOLO BUTTON (2 TRK IN SOLO 1, 2)

This is pressed to monitor the master recorder output connected to the 2 TRK IN jacks 1 and 2 (42). When this button is pressed, the LED above it will be lit and, as for other SOLO buttons, the input signal from the 2 TRK IN jack (42) corresponding to the button number (1 or 2) that is pressed, can be monitored via the PFL buss. Also, if one of either button is pressed, the meter L, R section will indicate the mixed signal of the PFL buss and thus may be used to confirm the output level of the master recorder that is connected. This function is effective only on the monitor system as in (24).

## 26. MONITOR SELECTOR (MONITOR SELECT)

Selects the signal to be sent to the MONITOR OUT jacks 1 ~ 2 (45) and PHONES jack (47).

**STEREO:** Signals (STEREO buss output signals) output from the STEREO OUT jacks 1 and 2 (43) can be monitored.

**CUE :** Signals (CUE buss output signals) output from the CUE OUT jacks (46) can be monitored.

Down position is ON and up position is OFF for these buttons. Also, please note that these two buttons are the LOCK RELEASE type (only one of either button can be pressed).

## 27. MONITOR OUT SELECTOR (MONITOR OUT)

This is for selecting whether 1 (RCA pin jack) or 2 (stereo phone jack) of the MONITOR OUT jack (45) is to be active. As both 1 and 2 are at the same level (-10dBV) and same impedance (10KΩ load), the selection depends on the connector.

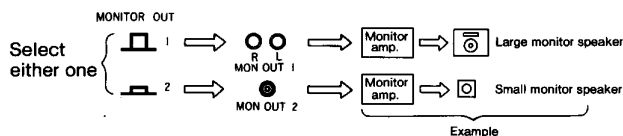

## 28. MONITOR LEVEL KNOB (MONITOR)

Adjusts the output level of the signal output from MONITOR OUT jacks 1 and 2 (45).

## 29. HEADPHONE LEVEL KNOB (PHONES)

Adjusts sound level of the headphones plugged into the PHONES jack (47).

## 30. PREFADER LISTEN/SOLO LEVEL KNOB (PFL/SOLO)

Adjusts the master level of the PFL buss. The total sound volume can be set at solo monitoring by pressing the PFL button (15) or SOLO button.

## 31. CUE MASTER LEVEL KNOB (CUE MASTER)

The CUE buss master level adjusting knob. Output level at the CUE OUT jack (46) can be set. This is convenient for setting the total sound volume when sending to the CUE buss the signals of SUB MIX sections 3 and 4 by the CUE/L-R selector (5).

## 32. 12 POINT LED BARGRAPH METERS

These indicate the output levels, from left to right, at the GROUP OUT jacks 1, 2, 3, 4 (40) and the STEREO OUT jack 1 (43) L, R.

Please note that when at least one PFL button (15) or SOLO button is pressed, the L and R meters will indicate the mixed signal level on the PFL buss.

## 33. XLR INPUT JACKS

These are XLR type balanced input connectors (#3 pin hot) which match signals from mic levels to line levels. They can also match unbalanced type input signals but then pins #1 and #2 must be GND and the PHANTOM POWER switch (35) must be switched OFF at all times. If a plug is inserted into the phone INPUT jack (34), that jack will have priority and the signals to the XLR connector will be by-passed.

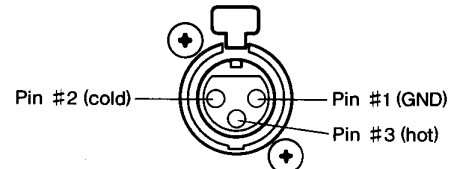

## 34. PHONE INPUT JACKS (INPUT)

These are unbalanced phone jacks which signals from mic levels to line levels. They can, of course, match the balanced line type input signals but then the plug tip must be hot and the ring cold.

## 35. PHANTOM POWER SWITCH (+48V)

The ON/OFF switch for the DC48V phantom power to the microphone. This must always be switched OFF (button up position) when a dynamic microphone is used because it does not require a power supply. When this is switched ON, pin #1 will be 0 volt and DC48 volts will be applied to pins #2 and #3.

## 36. TAPE INPUT JACKS (TAPE)

Normally, the outputs (unbalanced) of a multitrack recorder are plugged in here. These are set for the rated input level of -10dBV (20KΩ) before leaving the production line (Refer to NOTE 1 of the P.O.).

## 37. ACCESSORY SEND/RECEIVE JACKS (SEND/RCV)

These jacks are used for plugging in external sound processors such as digital reverbs, compressors/limiters and noise gates. These are in stereo phone format (TIP is send, RING is receive) and when nothing is plugged in here, the signal will be jumpered from send to receive.

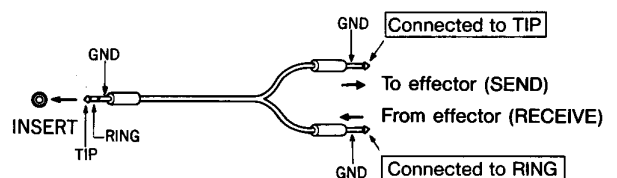

## 38. DIRECT OUT JACK (D. OUT)

The output jacks of the post fader (post equalizer) signals of each channel. These can be used for sends to the effect unit.

## 39. AUX OUT JACKS (AUX OUT 1, 2, 3, 4)

Output jacks of the AUX buss 1 ~ 4. Used for sending the mixed signal of the AUX 1 ~ 4 send (8) to the digital reverb.

#### 40. GROUP OUT JACKS (GROUP OUT 1, 2, 3, 4)

Output jacks of the GROUP buss 1 ~ 4 which are normally used for sends to the multitrack recorder.

#### 41. GROUP IN JACKS (GROUP IN 1, 2, 3, 4)

Input jacks of the GROUP buss 1 ~ 4. Normally, effects returns and outputs of other mixers are plugged in here and used for mixing into the GROUP buss.

#### 42. 2 TRACK IN JACKS (2 TRK IN 1 ~ 2)

Master recorder outputs are normally connected here. Playback of the master tape can be simply monitored by selecting the 2 TRK IN SOLO button 1 ~ 2 (25).

#### 43. STEREO OUT JACK (STEREO OUT 1 ~ 2)

Output jacks of the STEREO buss. These are normally used for sends to the master recorder. Although signals via the STEREO master fader (22) will be sent both to 1 (RCA pin jacks) and 2 (stereo phone jacks), their rated output levels will be  $-10\text{dBV}$  at 1 (RCA pin jacks) and  $+2\text{dBV}$  ( $+4\text{dBs}$ ) at 2 (stereo phone jacks), and either level can be chosen for your particular application.

The polarity of 2 (stereo phone) is L for the TIP and R for the RING.

#### 44. STEREO IN JACK (STEREO IN)

Input jacks of the STEREO buss. These jacks are used to connect the stereo outputs of another mixer or effects returns for mixing into the STEREO buss.

#### 45. MONITOR OUT JACKS (MON OUT 1 ~ 2)

The signal selected by the MONITOR selector (26) is output here via the MONITOR level knob (28). If at least one PFL button (15) or SOLO button is pressed, the PFL buss output signal (the signal passing through the PFL/SOLO level knob (30)) will be the output here via the MONITOR level knob (28).

In this function, only one of either 1 (RCA pin jack) or 2 (stereo phone jack) will be effective (Refer to MONITOR OUT selector (27)).

The polarity of 2 (stereo phone) is L for the TIP and R for the RING.

#### 46. CUE OUT JACK (CUE OUT)

The output jacks of the CUE buss. The mixed signal of the SUB MIX sections (3), (4) can be this output via the CUE master level knob (31). This mix is a convenient monitor/cue for the musicians.

#### 47. HEADPHONE JACK (PHONES)

The same source at MONITOR OUT jacks 1 ~ 2 is the output here.

#### 48. PREFADER LISTEN/SOLO INDICATING LED (PFL/SOLO)

This will be lit when at least one of the PFL button (15), SOLO buttons (16), (19), (24), or (25) is pressed. While this LED is lit, the PFL buss output signal will be sent to the MONITOR OUT jacks 1 ~ 2 (45) and the PHONES jack (47), and the mixed signal of the PFL buss will be indicated on the L, R sections of the meter (32).

#### 49. POWER LED (POWER)

This is lit when power is applied to the POWER supply connector (50).

#### 50. POWER SUPPLY CONNECTOR (POWER)

#### \* NOTE 1: THE TAPE TRIMMER

This trimmer is for matching the input level of this unit's TAPE IN jack (36) with a recorder whose output level is other than  $-10\text{dBV}$ .

Although its variable range is  $-16\text{dBV} \sim +20\text{dBV}$ , it is adjusted to  $-10\text{dBV}$  at leaving the plant and Fostex multitrack recorders such as Model E-16, E-8 and 80 can be connected without any adjusting.

## SECTION 3. CONNECTIONS WITH EXTERNAL EQUIPMENT

### 1. IMPEDANCE

Input and output impedances should always be considered when connecting this unit to other equipment.

Impedance is the resistance value against alternating currents such as sound signals and the unit of measurement is  $\Omega$  (Ohm). If the output impedance of a given unit does not match the input impedance of the other, sound distortion or even equipment breakdown could occur. In general, the rule is that output impedance should be low (low out) and input impedance should be high (high receive). Refer to SPECIFICATIONS in page 19 for input/output impedance of this unit.

**NOTE:** Always use a Direct Box when interconnecting outputs indicated in watts, (W) such as that of a power amplifier, with a high impedance input. If this precaution is not followed, severe damage may result.

### 2. LEVEL MATCHING WITH EXTERNAL EQUIPMENT

Matching the level of the external equipment connected to the INPUT jacks (33) and (34) of this unit is done by the TRIM (1) controls. Adjust so that the PEAK LED (6) does not frequently flash on the signal peaks. As noise and distortion is the least in the range of  $0 \pm 5$  (dB) of the INPUT faders (17), it is recommended to preset them within this range, then adjust the level with TRIM (1). During this operation, if the PFL button (15) and INPUT SOLO button (16) are pressed in advance, the prefader and post-fader levels and tone can be conveniently checked. However, as the PEAK LED (6) will be lit during overloading at EQ (7), each gain of EQ (7) should be kept flat when adjusting TRIM (1). After setting TRIM (1), if the PEAK LED should be lit during testing of the tone by EQ (7), there is overloading at the EQ stage (7) and the corresponding gain should be decreased, or re-adjust TRIM (1).



In regards to level matching of external equipment TAPE IN jack (36) of this unit, refer to NOTE 1: TAPE Trimmer, page 7.

As inputs other than the above and all outputs are at the rated level of  $-10\text{dBv}$  (0.3V) except for STEREO OUT jack 2 (43), the outputs will thus be

low impedance sends and therefore can be connected to all Fostex recording equipment and personal studio equipment. On the other hand, it may be necessary to use an attenuator and line amplifier (Fostex Model 5030, etc.) when connecting to equipment with different  $+4\text{dBm}$  rated input/output levels.

## SECTION 4. PARAMETRIC EQUALIZER

A fixed frequency 10KHz shelving type equalizer and a 2 band parametric equalizer which covers different frequencies are provided at each input channel of this unit. The two parametric equalizers can, respectively, be set at any frequency within the ranges of 60Hz ~ 1KHz and 400Hz ~ 6KHz. It is possible of boost or cut in the  $\pm 15\text{dB}$  range, and will be highly effective in adding character to the tone by allowing control of the fundamental frequency and harmonic overtones which determine the timbre of musical instruments and the human voice.

**NOTE:** Although the parametric equalizer is highly effective in correcting mistake in the original sound, during microphone recording, it is important to try changing mic positioning or using another type of mic to obtain the desired timbre before relying on the equalizer.

Sound range of various musical instruments

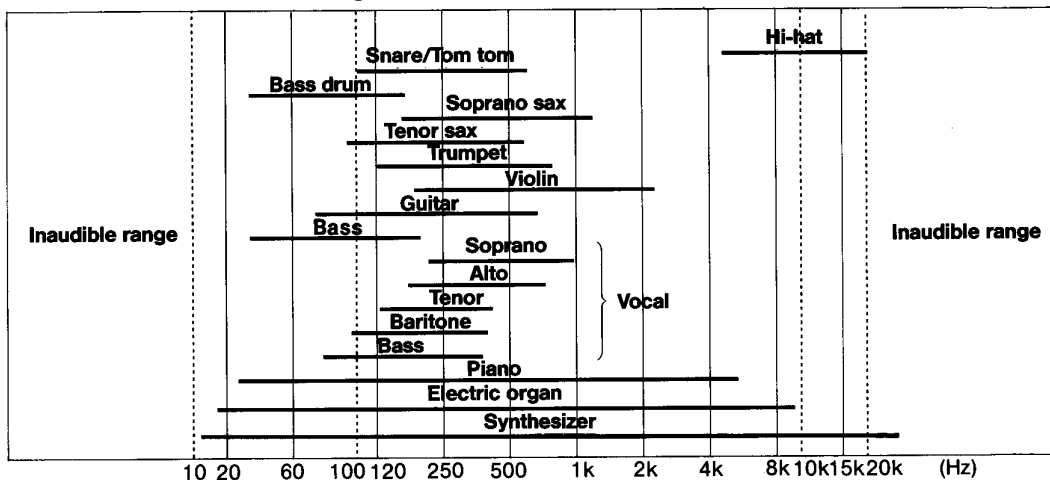

### TYPICAL EQUALIZATION RESPONSE GRAPH

INSTRUMENT	CUTTING	BOOSTING
Human Voice	Scratchy at 2kHz Nasal at 1kHz Popping p's below 80Hz	Hot at 8 or 12kHz Clarity above 3kHz Body at 200 - 400Hz
Piano	Tinny at 1 - 2kHz Boomy at 320Hz	Presence at 5kHz Bass at 125Hz
Electric Guitar	Muddy below 80Hz	Clarity at 3.2kHz Bass at 125Hz
Acoustic Guitar	Tinny at 2 - 3.2kHz Boomy at 200Hz	Sparkle above 5kHz Full at 125Hz
Electric Bass	Tinny at 1kHz Boomy at 125Hz	Growl at 620Hz Bass below 80Hz
String Bass	Hollow at 620Hz Boomy at 200Hz	Slap at 3.2 - 5kHz Bass below 200Hz
Snare Drum	Annoying at 1kHz	Crisp above 2kHz Full at 125Hz Deep at 80Hz
Bass Drum	Floppy at 620Hz Boomy below 80Hz	Slap at 3.2 - 5kHz Bass at 80 - 125Hz

- Depth of sound by controlling frequency around 100Hz
- Add character by controlling frequency around 1kHz
- Voluminous sound by boosting 2 ~ 4kHz
- Clarity by boosting around 6kHz
- Sound brilliancy by boosting above 8kHz

## SECTION 5. INTERCONNECTIONS WITH VARIOUS PROCESSORS

Numerous varieties of processors such as digital reverb and delay, compressor/limiter and noise gates are indispensable tools of music production in recent years. The Series 40 units are provided with inputs and outputs convenient for connecting these processor such as AUX OUT jack 1 ~ 4 (39), SEND/RCV jack (37), D.OUT jack (38), GROUP IN jack 1 ~ 4 (41), etc.

Among these, the 1 and 2 AUX OUT jack (39) can be selected for pre-fader mix or post-fader mix and either can be chosen according to the application. The GROUP IN jacks 1 ~ 4 (41) and STEREO IN jacks (44) are

normally used for effects returns but if there are more returns, it will be easier to feed all of these to another mixer before returning them.

Also, even though all INPUT faders (17) are in use at the multitrack recorder outputs, the input signals at the INPUT jacks (33) and (34) can be stereo mixed in the SUB MIX sections (3) and (4) by the alternate change function, and therefore, by patching the effects outputs to the INPUT jacks (33) and (34), the same number of returns as input channels can be sent to the master recorder.

Actual connections are shown in the following examples:

**Fig. 1 USING INDIVIDUAL PROCESSORS AT EACH INPUT CHANNEL**

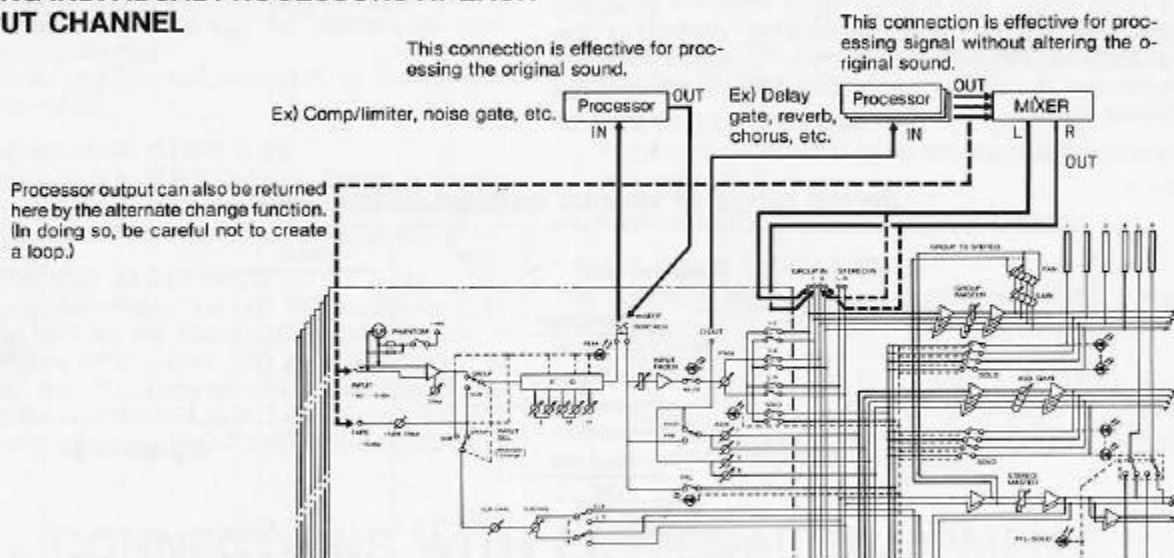

**Fig. 2 USING A PROCESSOR COMMON TO ALL INPUT CHANNELS TO SEND RETURNS IN INDIVIDUAL AMOUNTS AND PERSPECTIVES TO EACH CHANNEL.**

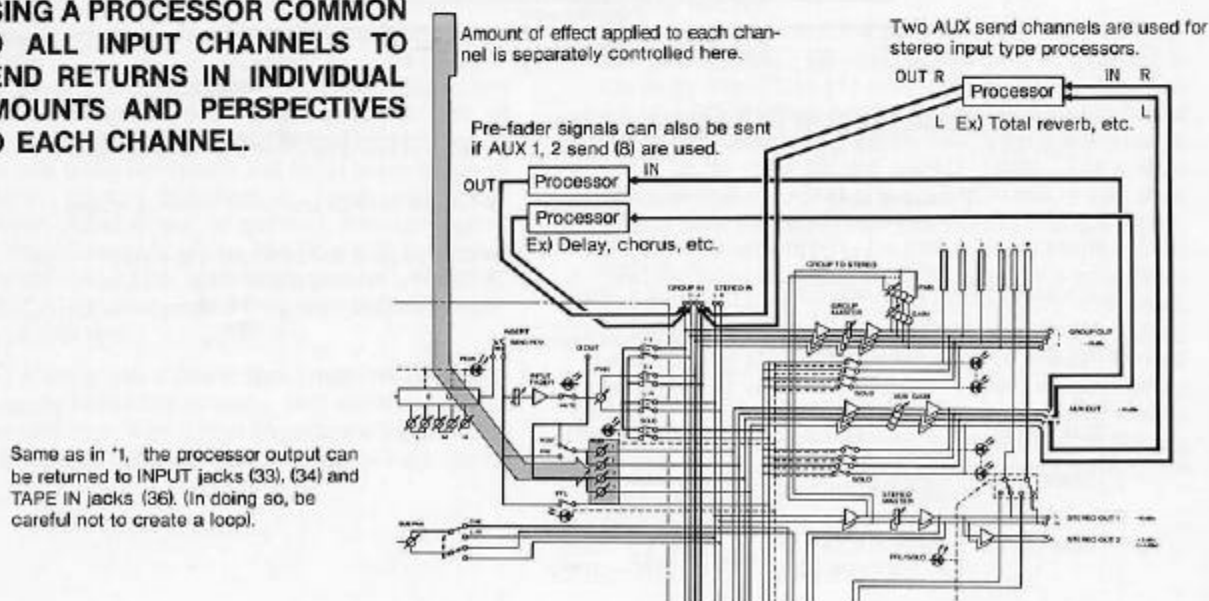

## SECTION 6. MULTITRACK RECORDING

Models 1240/1840/2440, with Fostex Models E-16, E-8 and 80, completely support all processing stages of multitrack recording.

A representative example of multitrack recording by a combination of the Model 1840 and Fostex E-16, is explained in the following.

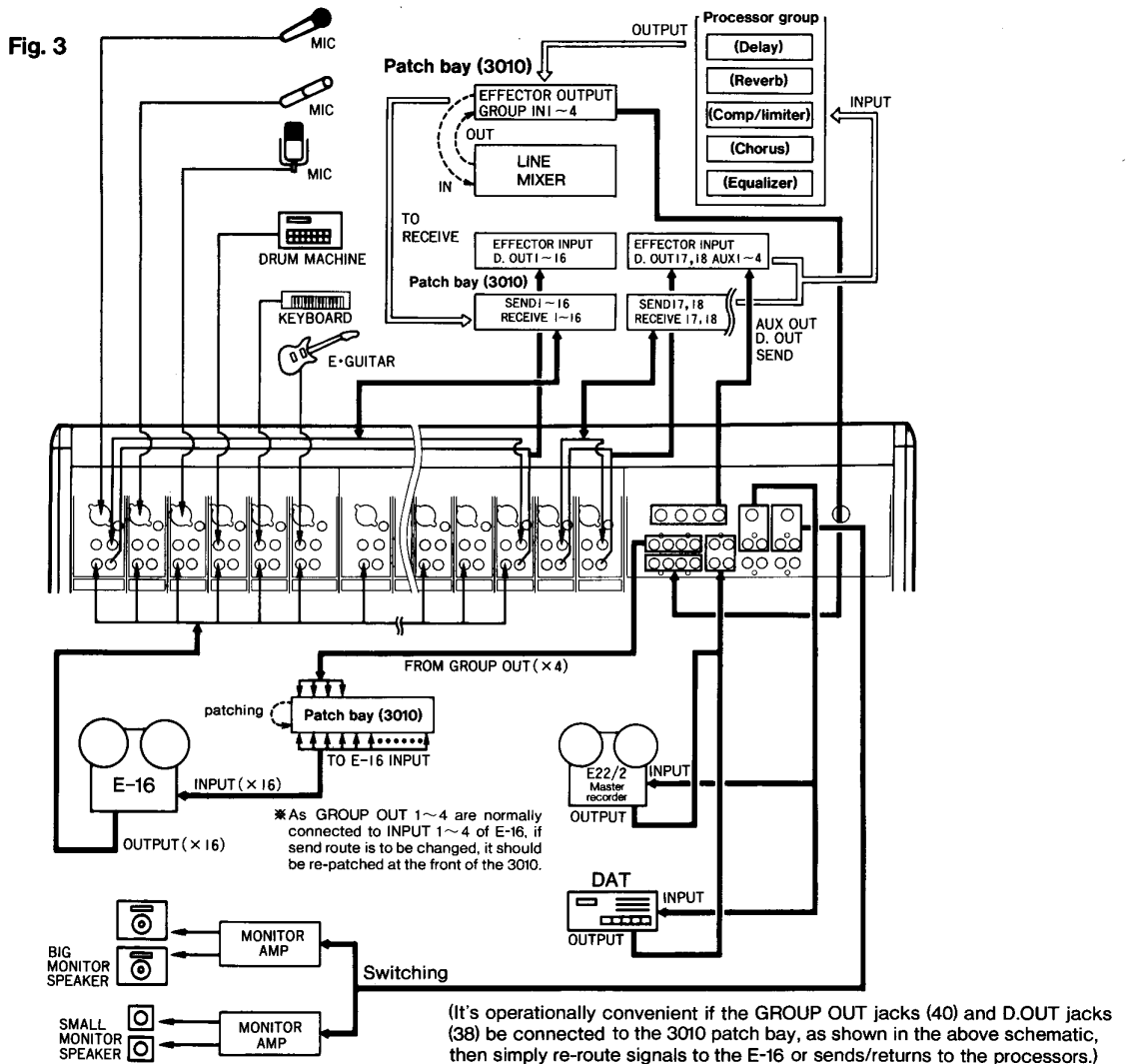

**NOTE:** Models 1240/1840/2440 have four channels of group outputs. The most convenient set-up with multitrack recorders is via a patch bay like the 3010 and route the signals by patching them at the front of the 3010, but care must be exercised in the following points.

**E-16:** In the E-16, INPUTS 9 ~ 16 are normalised jacks wired in parallel with INPUTS 1 ~ 8. In other words, if nothing is plugged into jacks 9 ~ 16, the same signal is sent to channels 1 and 9, 2 and 10, ... 8 and 16. If this feature is to be utilized, you need only connect INPUTS 1 ~ 8 to the 3010 patch bay.

**E-8 & Model 80:**

As INPUTS 5 ~ 8 are normalised jacks wired in parallel with INPUTS 1 ~ 4 in this recorder, you need not use the 3010 the same way as with E-16. The GROUP OUT buss signal of this unit (Models 1240/1840/2440) can be recorded on any track

of the E-8 (Model 80) if the GROUP OUT jacks 1 ~ 4 (40) are directly connected to INPUTS 1 ~ 4 of the E-8.

However, if you wish to record on more than five tracks in one pass, either use the STEREO OUT jack 1 (43) in parallel with the recorder send (in this case, six tracks can be recorded), or if more sends are required, it is recommended to use D.O.U.T jacks (38) in parallel.

It is possible to also use the CUE OUT jack (46) but in this case, while sending input signals from INPUT jacks (33) and (34) to SUB MIX sections (3) and (4) by setting the GROUP/SUB selector (2) to SUB, you must set the CUE/L-R selector (5) to CUE and send the input signal to the CUE OUT jack (46) (In this case, 8 track recording is possible without using the D.O.U.T jack (38) but tone adjusting by EQ (7) is not possible).

In either case, be extremely careful to prevent forming a feedback loop.

## I RECORDING OF THE BASIC TRACK

### What is the basic track?

In multitrack recording, the first step is usually the Rhythm track and consists of an combined unit of important parts which determine the outline of the music. This "Rhythm track" is also called the "Basic track".

### NOTES BEFORE OPERATING

In the operating example of Fig. 1, the STEREO buss is also used for sending signals to the recorder. If recording work is to be started by this method, you should always first **set all CUE/L-R selector (5) to CUE** to prevent a feedback loop. For the same reason, **set all GROUP/SUB selectors (2) to GROUP**.

Please refer to Fig. 4. This is an example of separately recording seven tracks in one pass. It is the method of picking up sounds such as dram, electric base, electric guitars by a multiple number of microphones and recording these in one pass on tracks 1 ~ 7 of E-16. After completing level matching and timbre of each sound source (Refer to page 7, "2. Level Matching With External Equipment" and "THE PARAMETRIC EQUALIZER," page 8.) note the settings for sending these signals to the E-16.

### E-16 TRACK CHART

TRK	1	2	3	4	5	6	7
SOURCE	EB (Elec. base)	KICK (Bass drum)	SD (Snare drum)	HI-HAT (hi- hat)	L-----R TOM RIDE CRASH		EG (Elec. guitar)

### Procedure 1

Following is the procedure for assigning each sound source to each track.

**TRK 1:** As the signal from GROUP OUT jack 1 (40) is routed to TRK 1, EB plugged into the channel 17 INPUT fader (17) (GROUP/SUB selector (2) → GROUP) is routed to GROUP buss 1 (ASSIGN 1-2 switch (10) → ON, PAN (13) → ODD). Then, for setting level of the GROUP buss 1 signal going to the GROUP OUT jack 1 (40), the GROUP master fader 1 (18) is adjusted (can be checked by 1 of meter (32) 1). Be sure, however, that GROUP TO STEREO GAIN 1 (20) is set to full - ∞ to prevent this signal from being applied to the STEREO buss and recorded on tracks 5 and 6.

**TRK 2:** In the same way as for TRK 1, the channel 1 KICK is sent to the GROUP buss 2 at the setting in the schematic. Setting of the send level by the GROUP master fader 2 (40) (checking by the meter 2 (32)) and fully retarding the GROUP TO STEREO GAIN 2 (20) is the same as above.

**TRK 3:** TRK 4: Same procedure as for TRK 1 and 2.

**TRK 5:** TRK 6: As GROUP buss 1 ~ 4 are all in use, the STEREO buss is used for sends to TRK 5 and TRK 6. As shown in the schematic, STEREO OUT jack 1 (43) is patched to INPUT 5 (←L) and

6 (←R) of the E-16.

TOM (x2), RIDE, CRASH are mixed in stereo perspective and recorded on TRK 5 and 6. Each sound source is sent to the STEREO buss by setting the channel 4 ~ 7 assign L-R switch (12) to ON and PAN (13) to the setting shown in the schematic, and send level to the recorder adjusted by the STEREO master fader (22). The level can normally be confirmed by L and R of the meter (32) but please note that it will indicate the PFL buss mixed signal level when the PFL/SOLO LED (48) is lit.

**TRK 7:** EG send to TRK 7 is done by patching the DOUT jack (38) to the E-16 INPUT 7. Assign switches (10), (11), (12) are switched OFF to prevent the EG sound to be recorded on other tracks. Also, the send level is adjusted by the channel 18 INPUT fader (17) (Dotted lines in the schematic).

### Procedure 2

In general, there are two methods of monitoring.

**Method 1:** Listen to the sound to be sent to the recorder (input).

**Method 2:** Listen to the sound returned from the recorder (tape).

In the example of Fig. 1, monitoring is by Method 2 but Method 1 will be explained first (It is recommended to normally monitor by Method 2).

### [Method 1]

The solo monitor function of this unit is a straight stereo format (Fixed to center perspective for PFL function and AUX & GROUP solo function): the signals can be control (There could be differences in sound volume balance of each sound source and the balance of that actually sent to the recorder, depending on the GROUP and STEREO master fader (18) and (22) settings.), if the INPUT SOLO buttons (16) of channels 1 ~ 7, 17, 18 are pressed with the PFL/SOLO level knob (30) advanced.

On the other hand, if the GROUP buss 1 ~ 4 only is used for sends to the recorder, it can be monitored at the same sound volume balance (only at center perspective) as that being sent, by pressing the GROUP SOLO buttons 1 ~ 4 (19).

### [Method 2]

To monitor the recorder output, normally, the SUB MIX sections (3) and (4) are used as shown in Fig. 1. If this method is used, the sound can be monitored at any sound volume and perspective without regards to the recording level of each track, thus it's advantage over the previous Method 1.

In the E-16 (E-8, Model 80), signals applied to the inputs are also heard at the outputs of the track in the recording mode (= INPUT MONITOR). In addition, regardless of whether it is to be recorded or not, the specified track can be set to input monitor and tracks other than this to tape monitor (= tape sound sync playback) by the INDIV., input monitor function. In either case, the example in Fig. 1 shows mixing of the E-16 TRK 1 ~ 7 output signals in the SUB MIX sections (3) and (4).

The E-16 TRK 1 ~ 16 outputs (OUTPUT 1 ~ 16) connected to the TAPE IN jacks (36) are already routed

to SUB GAIN (3) of channels 1 ~ 16 selection of the GROUP/SUB selector (2) in the schematic, but as the output of TRK 1 ~ 7 are to be monitored here, all SUB GAIN (3) other than channels 1 ~ 7 must be set to  $-\infty$ . Set MONITOR selector (26) to CUE to allow listening to the CUE buss sound (this is because sounds of TOM, etc. are already on the STEREO buss), and set all CUE/L-R selector (5) to CUE (to prevent creating a loop). By this setup, the total sound can be adjusted by the CUE master level knob (31), and each sound volume and perspective for TRK 1 ~ 7 can be adjusted by the channel 1 ~ 7 SUB MIX sections (3) and (4). In this example, the SUB PAN (4) is set with consideration to the perspective plan at mixdown (Raise the MONITOR level knob (28) when using the monitor speaker, and the PHONES level knob (29) for monitoring with the headphones.)

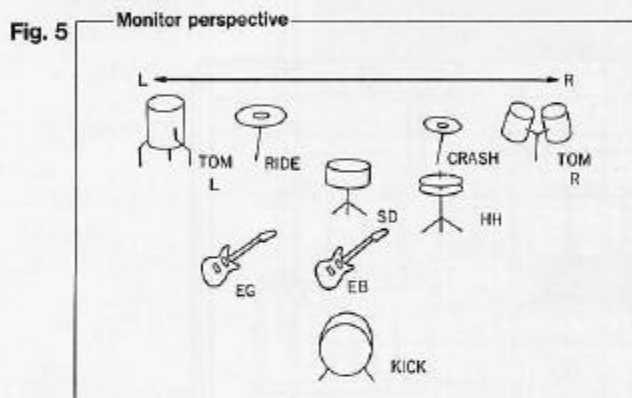
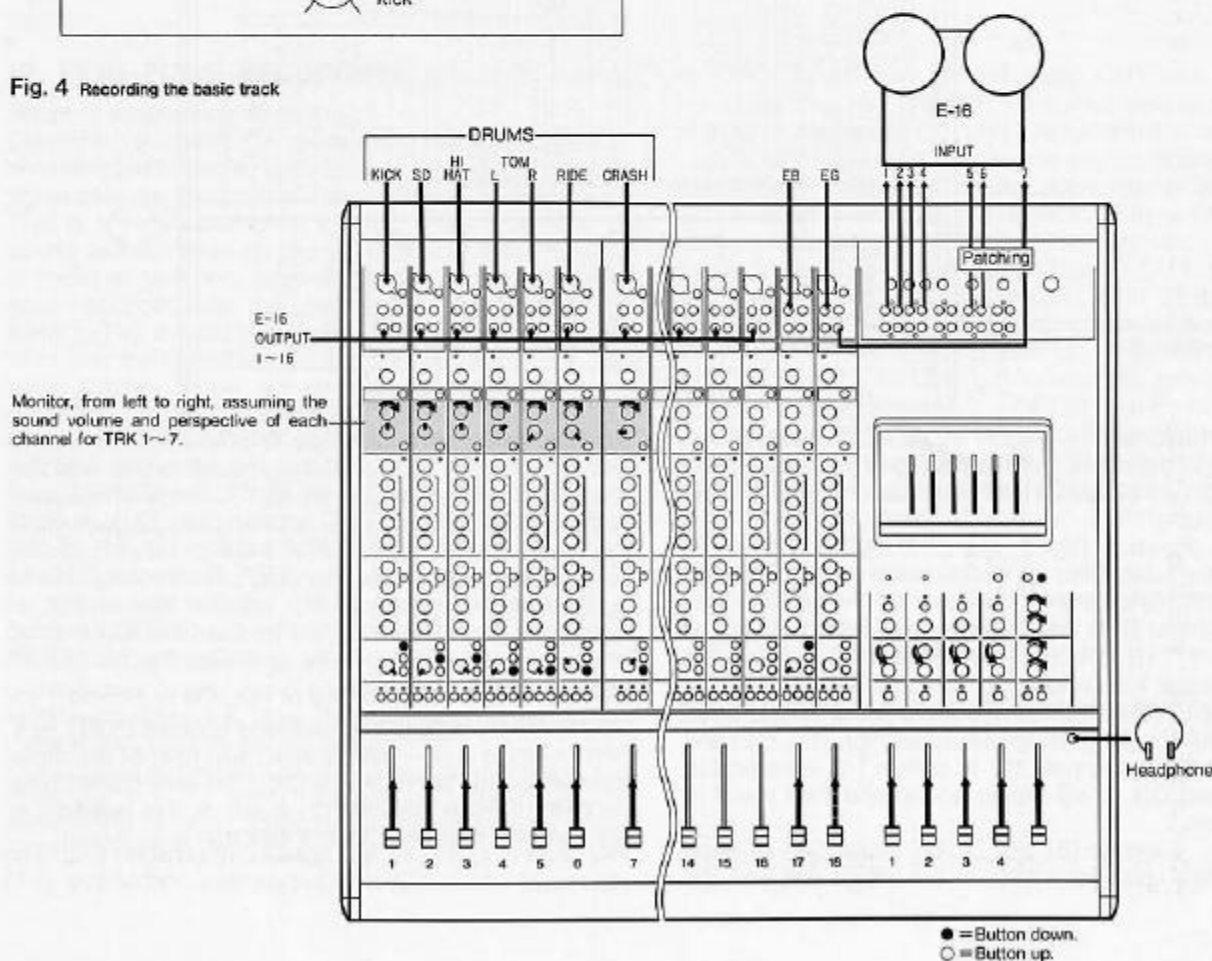

Fig. 4 Recording the basic track



## RECORDING WITH ADDED EFFECTS

In the example of Fig. 1, the monitored sound was "dry" (raw sound with no effects added), but it is often desired to record on the assumption that effects will be added (or effects sound sent to the monitor system only without recording on tape) later at mixdown. For example, if SD and others are to be monitored with reverb added, it could be done as follows.

1. The sound source signals are sent to the reverb unit using the AUX 1 ~ 4 sends (8) of the channel (channel 2 if it is SD) on which reverb is to be added. (Refer to "INTERCONNECTION WITH VARIOUS PROCESSORS", page 9.)
2. Return the reverb output to the INPUT jacks (33), (34) of an open channel (such as channels 15, 16) and send it to the SUB MIX section (3), (4) (GROUP/SUB selector (2) → SUB). Then, set CUE/L-R selector (5) to CUE, set the total sound volume by SUB GAIN (3), set the perspective by SUB PAN (4) and send it to the CUE buss for monitoring.



## II OVERDUBBING

### What is overdubbing?

Recording of another source on a new separate track while monitoring in sync playback the track of a pre-recorded sound is called "overdubbing."

Refer to Fig. 6. This is an example of overdubbing a synthesizer (SYN) on TRK 15 and a vocal (VO) on TRK 16 while sync playback monitoring the pre-recorded TRK 1 ~ 14 (Refer to the recorder's Owners Manual on functions of the REC TRK selector, etc.).

First, connect sound sources to be newly recorded to INPUT jacks (33) and (34) (channels 1 and 2, in this example), and set all the GROUP/SUB selector (2) to GROUP. Then, the various sound sources routed to the

INPUT faders (17) are sent to the buss (in this example, SYN → GROUP buss 1 → TRK 15, VO GROUP buss 2 → TRK 16) and are used for sends to the recording tracks by the assign switches (10), (11), (12) and PAN (13). Also, send level to the recorder is adjusted by the master fader (here, GROUP master fader 1, 2 (18)) of the corresponding buss, while checking the level with the meter (32).

Monitoring is done at the SUB MIX section (3), (4). Sound volume and pan perspective of each track can be freely set (it will not affect the recording level). In this example, we are sending the TRK 1 ~ 16 output signals to the CUE buss by setting all channels 1 ~ 16 CUE/L-R selectors (5) to CUE, then monitoring via the CUE master level knob (31) (MONITOR selector (26) → CUE).

Fig. 6 Overdubbing

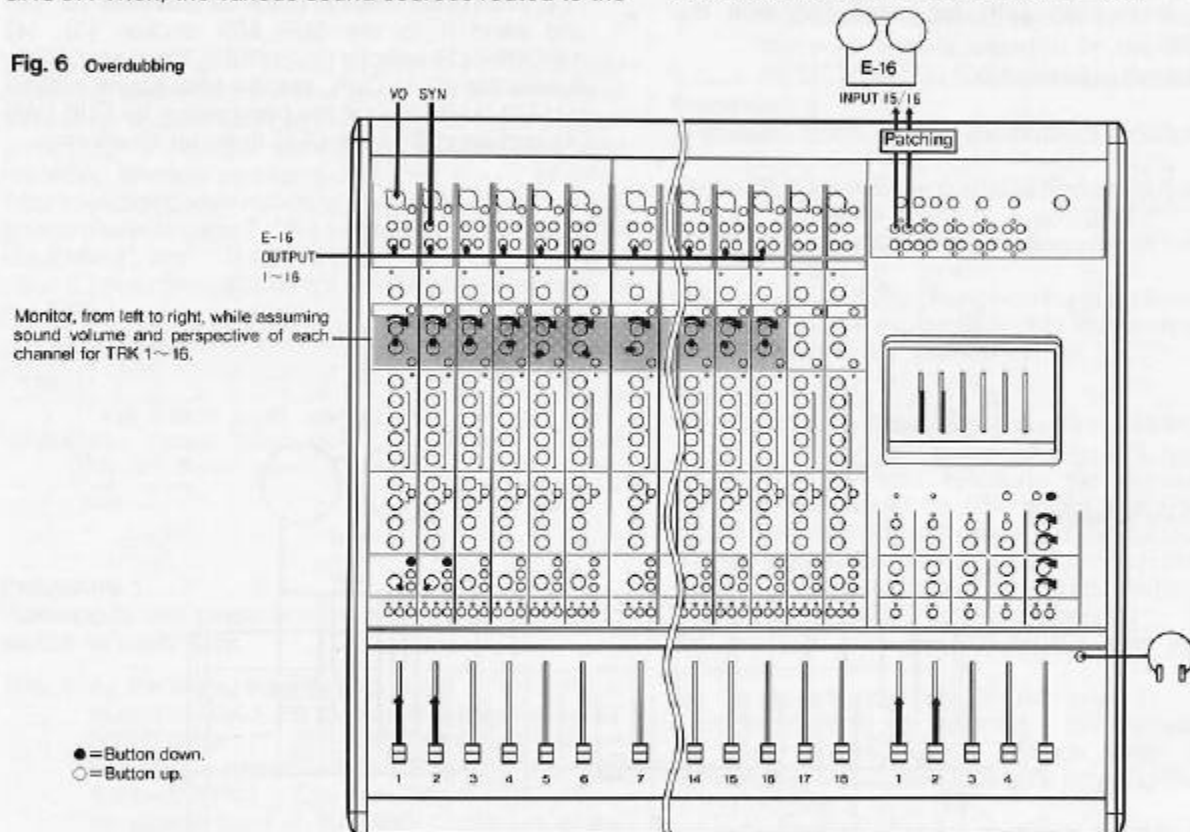

### MONITORING DRY — EFFECTS ADDED LATER.

Following is the method of monitoring on the assumption that effects will be added later at mixdown to the recorder output sound.

First, as shown in Fig. 7, the E-16 OUTPUT 1 ~ 16 signals are connected to the channels 1 ~ 16 INPUT faders (17) (GROUP/SUB selector (2) → SUB).

Then, VO and SYN are connected to INPUT faders of channels 17, 18 (GROUP/SUB selector (2) → GROUP). GROUP buss 1, 2 are used for sends to TRK 15, 16 and the signal to be monitored is sent to the STEREO buss (Be careful in setting assign switches (10), (11), (12) and PAN (13). If the channels 15, 16 assign 1-2, in particular, is switched ON, it will create a loop and thus result in feed backs.).

AUX 1 ~ 4 sends (8) and D.OUT jacks (38) of each channel are used for sends to the effect unit and the

effect outputs are returned to the GROUP IN jacks 3, 4 or INPUT jacks (33), (34) that are not in use; and the sound of GROUP buss 3, 4 are sent to the STEREO buss by the GROUP TO STEREO section (20), (21); or send the effect sound of SUB MIX section (3), (4) to the STEREO buss by setting the CUE/L-R selector (5) to L-R. Total sound volume of the monitor (dry sound + processed sound) is adjusted by the STEREO master fader (22) and monitored by selecting the MONITOR selector (26) to STEREO.

**NOTE:** When making a connecting such as D.OUT jack (38) → effect unit → INPUT jack (33), (34) of the same channel (or the TAPE IN jack (36)), be very careful how the GROUP/SUB selector (2) is set. In this example, it will create a feedback loop if GROUP is selected.

Fig. 7 Overdubbing (Assuming effect processing)

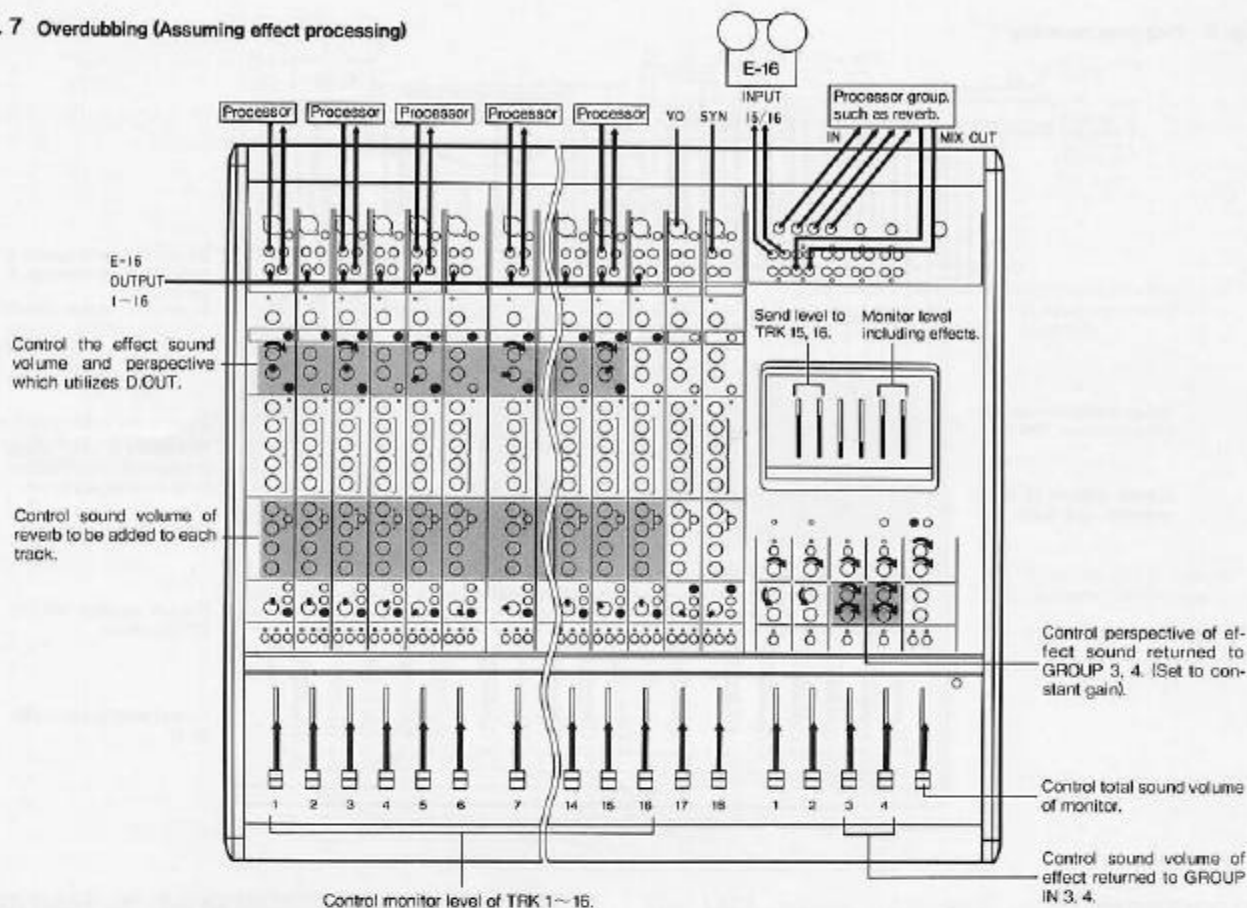

### III. PING-PONG RECORDING

#### What is ping-pong recording?

Combining the playback sounds of a multiple number of pre-recorded tracks by a mixer, then recording the mixed signal onto another track is called "ping-pong recording." This is a very convenient method when a number of sound sources must be recorded onto a limited number of tracks as ping-pong recording allows overdubbing new sound sources over the old tracks.

Refer to Fig. 8. This is an example of stereo mixing with this mixer the output signals of the E-16 TRK 1 ~ 7 (the basic tracks of the above example) and ping-pong recording on TRK 15 and TRK 16.

GROUP buss 1 and 2 were used for sends to the recorder at overdubbing (Refer to Fig. 2) but here, let's consider using the STEREO buss. The GROUP buss, of course, can be used but as more input sources can be mixed by using the STEREO buss, this is especially advantageous during ping-pong recording. The reason for this is in the fact that sounds which have been ping-pong recorded cannot be separately processed at mixdown. Consequently, when ping-pong recording, it is necessary to process the tracks before they are sent to the recording track. Thus, the buss which allows mixing more effect returns will be better.

First, output signals of TRK 1 ~ 7 are connected to the channels 1 ~ 7 INPUT faders (17) (GROUP/SUB selector (2) → SUB). Then, these signals are sent to the STEREO buss by the assign L-R switch (12) and PAN (13), and further, sent via the STEREO master fader (23)

to TRK 15, 16 from the STEREO OUT jack 1 (43). For monitoring the TRK 15, 16 output signals are sent to SUB MIX sections (3), (4) (GROUP/SUB selector (2) → GROUP), and the CUE buss is monitored by setting the CUE/L-R selector (5) to CUE (CUE master level knob (31) → raise level; MONITOR selector (26) → CUE). For effect processing, D.OUT jack (38) and AUX 1 ~ 4 sends (8) are used. The returns from D.OUT jack (38) is connected to INPUT jacks (33), (34) of the same channel, sound volume and perspective determined at the SUB MIX sections (3) and (4), then sent to the STEREO buss by the CUE/L-R selector (5). Effect returns from the AUX OUT jacks 1 ~ 4 (39) are connected to the channels 15 ~ 18 INPUT jacks (33) and (34), each sound volume adjusted by the INPUT fader (17), the perspectives set by the assign L-R switch (12) and PAN (13), then sent to the STEREO buss. Effect sound timbre is adjusted by EQ (7).

When ping-pong recording by this method, be careful in selecting the GROUP/SUB selector (2) for channels 1 ~ 7 and 15, 16, in addition to precautions in the schematic. If these selections are made in reverse, it will create a loop between the effect IN/OUT and between IN/OUT of TRK 15, 16, and could result in feedback.

Fig. 8 Ping-pong recording

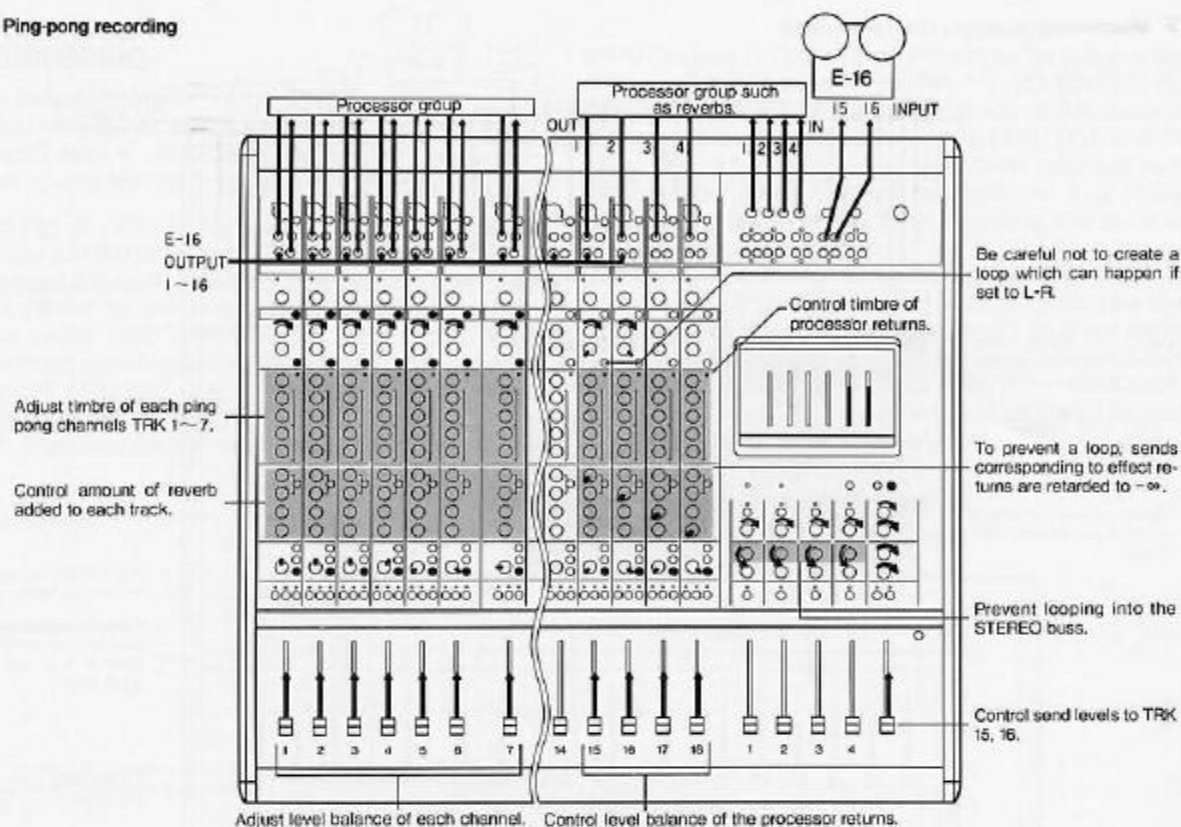

#### IV. MIXDOWN

##### What is mixdown

After finishing all recording on the multitrack recorder, combining into stereo (or monaural) the playback sound of all tracks thru the mixer, then copying it onto a master tape is called "mixdown." This is an important operation in which the final touches are made to the multitrack recording, and is carried out in parallel, from equalization to effect processing, for total sound creation.

Please refer to Fig. 9. This is an example of applying various effects on the playback sound from the E-16 TRK 1 ~ 16, mixing it to stereo, sending it to the master recorder together with the dry sound and mixing it down. Each track can be classified into two types according to the types of source signals which are respectively combined in stereo in the GROUP buss 1 & 2 and 3 & 4 (= Grouping. Refer to GROUP master fader 1 ~ 4 (18)).

The output signals TRK 1 ~ 16 routed to the INPUT fader (17) by the channel 1 ~ 16 GROUP/SUB selector (2), are grouped to the GROUP master fader 1 ~ 4 (18) by the assign 1-2, 3-4 switches (10), (11), then sent to the STEREO buss via the GROUP TO STEREO sections (20) and (21). When equalizing each individual track, it will be convenient if the PFL/SOLO level knob (30) is raised in advance, and set to solo monitor by pressing the PFL button (15) or INPUT SOLO button (16). It is also possible to solo monitor the mixed signal that are grouped (in this example, the vocals and backings) by the GROUP SOLO button (19). Further, set the GROUP TO STEREO GAIN 1 ~ 4 (20) to "0" so that these signals are sent to the

STEREO buss at the level same as with the meter (32) 1 ~ 4 indications.

The effect processing method is almost the same as with the ping-pong recording example but please note that the effect returns from AUX OUT jacks 1 ~ 4 are also connected to the channels 17, 18 TAPE IN jack (36) and the STEREO IN jack (44). Especially, it will be safer to select an effect, to be connected to the STEREO IN jack

(44), which is of stereo output and adjustable in output level and perspective. Also, do not forget to set the channel 17, 18 AUX 2 send (8) to  $-\infty$  (same reason as for ping-pong recording). In any case, if the effect sound of SUB MIX section (3), (4) is sent to the STEREO buss by CUE/L-R selector (5), and the effect sound of channel 17, 18 INPUT fader (17) to the STEREO buss by the assign L-R switch (12) and PAN (13), all effect sounds and dry sounds will be sent to the master recorder via the STEREO master fader (22).

For the method of monitoring, you can listen to either the signal sent to the master recorder by selecting STEREO of the MONITOR selector (26) or you can listen to the master recorder output signal by pressing the 2 TRK IN SOLO button 1 (25).



Fig. 9 Mixdown

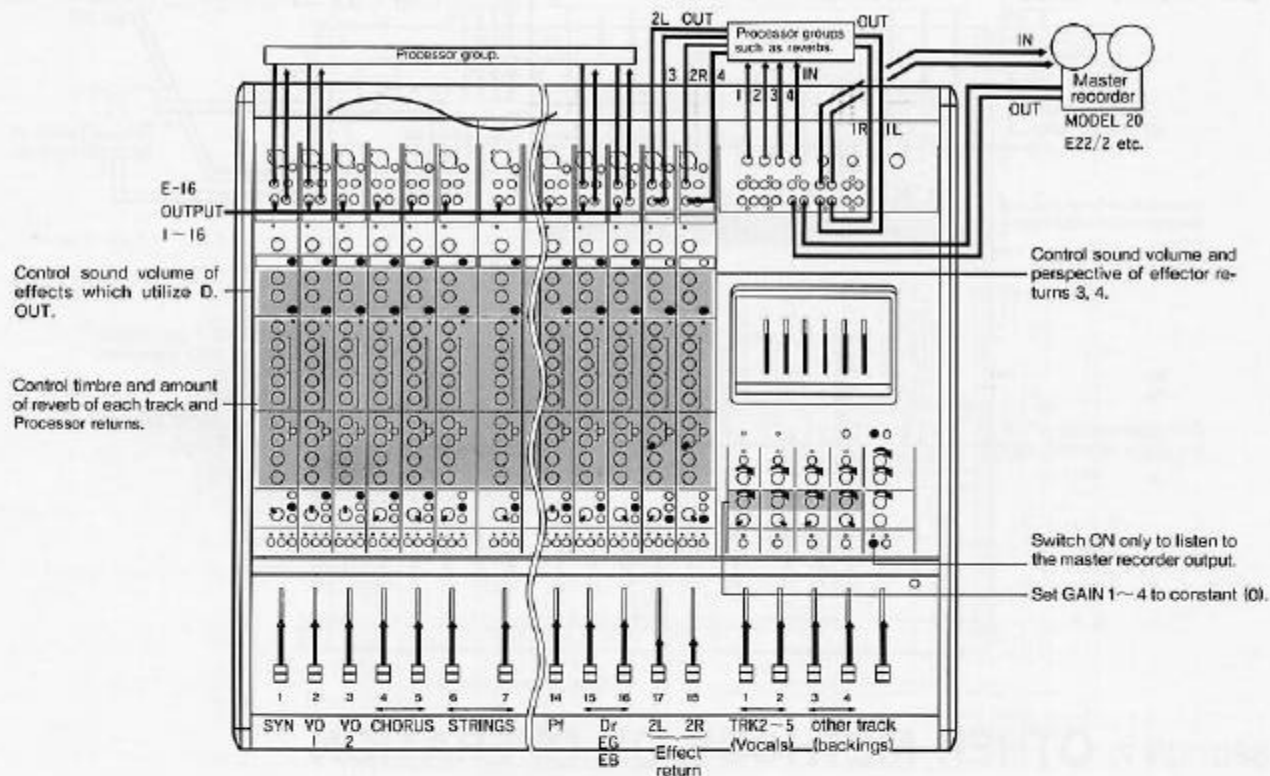

### MIXDOWN BY SYNCHRONIZING WITH MIDI EQUIPMENT

Recording a synchronizing signal such as the SMPTE time code on an edge track of a multitrack recorder, converting this playback signal to MIDI information by an interface unit (Fostex 4050), and sending it to a MIDI sequencer for sync playback of tape, is a technique often used.

As auto performance of the MIDI sequencer will sync with the raw performance of a tape, you can save on tracks as there will be no need to record synthesizers and drum machines on tape; but then, many channels will be required in the mixer (number of tracks + number of MIDI sound source outputs).

The alternate change function of this unit will be of great advantage when conducting such tape sync and mixdown operations.

Please refer to Fig. 10. This is an example of mixing down by sending to the STEREO buss the playback sound of the E-16 TRK 1 ~ 15 (TRK 16 is used for the time code) and the MIDI musical instrument output in sync with it. In the example of Fig. 5, the tape sound was grouped, but here, the CUE OUT jack (46) is patched to the STEREO IN jack (44). The signals will be separately handled as tape and effect sound, and the MIDI musical instrument sound.

The TRK 1 ~ 15 output signals and the effect returns from the AUX OUT jacks 1, 2, 3 (39) are all sent to the STEREO buss via the INPUT fader (17). Also, the effect returns from D.OUT jack (38) and AUX OUT jack 4 (39) are sent to the STEREO OUT buss via the GROUP master faders 1 ~ 4 (18) and the GROUP TO STEREO sections (20), (21) (GROUP TO STEREO GAIN 1 ~ 4 (20) → 0).

The MIDI musical instrument output signals are all connected to the SUB MIX sections (3), (4) and sent to the CUE buss by CUE/L-R selector (5). Total sound volume of the CUE buss mixed signal is set by the CUE master level knob (31) and patched from the CUE OUT jack (46) to the STEREO buss.

If this method is used, a highly efficient operation is possible because it is only necessary to set the CUE master level knob (31) to  $-\infty$  when you wish to listen to the tape and effect sounds only, and when you wish to listen only to the MIDI musical instrument sound, you need only to select CUE by the MONITOR selector (26). In this example, you cannot equalize and effect process the MIDI musical instruments but this will become possible if the GROUP/SUB selector (2) are all set to GROUP (in this case, equalizing and effect processing cannot be done on TRK 1 ~ 15 and effect returns 1 ~ 3).

Fig. 10 Tape sync mixdown

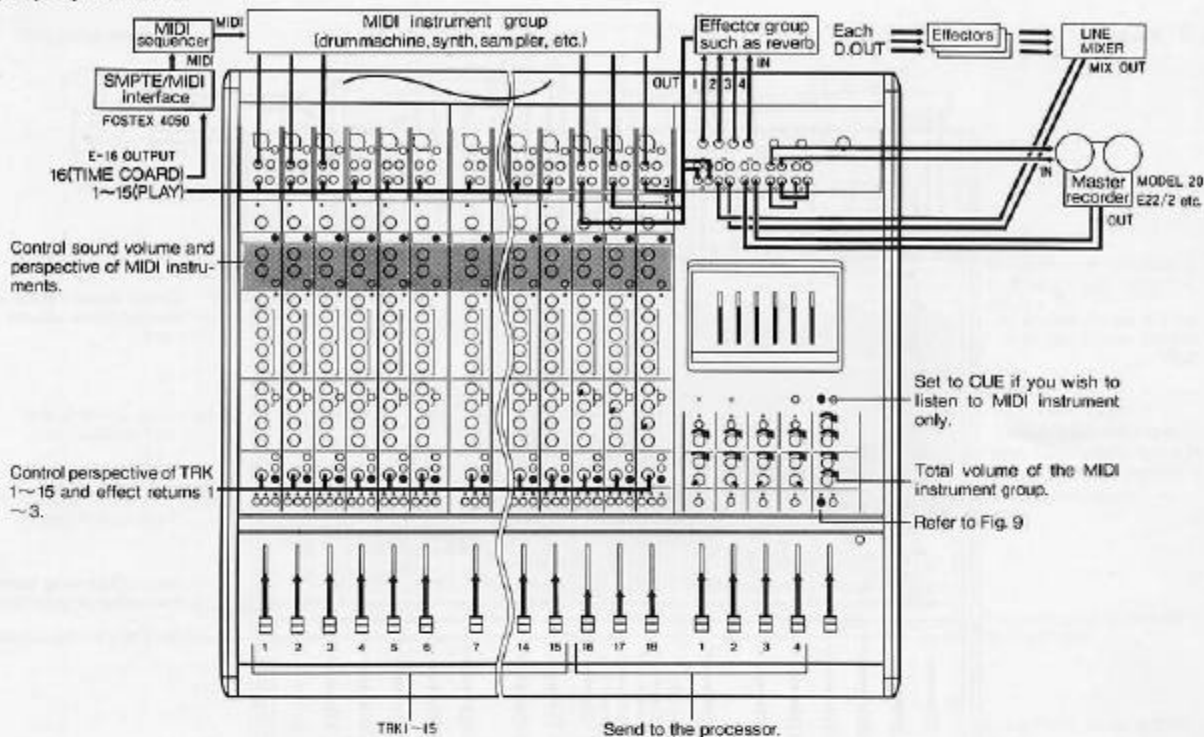

## SECTION 7. OTHER METHODS OF OPERATION

A wide variety of controlling from sound reinforcement by the main speaker to monitor sends to the stage and effect processing are possible when this mixer is used as a PA system mixer in small auditoriums and clubs. In the example of Fig. 11, the outputs of the musical instruments are grouped into (A) and (B), then sent to the main speakers through the GROUP TO STEREO sections (20) and (21). AUX 3, 4 sends (8) are used for sends

to the processor and AUX 1, 2 sends (8) are used for 2 channel stage monitor sends (PRE/POST selector (9) → PRE). In addition, mixed signals of CD, cassette deck, effect outputs, etc. are sent by patching the CUE OUT jack (46) to the GROUP buss 1, 2 and mixed into group (A). The main speaker sound volume is adjusted by the STEREO master fader (22), and total sound volume of the monitor send, by the AUX master GAIN 1 and 2 (23).

Fig. 11 Other methods of operation

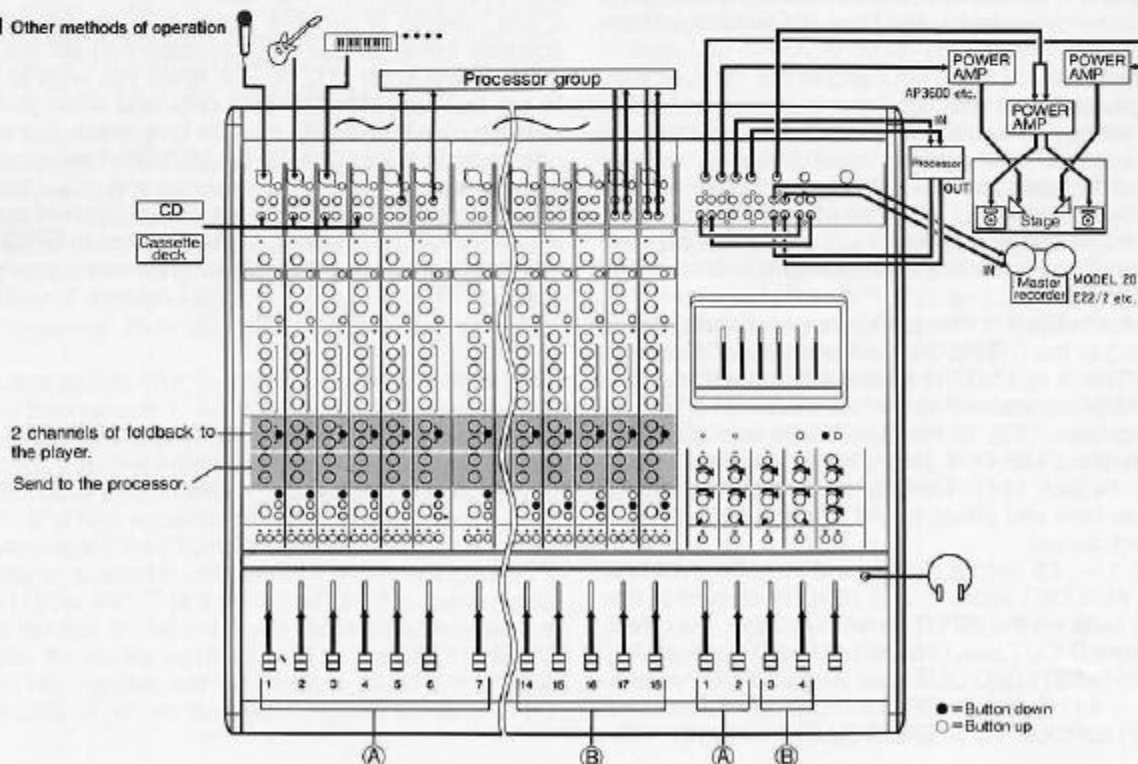

## SECTION 8. TROUBLE SHOOTING

When this mixer fails to operate properly, check the following before concluding there is a breakdown or malfunction.

- **Feedback occurs when a given track is set to input monitor.**

Are you sure the output of the given track is not connected to the buss which is used for the send to this track? Check the signal routing determined by the assign switches (10), (11), (12) and PAN (13), or that of CUE/L-R selector (5) to see that you are not creating a loop.

- **No signal is heard at the INPUT fader (17).**

Are you sure you are not plugging a monaural phone plug into the SEND/RCV jack (37) for that channel? If so, the signal will be sent to the processor but the effect output will not be received.

- **Cannot hear the signal selected by the MONITOR selector (26). Meter (32) L, R does not indicate properly.**

Are you sure the PFL/SOLO LED (48) is not lit? If so, refer again to "NAME AND FUNCTION/OPERATION OF EACH CONTROLS AND SWITCHES" in page 4.

- **CUE is selected by MONITOR selector (26) but no sound is heard. Also can not hear the PFL and SOLO sounds.**

Are the CUE master level knob (31) and/or the PFL/SOLO level knob (30) raised? Are the MONITOR level knob (28) and PHONES level knob (29) raised?

Check these again.

- **No sound from the speaker.**

Is the MONITOR OUT selector (27) properly selected? Check this again.

- **Even though the MUTE button (14) is pressed, sound from this channel is heard.**

Are you sure the PFL button (15) is not pressed or the PRE signal of AUX 1, 2 send (8) is not solo monitored by the AUX SOLO button 1, 2 (24)? Mute is effective only on the signals immediately after the INPUT faders (17).

- **Although sound is faded out by the INPUT fader (17), the processed effect sound of this channel is still heard.**

Are you sure that AUX 1, 2 and (8) is not used for sending to the processor and also that PRE/POST selector (9) is not set to PRE? Set to POST if you wish to link it with the fader.

- **PEAK LED is frequently lit although level had been matched by TRIM (1).**

Did you raise the EQ (7) gain for timbre adjusting after level matching? If so, refer again to "2. Level Matching With External Equipment" in page 7.

- **Sound not assigned to STEREO buss is in the STEREO buss monitor.**

Are you sure the GROUP TO STEREO GAIN 1 ~ 4 is not raised? Set this to  $-\infty$  when it is not required.

## SECTION 9. NOTES ON AFTER SERVICE

1. A warranty card is attached to this product. As the proper items in the warranty card are filled in at the point of purchase, check these items and carefully store it together with Owners Manual.
2. The warranty period is one year from date of purchase. Throughout the warranty period, the Service Section of our organization will repair the product in accordance to content of the warranty. Refer to the warranty card for details.
3. Please consult your store of purchase, nearest Fostex Office or the Service Department in the Fostex head office if you have any questions on repairs after expiration of the warranty period or if the warranty

card cannot be produced.

4. If performance of the product can be maintained by repairing, it will be repaired at cost by request from the user although the warranty has expired.
5. Minimum period of stocking of maintenance and repair parts (parts necessary for maintaining the function of the product) for this product is six years after discontinuation of the product. This period is determined by the Ministry of Commerce and Industry. Addresses and telephone numbers of Fostex Business Offices are listed on the back cover of this Manual.

## SECTION 10. 1240/1840/2440 SPECIFICATIONS

<b>INPUT (× 12 by 1240, × 18 by 1840, × 24 by 2440)</b>		<b>POWER REQUIREMENTS</b>	
Mic impedance	3kΩ or less	1240	33W
Input	7kΩ balanced XLR connector and 16kΩ unbalanced phone jack	1840	37W
		2440	45W
Nominal input level	-60dBV(1mV) ~ -10dBV(0.3V)	<b>DIMENSIONS</b>	
Minimum input level	-70dBV(0.3mV)	1240	120(H)×860(W)×820(D)mm
Maximum input level	+15dBV(5.6V)	1840	120(H)×1135(W)×820(D)mm
<b>TAPE INPUT (× 12 by 1240, × 18 by 1840, × 24 by 2440)</b>		2440	120(H)×1410(W)×820(D)mm
Input impedance	20kΩ	<b>WEIGHT</b>	
Nominal input level	-10dBV(0.3V)	1240	24kg(53 lbs)
Minimum input level	-20dBV(0.1V)	1840	32kg(70 lbs)
Maximum input level	+25dBV(17.8V)	2440	40kg(88 lbs)
<b>GROUP BUSS INPUT (× 4) and MASTER BUSS INPUT (L,R)</b>			
Input impedance	20kΩ		
Nominal input level	-10dBV(0.3V)		
<b>GROUP OUTPUT (× 4)</b>			
Output load impedance	10kΩ or high		
Nominal output level	-10dBV(0.3V)		
Maximum output level	+15dBV(5.6V)		
<b>AUX OUTPUT (× 4) AND CUE (L,R) OUTPUT</b>			
Output load impedance	10kΩ or high		
Nominal output level	-10dBV(0.3V)		
Maximum output level	+15dBV(5.6V)		
<b>STEREO OUTPUT (L,R)</b>			
Output load impedance	10kΩ or high		
Nominal output level	-10dBV(0.3V)		
Maximum output level	+15dBV(5.6V)		
<b>STEREO OUTPUT (L,R) (Phone jack)</b>			
Output load impedance	10kΩ or high		
Nominal output level	+2dBV(1.26V)		
Maximum output level	+15dBV(5.6V)		
<b>MONITOR OUTPUT (L,R)</b>			
Output load impedance	10kΩ or high		
Nominal output level	-10dBV(0.3V)		
Maximum output level	+15dBV(5.6V)		
<b>HEADPHONE OUTPUT</b>			
Output load impedance	8~40Ω		
Maximum output	100mW		
<b>DIRECT OUTPUT (1240 - × 12, 1840 - × 18, 2440 - × 24)</b>			
Output load impedance	10kΩ		
Maximum output level	+15dBV		
<b>FREQUENCY RESPONSE</b>			
Input (Mic)	20~20kHz +1/-2dB		
Line	20~20kHz +1/-1.5dB		
Headphone	30~20kHz +1/-2dB		
<b>EQUIVALENT INPUT NOISE</b>			
Input (Mic)	-125dB unweighted (20~20kHz) -126dB weighted (IEC/ANSI)		
<b>OVERALL SIGNAL TO NOISE</b>			
One mic input	66dB weighted, 65dB unweighted		
12 mic input	52dB weighted, 51dB unweighted		
18 mic input	50dB weighted, 49dB unweighted		
24 mic input	48dB weighted, 47dB unweighted		
<b>T.H.D</b>			
	0.05% at 1kHz nominal level		
Headphone	0.1% at 1kHz 100mW/40Ω		
<b>FADER ATTENUATION</b>	70dB at 1kHz		
<b>CROSSTALK</b>	65dB at 1kHz		
<b>PARAMETRIC EQUALIZER</b>			
	60↔1kHz +15/-15dB		
	400↔6kHz +15/-15dB		
	10kHz +15/-15dB		

# SECTION 11. BLOCK DIAGRAM

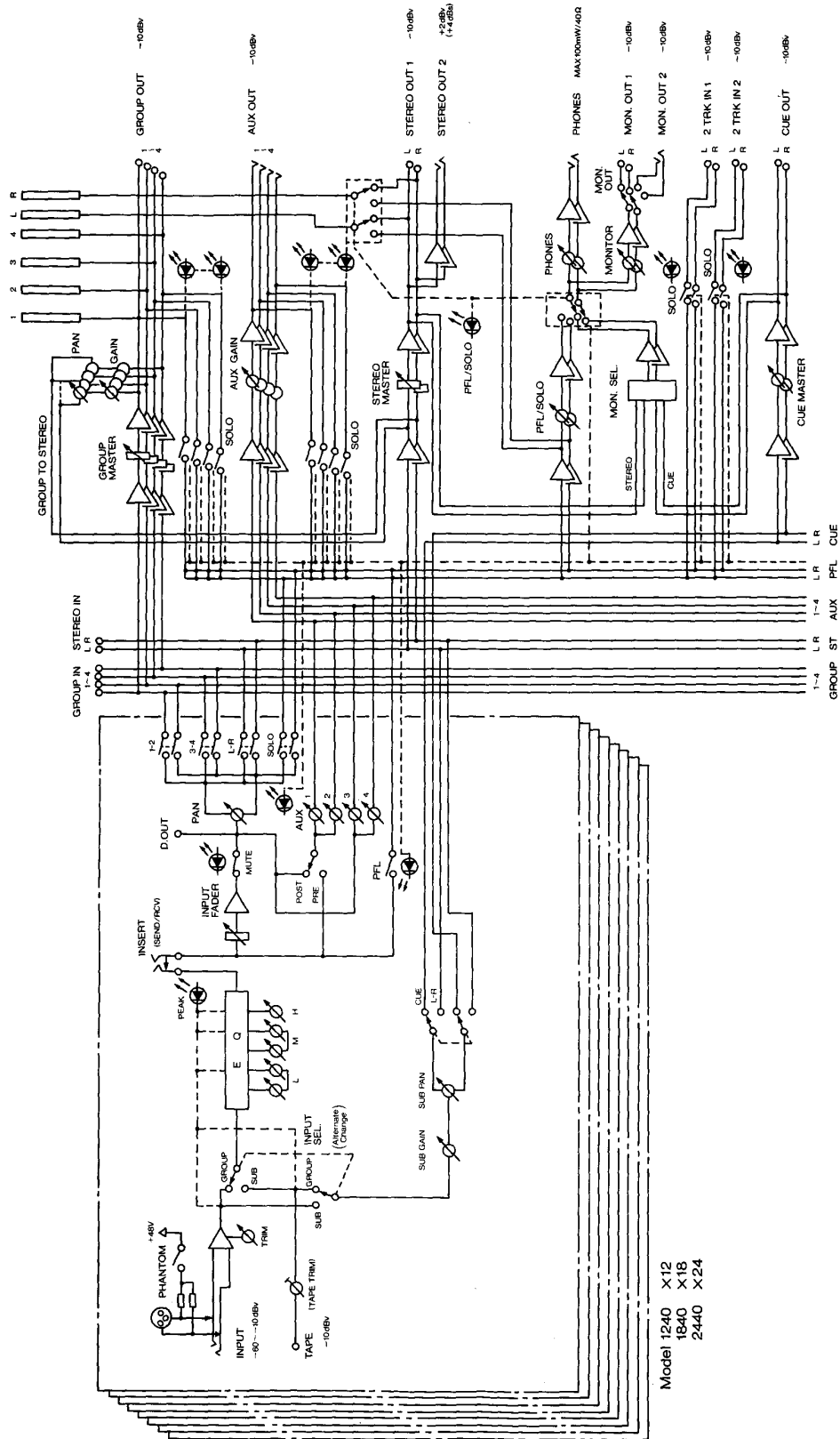

**Fostex**

**FOSTEX CORPORATION** 3-2-35, Musashino, Akishima, Tokyo, Japan

**FOSTEX CORPORATION OF AMERICA** 15431, Blackburn Ave., Norwalk, CA 90650, U.S.A.

©PRINTED IN JAPAN JAN. 1988 8288190000 SG